



**1200W**

**165MM (6 1/2")  
CIRCULAR SAW**

**WITH REDEYE®**

**LS1200**

**INSTRUCTION MANUAL**

**GMC®**

**GLOBAL MACHINERY COMPANY**

Black

Magenta

Code: LS1200

Cyan

Yellow

Date: 070914

Edition: 2

Op: DCR

用本处所有显示的颜色打印包装资料。Print artwork using ALL inks shown here.

# Contents

<b>Warranty</b>	<b>2</b>
<b>Introduction</b>	<b>3</b>
<b>Environmental protection</b>	<b>3</b>
<b>Description of symbols</b>	<b>3</b>
<b>Specifications</b>	<b>3</b>
<b>General safety rules</b>	<b>4</b>
<b>Additional safety rules for laser lights</b>	<b>5</b>
<b>Additional safety rules for circular saws</b>	<b>6</b>
<b>Accessories</b>	<b>7</b>
<b>Unpacking</b>	<b>7</b>
<b>Assembly</b>	<b>7</b>
<b>Know your product</b>	<b>8</b>
<b>Overview</b>	<b>9</b>
<b>Adjusting the cutting depth</b>	<b>9</b>
<b>Adjusting the bevel angle</b>	<b>9</b>
<b>Switching on and off</b>	<b>10</b>
<b>Making a cut</b>	<b>10</b>
<b>Making a pocket cut</b>	<b>10</b>
<b>Using the parallel fence</b>	<b>11</b>
<b>Using the REDEYE® system</b>	<b>11</b>
<b>Changing the blade</b>	<b>12</b>
<b>Maintenance</b>	<b>13</b>
<b>Cleaning</b>	<b>13</b>
<b>General inspection</b>	<b>13</b>
<b>Power cord maintenance</b>	<b>13</b>
<b>Troubleshooting</b>	<b>13</b>

## **Warranty Power Tools**

Whilst every effort is made to ensure your complete satisfaction with this tool, occasionally, due to the mass manufacturing techniques, a tool may not live up to our required level of performance and you may need the assistance of our service department.

This product is warranted for a 2-year period for home domestic use from the date of the original purchase. If found to be defective in materials or workmanship, the tool or the offending faulty component will be repaired or replaced free of charge with another of the same item. A small freight charge may apply. Proof of purchase is essential. We reserve the right to reject any claim where the purchase cannot be verified.

This warranty does not include damage or defects to the tool caused by or resulting from abuse, accidents, alterations or commercial or business use. It also does not cover any bonus items or included accessories. Only the power tool is covered under this warranty.

With continuing product development, changes may have occurred which render the product received slightly different to that shown in this instruction manual.

Please ensure that you store your receipt in a safe place.

Conditions apply to the above warranty. For full details of the warranty terms and conditions please refer to our website – [www.gmcompany.com](http://www.gmcompany.com)

For prompt service we suggest you log your service request online - [www.gmcservice.com.au](http://www.gmcservice.com.au), should you not have access to the internet, please contact our service department on 1300 880 001 (Australia) or 0800 445 721 (New Zealand).

## Introduction

Your new GMC power tool will more than satisfy your expectations. It has been manufactured under stringent GMC Quality Standards to meet superior performance criteria.

You will find your new tool easy and safe to operate, and, with proper care, it will give you many years of dependable service.

**CAUTION.** Carefully read through this entire Instruction Manual before using your new GMC Power Tool. Take special care to heed the Cautions and Warnings.

Your GMC power tool has many features that will make your job faster and easier. Safety, performance, and dependability have been given top priority in the development of this tool, making it easy to maintain and operate.

## Environmental protection



Recycle unwanted materials instead of disposing of them as waste. All tools, hoses and packaging should be sorted, taken to the local recycling centre and disposed of in an environmentally safe way.

## WARNINGS.

1. Do not attempt to change the position of the laser under any circumstances, it has been set at the factory and is accurately focused on the centre of the saw blade.
2. It may be more difficult to see the laser line in conditions of bright sunshine and on certain surfaces.

## Description of symbols

The rating plate on your tool may show symbols. These represent important information about the product or instructions on its use.



Wear hearing protection.

Wear eye protection.



Wear breathing protection.

Double insulated for additional protection.



Conforms to relevant standards for electromagnetic compatibility.

N380

## Specifications

Voltage:	230-240V ~ 50 Hz
Power rating:	1200W
No load speed:	5000 min <sup>-1</sup>
Blade diameter:	165mm (6 1/2")
Blade teeth:	24 TCT
Blade arbour:	16mm
Blade kerf:	2.2mm
Bevel capacity:	0° to 55°
Depth of cut at 90°:	55mm
Depth of cut at 45°:	38mm
Electrical insulation:	Double insulated
Laser class:	Class 2
Weight:	4.1kg

This tool is double insulated. There are two independent barriers of insulation to protect you from the possibility of electric shock.

The sound intensity level for the operator may exceed 105dB(A) and sound protection measures are necessary.

## General safety rules

**WARNING.** Read all instructions. Failure to follow all instructions listed below may result in electric shock, fire and/or serious injury. The term “power tool” in all of the warnings listed below refers to your mains operated (corded) power tool or battery operated (cordless) power tool.

### Save these instructions

#### 1. Work area

- a. **Keep work area clean and well lit.** Cluttered and dark areas invite accidents.
- b. **Do not operate power tools in explosive atmospheres, such as in the presence of flammable liquids, gases or dust.** Power tools create sparks which may ignite the dust or fumes.
- c. **Keep children and bystanders away while operating a power tool.** Distractions can cause you to lose control.

#### 2. Electrical safety

- a. **Power tool plugs must match the outlet.** Never modify the plug in any way. Do not use any adapter plugs with earthed (grounded) power tools. Unmodified plugs and matching outlets will reduce risk of electric shock.
- b. **Avoid body contact with earthed or grounded surfaces such as pipes, radiators, ranges and refrigerators.** There is an increased risk of electric shock if your body is earthed or grounded.
- c. **Do not expose power tools to rain or wet conditions.** Water entering a power tool will increase the risk of electric shock.
- d. **Do not abuse the cord.** Never use the cord for carrying, pulling or unplugging the power tool. Keep cord away from heat, oil, sharp edges or moving parts. Damaged or entangled cords increase the risk of electric shock.

- e. **When operating a power tool outdoors, use an extension cord suitable for outdoor use.** Use of a cord suitable for outdoor use reduces the risk of electric shock.

#### 3. Personal safety

- a. **Stay alert, watch what you are doing and use common sense when operating a power tool.** Do not use a power tool while you are tired or under the influence of drugs, alcohol or medication. A moment of inattention while operating power tools may result in serious personal injury.
- b. **Use safety equipment.** Always wear eye protection. Safety equipment such as dust mask, non-skid safety shoes, hard hat, or hearing protection used for appropriate conditions will reduce personal injuries.
- c. **Avoid accidental starting.** Ensure the switch is in the off position before plugging in. Carrying power tools with your finger on the switch or plugging in power tools that have the switch on invites accidents.
- d. **Remove any adjusting key or wrench before turning the power tool on.** A wrench or a key left attached to a rotating part of the power tool may result in personal injury.
- e. **Do not overreach.** Keep proper footing and balance at all times. This enables better control of the power tool in unexpected situations.
- f. **Dress properly.** Do not wear loose clothing or jewellery. Keep your hair, clothing and gloves away from moving parts. Loose clothes, jewellery or long hair can be caught in moving parts.
- g. **If devices are provided for the connection of dust extraction and collection facilities, ensure these are connected and properly used.** Use of these devices can reduce dust related hazards.

#### 4. Power tool use and care

- a. **Do not force the power tool.** Use the correct power tool for your application. The correct power tool will do the job better and safer at the rate for which it was designed.
  - b. **Do not use the power tool if the switch does not turn it on and off.** Any power tool that cannot be controlled with the switch is dangerous and must be repaired.
  - c. **Disconnect the plug from the power source before making any adjustments, changing accessories, or storing power tools.** Such preventive safety measures reduce the risk of starting the power tool accidentally.
  - d. **Store idle power tools out of the reach of children and do not allow persons unfamiliar with the power tool or these instructions to operate the power tool.** Power tools are dangerous in the hands of untrained users.
  - e. **Maintain power tools.** Check for misalignment or binding of moving parts, breakage of parts and any other condition that may affect the power tools operation. If damaged, have the power tool repaired before use. Many accidents are caused by poorly maintained power tools.
  - f. **Keep cutting tools sharp and clean.** Properly maintained cutting tools with sharp cutting edges are less likely to bind and are easier to control.
  - g. **Use the power tool, accessories and tool bits etc., in accordance with these instructions and in the manner intended for the particular type of power tool, taking into account the working conditions and the work to be performed.** Use of the power tool for operations different from those intended could result in a hazardous situation.
- #### 5. Service
- a. **Have your power tool serviced by a qualified repair person using only identical replacement parts.** This will ensure that the safety of the power tool is maintained.

#### Additional safety rules for laser lights

The laser light/laser radiation used in the GMC REDEYE® system is Class 2 with maximum 1mW and 650nm wavelengths. These lasers do not normally present an optical hazard, although staring at the beam may cause flash blindness.

**WARNING.** Do not stare directly at the laser beam.

A hazard may exist if you deliberately stare into the beam. Please observe all safety rules as follows:

- The laser shall be used and maintained in accordance with the manufacturer's instructions.
- Never aim the beam at any person or an object other than the work piece.
- The laser beam shall not be deliberately aimed at personnel and shall be prevented from being directed towards the eye of a person for longer than 0.25s.
- Always ensure the laser beam is aimed at a sturdy work piece without reflective surfaces, i.e. wood or rough coated surfaces are acceptable. Bright shiny reflective sheet steel or the like is not suitable for laser use as the reflective surface could direct the beam back at the operator.
- Do not change the laser light assembly with a different type. Repairs must only be carried out by the laser manufacturer or an authorised agent.



**CAUTION.** Use of controls or adjustments or performance of procedures other than those specified herein may result in hazardous radiation exposure.

## Additional safety rules for circular saws

**WARNING!** The warnings, precautions, and instructions discussed in this manual cannot cover all possible conditions and situations that may occur. The operator must understand that common sense and caution are factors which cannot be built into this product, but must be supplied by the operator.

## DANGER

### a. Keep hands away from cutting area and the blade.

Keep your second hand on auxiliary handle, or motor housing. If both hands are holding the saw, they cannot be cut by the blade.

**b. Do not reach underneath the workpiece.** The guard cannot protect you from the blade below the workpiece.

**c. Adjust the cutting depth to the thickness of the workpiece.** Less than a full tooth of the blade teeth should be visible below the workpiece.

**d. Never hold piece being cut in your hands or across your leg.** Secure the workpiece to a stable platform. It is important to support the work properly to minimize body exposure, blade binding, or loss of control.

**e. Hold power tool by insulated gripping surfaces when performing an operation where the cutting tool may contact hidden wiring or its own cord.** Contact with a "live" wire will also make exposed metal parts of the power tool "live" and shock the operator.

**f. When ripping always use a rip fence or straight edge guide.** This improves the accuracy of cut and reduces the chance of blade binding.

**g. Always use blades with correct size and shape (diamond versus round) of arbour holes.** Blades that do not match the mounting hardware of the saw will run eccentrically, causing loss of control.

**h. Never use damaged or incorrect blade washers or bolt.** The blade washers and bolt were specially designed for your saw, for optimum performance and safety of operation.

## Causes and operator prevention of kickback:

- Kickback is a sudden reaction to a pinched, bound or misaligned saw blade, causing an uncontrolled saw to lift up and out of the workpiece toward the operator;
- When the blade is pinched or bound tightly by the kerf closing down, the blade stalls and the motor reaction drives the unit rapidly back toward the operator;
- If the blade becomes twisted or misaligned in the cut, the teeth at the back edge of the blade can dig into the top surface of the wood causing the blade to climb out of the kerf and jump back toward the operator.

Kickback is the result of saw misuse and/or incorrect operating procedures or conditions and can be avoided by taking proper precautions as given below.

**a. Maintain a firm grip with both hands on the saw and position your arms to resist kickback forces.** Position your body to either side of the blade, but not in line with the blade. Kickback could cause the saw to jump backwards, but kickback forces can be controlled by the operator, if proper precautions are taken.

**b. When blade is binding, or when interrupting a cut for any reason, release the trigger and hold the saw motionless in the material until the blade comes to a complete stop.** Never attempt to remove the saw from the work or pull the saw backward while the blade is in motion or kickback may occur. Investigate and take corrective actions to eliminate the cause of blade binding.

**c. When restarting a saw in the workpiece, centre the saw blade in the kerf and check that saw teeth are not engaged into the material.** If saw blade is binding, it may walk up or kickback from the workpiece as the saw is restarted.

**d. Support large panels to minimise the risk of blade pinching and kickback.** Large panels tend to sag under their own weight. Supports must be placed under the panel on both sides, near the line of cut and near the edge of the panel.

- e. **Do not use dull or damaged blades.** Unsharpened or improperly set blades produce narrow kerf causing excessive friction, blade binding and kickback.
- f. **Blade depth and bevel adjusting locking levers must be tight and secure before making cut.** If blade adjustment shifts while cutting, it may cause binding and kickback.
- g. **Use extra caution when making a “plunge cut” into existing walls or other blind areas.** The protruding blade may cut objects that can cause kickback.

**The protruding blade may cut objects that can cause kickback.**

- a. **Check lower guard for proper closing before each use.** Do not operate the saw if lower guard does not move freely and close instantly. Never clamp or tie the lower guard into the open position. If saw is accidentally dropped, lower guard may be bent. Raise the lower guard with the retracting handle and make sure it moves freely and does not touch the blade or any other part, in all angles and depths of cut.
- b. **Check the operation of the lower guard spring.** If the guard and the spring are not operating properly, they must be serviced before use. Lower guard may operate sluggishly due to damaged parts, gummy deposits, or a build-up of debris.
- c. **Lower guard should be retracted manually only for special cuts such as “plunge cuts” and “compound cuts.”** Raise lower guard by retracting handle and as soon as blade enters the material, the lower guard must be released. For all other sawing, the lower guard should operate automatically.
- d. **Always observe that the lower guard is covering the blade before placing saw down on bench or floor.** An unprotected, coasting blade will cause the saw to walk backwards, cutting whatever is in its path. Be aware of the time it takes for the blade to stop after switch is released.
- e. **Do not use abrasive wheels,** doing so will void the warranty

## Accessories

The GMC LS1200 Circular Saw is supplied with the following accessories as standard:

1. Blade (fitted)
2. Blade wrench
3. Rip fence
4. Instruction manual

## Unpacking

Due to modern mass production techniques, it is unlikely that your GMC Power Tool is faulty or that a part is missing. If you find anything wrong, do not operate the tool until the parts have been replaced or the fault has been rectified. Failure to do so could result in serious personal injury.

## Assembly

The GMC circular saw is packed, fully assembled except for the rip fence.

## Know your product

1. Laser light assembly
2. Laser light on/off button
3. Laser light aperture
4. Trigger switch
5. Lock-off button
6. Motor housing
7. Main handle
8. Front handle
9. Bevel adjustment knob
10. Bevel scale
11. Parallel fence locking knob
12. Parallel fence
13. Blade guard lever
14. Lower blade guard
15. Base plate
16. Upper blade guard
17. Dust extraction port
18. Depth locking lever
19. Depth of cut indicator
20. Spindle lock button
21. Blade
22. Blade wrench
23. Blade guide notch
24. Parallel fence slots
25. Blade rotation indicator

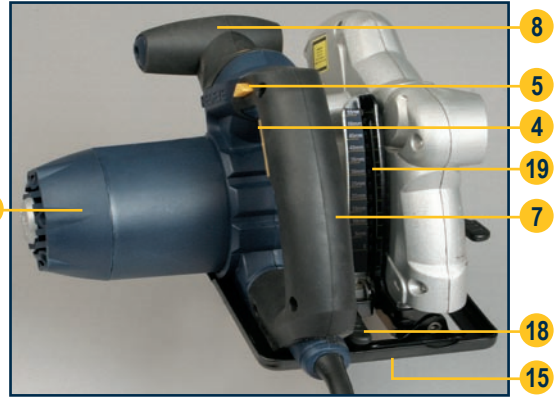
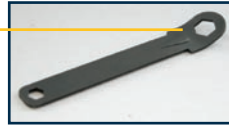



## Overview

You have purchased a 1200W Magnesium Circular Saw with the GMC REDEYE® laser line generator system.

Please refer to the safety instructions given earlier in this manual for important instructions regarding the use of the laser.

The saw is capable of ripping and cross cutting hardwoods, softwoods and man made boards quickly, accurately and safely.

By loosening the bevel adjustment knob (9), the body and the blade of the saw can be tilted to any angle up to 55° for making angle cuts. Please note that the maximum depth of cut is reduced when cutting at an angle.

A fixed upper blade guard (16) encloses the upper part of the blade. As the saw advances through the work piece, the pivoting lower blade guard (14) is pushed back by the edge of the wood to expose only that part of the blade which is needed. When the blade clears the work, the spring loaded lower blade guard snaps back to completely enclose the blade.

## Adjusting the cutting depth

**CAUTION.** Always ensure that the saw is switched off and unplugged from the power supply before making any adjustments.

1. Ensure that the saw is facing away from you.
2. Loosen the depth locking lever (18) (Fig. A).
3. Hold the base plate flat against the edge of the work piece and lift the body of the saw until the blade is at the right depth (Fig. B). Use the depth of cut indicator (19) to determine the cutting depth.

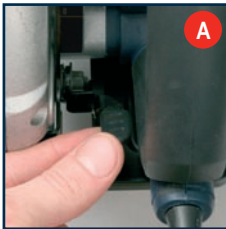

4. Tighten the depth locking lever (18).

**Note.** Always use the correct blade depth setting.

The correct blade depth setting for all cuts should not be more than (6.35mm) 1/4" below the material being cut. Allowing more depth will increase the chance of kickback and result in a rough cut.

## Adjusting the bevel angle

**CAUTION.** Always ensure that the saw is switched off and unplugged from the power supply before making any adjustments.

1. The saw can be adjusted to cut at any angle between 0° and 55°. When making 45° bevel cuts, there is a notch (23) in the saw base to help you line up the blade with the line of cut. Align your line of cut with the inner blade guide notch on the base of the saw when making 45° bevel cuts.
2. Loosen the bevel adjustment knob (9) located at the front of the base plate (Fig. C).

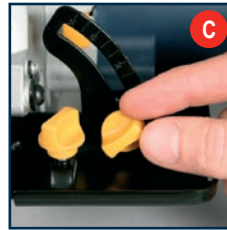

3. Tilt the body of the saw until the required angle is reached (Fig. D) using the bevel scale (10) as a guide.
4. Tighten the bevel adjustment knob (9) to secure the base plate (Fig. E).

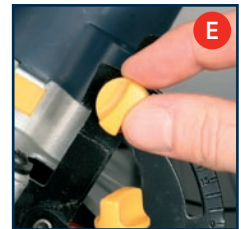

**Note.** Always make a trial cut in a scrap piece of material along a guideline to determine how much you should offset the blade from the guideline to make an accurate cut.

## Switching on and off

1. Connect the plug to the power supply.
2. Depress the lock-off button (5) (Fig. F) and squeeze the trigger switch (4) (Fig. G).



3. The blade will take approximately 2 seconds to reach full speed.
4. When you release the trigger, the machine turns off and the lock-off button re-engages to prevent accidental operation.

**CAUTION.** Allow the blade to come to a complete standstill before setting the saw down.

## Making a cut

1. Mark the line of cut on the work piece.
2. Adjust the depth of cut and bevel angle as required.
3. When making 90° cross or rip cuts, align your line of cut with the outer blade guide notch on the base of the saw (Fig. H).
4. When making 45° bevel cuts, align your line of cut with the inner blade guide notch on the base of the saw.
5. Rest the front edge of the base on the work piece (Fig. I).

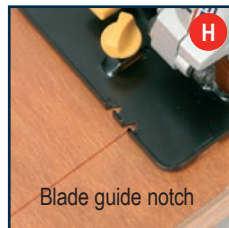

6. Start the motor by depressing the lock-off button (5) and squeezing the trigger switch (4).

**Note.** Always let the blade reach full speed (approximately 2 seconds).

**Note.** Ensure the blade is not touching the work piece at start up otherwise kickback will occur, resulting in damaging the work piece.

7. Slowly push the saw forward using both hands (Fig. J).
8. When making a cut always use steady, even pressure. Forcing the saw causes rough cuts and could shorten the life of the saw or cause kickback. Allow the blade and the saw to do the work.
9. After completing your cut, release the trigger switch and allow the blade to come to a complete stop. Do not remove the saw from the work piece while the blade is moving.

**Note.** Since blade thickness varies, always make a trial cut in scrap material along the guideline to determine how much, if any, the guideline must be offset to get an accurate cut.

## Making a pocket cut

1. Adjust the depth of cut as required.
2. Adjust the bevel setting to 0°.
3. Raise the lower blade guard lever (13) to expose the saw blade and firmly rest the front of the base flat against the work piece with the rear handle raised so the blade does not touch the work piece (Fig. K).

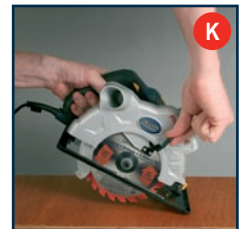

4. With the blade just clearing the work piece, start the motor by depressing the lock-off button (5) and squeezing the trigger switch (4).
5. Always let the blade reach full speed (approximately 2 seconds) before you begin to cut into the work piece.
6. Slowly lower the saw into the work piece, using the front of the base resting on the work piece as a hinge point.

**WARNING.** As soon as the blade starts cutting the material, release the lower blade guard lever.

7. Once the base plate (15) is flat against the work piece, proceed cutting in a forward direction to the end of the cut.
8. After completing your cut, release the trigger switch and allow the blade to come to a complete stop. Do not remove the saw from the work piece while the blade is moving.

**Note.** If the corners of your pocket cut are not completely cut through, use a jigsaw or hand saw to finish the corners.

**Note.** This can be a dangerous cut and is recommended for experienced operators only.

## Using the parallel fence

The parallel fence (12) allows you to make parallel cuts in a sheet of wood, all at the same width.

**CAUTION.** Always ensure that the saw is switched off and unplugged from the power supply before making any adjustments.



1. Loosen the parallel fence locking knob (11) (Fig. L).
2. Slide the parallel fence (12) through the parallel fence slots (24) in the base plate (15) (Fig. M).

3. Adjust the parallel fence to the required width and secure it in position with the parallel fence locking knob (11).
4. Ensure that the parallel fence rests against the wood along its entire length to give a consistent parallel cut (Fig. N).



## Using the REDEYE® system

**WARNING.** Before proceeding to use the REDEYE® laser line system, ensure that the **Additional safety rules for laser lights** section is read and fully understood.

Always ensure the laser beam is aimed at a sturdy work piece without reflective surfaces. i.e. wood or rough coated surfaces are acceptable. Bright shiny reflective sheet steel or the like is not suitable for laser use as the reflective surface could direct the beam back at the operator.

Only turn laser beam on when tool is on work piece.

1. Mark the line of the cut on the work piece.
2. Adjust the depth of cut and bevel angle as required.
3. Rest the front edge of the base on the work piece.
4. Switch on the laser beam using the laser light on/off button (2) (Fig. O).
5. Align the beam with the line on the work piece (Fig. P).

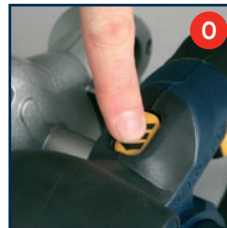

6. Start the motor by depressing the lock-off button (5) and squeezing the trigger switch (4).
7. Always let the blade reach full speed (approximately 2 seconds) before you begin to cut into the work piece.
8. Slowly push the saw forward using both hands, keeping the red laser light beam on the line of cut.
9. After completing your cut, release the trigger switch and allow the blade to come to a complete stop. Do not remove the saw from the work piece while the blade is moving.
10. Switch off the laser beam on completion of the cut.

**Note.** The laser generated line is preset to align with the left side of the blade (closest to the motor).

## Changing the blade

**CAUTION.** Always ensure that the saw is switched off and unplugged from the power supply before making any adjustments.

1. Place saw on its side on a flat surface.
2. Rotate the saw blade by hand whilst depressing the spindle lock button (20) until the blade locks (Fig. Q).
3. Whilst depressing the spindle lock button, turn the blade bolt anti-clockwise using the wrench provided (Fig. R).



4. Remove the outer blade flange and the blade bolt.
5. Raise the lower blade guard (14) using the blade guard lever (13).

6. Remove the saw blade from the inner flange and pull it out (Fig. S).
7. Clean the saw blade flanges thoroughly before mounting the new saw blade. Wipe a drop of oil onto the inner and outer flange where they will touch the blade.
8. Mount the new saw blade onto the spindle and against the inner flange.
9. Replace the outer flange and tighten the blade bolt (Fig. T).



**WARNING.** The direction in which the blade rotates has to be the same as the direction of the arrow marked on the housing (25).

10. Ensure that the spindle lock button (20) is released.
11. Before using the saw again, check that the safety devices are in good working order.

**IMPORTANT.** After replacing the saw blade, make sure that the saw blade runs freely by turning the blade by hand.

12. Plug the machine into a power socket and run the saw under no load to check that it runs smoothly before using it to cut any material.

If purchasing a replacement blade, you may find that the exact blade diameter is not available.

This saw is designed to accept 160mm blade diameter also. Ensure the arbor diameter is 16mm.

**IMPORTANT:** This blade will not take larger blades than 165mm or smaller than 160mm.

## Maintenance

**WARNING.** Always ensure that the tool is switched off and the plug is removed from the power point before making any adjustments or maintenance procedures.

## Cleaning

1. Keep the tool's air vents unclogged and clean at all times.
2. Remove dust and dirt regularly. Cleaning is best done with a rag.
3. Re-lubricate all moving parts at regular intervals.
4. If the body of the saw needs cleaning, wipe it with a soft damp cloth. A mild detergent can be used but nothing like alcohol, petrol or other cleaning agent.
5. Never use caustic agents to clean plastic parts.

**CAUTION.** Do not use cleaning agents to clean the plastic parts of the tool. A mild detergent on a damp cloth is recommended. Water must never come into contact with the tool.

## General inspection

Regularly check that all the fixing screws are tight. They may vibrate loose over time.

## Power cord maintenance

If the supply cord needs replacing, the task must be carried out by the manufacturer, the manufacturer's agent, or a qualified electrical service repairer to avoid a safety hazard.

## Troubleshooting

Trouble	Problem	Suggested remedy
Saw will not start	Power cord not plugged in	Ensure that the cord is connected to the power supply
	Power fault, fuse or circuit breaker tripped	Check the power supply
	Cord damaged	Use authorised service centre to repair or replace
	Burned out switch	Use authorised service centre to repair or replace
	Faulty motor	Use authorised service centre to repair or replace the motor
Blade does not reach full speed	Tool is overheating	Turn off the tool and let it cool down to room temperature. Inspect and clean the ventilation slots
Poor cutting	Blunt blade	Replace or sharpen circular saw blade
Vibration or abnormal noise	Loose parts	Check to see that all knobs and levers are securely tightened including bevel adjustment knob, depth locking lever and parallel fence locking knob
	Blade vibrating	Ensure that the blade nut is securely tightened
	Moving parts excessively worn	Use a qualified electrical service repairer to repair or replace





---

# GMC customer assist

---

Attach Your  
Receipt Here

**If your product needs repairing, replacing, technical service or you simply need help or advice, please contact us on our Customer Assist Line 1300 880 001 (Australia) or 0800 445 721 (New Zealand).**

For prompt service we suggest you log your service request online at [www.gmcservice.com.au](http://www.gmcservice.com.au). Should you not have access to the Internet, please contact our service department on **1300 880 001 (Australia) or 0800 445 721 (New Zealand)**.  
7am – 7pm, 7 days a week (AEST).

---

**Please note that if repair or replacement is required, you must provide a valid original purchase receipt.**

---

You will need the following details at hand to log your service request;

**Personal details:** First & Last name, address, pick up address, contact phone numbers, email address

**Product details:** Product number, date of purchase, retailer bought from, State & postcode, receipt number, reason for the request, copy of official purchase receipt

Attach your purchase receipt and save with this Manual for future reference.

Please refer to our website [www.gmcompany.com](http://www.gmcompany.com) for full GMC warranty Terms and Conditions.

***GMC***<sup>®</sup>  
***GLOBAL MACHINERY COMPANY***