

INSTRUCTION MANUAL

VM-6609

VM-6612

VM-6614

VM-6619

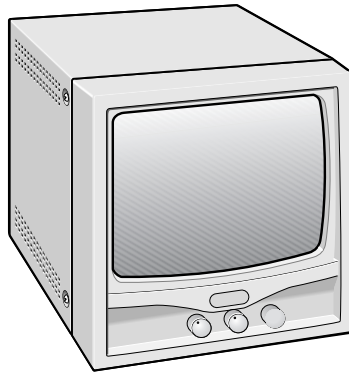

B/W Video Monitor





INFORMATION TO USER

WARNING:

TO REDUCE THE RISK OF FIRE OR ELECTRIC SHOCK, DO NOT EXPOSE THIS PRODUCT TO RAIN OR MOISTURE.
DO NOT INSERT ANY METALLIC OBJECT THROUGH THE VENTILATION GRILLS.

	CAUTION RISK OF ELECTRIC SHOCK DO NOT OPEN	
<p>CAUTION: TO REDUCE THE RISK OF ELECTRIC SHOCK. DO NOT REMOVE COVER (OR BACK). NO USER-SERVICEABLE PARTS INSIDE. REFER SERVICING TO QUALIFIED SERVICE PERSONNEL.</p>		

Explanation of graphical Symbols

	The lightning flash with arrowhead symbol, within an equilateral triangle, is intended to alert the user to the presence of uninsulated “dangerous voltage” within the product’s enclosure that may be of sufficient magnitude to constitute a risk of electric shock to persons.
	The exclamation point within an equilateral triangle is intended to alert the user to the presence of important operating and maintenance (servicing) instructions in the literature accompanying the product.

FCC COMPLIANCE STATEMENT

FCC INFORMATION: THIS EQUIPMENT HAS BEEN TESTED AND FOUND TO COMPLY WITH THE LIMITS FOR A CLASS A DIGITAL DEVICE, PURSUANT TO PART 15 OF THE FCC RULES. THESE LIMITS ARE DESIGNED TO PROVIDE REASONABLE PROTECTION AGAINST HARMFUL INTERFERENCE WHEN THE EQUIPMENT IS OPERATED IN A COMMERCIAL ENVIRONMENT. THIS EQUIPMENT GENERATES, USES, AND CAN RADIATE RADIO FREQUENCY ENERGY AND IF NOT INSTALLED AND USED IN ACCORDANCE WITH THE INSTRUCTION MANUAL, MAY CAUSE HARMFUL INTERFERENCE TO RADIO COMMUNICATIONS. OPERATION OF THIS EQUIPMENT IN A RESIDENTIAL AREA IS LIKELY TO CAUSE HARMFUL INTERFERENCE IN WHICH CASE THE USER WILL BE REQUIRED TO CORRECT THE INTERFERENCE AT HIS OWN EXPENSE.

CAUTION: CHANGES OR MODIFICATIONS NOT EXPRESSLY APPROVED BY THE PARTY RESPONSIBLE FOR COMPLIANCE COULD VOID THE USER’S AUTHORITY TO OPERATE THE EQUIPMENT.

THIS CLASS A DIGITAL APPARATUS MEETS ALL REQUIREMENTS OF THE CANADIAN INTERFERENCE-CAUSING EQUIPMENT REGULATIONS.

CET APPAREIL NUMÉRIQUE DE LA CLASSE A RESPECTE TOUTES LES EXIGENCES DU RÈGLEMENT CANADIEN SUR LE MATÉRIEL CAUSANT DES INTERFÉRENCES.

IMPORTANT SAFEGUARDS

1. **READ INSTRUCTIONS** -- All the safety and operating instructions should be read before the appliance is operated.
2. **RETAIN INSTRUCTIONS** -- The safety and operating instructions should be retained for future reference.
3. **CLEANING** -- Unplug video monitor or equipment from the wall outlet before cleaning. Do not use liquid cleaners or aerosol cleaners. Use a damp cloth for cleaning.
4. **ATTACHMENT** -- Do not use attachments not recommended by the video monitor or equipment manufacturer as they may result in the risk of fire, electric shock or injury to persons.
5. **WATER AND MOISTURE** -- Do not use the video monitor or equipment near water -- for example, near a bathtub, washbowl, kitchen sink, laundry tub, in a wet basement, or near a swimming pool, or the like.
6. **ACCESSORIES** -- Do not place video monitor or equipment on an unstable cart, stand or table. The video monitor or equipment may fall, causing serious injury to a child or adult, and serious damage to the equipment. Wall or shelf mounting should follow the manufacturer's instructions, and should use a mounting kit approved by the manufacturer.
- 6A. Video monitor or equipment and cart combinations should be moved with care. Quick stops, excessive force, and uneven surfaces may cause the equipment and cart combination to overturn. 
7. **VENTILATION** -- Slots and openings in the cabinet and the back or bottom are provided for ventilation, and to ensure reliable operation of the video monitor or equipment and to protect it from overheating. These openings must not be blocked or covered. The openings should never be blocked by placing the video monitor or equipment on a bed, sofa, rug, or other similar surface. Video monitor or equipment should never be placed near or over a radiator or heat register. Video monitor or equipment receiver should not be placed in a built-in installation such as a bookcase unless proper ventilation is provided.
8. **POWER SOURCES** -- Video monitor or equipment should be operated only from the type of power source indicated on the marking label. If you are not sure of the type of power supplied to your home, consult your video monitor or equipment dealer or local power company. For video monitor or equipment designed to operate from battery power refer to the operating instructions.
9. **GROUNDING OR POLARIZATION** -- This product is equipped with a three-wire grounding-type plug, a plug having a third (grounding) pin. This plug will only fit into a grounding-type power outlet. This is a safety feature. If you are unable to insert the plug into the outlet, contact your electrician to replace your obsolete outlet. Do not defeat the safety purpose of the grounding-type plug.
10. **POWER CORDS** -- Do not allow anything to rest on the power cord. Do not locate video monitor or equipment where the cord will be abused by persons walking on it.
11. **HEED WARNINGS** -- Follow all instructions marked on the video monitor or equipment.
12. **LIGHTNING** -- For added protection for video monitor or equipment during a lightning storm, or when it is left unattended and unused for long periods of time, unplug it from the wall outlet and disconnect the antenna or cable system. This will prevent damage to the video product due to lightning and power-line surges.
13. **OVERLOADING** -- Do not overload wall outlets and extension cords as this can result in a risk of fire or electric shock.
14. **OBJECT AND LIQUID ENTRY** -- Never push objects of any kind into video monitor or equipment through openings as they may touch dangerous voltage points or short-out parts that could result in a fire or electric shock. Never spill liquid of any kind on the product.
15. **SERVICING** -- Do not attempt to service video monitor or equipment yourself as opening or removing covers may expose you to dangerous voltage or other hazards. Refer all servicing to qualified service personnel.
16. **DAMAGE REQUIRING SERVICE** -- Unplug video monitor or equipment from the wall outlet and refer servicing to qualified service personnel under the following conditions.
 - A. When the power-supply cord or the plug has been damaged.
 - B. If liquid has spilled, or objects have fallen into the video product.
 - C. If the video product has been exposed to rain or water.
 - D. If the video product does not operate normally by following the operating instructions, adjust only those controls that are covered by the operating instructions as an improper adjustment of other controls may result in damage and will often require extensive work by a qualified technician to restore the video product to its normal operation.
 - E. If the video product has been dropped, or the cabinet damaged.
 - F. When the video product exhibits a distinct change in performance -- this indicates a need for service.
17. **REPLACEMENT PARTS** -- When replacement parts are required, be sure the service technician has used replacement parts specified by the manufacturer or that have the same characteristics as the original parts. Unauthorized substitutions may result in fire, electric shock or other hazards.
18. **SAFETY CHECK** -- Upon completion of any service or repairs to this video product, ask the service technician to perform safety checks to determine that the video product is in proper operating condition.

PRECAUTION

If an abnormality does occur, turn the power switch off and unplug the unit. Have a qualified technician perform any repairs.

Do not use the monitor if it makes a strange noise, emits a strange odor, or if smoke comes out from it

If used under these conditions, the monitor may cause a fire or electric shock. Immediately unplug it and wait to make sure no more smoke comes from it. Then take it to the dealer for service. Do not try to repair or open the monitor yourself.

Do not allow the power cord to get damaged

- Do not place heavy objects on the power cord.
- Do not place the power cord near a heat source.
- Do not excessively bend the power cord, modify it, or secure it with staples.

Doing so may damage the power cord and cause a fire or electric shock.

If the power cord is damaged, take it to the dealer and have it replaced.

Do not allow dust or dirt to build up on the power cord or power outlet

A build-up of dust may cause a short circuit or generate heat and cause a fire.

Be especially careful when using the monitor in areas of high humidity, in areas with frequent condensation, in kitchens, and in places where there is excessive dust.

Periodically unplug the power cord and clean away the dust that builds up between the plug terminals.

Cautions when plugging in the power cord

- Make sure you insert the plug of the power cord all the way in the power outlet. Using the monitor with the power cord not fully plugged in may cause heat to generate and cause a fire.
- Do not use the monitor with the power cord wound or tied up. Heat may generate and cause a fire.
- When using an extension cord, be sure that the total current load of all equipment connected to it does not exceed the specified ratings of the extension cord. If the ratings are exceeded, heat may generate and cause a fire. Make sure to carefully read the specifications accompanying the extension cord.

Cleaning

- Dirt can be removed from the cabinet by wiping it with a soft cloth. To remove stains, wipe with a soft cloth moistened with a soft detergent solution and wrung dry, then wipe dry with dry soft cloth.
- Do not use benzene, thinner or other chemical product on the cabinet, as that may cause deformation and paint peeling. Before using a chemical cloth, make sure to read all accompanying instructions. Make sure that no plastic or rubber material comes in contact with the cabinet for a long period of time, as that may cause damage or paint peeling.

SERVICE

This unit is a precision instrument and if treated with care, will provide years of satisfactory performance. However, in the event of a problem, the owner is advised not to attempt to make repairs or open the cabinet. Servicing should always be referred to your dealer or Sanyo Authorized Service Centre.

CONTENTS

PARTS NAMES	4
Front Panel	4
Rear Panel	5
CONNECTION	6
Single connection	6
Multiple connection	6
BASIC OPERATION	7
TROUBLESHOOTING	8
SPECIFICATIONS	9

FEATURES

- Universal power (AC 100V to AC 240V) and detachable power cord
- 2 Channel Input - A/B Channel selectable
- Contrast, Bright control on front panel and Sub-bright, V-size, V-hold control on rear panel
- Horizontal resolution
VM-6609, 6612: more than 800 TV line
VM-6614, 6619: more than 1000 TV line

PARTS NAMES

Front Panel

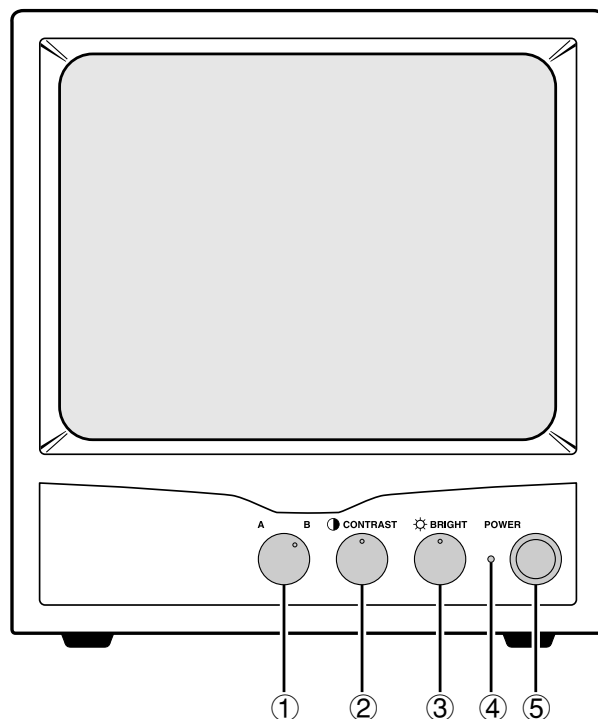

① Monitor Selector Switch (VIDEO A/B)

Turn this Monitor selector switch A position for a signal fed through the rear panel VIDEO A connectors. Then, turn this Monitor selector switch B position for a signal fed through the rear panel VIDEO B connectors.

② Contrast Control (● CONTRAST)

Turn to adjust picture contrast according to your requirement.

③ Brightness Control (☀ BRIGHT)

Turn to adjust picture brightness according to your requirement.

④ Power Indicator

Lights when the power is on.
Lit: When the power is on.
Unlit: When power is off.

⑤ Power Switch (POWER)

Press this switch to turn the power on or off.

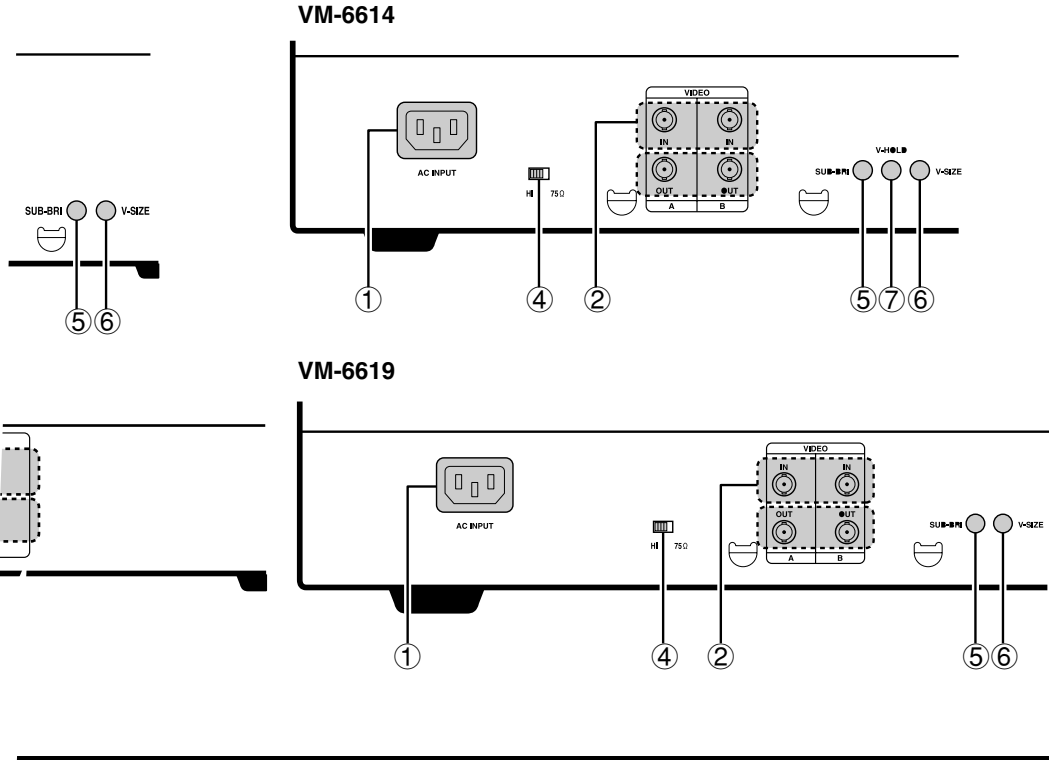
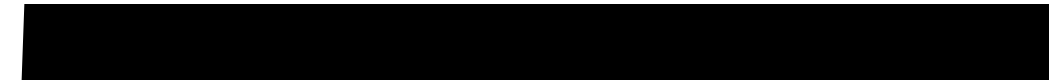

AC INPUT

Power cord (supplied) securely to this AC power outlet.

Video Input Terminals (VIDEO IN)

These terminals are used to input a video signal from a monitor.

Use the video output of a VCR or another monitor (or loop through connection) to a video

Video Output Terminal: (VIDEO OUT)

These terminals are used to output a video signal from this monitor.

Loop-through output of the video in BNC connector, then connect to the video input of another monitor or a VCR.

4 Termination Switch (HI/75Ω (Lo))

Select the input impedance (HI/75Ω).

When using only one monitor, turn the termination switch to the 75Ω position. When using more than one monitor, set all of the termination switch on the monitors to the HI position. However, the last monitor termination switch should be in the 75Ω position for proper line termination.

5 Sub-brightness control (SUB-BRI)

Turn to adjust picture brightness.

6 Vertical Size control (V-SIZE)

Turn to adjust picture vertical size of the picture.

7 Vertical hold control (V-HOLD)

If the picture is scrolling up or down on the screen, turn this control until there is a single steady picture.

CONNECTION

Before connecting your system, make sure that all units are turned off.

The picture signal source can be connected to either the A or B terminal at the rear of the monitor. The monitor selector switch at the front of the monitor can be used to select the input terminal used.

Single Connection

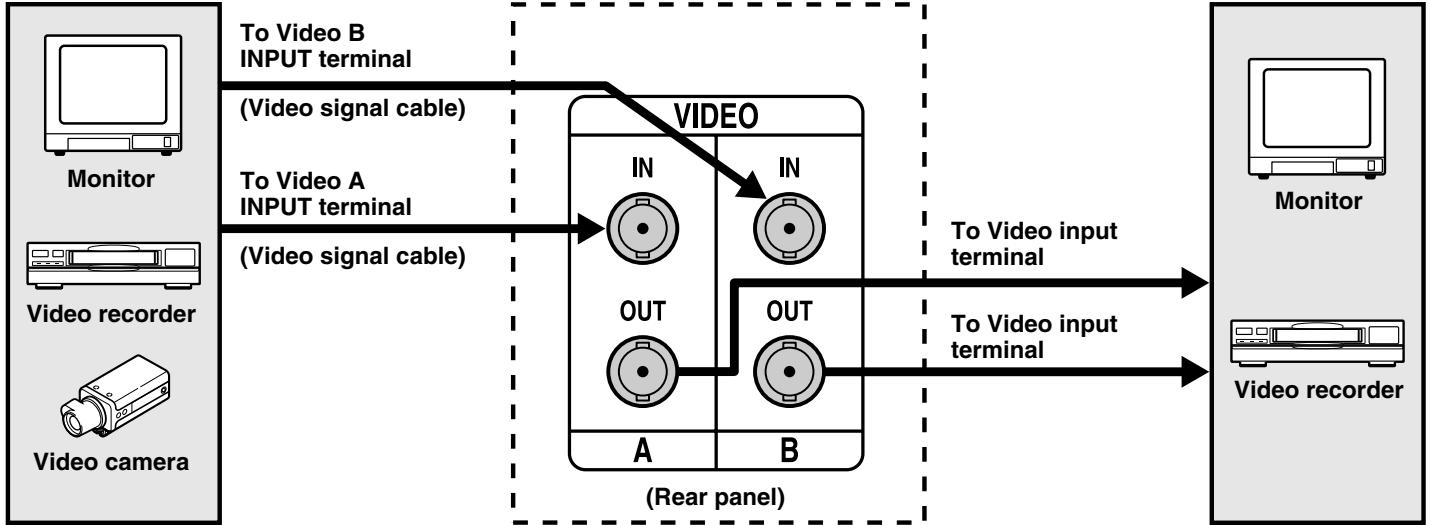

Note: The components and connection cables are not included and must be purchased separately.

Multiple Connection

Multi-connection is possible using the loop-through feature of this unit.

When this monitor is connected to additional monitors, the same picture can be obtained on all the connected monitors. Set the final monitor to 75 Ω termination state.

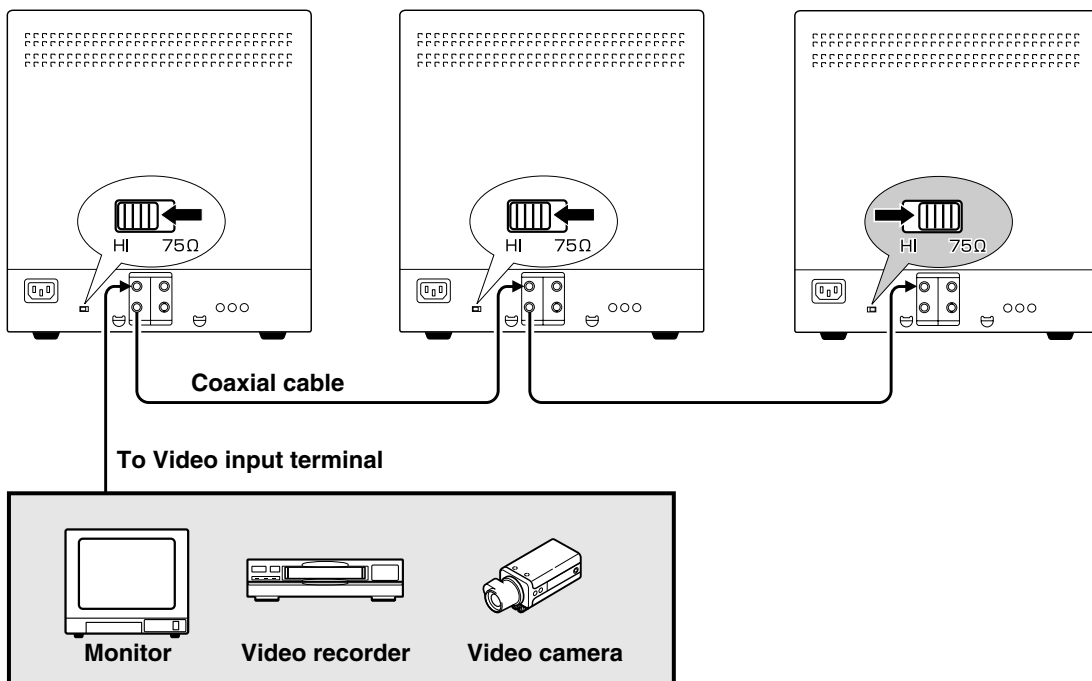

Note:

- Do not leave a unused cable and do not connect BNC connector to the last jack of the monitor. Only once connection.
- The components and connection cables are not included and must be purchased separately.

BASIC OPERATION

1 Press the **POWER** switch to turn on the power.

ON: The power is turned on (the POWER indicator is lit).

OFF: The power is turned off (the POWER indicator is off).

2 Select the picture input.

Use the monitor selector switch at the front of the monitor to select the picture being input to either the A or B input terminal.

NOTE: If there is no input source connected to either the A or B input terminal, no picture will appear when that input terminal is selected.

3 Adjust the picture.

Adjusting the picture brightness

Turn the **BRIGHT** control to the left or right to adjust the picture brightness.

Right: The picture becomes brighter

Left: The picture becomes darker

Adjusting the picture contrast

Turn the **CONTRAST** control to the left or right to adjust the picture contrast.

Right: The picture becomes sharper

Left: The picture becomes softer

TROUBLESHOOTING

Solutions to common problems related to your monitor are described here. If none of the solutions presented here solves the problem, unplug the monitor and consult a SANYO-authorized dealer or service center for assistance.

Problems	Points to be checked	Measures (Remedy)
No power supply.	Is the power plug loosened or disconnected?	Firmly insert the power plug.
No picture with the power on.	Is the video signal output from the connected component?	Set the connected component correctly.
	Is the input signal selected properly?	Select the required video signal input with the Monitor selector switch. (See page 4.)
	Is the video cable disconnected?	Connect the video signal cable firmly. (See page 6.)
Shaking picture.	Is the monitor close to a device generating a strong magnetic field?	Move the device away from the monitor until the picture stabilizes.
Picture is too bright and hard to view.	Has the termination switch been set correctly?	Move the termination switch to the correct setting.

The following are not malfunctions:

- You experience a mild electric shock when you touch the picture tube. This phenomenon is due to a normal buildup of static electricity on the CRT and is not harmful.
- The monitor emits a strange sound when the room temperature changes suddenly. This is only a problem if an abnormality appears on the screen as well.
- If two or more monitors are operated next each other, their images may shake or be distorted. This phenomenon is due to mutual interference; it is not a malfunction.
Move the monitors away from each other until the interference disappears or turn the power off on any monitor that is not being used.

SPECIFICATIONS

	VM-6609	VM-6612	VM-6614	VM-6619
System	EIA standard			
Picture tube	9" measured diagonally, 90° deflection angle	12" measured diagonally, 90° deflection angle	15" measured diagonally, 90° deflection angle	20" measured diagonally, 90° deflection angle
Resolution	More than 800 TV lines (center)		More than 1000 TV lines (center)	
Scanning frequency	Horizontal: 15.75 kHz (EIA) Vertical: 60 Hz (EIA)			
Input terminals				
VIDEO A	Composite video: 1 line, BNC connector, 1.0 Vp-p 75 Ω negative sync			
VIDEO B	Composite video: 1 line, BNC connector, 1.0 Vp-p 75 Ω negative sync			
Output terminals				
VIDEO A	Composite video: 1 line, BNC connector, 1.0 Vp-p 75 Ω negative sync			
VIDEO B	Composite video: 1 line, BNC connector, 1.0 Vp-p 75 Ω negative sync			
Sub Adjusting control	Sub bright volume	Yes	Yes	Yes
	Vertical size volume	Yes	Yes	Yes
	–	Vertical hold volume	Yes	No
Termination switch	Manual switchable Hi/75 Ω (Lo)			
Operating environment	Temperature: –10 to 40°C, Humidity: 10 % to 90 %			
Power Source	AC 100 V ~ 240 V 50/60 Hz			
Power consumption	20 W	30 W	35 W	36 W
Dimensions (W x H x D)	222 x 238 x 250 mm	304 x 320 x 310 mm	350 x 350 x 360 mm	472 x 450 x 360 mm
Weight	4.5 kg	7.5 kg	11 kg	19 kg
Accessory	AC power cord x 1			

Features and specifications are subject to change without prior notice or obligations.

Example: VM6609

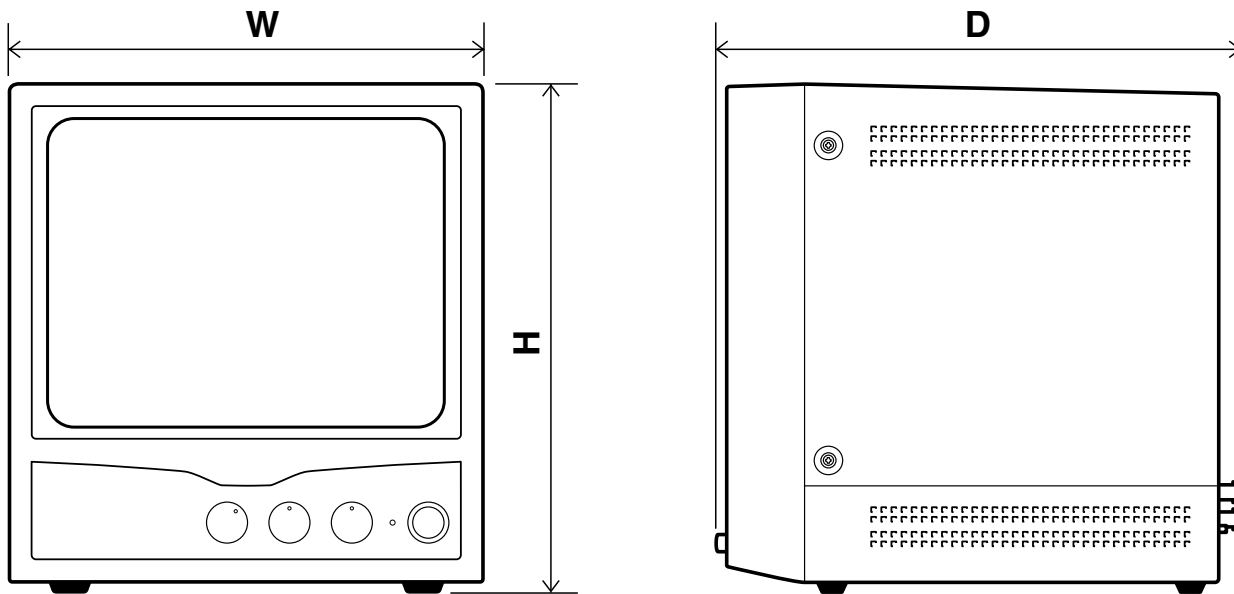

**SANYO INDUSTRIAL VIDEO
VIDEO MONITOR LIMITED WARRANTY**

OBLIGATIONS

In order to obtain warranty service, the product must be delivered to and picked up from an Authorized Sanyo Service Center at the user's expense, unless specifically stated otherwise in this warranty. The names and addresses of Authorized Sanyo Service Centers may be obtained by calling the toll-free number listed below.

For product operation, authorized service center referral, service assistance or problem resolution, call <p style="text-align: center;">CUSTOMER INFORMATION 1-800-421-5013 Weekdays 8:30 AM – 5:00 PM Pacific Time</p>	For accessories and/or parts, call <p style="text-align: center;">PARTS ORDER INFORMATION 1-800-726-9662 Weekdays 8:30 AM – 5:00 PM Pacific Time</p>
---	---

THIS WARRANTY IS VALID ONLY ON SANYO PRODUCTS PURCHASED OR RENTED IN THE UNITED STATES OF AMERICA, EXCLUDING ALL U.S. TERRITORIES AND PROTECTORATES. THIS WARRANTY APPLIES ONLY TO THE ORIGINAL RETAIL PURCHASER OR END-USER. THE ORIGINAL DATED BILL OF SALE, SALES SLIP OR RENTAL AGREEMENT MUST BE SUBMITTED TO THE AUTHORIZED SANYO SERVICE CENTER AT THE TIME WARRANTY SERVICE IS REQUESTED.

Subject to the OBLIGATIONS above and EXCLUSIONS below, SANYO Fisher Company warrants this SANYO product against defects in materials and workmanship for the periods specified below. SFC will repair or replace (at its option) the product and any of its parts which fail to conform to this warranty. The warranty period commences on the date the product was first purchased or rented at retail.

LABOR	PARTS	PICTURE TUBE
1 YEARS	1 YEARS	1 YEARS

EXCLUSIONS

This warranty does not cover (A) the adjustment of customer-operated controls as explained in the appropriate model's instruction manual, or (B) the repair of any product whose serial number has been altered, defaced or removed.

This warranty shall not apply to the cabinet or cosmetic parts, batteries or routine maintenance.

This warranty does not apply to uncrating, setup, installation, removal of the product for repair or reinstallation of the product after repair.

This warranty does not apply to repairs or replacements necessitated by any cause beyond the control of SFC including, but not limited to, any malfunction, defect or failure caused by or resulting from unauthorized service or parts, improper maintenance, operation contrary to furnished instructions, shipping or transit accidents, modification or repair by the user, abuse, misuse, neglect, accident, incorrect power line voltage, fire, flood or other Acts of God, or normal wear and tear.

The foregoing is in lieu of all other expressed warranties and SFC does not assume or authorize any party to assume for it any other obligation or liability.

SFC DISCLAIMS ALL OTHER WARRANTIES EXPRESS OR IMPLIED, WITH REGARD TO THIS PRODUCT (INCLUDING THE WARRANTIES OF MERCHANTABILITY AND FITNESS). IN NO EVENT SHALL SFC BE LIABLE FOR ANY SPECIAL, INCIDENTAL OR CONSEQUENTIAL DAMAGES ARISING FROM THE OWNERSHIP OR USE OF THIS PRODUCT OR FOR ANY DELAY IN THE PERFORMANCE OF ITS OBLIGATIONS UNDER THIS WARRANTY DUE TO CAUSES BEYOND ITS CONTROL. SFC'S LIABILITY FOR ANY AND ALL LOSSES AND DAMAGES RESULTING FROM ANY CAUSE WHATSOEVER, ARISING OUT OF OR IN CONNECTION WITH THE SALE, USE OR OWNERSHIP OF THIS PRODUCT INCLUDING WARRANTOR'S NEGLIGENCE, ALLEGED DAMAGED OR DEFECTIVE GOODS, WHETHER SUCH DEFECTS ARE DISCOVERABLE OR LATENT, SHALL IN NO EVENT EXCEED THE PURCHASE PRICE OF THE PRODUCT.

ATTENTION

For your protection in the event of theft or loss of this product, please fill in the information below for you own personal records.

Model No. _____

Serial No. _____
(Located on back or bottom side of unit.)

Date of Purchase _____

Purchase Price _____

Where Purchased _____