

Owner's Guide

for the



Ampeg

B3 / B328 / B3158

Bass Amplifier



B3



B328



B3158

Made in the U.S.A. by



Ampeg



TABLE OF CONTENTS

- Introduction2
- Features2
- Important Safeguards and Precautions2
- The Front Panel Controls and Their Use3,4
- The Rear Panel4,5
- Some Suggested Settings6
- Troubleshooting7
- System Block Diagram7
- Technical Specificationsback cover

An Introduction to your new Ampeg Bass Amplifier

Thank you for making one of the best choices you will ever make for your musical career – choosing one of the finest bass amps available, an Ampeg B3/B328/B3158.

Your new bass amplifier offers many outstanding features. One hundred fifty watts of pure bass energy, total tone control, and rugged construction make each a true performer's bass amp.

Important Safeguards and Precautions

All Ampeg products are designed for continuous safe operation, as long as common sense is used and steps are taken to help avoid certain problems. Abiding by the following rules can help prevent damage to your amplifier, yourself and others.

- The amplifier is equipped with a three-pronged AC power cord. To reduce the risk of electrical shock, **NEVER** remove or otherwise attempt to defeat the ground pin of the power cord.
- Connect the amplifier **ONLY** to a properly grounded AC outlet of the proper voltage for your amp.
- Avoid sudden temperature extremes, rain and moisture. Also, avoid sudden and intense impact. (If the unit has been subjected to any of the preceding abuses, have it looked at by an authorized service center.)
- **NEVER** set the amplifier on a support that might give out under its weight.
- Whenever using tall or stacked speaker cabinets, use them **ONLY** on a level surface. **NEVER** set tall or stacked cabinets on a surface with more than a five degree incline since tipping or falling could occur, possibly causing serious injuries.
- Always keep the total speaker impedance at or above the rated load.
- Unplug the amplifier before cleaning it. **NEVER** spray liquid cleaners onto the amplifier. Wipe it with a slightly dampened, lint-free cloth to remove dirt and film.
- Don't use the amplifier if it has sustained damage to the chassis, controls, or power cord. Refer the unit to an authorized service center for inspection.
- Amplifiers capable of producing high volume levels are also capable of inflicting permanent hearing loss or damage, if the exposure to such levels is prolonged. Such damage is progressive and irreversible!

Features

In the world of high performance bass amps, Ampeg amplifiers stand alone. In true Ampeg tradition, your new B3/B328/B3158 offers you more power, performance and flexibility than any other bass amplifier in its class. The outstanding features of your new amplifier, features which set it apart from the competition, are listed below:

- **9-BAND GRAPHIC EQ:** Use as a "second channel" for bass solos, or to shape the sound to your own exacting standards. An independent level control lets you adjust the Graphic EQ volume
- **BALANCED LINE OUTPUTS:** Independent level control. XLR type jack to patch into house consoles, mixing boards, or external power amplifiers
- **EFFECTS LOOP:** Connect your effects here for increased intensity and quieter operation
- **DRIVE CONTROL:** To add harmonics for tube-like overdrive
- **BALANCE CONTROL (B3158 only):** To fine tune the mix between the Biamp High and Biamp Low outputs

CAUTION

RISK OF ELECTRIC SHOCK
DO NOT OPEN

CAUTION: TO REDUCE THE RISK OF ELECTRIC SHOCK, DO NOT REMOVE COVER. NO USER-SERVICEABLE PARTS INSIDE. REFER SERVICING TO QUALIFIED SERVICE PERSONNEL.

ATTENTION

RISQUE D'ELECTROCUTION
NE PAS OUVRI

ATTENTION: POUR REDUIRE D'ELECTROCUTION NE PAS ENLEVER LE COUVERCLE. AUCUNE PIECE INTERNE N'EST REPRABLE PAR L'UTILISATEUR. POUR TOUTE REPARATION, S'ADRESSER A UN TECHNICIEN QUALIFIE.

VORSICHT

ELEKTRISCHE SCHLAGEGFAHR
NICHT OFFENEN

VORSICHT: ZUR MINIMIERUNG ELEKTRISCHER SCHLAGEGFAHR NICHT DEN DECKEL ABENHMEN. INTERNE TEILE KONNEN NICHT VOM BENUTZER GEWARTET WERDEN. DIE WARTUNG IS QUALIFIZIERTEM WARTUNGSPERSONAL ZU UBERLASSEN.

THIS EQUIPMENT HAS BEEN DESIGNED AND ENGINEERED TO PROVIDE SAFE AND RELIABLE OPERATION. IN ORDER TO PROLONG THE LIFE OF THE UNIT AND PREVENT ACCIDENTAL DAMAGES OR INJURY, PLEASE FOLLOW THESE PRECAUTIONARY GUIDELINES:

WARNING: TO REDUCE THE RISK OF ELECTRIC SHOCK, DO NOT OPEN CHASSIS; DO NOT DEFEAT OR REMOVE THE GROUND PIN OF THE POWER CORD; CONNECT ONLY TO A PROPERLY GROUNDED AC POWER OUTLET.

CAUTION: TO REDUCE THE RISK OF FIRE OR ELECTRIC SHOCK, DO NOT EXPOSE THIS EQUIPMENT TO RAIN OR MOISTURE.

CAUTION: NO USER-SERVICEABLE PARTS INSIDE. REFER SERVICING TO QUALIFIED SERVICE PERSONNEL.

CAUTION: OUR AMPLIFIERS ARE CAPABLE OF PRODUCING HIGH SOUND PRESSURE LEVELS. CONTINUED EXPOSURE TO HIGH SOUND PRESSURE LEVELS CAN CAUSE PERMANENT HEARING IMPAIRMENT OR LOSS. USER CAUTION IS ADVISED AND EAR PROTECTION IS RECOMMENDED IF UNIT IS OPERATED AT HIGH VOLUME. The chart below shows the U.S. Government Occupational Safety and Health Administration (OSHA) regulations which were in effect at the time of this publication for permissible noise exposure, per 29CRF1910, Table G-16.

SOUND LEVEL dBA SLOW RESPONSE	DURATION PER DAY IN HOURS	SOUND LEVEL dBA SLOW RESPONSE	DURATION PER DAY IN HOURS
90	8	102	1-1/2
92	6	105	1
95	4	110	1/2
97	3	115	1/4 or less
100	2		

According to OSHA, any exposure in excess of those listed above could result in some hearing loss.

EXPLANATION OF GRAPHICAL SYMBOLS:



"DANGEROUS VOLTAGE"
"DANGER HAUTE TENSION"
"GEFAHLICHE SPANNUNG"



"IT IS NECESSARY FOR THE USER TO REFER TO THE INSTRUCTION MANUAL"
"REFERREZ-VOUS AU MANUAL D'UTILISATION"
"UNBEDINGT IN DER BEDIENUNGSANLEITUNG NACHSCHLAGEN"



The Front Panel Controls and Their Use

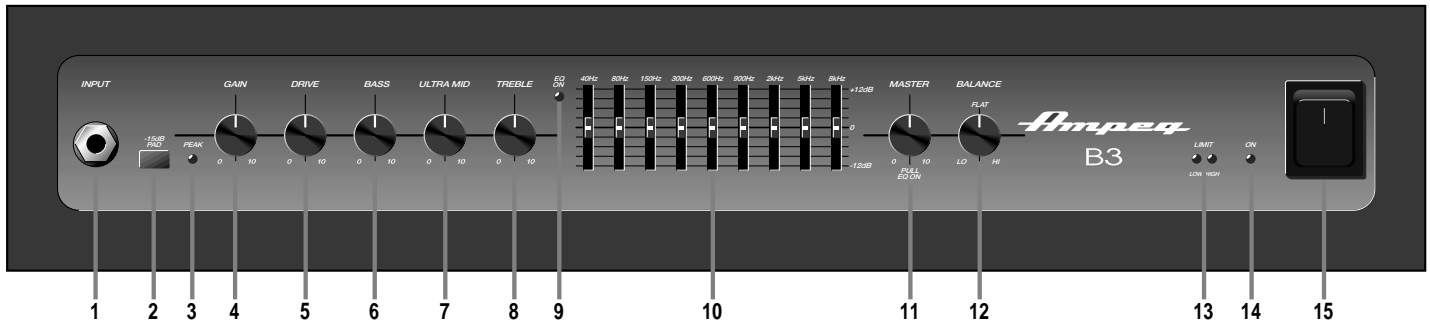

1. INPUT: The signal output from an instrument (active or passive) or a line level signal may be connected here by means of a shielded instrument cable.

2. -15dB PAD: This switch, when depressed, attenuates the input signal by 15dB. Attenuation allows the Gain control (#4) to be used in a more usable (higher) position. If clipping is indicated with the Gain control at a low setting, attenuation is needed.

3. PEAK LED: This LED flashes when the signal level into the preamp approaches clipping. Adjust the Gain control (#4) until a strong signal from your instrument causes this LED to flicker.

NOTE: If the LED flashes frequently with the Gain at a low setting, use the -15dB pad (#2) to attenuate the input signal and readjust the Gain.

4. GAIN: This serves as the input level control for the amplifier. For the best signal to noise ratio set this control so the Peak LED (#3) flashes when you strike a string fairly hard.

5. DRIVE: This control is used to overdrive the preamp in order to get various harmonic enhancement or distorted sounds. In the fully counterclockwise position the preamp is in the cleanest condition. As the control is rotat-

ed clockwise, signal level is increased to drive the preamp harder (into distortion). The tone of the signal is also changed to provide a smoother overdrive. (The tone controls may have to be readjusted to obtain the overall desired tone.) The Gain control (#4) and -15dB Pad (#2) interact with the Drive control. For greater overdrive, the Pad switch should be out and the Drive control fully clockwise. Use the Gain control to set the amount of overdrive desired. The Peak LED (#3) will illuminate steadily when the amp is used in this manner.

6. BASS: This is the primary low frequency control which allows for 12dB of cut or boost at 50Hz.

7. ULTRA MID: This is the primary midrange control. Rotate this control to the left of center for a "contoured" sound (more distant, less midrange output) or to the right of center for a pronounced (more up-front) tone.

8. TREBLE: This is the primary high frequency control which allows for 22dB of cut or 17dB of boost at 5kHz.

9. EQ ON LED: This LED illuminates when the EQ is turned on by either the Master Control (#11) or a footswitch (#24, rear panel).

10. GRAPHIC EQ: These sliders control the output frequencies indicated above each control. The center position of each control is flat (no boost or cut).

11. MASTER: Set the overall output level of the amplifier with this control. Pulling this knob out activates the Graphic EQ (#10). When a footswitch is connected (#24, rear panel) this switch is disabled.

12. BALANCE (B3158 only): This control proportions the output signal between the low and high frequency output jacks (see #18, rear panel) when using the amp in the biamp mode.

13. LIMIT LED(S): The LED illuminates whenever the amplifier is near full output, indicating that the internal limiter is keeping the output from distorting.

NOTE: There are two Limit LEDs only on the B3158: one for its low frequency power amp and one for its high frequency power amp.

14. POWER ON LED: This LED indicator illuminates when the POWER switch (#15) is ON.

15. POWER SWITCH: This heavy-duty rocker switch applies the power to the amplifier. The amp is ON when the top of the switch is depressed, OFF when the bottom of the switch is depressed.

1. ENTRADA: Conecte aquí su guitarra de bajos usando un cable blindado para instrumentos.

2. TERMINAL DE -15dB: Si su bajo tiene captadores de alta salida ó circuitos electrónicos activos, usted tal vez notará que el diodo (LED) de Picos (#3) parpadea ó permanece iluminado aún en posiciones bajas del control de Ganancia (#4). Conecte esta Terminal para conservar limpia la señal. Esto atenuará la señal de entrada hacia el preamplificador, lo que le permitirá obtener la mejor relación de señal-a-ruido para su bajo.

3. DIODO (LED) DE PICOS: Este LED se iluminará cuando cualquier etapa de preamplificación se encuentre cerca del punto de sobreimpulso. Ajuste el control de Ganancia (#4) hasta que una señal fuerte de su bajo cause un parpadeo de este LED.

NOTA: Si el LED permanece iluminado aún con la Ganancia en una posición baja, utilice la Terminal de -15dB (#2) para atenuar la señal de entrada y reajuste la Ganancia.

4. GANANCIA: Esto sirve como el control de nivel de entrada para el amplificador. Para lograr la mejor relación de señal-a-ruido fije este control para que el LED de Picos (#3) parpadee cuando usted pulse con fuerza alguna cuerda.

5. IMPULSO: Este control se usa para sobreimpulsar el preamplificador a fin de conseguir varios realces armónicos ó sonidos de distorsión. En la posición totalmente contraria a las manecillas del reloj, el preamplificador se encontrará en la posición más "limpia". Conforme el control se gire a favor de las manecillas del reloj, el nivel de la señal se incre-

mentará para impulsar el preamplificador con mayor fuerza (hacia la distorsión). El tono de la señal también cambia para proveer un sobreimpulso más suave. Tal vez tengan que ajustarse los controles de tono para obtener el tono general deseado. El control de Ganancia (#4) y la Terminal de -15dB (#2) interaccionan con el control de Impulso. Para un sobreimpulso mayor, el interruptor de la Terminal debe estar apagado y el control de Impulso totalmente a favor de las manecillas del reloj. Use el control de Ganancia para fijar la cantidad deseada de sobreimpulso. El diodo LED de Picos (#3) se iluminará en forma constante cuando el amplificador se utilice de esta manera.

6. BAJOS: Esta perilla sirve como el control primordial para las frecuencias bajas. Esto permite un rango de 8dB de recorte ó de refuerzo a 50Hz.



The Front Panel Controls and Their Use

7. ULTRA-MEDIANOS: Este es el control primordial para el rango de las frecuencias medianas. Gire el control del centro hacia la izquierda para lograr un sonido de contorno (más distante, menor salida en el rango mediano) ó del centro hacia la derecha para obtener un sonido realmente penetrante.

8. AGUDOS: Esta perilla sirve como el control primordial para las frecuencias altas. Esto permite un rango de 17dB de refuerzo ó 22dB de recorte a 5kHz.

9. EQ EN LED: Este diodo LED indicador se ilumina cuando usted activa el EQ mediante el control Maestro (#14) del panel delantero ó el interruptor de pie (#24) del panel posterior.

10. EQ GRAFICO: Estos controles deslizantes (cursores) le permiten ajustar la salida de las frecuencias que se muestran junto a cada control. La posición central de cada control es plana (sin

refuerzo ni recorte). Estos controles sólo afectan el sonido cuando el EQ esté prendido.

11. MAESTRO: Fije mediante este control el nivel general de salida del amplificador. El Circuito de Efectos y la Salida Equilibrada (#19, 20, 23) no se verán afectadas por el control Maestro. Jalando el control Maestro se prende el EQ Gráfico (#10). Cuando se utiliza el interruptor de pie, se pasa por alto el interruptor del panel delantero.

12. EQUILIBRIO (SOLO EN EL B358): Este control varía el nivel de la señal entre las salidas de bajas y altas frecuencias (véase el #18) para adecuar aún más el sonido).

13. DIODOS LED DE LIMITE: Este LED indicador parpadeará cada vez que se requiera el circuito limitador interno para conservar limpia la señal de salida del amplificador. Esto indica que el amplificador está aproximándose a su salida máxima y que el

limitador está impidiendo el aplanamiento ("clipping") de la señal de salida.

NOTA: Hay dos circuitos Limitadores dentro del B3158: uno para su amplificador de potencia de frecuencias bajas y otro para su amplificador de potencia de frecuencias altas. Todos los demás modelos tienen un solo circuito Limitador, y por lo tanto un solo LED de Limite.

14. DIODO LED DE POTENCIA ENCENDIDA: Este LED indicador se ilumina cuando se prende el interruptor de Potencia (#15).

15. INTERRUPTOR DE POTENCIA: Este interruptor de servicio pesado tipo vaivén aplica la energía de CA al amplificador: el amplificador se PRENDE en la posición hacia arriba ("I"), y se APAGA en la posición hacia abajo

The Rear Panel



16. FUSE: This protects the unit from damage due to overload conditions or power line surges. In case of failure, replace it only with the same size and type.

17. AC LINE IN: Firmly insert the supplied AC power cord into this socket until it is fully seated. Plug the male end of the cord into a grounded AC outlet. **DO NOT DEFEAT THE GROUND PRONG OF THE AC PLUG!**

18. SPEAKER OUTPUT(S): This section is different for each of the three models. The B3158 is shown in the illustration above.

The B3158 has two internal amplifiers, one for the high frequencies, one for the low. Each amplifier section has its own speaker output jack, factory-wired to the internal speakers. To use external speaker cabinets, unplug the connectors from the jacks and use speaker cables with 1/4" plugs to connect the LOW jack to your low frequency cabinet and the HIGH jack to the high frequency cabinet. Use the Balance control (#12, front panel) to proportion the

output signal between the low and high frequency output jacks. Observe the minimum impedance ratings for each output (8 ohms for high, 4 ohms for low).

The B3 has a single speaker output jack (wired at the factory to its speaker enclosure). To use an external speaker cabinet, disconnect the amplifier from the enclosure and connect it to the external cabinet, using a speaker cable with 1/4" plugs. Observe the 4 ohm minimum impedance rating.

The B328 has a single speaker output jack, and two input jacks on its speaker cabinet: WITH TWEETER and WITHOUT TWEETER. Connect the speaker cable to the jack which gives you the best sound. To use an external speaker cabinet, disconnect the amplifier from the enclosure and connect it to the external cabinet, using a speaker cable with 1/4" plugs. Observe the 4 ohm minimum impedance rating.

The following chart shows the total impedance load when connecting speaker cabinets in parallel:

Cabinet Impedance	# of Cabs	Total Impedance
8Ω	2	4Ω
16Ω	2	8Ω
16Ω	4	4Ω

19. EFFECTS RETURN: To use an external effects device or other signal processor, connect the OUTPUT of the device to this jack using a shielded cable. This returns the processed signal into the amplifier's master section.

20. EFFECTS SEND: Connect the output from this jack to the INPUT of an external effects device using a shielded cable. This sends a post-EQ signal to your effects. Since plugging a cable in here does not break the through connection to the power amp, this jack can also be used as an unbalanced line out jack.



The Rear Panel

21. PRE/POST SWITCH: You can select either pre or post-EQ for the signal at the Balanced Out jack (#23). With the switch in the OUT position, the signal at the jacks will be pre-EQ. This is a direct output which is not affected by any EQ or boost settings. With the switch depressed, the signal is post-EQ and is controlled and modified by the tone controls, Graphic EQ and Effects Loop.

22. -20dB SWITCH: This switch adjusts the

output level at the Balanced Out jack (#23). The switch works independently from the front panel Master control. Depressing the switch activates the -20dB pad, which allows patching into a mixer's mic input without overdriving it.

23. BALANCED OUT: This XLR-type connection supplies a balanced preamp output signal for connecting to a house mixing board, recording console or external amplifiers with balanced inputs. The signal can be

set to pre or post-EQ by the Pre/Post switch (#21). The level can be adjusted for either mic or line type inputs using the -20dB switch (#22).

24. FOOTSWITCH: This jack accepts the 1/4" plug from a 1-button footswitch, allowing remote control of the Graphic EQ on/off function. When a footswitch is used, the front panel Master Pull EQ On switch (#11) is bypassed.

16. FUSIBLE: Esto protege a la unidad contra daños debidos a condiciones de sobrecarga ó sobretensiones transitorias en la línea de energía. Si el fusible se quema, repóngalo sólo con el mismo tipo y tamaño.

17. ENTRADA DE LA LINEA DE CA: Conecte firmemente a este receptáculo el cable suministrado de corriente de CA, oprimiéndolo hasta que quede totalmente asentado. Enchufe el extremo macho del cordón a una salida aterrizada de CA. **¡NO PASE POR ALTO EL BORNE DE TIERRA DE LA CLAVIJA DE CA!**

18. SALIDA(S) DE LA(S) BOCINA(S): Esta sección es diferente para cada de los tres modelos. El B3158 aparece en la ilustración arriba.

El B3158 tiene dos amplificadores internos, uno para las frecuencias agudas, uno para las graves. Cada sección de amplificadores tiene su propio "jack" de salida para bocinas. Este modelo viene cableado desde la fábrica a su propio gabinete de bocinas: el conector negro "cola de cochino" va al "jack" BAJO, el gris al "jack" AGUDO. Para utilizar gabinetes de bocinas externos, desenchufe los conectores de los "jacks" y use cables para bocinas con clavijas de 1/4" para conectar el "jack" BAJO a su gabinete de frecuencias bajas y el "jack" de AGUDOS al gabinete de frecuencias altas. Observe la especificación de impedancias mínimas para cada "jack" (8 ohms para los agudos, 4 ohms para los bajos).

El B3 tiene un "jack" de salida para una sola bocina (que viene cableado desde la fábrica a su propio gabinete de bocinas). Para usar un gabinete externo de bocinas, desenchufe el amplificador del gabinete y con-

nectarlo a el gabinete externo. Use un cable para bocinas con clavijas de 1/4". Observe la especificación de 4 ohms de impedancia como mínimo.

El B328 tiene un "jack" de salida para bocinas, y dos "jacks" de entrada en el gabinete de los bocinas internal: "WITH TWEETER" (con la bocina de las agudos) y "WITH-OUT TWEETER" (sin la bocina de las agudos). Para usar un gabinete externo de bocinas, desenchufe el amplificador del gabinete y conectarlo a el gabinete externo. Use un cable para bocinas con clavijas de 1/4". Observe la especificación de 4 ohms de impedancia como mínimo.

La tabla a continuación muestra la carga de impedancia total cuando se conecten gabinetes de bocinas en paralelo:

Impedancia de cada Gabinete	# de Gabinetes	Impedancia Total
8 ohms	2	4 ohms
16 ohms	2	8 ohms
16 ohms	4	4 ohms

19. RETORNO DE EFECTOS: Para utilizar un dispositivo de efectos externo ú otro procesador de señales, conecte la SALIDA del dispositivo a este "jack" usando un cable blindado. Esto alimenta la señal procesada a la sección maestra del amplificador.

20. ENVIO DE EFECTOS: Conecte la salida de este "jack" a la ENTRADA de un dispositivo de efectos externo usando un cable blindado. Esto envía una señal post-EQ a sus efectos. Siendo que la conexión de un cable en este lugar no rompe la conexión directa al amplificador de potencia, esto se puede utilizar como otra línea hacia afuera.

21. INTERRUPTOR PRE/POST: Usted puede seleccionar por medio de este interruptor ya sea pre ó post-EQ para la señal en el "jack" de Salida Equilibrada (#23). Con el interruptor en la posición de FUERA, la señal en los "jacks" será pre-EQ. Esta es una salida directa no afectada por ningunas posiciones del EQ ó de refuerzo. Con el interruptor hacia adentro, la señal es post-EQ y se controla y modifica mediante los controles de tono, el EQ Gráfico y el Circuito de Efectos.

22. INTERRUPTOR DE -20dB: Este interruptor ajusta el nivel de salida en el "jack" de Salida Equilibrada (#23). El interruptor funciona independientemente del control Maestro del panel delantero. Al oprimirse el interruptor hacia adentro se activa la terminal de los -20dB, lo que permite conectarse a las entradas para micrófonos en un mezclador sin sobreimpulsarlos.

23. SALIDA EQUILIBRADA: Esta conexión tipo XLR proporciona una señal de salida equilibrada de preamplificación para conectarse a un tablero mezclador local, una consola grabadora ó amplificadores externos con entradas equilibradas. La señal se puede establecer como pre ó post-EQ mediante el interruptor Pre / Post (#21). El nivel se puede ajustar para entradas de tipos ya sean de micrófono ó de línea utilizando el interruptor de -20dB (#22).

24. INTERRUPTOR DE PIE: Este "jack" acepta la clavija de 1/4" de un interruptor de pie de un solo botón, lo que permite un control remoto de la función de prender / apagar del EQ Gráfico. Cuando se utiliza un interruptor de pie, se pasa por alto el interruptor Maestro para Prender ó Jalar el EQ (#11).



Some Suggested Settings*

ROCK:

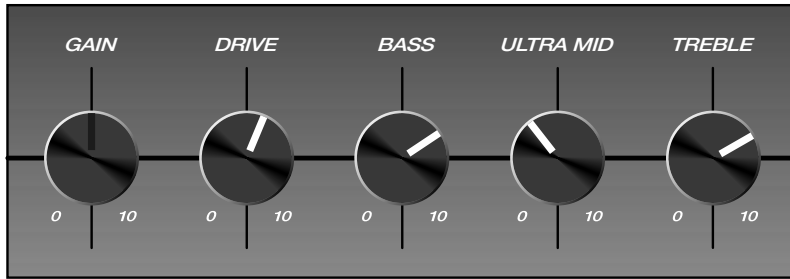

The setting of the Gain control depends on your particular instrument.

JAZZ:

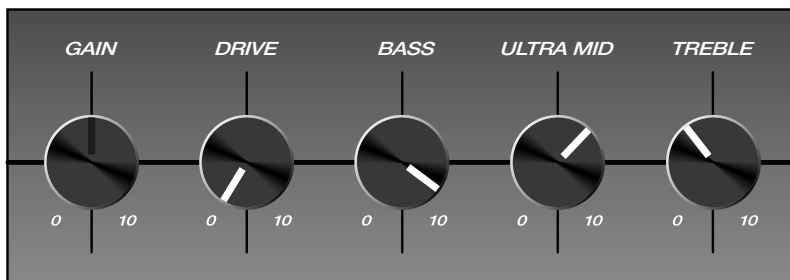

The Master control should be set to produce the appropriate output volume level.

COUNTRY:

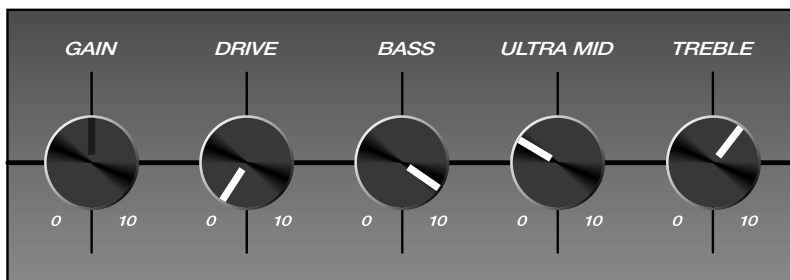

The Graphic EQ can be used to tailor the amplifier to your speaker cabinets, to compensate for room acoustics and to "fine tune" your sound.

FUNK "POPPING:"

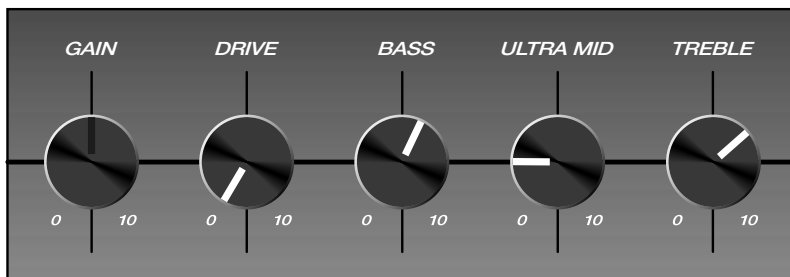

Troubleshooting

In the unlikely event that your B3/B328/B3158 should malfunction, take a few minutes to troubleshoot it before you call for service. You can save yourself time and money by doing it yourself, and often the cure for the problem is something quite simple.

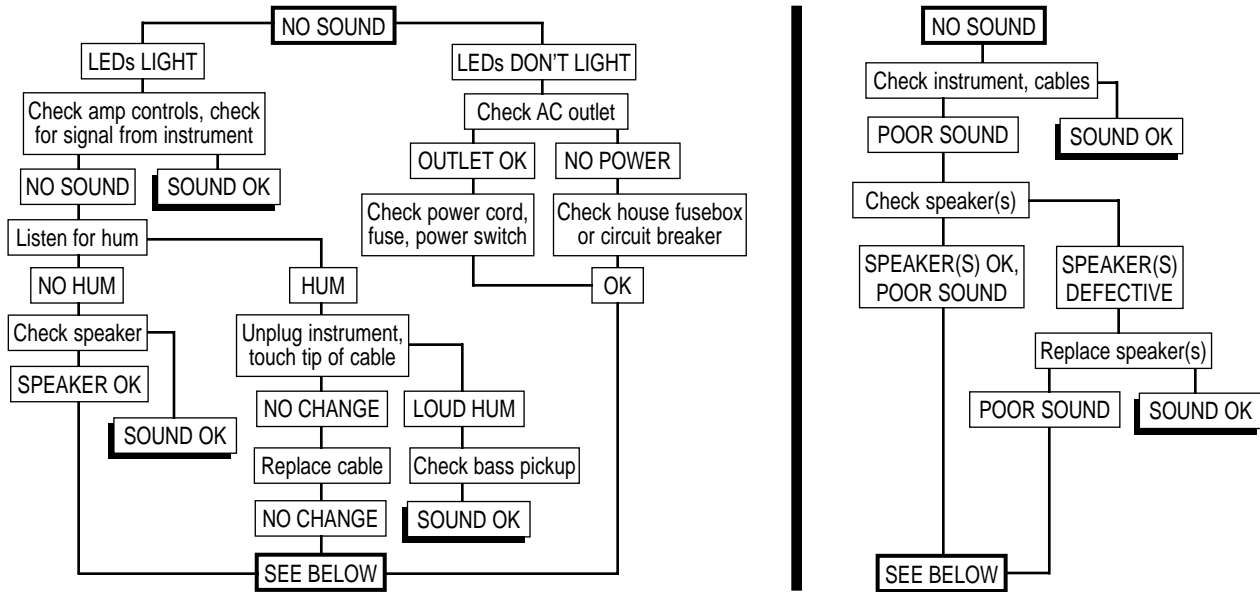

If the problem isn't covered above, or if the steps lead you here, then contact your Ampeg dealer for service information. Also, you should refer your amp for servicing if it gets dropped, has liquid spilled into it, or sustains damage to its power cord (see page 2).

System Block Diagram

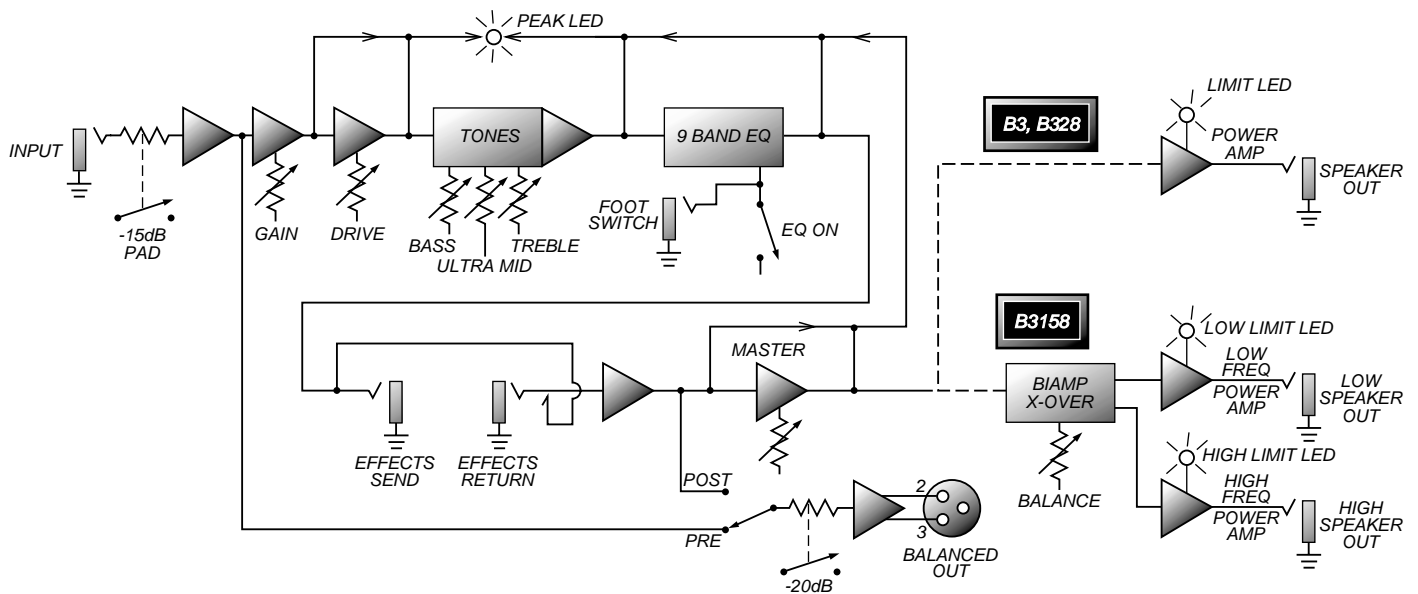



Technical Specifications

OUTPUT POWER RATING

B3, B328: 150 Watts RMS, 4Ω load
B3158: Low Freq - 100 Watts RMS, 4Ω load
High Freq - 50 Watts RMS, 8Ω load

POWER REQUIREMENTS

120VAC, 60Hz, 170VA
100/115VAC, 50/60Hz, 170VA
220-240VAC, 50/60Hz, 170VA

TONE CONTROL RANGE

Bass: ±8dB @ 50Hz
Ultra-Mid: +5, -17dB @ 500HZ
Treble: +17, -22dB @ 5KHZ

GRAPHIC EQ RANGE

±11dB @ 40Hz; ±8dB @ 80, 150, 300, 600, 900, 2kHz; ±9dB @ 9kHz

GAIN

66dB typical, tones @ center

SIGNAL TO NOISE RATIO

75dB typical

INTERNAL SPEAKERS

	B3	B328	B3158
Low Frequency:	Size/Type: 15" Ampeg Custom (1)	8" Polypropylene (2)	15" Ampeg Custom (1)
	Magnet: 56 oz	30 oz	56 oz
	Voice Coil: 2.5"	1.5"	2.5"
	Impedance: 4Ω	8Ω	4Ω
High Frequency:	Size/Type: N/A	Hi-Efficiency Piezo (1)	8" Polypropylene (1)
	Magnet:		30 oz
	Voice Coil:		1"
	Impedance:		8Ω
SIZE AND WEIGHT	B3	B328	B3158
(W x H x D)	20"x26"x13.5"	20"x18.75"x13.5"	20"x34.5"x14.5"
	68 lbs.	57 lbs.	84 lbs.



www.ampeg.com

Ampeg reserves the right to change specifications without notice.

