

DATA PROJECTOR XJ-S43W

User's Guide

- Be sure to read the precautions in the separate User's Guide (Basic Operation). For details about setting up the projector and lamp replacement, see the User's Guide (Basic Operation).
- Be sure to keep all user documentation handy for future reference.

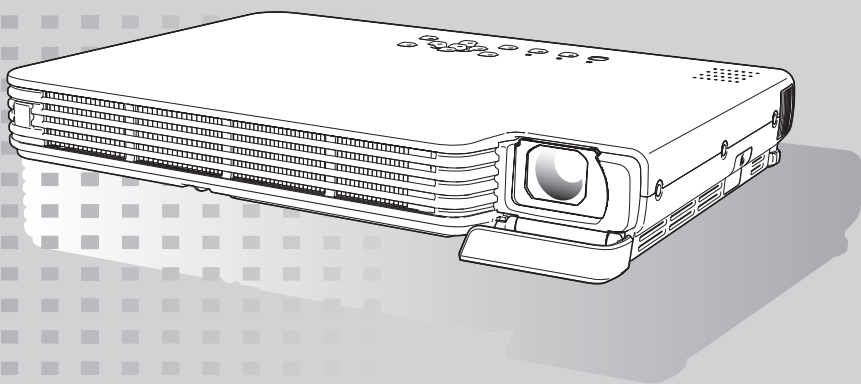

CASIO®

- DLP is a registered trademark of Texas Instruments of the United States.
- Microsoft, Windows, and Windows Vista are registered trademarks or trademarks of Microsoft Corporation in the United States and other countries.
- HDMI, the HDMI Logo and High-Definition Multimedia Interface are trademarks or registered trademarks of HDMI Licensing LLC.
- XGA is a registered trademark of IBM Corporation of the United States.
- Other company and product names may be registered product names or trademarks of their respective owners.

- The contents of this User's Guide are subject to change without notice.
- Copying of this manual, either in part or its entirety is forbidden. You are allowed to use this manual for your own personal use. Any other use is forbidden without the permission of CASIO COMPUTER CO., LTD.
- CASIO COMPUTER CO., LTD. shall not be held liable for any lost profits or claims from third parties arising out of the use of this product or this manual.
- CASIO COMPUTER CO., LTD. shall not be held liable for any loss or lost profits due to loss of data due to malfunction or maintenance of this product, or any other reason.
- The sample screens shown in this manual are for illustrative purposes only, and may not be exactly the same as the screens actually produced by the product.

Contents

About this manual.....	5
Projector Overview	6
Projector Features and Main Functions	6
Projector Keys and Remote Controller Keys.....	7
Operation During Projection	8
Image Operations During Projection	8
Adjusting Image Brightness	8
Selecting the Color Mode.....	9
Zooming an Image	9
Momentarily Cutting Off the Input Source Image	10
Freezing an Image	10
Displaying a Pointer in the Projected Image	11
Changing the Aspect Ratio of the Projected Image	12
Adjusting the Volume Level.....	13
To adjust the volume level	13
To mute the audio	13
Eco Mode	13
Using the [FUNC] Key.....	14
Configuring Advanced Projector Settings.....	15
Basic Setup Menu Operations	15
Displaying the Setup Menu	15
Configuring Setup Menu Settings	15
Basic Setup Menu Example	16
Direct Power On.....	18
Password Protecting the Projector.....	19
Inputting a Password	19
Using the Password Feature.....	19
Entering the Password when Turning On the Projector.....	21
Restoring Projector Settings to Their Initial Factory Defaults.....	22
Setup Menu Contents	23
Image Adjustment 1 Main Menu	24
Image Adjustment 2 Main Menu	25
Volume Adjustment Main Menu	26

Screen Settings Main Menu	27
Input Settings Main Menu	29
Option Settings 1 Main Menu.....	30
Option Settings 2 Main Menu.....	32
Operational Info Main Menu.....	33
Restore All Defaults Main Menu.....	34

User Maintenance 35

Cleaning the Projector.....	35
Cleaning the Projector Exterior	35
Cleaning the Lens	35
Cleaning Intake and Exhaust Vents.....	36
Replacing the Lamp	37
To check the current lamp use time.....	37
When to replace the lamp	37
Replacing the Lamp	38
To replace the lamp	39
Resetting the Lamp Time.....	40
To reset the lamp time	40
To reset the lamp time after exceeding the lamp life	41

Error Indicators and Warning Messages 42

Appendix 45

Connecting to a Component Video Output Device	45
Connecting the HDMI Output of a Video Device or Computer to the Projector	46
Remote Controller Signal Range	47
Replacing the Remote Controller Battery.....	48
Projection Distance and Screen Size	49
Aspect Ratio Setting and Projection Image.....	50
Supported Signals	52

About this manual...

- This manual assumes that you are already familiar with the contents of the separate “User’s Guide (Basic Operation)”.
- All of the operations in this manual are explained using the remote controller that comes with the projector. The following key operations can also be performed on the projector instead of the remote controller: [MENU], [▲], [▼], [▶], [◀], [ENTER], [ESC], [⏻], [INPUT], [AUTO], [ZOOM +], [ZOOM -], [FOCUS ▲], [FOCUS ▼].

To perform this remote controller operation:	Use this projector button:
[ENTER]	Button in the center of the cursor keys
[ZOOM +], [ZOOM -]	[ZOOM] button in combination with the [▶] and [◀] (or [▲] and [▼]) buttons
[FOCUS ▲], [FOCUS ▼]	[FOCUS] button in combination with the [▲] and [▼] (or [▶] and [◀]) buttons

Projector Overview

This section describes the features of the projector, and explains the functions of the projector and remote controller keys.

Projector Features and Main Functions

- **Slim and compact:**

B5 file size and a mere 32 mm slim (at thinnest part). Compact enough to install or use just about anywhere.

- **WXGA resolution:**

This is the first of the CASIO Super Slim projector series to support WXGA (1280 × 800) resolution for optimal viewing of content formatted for today's widescreen displays. This makes it perfect for projecting images from widescreen notebook PCs and HD video input sources.

- **HDMI video/audio input:**

HDMI (High Definition Multimedia Interface) input support enables direct connectivity with today's HDMI enabled notebook PCs, HD video devices, Blu-ray Disc players, games, and other devices for image projection and audio output.

- **Wide projection range, from a minimum of 0.84 meters:**

Wide angle 2X zoom allows projection even when projector-to-screen distance is severely limited. Minimum projection distance is 1.7 meters, even when projecting onto a 60-inch large screen.

- **A selection of possible input sources:**

Computer RGB, composite video, component video (Y-Cb/P-Cr/Pr), and HDMI audio/video are all supported as input sources.

- **Direct Power On:**

The projector can be configured to turn on automatically and start projecting as soon as it is plugged into a power outlet. This eliminates keeping your audience waiting as you perform time-consuming setups.

- **Pointer:**

The remote controller can be used to select one of a variety of different pointers for use during projection.

Projector Keys and Remote Controller Keys

Projector Keys and Indicator Panel

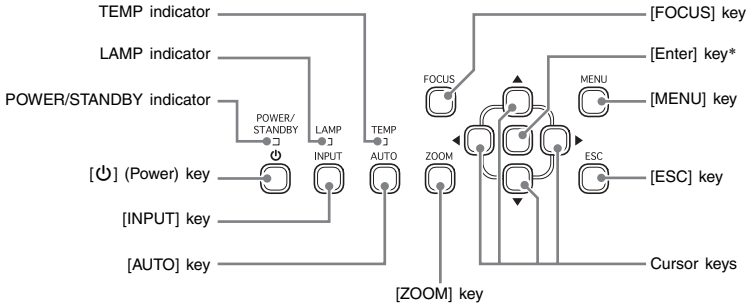

* The projector's enter key does not have anything printed on it. When you see [ENTER] in this manual, it means you should press the projector's enter key or the [ENTER] key of the remote controller.

Remote Controller Keys

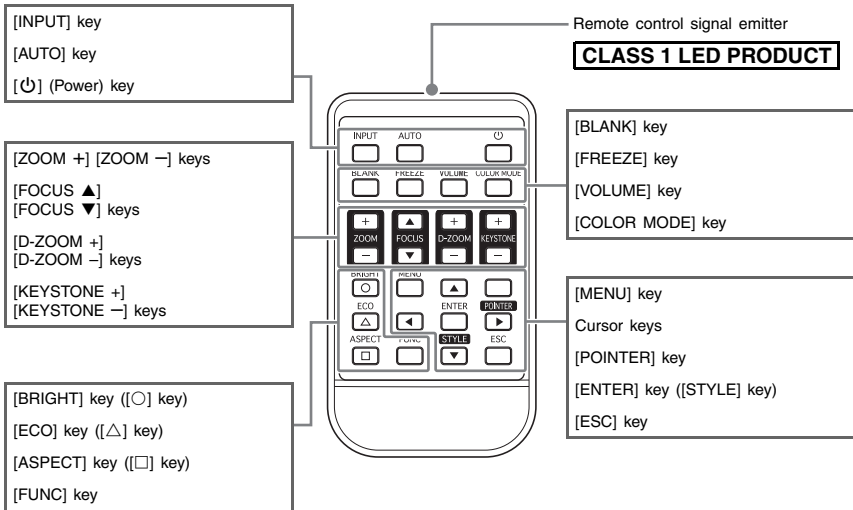

Important!

- To avoid running down the battery, store the remote control unit so its buttons are not pressed inadvertently.

Operation During Projection

This section explains the various types of operations you can perform while the projector is projecting an image.

Image Operations During Projection

You can perform the following operations while projecting an image.

- Image brightness adjustment
- Color mode selection
- Image zooming
- Momentary cut off of the input source image and projection of a black or blue screen, or a logo
- Image freeze
- Pointer display in the projected image
- Aspect ratio switching

Adjusting Image Brightness

To adjust image brightness

- 1 Press the [BRIGHT] key.**
 - This displays the brightness adjustment window.



- 2 Use the [◀] and [▶] keys to adjust image brightness.**
- 3 To hide the window, press the [ESC] key.**

Selecting the Color Mode

You can select from among five different color mode settings to optimize the projected image in accordance with image contents and projection conditions.

To change the color mode

1 Press the [COLOR MODE] key.

- This displays the color mode selection window. The currently selected color mode is the one whose button is selected (filled in).

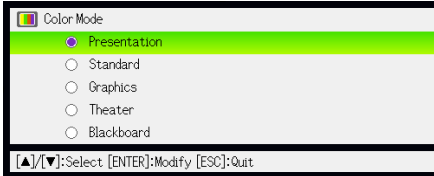

2 Use the [▼] and [▲] keys to move the highlighting to the color mode you want to select, and then press the [ENTER] key.

- This will select the button next to the highlighted color mode name.
- For details on what each color mode does, see “Color Mode” under “Image Adjustment 1 Main Menu” on page 24.

3 To hide the window, press the [ESC] key.

Zooming an Image

1 Press the [D-ZOOM +] key.

- This will enlarge the center of the projected image one step.

2 To zoom in on the center of the projected image more, press the [D-ZOOM +] key again. To zoom out, press the [D-ZOOM -] key.

- Each press of [D-ZOOM +] zooms in (increases the zoom factor), while [D-ZOOM -] zooms out. Holding down either key continuously scrolls the zoom factor.

3 While an image is zoomed, use [▲], [▼], [◀], and [▶] to scroll the view to other parts of the image.

4 To exit the zoom operation, press the [ESC] key.

Momentarily Cutting Off the Input Source Image

- 1 Press the [BLANK] key.**
 - This temporarily cuts off the image from the input source and projects a black screen in its place.
- 2 To resume projection of the image from the input source, press the [BLANK] key (or [ESC] key).**



Note

You can specify projection of a black screen or blue screen, or a logo. For details, see “Blank Screen” under “Screen Settings Main Menu” on page 28.

Freezing an Image

Pressing the [FREEZE] key freezes the projected image.

To freeze the projected image

- 1 While an image is being projected from an input source, press the [FREEZE] key.**
 - This will capture the image that is on the screen at the moment you press [FREEZE] and stores it in projector memory. That image remains projected on the screen.
- 2 To restore projection of the image from an input source, press the [ESC] key.**

Displaying a Pointer in the Projected Image

You can select from among different pointer styles, including various arrow styles, for display in the projected image. Pointers can be used during a presentation to indicate or highlight a specific part of the image.



Note

Depending on the pointer style you are using, the pointer may not display properly when you are using keystone correction. If this happens, use the [KEystone +] and [KEystone -] keys to change the keystone correction value to zero.

To display a pointer in the image

1 Press the [POINTER] key.

- This will cause a pointer to appear in the image.
- You also can use the setup menu to specify the pointer type that appears first when you press the [POINTER] key. For details, see “Pointer” under “Option Settings 2 Main Menu” on page 32.

2 Use the cursor keys to move the pointer to the location you want.

- Holding down a cursor key moves the cursor at high speed.

3 To modify the pointer as described below, press the [STYLE] key.

For this pointer type:	Pressing [STYLE] will change it like this:
	→ → →
	→ → → →
	→ → →
	→ → →
	Toggle between flashing and not flashing

To select the pointer type

1 Press the [POINTER] key to display the pointer.

2 Keep pressing the [POINTER] key until the pointer you want is displayed.

- Each press of the [POINTER] key cycles through the available pointer types.

To clear the pointer from the image

Press the [ESC] key.

Changing the Aspect Ratio of the Projected Image

Use the [ASPECT] key to change the aspect ratio of the projected image.

When the input source is this:	Each press of [ASPECT] cycles through these settings:
VIDEO, component, or HDMI (DTV)	Normal → 16:9 → Letter Box When the input source is either a component signal or an HDMI (DTV) signal with an aspect ratio of 16:9, the projection aspect ratio also will become 16:9 automatically. Pressing the [ASPECT] key will not change it.
RGB or HDMI (PC)	Normal → Full → True

For details about the meanings of the “Normal”, “16:9”, “Letter Box”, “Full”, and “True” settings, see “Aspect Ratio” under “Screen Settings Main Menu” (page 27).



Note

- For details about how the aspect ratio setting affects the projected image, see “Aspect Ratio Setting and Projection Image” (page 50).
- You also can change the aspect ratio setting using the setup menu. For details, see “Aspect Ratio” under “Screen Settings Main Menu” on page 27.



Important!

Note that enlarging or reducing the size of an image using the [ASPECT] key for commercial purposes or public presentation may infringe on the legally protected copyright of the copyright holder of the original material.

Adjusting the Volume Level

You can use the remote controller keys to adjust the volume level of the audio that is output from the projector's speaker.

To adjust the volume level

- 1 On the remote controller, press the [VOLUME] key.
 - This causes the [Volume] screen to appear on the projected image.

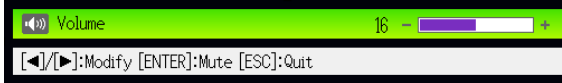

- 2 Press the [▶] key to increase the volume, or the [◀] key to lower the volume.
- 3 After the setting is the way you want, press the [ESC] key.
 - This causes the [Volume] screen to disappear.



Note

- You also can use the setup menu to adjust the volume level. For details, see “Volume Adjustment Main Menu” on page 26.
- Pressing the [VOLUME] key will not display the [Volume] screen if no audio is being input to the HDMI port during projection of an HDMI signal.

To mute the audio

- 1 On the remote controller, press the [VOLUME] key.
- 2 Press the [ENTER] key.
 - This stops output from the speaker.
- 3 To restore the audio, press the [VOLUME] key again.

Eco Mode

Turning on the Eco Mode reduces lamp brightness to save power. The projector's cooling fan also operates at a slower speed while the Eco Mode is turned on, which results in quieter operation.

Turn on the Eco Mode when your priority is quieter operation. Turn off the Eco Mode when your priority is maximum brightness.

To turn the Eco Mode on or off

Press [ECO] to toggle the Eco Mode on and off.

Using the [FUNC] Key

Pressing the [FUNC] key displays the menu shown below.

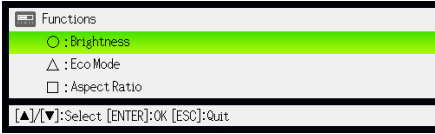

You can use this menu to perform the operations described below.

- **Adjust image brightness**

Highlight “Brightness” and then press the [ENTER] key.

- This performs the same operation as pressing the [BRIGHT] key (○ key) described on page 8.

- **Turn the Eco Mode on or off**

Highlight “Eco Mode” and then press the [ENTER] key.

- This performs the same operation as pressing the [ECO] key (△ key) described on page 13.

- **Select the aspect ratio of the projected image**

Highlight “Aspect Ratio” and then press the [ENTER] key.

- This performs the same operation as pressing the [ASPECT] key (□ key) described on page 12.

Configuring Advanced Projector Settings

Your projector has a setup menu that you can use to configure advanced settings.

Basic Setup Menu Operations

Displaying the Setup Menu

Pressing the [MENU] key displays the menu shown below in the center of the projection screen.

Main menu
The main menu includes nine main menu items. The currently selected main menu item is the one that is highlighted.

Sub-menu
The sub-menu shows each individual setting under each main menu item, and its current setting.

Guidance text
Guidance text provides a brief description of the main key operations available for the operation you are currently performing.

To exit the setup menu

Press the [MENU] key.

Configuring Setup Menu Settings

- 1 Press the [MENU] key to display the setup menu.
- 2 Use the [▼] and [▲] keys to select the main menu item you want by highlighting it.
- 3 Press the [ENTER] key.
- 4 Use the [▼] and [▲] keys to select the sub-menu item you want by highlighting it.
- 5 Perform the required operation on the selected sub-menu item screen.
 - The guidance text explains the operations you need to perform to configure each setting.
- 6 To return to the main menu from the sub-menu, press the [ESC] key.
- 7 To exit the setup menu, press the [MENU] key.

Basic Setup Menu Example

The procedure below shows how to configure the following three settings:

- Image Adjustment 1 → Contrast
- Image Adjustment 1 → Color Mode
- Option Settings 1 → Eco Mode



Note

- Certain settings on the setup menu cannot be changed while there is no input signal to the projector. Because of this, you should configure setup menu settings after selecting an input source and starting projection.
- This example covers basic steps only. For more detailed information, see “Setup Menu Contents” on page 23.

To configure the “Image Adjustment 1 → Contrast” setting

- 1 Press the [MENU] key to display the setup menu.
- 2 “Image Adjustment 1” is initially selected on the main menu, so simply press the [ENTER] key.
- 3 Press the [▼] key once to select “Contrast”.

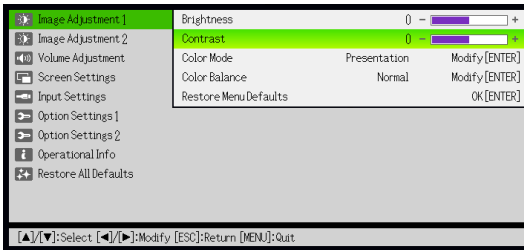

- 4 Use the [◀] (lighter) and [▶] (darker) keys to adjust contrast.

To configure the “Image Adjustment 1 → Color Mode” setting

5 Press the [▼] key once to select “Color Mode”.

6 Press the [ENTER] key.

- This displays the color mode menu.

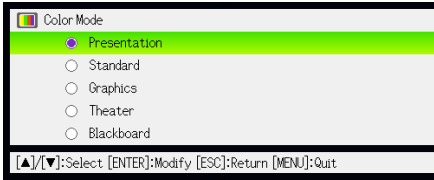

7 Use the [▼] and [▲] keys to select the color mode you want, and then press the [ENTER] key.

8 After selecting the color mode you want, press the [ESC] key.

To configure the “Option Settings 1 → Eco Mode” setting

9 Press the [ESC] key.

10 Press the [▼] key five times to select “Option Settings 1”.

11 Press the [ENTER] key.

12 Press the [▼] key two times to select “Eco Mode”.

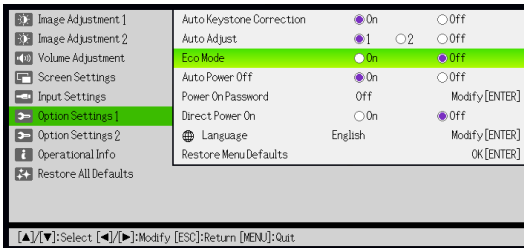

13 Use the [◀] and [▶] keys to select “On” or “Off”.

14 After you are finished, press the [MENU] key to exit the setup menu.

Direct Power On

You can configure the projector so it powers up automatically as soon as you plug it into a power source. With this “Direct Power On” feature, you do not even need to press the [⏻] (power) key. To enable Direct Power On, display the Setup Menu, and then change the “Direct Power On” setting to “On”.



Important!

- When you have Direct Power On enabled, do not leave the projector plugged into an electrical outlet while it is turned off. If you do, there is the chance that it (and the lamp) might turn on automatically when power is restored after being cut off by a power outage, tripping of a breaker, etc.



Note

- Direct Power On causes the projector to turn on automatically as soon as it is plugged into a power outlet. This greatly reduces the amount of time it takes until you are ready to start projecting. Note, however, that the actual startup sequence (Standby State → Power On → Warm Up → Projection Starts) that the projector performs is the same, regardless of whether Direct Power On is enabled or disabled. The only difference is what triggers the sequence (plugging in or pressing the [⏻] (power) key). For details about the startup sequence that the projector performs when you plug it into a power source, see “To turn on the projector” in the separate “User’s Guide (Basic Operations)”.
- For details about configuring the Direct Power On setting, see “Direct Power On” under “Option Settings 1 Main Menu” on page 30.

Password Protecting the Projector

The password feature lets you keep unauthorized individuals from using the projector. You can specify whether password input is required whenever you turn on the projector, and you can specify and change the password as required. Use the setup menu “Option Settings 1 → Power On Password” setting to configure power on password settings.

Inputting a Password

The password of your projector is not really a “word” made up of letters, but rather a sequence of remote controller key inputs. The following is the 8-key sequence that represents the initial factory default password.

[INPUT][AUTO][BLANK][FREEZE][▲][▼][◀][▶]
--

Using the Password Feature

Note the following precautions whenever you use the password feature.

- The password feature protects against unauthorized use of the projector. Note that it is not an anti-theft measure.
- You will need to enter the initial factory default password the first time you use the projector after turning on the password feature. Change the initial factory default password to a different one of your choice as soon as possible after turning on the password feature.
- Remember that password operations are always performed using the remote controller, so you should take care not to lose or misplace the remote controller.
- Also note that you will not be able to input the password if the remote controller battery is dead. Replace the remote control battery as soon as possible after it starts to go low.

If you forget your password...

You will not be able to use the projector if you forget the password for some reason. If you forget the password, you will need to bring the following two items to your CASIO distributor to have the password cleared. Note that you will be charged to have the password cleared.

1. Personal identification (original or copy of you driver’s license, employee I.D., etc.)
2. Projector unit

Note that your CASIO distributor will not be able to clear the password of your projector unless you bring both of the items listed above.

Also, keep the projector’s warranty in a safe place.



Important!

Having your password cleared using the procedure described above will return all of the settings of your projector, except for the lamp time, to their initial factory defaults.

Keep a written record of your password!

You will not be able to use the projector if you forget its password. We strongly suggest that you keep a written or other type of record of the password so you can look it up when necessary.

To change the password

- 1 Press the [MENU] key to display the setup menu.
- 2 Use the [▼] key to select “Option Settings 1”, and then press the [ENTER] key.
- 3 Use the [▼] key to select “Power On Password”, and then press the [ENTER] key.
 - This will display a dialog box prompting you to enter the current password.

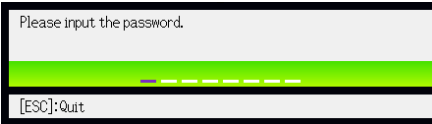

- 4 Enter the current password.
 - If the projector is still protected by the factory default password, perform the key operation shown below to enter it.



- 5 After entering the current password, press the [ENTER] key.
 - This displays the Power On Password setting screen.
- 6 Use the [▼] key to select “Change Password”, and then press the [ENTER] key.
 - This will display a dialog box prompting you to enter the new password.
- 7 Enter a key sequence up to eight key operations long.
 - You can use any of the following keys as part of your password key sequence. [INPUT], [AUTO], [BLANK], [FREEZE], [VOLUME], [COLOR MODE], [D-ZOOM +], [D-ZOOM -], [KEYSTONE +], [KEYSTONE -], [MENU], [POINTER], [○], [△], [□], [▲], [▼], [◀], [▶], [FUNC]
- 8 After entering the new password, press the [ENTER] key.
 - This will display a dialog box prompting you to enter the same password again.
- 9 Re-enter the same password key sequence you entered in step 7 and then press [ENTER].
 - The message “Your new password has been registered.” indicates that the password has been changed. Press the [ESC] key.
 - If the password you entered in this step is different from the one you entered in step 7, the message “The password you input is wrong.” appears. Press the [ESC] key to return to step 7.

To turn password protection on and off

- 1 Display the Power On Password setting screen by performing steps 1 through 5 of the procedure under “To change the password” on page 20.
 - At this time, make sure that “Power On Password” is selected on the Power On Password setting screen.
- 2 Use the [◀] and [▶] keys to select “On” or “Off”.
 - Changing the power on password setting from “Off” to “On” causes the confirmation dialog box shown below to appear.

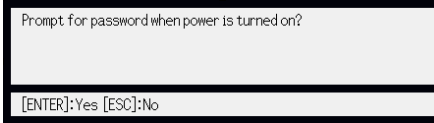

Prompt for password when power is turned on?

[ENTER]:Yes [ESC]:No

Press the [ENTER] key to confirm that you want to turn on power on password protection, or [ESC] to exit the dialog box without doing anything.

- 3 After you are finished, press the [MENU] key to exit the setup menu.

Entering the Password when Turning On the Projector

Turning on the projector while password protection is enabled will cause a password input dialog box to appear on the projection screen. All projector operations will be accessible to you after you input the correct password and press the [ENTER] key.



Note

You can perform the projection size adjustment operation ([ZOOM +] / [ZOOM -] keys), focus operation ([FOCUS ▲] / [FOCUS ▼] keys), and power off operation ([⏻] key) while the password input dialog box is on the projection screen.

Restoring Projector Settings to Their Initial Factory Defaults

You can use the procedures in this section to restore all of the settings on a particular main menu or all of the settings on the setup menu to their initial factory defaults.

To restore all settings on a particular main menu to their initial factory defaults

- 1 Press the [MENU] key to display the setup menu.
- 2 Use the [▼] and [▲] keys to select the main menu whose settings you want to restore to their initial factory defaults.
 - You can select Image Adjustment 1, Image Adjustment 2, Volume Adjustment, Screen Settings, Input Settings, Option Settings 1, or Option Settings 2.
- 3 Press the [ENTER] key.
- 4 Use the [▼] key to select “Restore Menu Defaults”.
- 5 Press the [ENTER] key.
 - This will display a confirmation screen like the screen shown below.

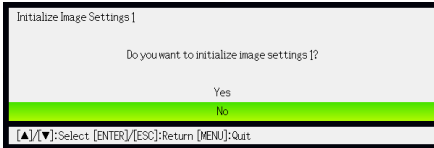

- 6 Use the [▲] key to select “Yes”.
- 7 To restore the settings of the main menu to their initial defaults, press the [ENTER] key.
 - To exit the operation without doing anything, press [ESC] instead of [ENTER].
- 8 After you are finished, press the [MENU] key to exit the setup menu.



Note

- The language setting and the password are not returned to their initial factory defaults if you select Option Settings 1 in step 2.
- For details about how the above procedure initializes settings, see the explanations of the settings under “Setup Menu Contents” on page 23.

To restore all settings on the setup menu to their initial factory defaults

- 1 Press the [MENU] key to display the setup menu.
- 2 Use the [▼] key to select “Restore All Defaults”, and then press the [ENTER] key.
- 3 Use the [▼] key to select “Restore All Defaults” sub-menu, and then press the [ENTER] key.
 - This displays a confirmation message asking if you want to initialize all settings.
- 4 Use the [▲] key to select “Yes”.
- 5 To restore all settings on the setup menu to their initial defaults, press the [ENTER] key.
 - This will restore all of the settings to their initial factory defaults, except for the Language, Lamp Time, and password settings.
 - To exit the operation without doing anything, press [ESC] instead of [ENTER].
- 6 After you are finished, press the [MENU] key to exit the setup menu.

Setup Menu Contents

This section contains tables that provide detailed explanations of all of the items included on the setup menu. The following describes the type of information that appears in each of the columns of the tables.

Setting Name

This column shows the names of the settings as they appear on the sub-menu.

Input

This column shows the input source for which each setting is supported.

Input source names are abbreviated as R (RGB input), C (component video input), V (video input), H (HDMI (PC) input), and D (HDMI (DTV) input). The letter N indicates that the setting can be configured while there is no input signal.

Setting Unit

The setting unit indicates how a setting is stored.

“Source Specific” in this column indicates that separate settings can be stored for each individual input source. For example, you could store an “Image Adjustment 1 → Brightness” setting of -1 for RGB input and a setting of +1 for VIDEO input.

“Single” in this column indicates that a single setting is stored and applied, regardless of the input source.

Description

This column provides details about the setting item and how to select it. The initial default setting is indicated by an asterisk (*).

Image Adjustment 1 Main Menu

Setting Name	Input	Setting Unit	Description
Brightness	RCVHD	Source Specific	Use this sub-menu to adjust the brightness of the projected image. A larger value produces a brighter image.
Contrast	RCVHD	Source Specific	Use this sub-menu to adjust the contrast of the projected image. A larger value produces a stronger contrast.
Sharpness	V	Source Specific	Use this sub-menu to adjust the sharpness of the outlines in the projected image. A larger value makes the image sharper, while a smaller value makes it softer.
Saturation	V	Source Specific	Use this sub-menu to adjust the color saturation of the projected image. A larger value increases color saturation.
Tint	V	Source Specific	Use this sub-menu to adjust the tint of the projected image. A larger value makes the overall image more bluish, while a smaller value makes the overall image more reddish. This setting is supported only when the signal is NTSC or NTSC4.43.
Color Mode	RCVHD	Source Specific	<p>You can select from among five different color mode settings to optimize the projected image in accordance with image contents and projection conditions.</p> <p>Presentation: Use this setting for standard presentations in a well-lit area.</p> <p>Standard: Use this setting when you want to highlight the colors of your presentation.</p> <p>Graphics: Use this setting when you want photographs and graphics to appear natural.</p> <p>Theater: Use this setting to bring out the dark portions of your images.</p> <p>Blackboard: Use this setting for easy viewing when projecting onto a blackboard.</p>
Color Balance	RCVHD	Source Specific	<p>This sub-menu lets you adjust the color balance of the projected image.</p> <p>Preset: You can select from among three preset color balance settings: Warm, Normal,* Cold.</p> <p>Color: You can adjust the intensity of red, green, and blue within the range of -50 to +50. The intensity of a color increases along with the setting value. Color settings can be adjusted individually only when "Normal" is selected as the "Preset" setting.</p>

Setting Name	Input	Setting Unit	Description
Noise Filter	V	Source Specific	This setting is valid when VIDEO is selected as the input source. Normal*: Select this setting when projecting a movie. High: Select this setting when projecting still images. In particular, this setting should be used when projecting still images from a digital camera connected to the projector's VIDEO terminal.
Restore Menu Defaults	RCVHD	Source Specific	Use this sub-menu to return all of the sub-menu items on the Image Adjustment 1 main menu to their initial default settings. ● Restoring menu defaults will restore defaults for the currently selected input source.

Image Adjustment 2 Main Menu

Setting Name	Input	Setting Unit	Description
Vertical Position	RCV	Signal Specific	Use this sub-menu to adjust the vertical position of the input source image within the projection area.
Horizontal Position	RCV	Signal Specific	Use this sub-menu to adjust the horizontal position of the input source image within the projection area.
Frequency	R	Signal Specific	When vertical bands appear in the projected image while RGB is selected as the input source, it means that the frequency setting is not correct. When this happens, use this setting to adjust the frequency manually.  Important! _____ If, for some reason, your manual frequency settings cause the image input from the computer to disappear from the projection, you can press the [AUTO] key to perform an auto adjust operation, which should cause the image to appear.
Phase	R	Signal Specific	When there is flickering in the projected image while RGB is selected as the input source, it means that the phase setting is not correct. When this happens, use this setting to adjust the phase manually.
Restore Menu Defaults	RCV	Source Specific	Use this sub-menu to return all of the sub-menu items on the Image Adjustment 2 main menu to their initial default settings. ● Restoring menu defaults will restore defaults for the currently selected input source. ● "Image Adjustment 2" main menu "Vertical Position", "Horizontal Position", "Frequency", and "Phase" defaults can be restored for the current signal type (XGA/60Hz, SXGA/60Hz, etc.) only.

About the “Signal Specific” Setting Unit

For the items that have “Signal Specific” in the “Setting Unit” column of the above table, the setting is saved for the specific type of signal (XGA/60Hz, SXGA/60Hz, etc.) that is being input when the setting is performed, and not for a specific input source.

Volume Adjustment Main Menu





Note

The following menu operations are not supported if no audio is being input to the HDMI port during projection of an HDMI signal.

Setting Name	Input	Setting Unit	Description
Volume	RCVHDN	Source Specific	Use this sub-menu to adjust the volume level of the projector's speaker. <ul style="list-style-type: none">● Changing this setting when there is no input signal changes the volume setting of the currently selected signal source.
Restore Menu Defaults	RCVHDN	Source Specific	Use this sub-menu to return Volume to its initial default setting. <ul style="list-style-type: none">● This menu item can be executed even when there is no input signal. Restoring menu defaults when there is no input signal will restore defaults for the currently selected input source.

Screen Settings Main Menu

Setting Name	Input	Setting Unit	Description
Keystone Correction	RCVHDN	Single	Use this sub-menu to correct vertical keystone of the projected image.
Aspect Ratio	RCVHD	Source Specific	<p>Use this sub-menu to select an aspect ratio setting for the projected image.</p> <p>Normal*: Projects at the projector's maximum possible size while maintaining the input signal aspect ratio.</p> <p>Full (RGB or HDMI (PC) input source only): Projects at the projector's maximum possible size by enlarging or reducing the input signal.</p> <p>True (RGB or HDMI (PC) input source only): Projects the input signal at its actual size (1 input source dot equal to one projector output pixel dot) in the center of the projector's projection screen. If the input signal resolution exceeds the projector's output resolution, the excess is cut off.</p> <p>16:9 (VIDEO, component or HDMI (DTV) input source only): Projects with an aspect ratio of 16:9 (movie, Hi-Vision, etc.) Selecting this option when projecting a video movie from an input source that has been squeezed from 16:9 to 4:3 will project the image with a normal aspect ratio.</p> <p>Letter Box (VIDEO, component or HDMI (DTV) input source only): Select this option when the input source is letter box. This will resize the image horizontally to 1280 dots and project 800 vertical dots of the center of the image, maintaining the aspect ratio of the input signal.</p> <p> Note _____</p> <ul style="list-style-type: none"> ● When the input source is a component signal with an aspect ratio of 16:9, the aspect ratio is fixed at 16:9 and the setting cannot be changed. ● For details about how the aspect ratio setting affects the projected image, see "Aspect Ratio Setting and Projection Image" (page 50). <p> Important! _____</p> <p>Note that enlarging or reducing the size of an image for commercial purposes or public presentation may infringe on the legally protected copyright of the copyright holder of the original material.</p>
Projection Mode	RCVHDN	Single	<p>Use this sub-menu to specify whether projection will be from the front of the screen or the back of the screen.</p> <p>Front*: Select this option to project from the front of the screen.</p> <p>Rear: Select this option to project from the back of the screen. This setting flips the front projected image horizontally.</p>

Setting Name	Input	Setting Unit	Description
Ceiling Mount	RCVHDN	Single	Use this sub-menu to configure the projector for use in an installation in which it is positioned upside down. On: Flips the projected image horizontally and vertically. Off*: Projects a normal image.
Startup Screen	RCVHDN	Single	Use this sub-menu to specify whether or not a startup screen should be projected whenever the projector is turned on. Logo: Select this option to project the projector's built-in logo screen at startup. None*: Select this option when you do not want to project a startup screen.
No Signal Screen	RCVHDN	Single	Use this sub-menu to specify what should be projected when there is no input signal to the projector. Blue*: Select this option to project a blue screen. Black: Select this option to project a black screen. Logo: Select this option to project the projector's built-in logo screen.
Blank Screen	RCVHDN	Single	Use this sub-menu to specify what should be projected after the [BLANK] key is pressed. Blue: Select this option to project a blue screen. Black*: Select this option to project a black screen. Logo: Select this option to project the projector's built-in logo screen.
Restore Menu Defaults	RCVHDN	Source Specific	Use this sub-menu to return all of the sub-menu items on the Screen Settings main menu to their initial default settings. <ul style="list-style-type: none"> ● Restoring menu defaults will restore defaults for the currently selected input source. ● Note that the "Keystone Correction", "Projection Mode", "Startup Screen", "No Signal Screen", and "Blank Screen" settings are always returned to their initial defaults, regardless of the currently selected input source.

Input Settings Main Menu

Setting Name	Input	Setting Unit	Description
COMPUTER Terminal	RC N	Single	<p>Use this sub-menu to specify manually the type of signal being input from the projector's COMPUTER terminal.</p> <p>Auto*: Automatically detects the signal being input from the COMPUTER terminal and configures the appropriate input protocol.</p> <p>RGB: Select this option when a computer is connected to the COMPUTER terminal. For details about connecting a computer, see "Connecting a Computer to the Projector" in the "User's Guide (Basic Operation)".</p> <p>Component: Select this setting when the projector's COMPUTER terminal is connected to the component video output terminal of a video device using an optionally available YK-3 component video cable. For information about connection, see "Connecting to a Component Video Output Device" on page 45.</p>
Video Signal	V N	Single	<p>Use this sub-menu to specify manually the type of signal being input from the projector's AV terminal.</p> <p>Auto*: Select this setting to have the projector switch the video signal system automatically in accordance with the input signal from the video device that is connected to the AV terminal.</p> <p>NTSC / NTSC4.43 / PAL / PAL-M / PAL-N / PAL60 / SECAM: Each setting selects the applicable video system. Use these settings when you want to specify only one specific video signal for the AV terminal.</p>
Signal Name Indicator	RCVHDN	Single	<p>Use this sub-menu to specify whether or not the name of the currently selected signal source should be displayed in the projected image.</p> <p>On*: Select this option to turn on display of the name of the currently selected signal source in the projected image.</p> <p>Off: Select this option to turn off display of the signal source name.</p>
Restore Menu Defaults	RCVHDN	Source Specific	<p>Use this sub-menu to return all of the sub-menu items on the Input Settings main menu to their initial default settings.</p> <ul style="list-style-type: none"> Restoring menu defaults will restore defaults for the currently selected input source. Note that the "Signal Name Indicator" setting is always returned to its initial default, regardless of the currently selected input source. Restoring menu defaults when there is no input signal will restore defaults for the currently selected input source.

Option Settings 1 Main Menu

Setting Name	Input	Setting Unit	Description
Auto Keystone Correction	RCVHDN	Single	Use this sub-menu to turn auto keystone correction on or off. On*: Select this option to turn on auto keystone correction. Off: Select this option to turn off auto keystone correction.
Auto Adjust	R N	Single	Use this sub-menu to select whether the projector should detect the RGB input signal type (resolution, frequency) and adjust the projection image accordingly (auto adjust). 1*: Select this option to turn on auto adjust. 2: Select this option to turn on auto adjust when a 1360 × 768 or 1400 × 1050 signal is not projected correctly. Off: Select this option to turn off auto adjust.
Eco Mode	RCVHDN	Single	Use this sub-menu to turn the Eco Mode on or off. On: Select this option to reduce lamp brightness and save power. This setting also reduces the speed of the projector's cooling fan, which reduces operation noise. Off: Select this option to project at maximum brightness.
Auto Power Off	RCVHDN	Single	Use this sub-menu to turn Auto Power Off on or off. See "Turning Off the Projector" in the "User's Guide (Basic Operation)" for more information. On*: Select this option to turn on Auto Power Off. Off: Select this option to turn off Auto Power Off.
Power On Password	RCVHDN	Single	You can configure the projector to require input of a password before operation is enabled. For details, see "Password Protecting the Projector" on page 19.
Direct Power On	RCVHDN	Single	Use this sub-menu to turn Direct Power On on or off. See "Direct Power On" on page 18 for more information. On: Select this option to turn on Direct Power On. Off*: Select this option to turn off Direct Power On.  Important! _____ While Direct Power On is enabled, the projector will turn off automatically if no key operation is performed and no signal input is received within about 10 minutes after it is turned on. This is true regardless of the current Auto Power Off setting.

Setting Name	Input	Setting Unit	Description
Language	RCVHDN	Single	Use this sub-menu to specify the language to use for messages, setup menus, etc. English / French / German / Italian / Spanish / Swedish / Chinese (Simplified) / Chinese (Traditional) / Korean / Japanese
Restore Menu Defaults	RCVHDN	Single	This sub-menu returns all of the sub-menu items on the Option Settings 1 main menu to their initial default settings. <ul style="list-style-type: none"> ● The language setting and the password are not returned to their initial factory defaults. ● Restoring menu defaults when there is no input signal will restore defaults for the currently selected input source. ● The "Auto Adjust" item is returned to its initial default only when RGB input is selected for the input source. All of the other items are returned to their initial defaults regardless of the currently selected input source.

Option Settings 2 Main Menu

Setting Name	Input	Setting Unit	Description
Zoom Memory	RCVHDN	Single	<p>Use this sub-menu to turn zoom memory on or off. Zoom memory lets you save the zoom setting when the projector is turned off, so it can be restored automatically the next time the projector is turned on.</p> <p>On*: Select this option when you want to restore the zoom setting that was in effect when the projector was last turned off, whenever it is turned on.</p> <p>Off: Select this option when you want the image to be projected at its maximum size whenever you turn on the projector.</p>
Pointer	RCVHDN	Single	<p>Use this sub-menu to specify the type of pointer that appears first when you press the [POINTER] key.</p>
HDMI Audio Out	RCVHDN	Single	<p>Specifies whether the input audio signal should be output from the projector's built-in speaker or to the line output.</p> <p>Speaker*: Outputs the audio signal being input to the HDMI port from the speaker.</p> <p>Line: Outputs the audio signal being input to the HDMI port from the AV terminal.</p>
High Altitude	RCVHDN	Single	<p>Use this sub-menu to turn the high-altitude fan speed setting on or off in accordance with the altitude of the area where you are using the projector.</p> <p>On: Select this setting when using the projector in a high altitude (1,500 to 3,000 meters above sea level) area where air is thin. This setting increases cooling efficiency.</p> <p>Off*: Select this setting at normal altitudes (up to 1,500 meters).</p> <p> Important! _____ Do not use this projector at altitudes greater than 3,000 meters above sea level.</p>
Restore Menu Defaults	RCVHDN	Single	<p>This sub-menu returns all of the sub-menu items on the Option Settings 2 main menu to their initial default settings.</p>

Operational Info Main Menu

Setting Name	Input	Setting Unit	Description
Input Signal	RCVHDN	Source Specific	This sub-menu item shows the currently selected input signal (RGB, Component, or VIDEO). "- - -" is indicated here when there is no input signal.
Signal Name	RCVHD	Source Specific	This sub-menu item shows the signal name of the signal being input to the projector. For details about signal names, see "Signal Name" under "Supported Signals" on page 52.
Resolution	R H	Single	This sub-menu item appears only when RGB is the input signal. It shows the number of vertical pixels of resolution of the RGB input signal.
Horizontal Frequency	RCVHD	Source Specific	This sub-menu item shows the horizontal frequency of the input signal.
Vertical Frequency	RCVHD	Source Specific	This sub-menu item shows the vertical frequency of the input signal.
Scan System	RC HD	Source Specific	This sub-menu item appears only when RGB or component is the input signal, and shows the scanning frequency of the input signal. The input signal is interlace or non-interlace for an RGB signal input, and interlace or progressive for a component signal input.
Lamp Time	RCVHDN	Single	This sub-menu item shows the cumulative number of hours the current lamp has been used to date. Use this value as a reference when deciding whether or not the current lamp needs to be replaced. For details about replacing the lamp, see "Replacing the Lamp" on page 37.
Reset Lamp Time	RCVHDN	Single	Use this sub-menu item to reset the lamp time to 0 hours after replacing the lamp. For details about replacing the lamp and the lamp time reset operation, see "Replacing the Lamp" on page 37.

Restore All Defaults Main Menu

Setting Name	Input	Setting Unit	Description
Unit Operating Time	RCVHDN	Single	This sub-menu item shows the cumulative operating time of this unit. This time cannot be initialized.
Restore All Defaults	RCVHDN	Single	This sub-menu returns all sub-menu items on all main menus to their initial default settings. This operation can be performed regardless of the currently selected input source and regardless of whether or not a signal is currently being input. For details about this procedure, see "To restore all settings on the setup menu to their initial factory defaults" on page 23.

Cleaning the Projector

Periodically clean the projector exterior, lens, intake vents, and exhaust vents on a regular basis.



Important!

- Always make sure that the projector has cooled sufficiently before cleaning it. If the projector is turned on, perform the following steps before cleaning it.

- 1 Turn off the projector.**
- 2 Check to make sure that the POWER/STANDBY indicator has changed to amber.**
- 3 Unplug the power cord from the power outlet, and allow the projector to cool down for about 60 minutes.**

Cleaning the Projector Exterior

Wipe the exterior of the projector with a soft cloth that has been moistened in a weak solution of water and a mild neutral detergent. Be sure to wring all excess moisture from the cloth before wiping.

Never use benzene, alcohol, thinner, or any other volatile agent for cleaning.

Cleaning the Lens

Carefully wipe the lens with a commercially available lens cloth or optical lens paper, like those for eyeglasses or camera lenses. When cleaning the lens, be very careful to avoid scratching it.

Cleaning Intake and Exhaust Vents

Dust and dirt tend to collect around the intake vents located on the back and both sides of the projector. Because of this, you should use a vacuum cleaner to clean away accumulated dust and dirt periodically as shown below.

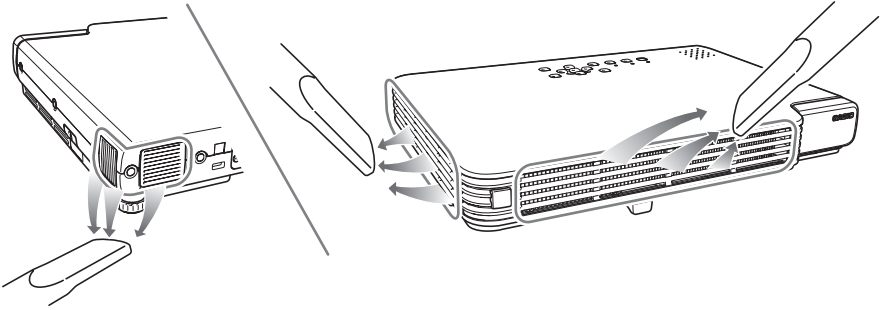

Important!

- Continued use of the projector after dust has accumulated around the intake vents can cause overheating of internal components and lead to malfunction.
- Certain operating conditions also can cause dirt and dust to accumulate around the projector's exhaust vents on the front. If this happens, use the same procedure as that described above to clean the exhaust vents.

Replacing the Lamp



Caution

- Continued use of a lamp that has passed its lamp life increases the risk of the lamp rupturing. Replace the lamp with a new one as soon as possible after the replacement message appears.

- The light source lamp is a consumable item. The average life of a lamp is approximately 2000 hours. After 2000 hours, a message appears to alert you to the need of lamp replacement. However, note that the characteristics of a particular lamp or lamp operating conditions can cause the lamp to start to go dim or even fail before the message appears.

To check the current lamp use time

1 Press the [MENU] key to display the setup menu.

2 Press the [▼] key to select the “Operational Info” main menu.

- The “Lamp Time” sub-menu item shows the number of hours that the current lamp has been used.

3 Press the [MENU] key to exit the setup menu.

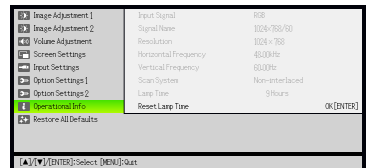

When to replace the lamp

The LAMP indicator starts to flash red and the message shown below appears whenever the lamp time exceeds 2000 hours.

It is time to replace the lamp. Use the procedure in the User's Guide to replace the lamp as soon as possible.

When this message appears, replace the lamp as soon as possible using the procedure under “Replacing the Lamp” on page 38.

Note that the above message will disappear about 10 seconds after you turn on the projector, even if you do not replace the lamp.

You will be able to continue using the projector without replacing the lamp until the lamp time reaches 2100 hours. At that time, the LAMP indicator will stop flashing and remain lit red, the following message will appear for about 10 seconds, and then the projector will turn off automatically.

The lamp has exceeded its service life! The projector will not turn on until you replace the lamp.

When this message appears, replace the lamp immediately using the procedure under “Replacing the Lamp” on page 38.

Replacing the Lamp

 **Caution**

- During normal use, the lamp and the area around it become extremely hot. Before replacing the lamp, turn off the projector and wait for the cool down operation (indicated when the POWER/STANDBY indicator is flashing amber) to finish. Next, disconnect the AC power cord from the projector, and wait for at least 60 minutes to allow it to cool down even further.
Touching the lamp or the area around it during operation or immediately after turning off the projector creates the risk of serious burn injury.
- Replace the lamp using the optional lamp cartridge only.

XJ-S43W Replacement Lamp	YL-4B
--------------------------	-------

- A mercury lamp with high internal pressure is used as the light source. A lamp that is weakened by impact, damage, or expiration of its lamp life may explode or fail to light if exposed to loud noise. Note that lamp life differs greatly from lamp to lamp, and is affected by conditions under which the lamp is used.
- Never touch the glass of the lamp with your fingers. Doing so can cause the lamp to rupture and shorten its life.
- A broken lamp can cause glass fragments to be scattered inside the lamp housing. Gas inside of the lamp housing may also be discharged from the projector's vent exhaust ports. Gas inside of the lamp includes mercury, so be sure to ventilate the area whenever the lamp breaks. Should you accidentally inhale gas fumes or should gas fumes get into your eyes, immediately contact a physician.
- Should the lamp break, take care to avoid personal injury on the glass fragments. Never try to replace a broken lamp on your own. Be sure to contact your original dealer or authorized CASIO service center to request replacement.
- The lamp contains mercury. Dispose of old lamps in accordance with the rules and regulations of your local jurisdiction.

To replace the lamp



Important!

- When replacing the lamp, use the special screwdriver that comes with the replacement lamp. The projector does not come with a screwdriver.

- 1** Turn off the projector and unplug its AC power cord.
- 2** Wait for about 60 minutes to allow the projector's current lamp to cool down completely.
- 3** Turn over the projector and place it on top of a desk or on some other stable surface.
- 4** Loosen the lamp cover screw, and then remove the lamp cover.

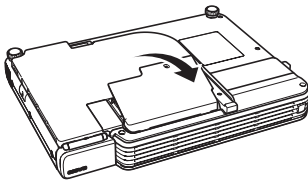
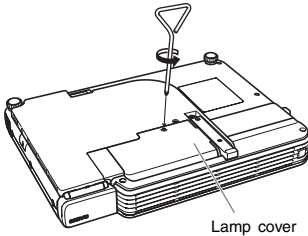

- 5** Loosen the three screws indicated by the ▲ marks.

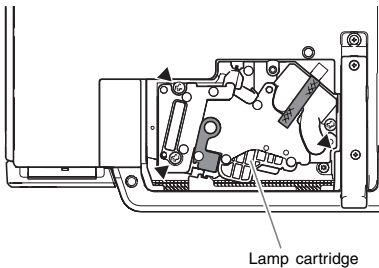

- 6** Pull up on the handle or ribbon to remove the lamp cartridge.

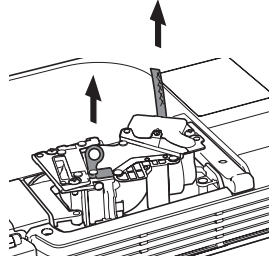

- 7** Insert the new lamp cartridge as far as it will go, as shown in the illustration.

- After inserting the lamp cartridge, stow the ribbon as shown in the illustration in step 5.

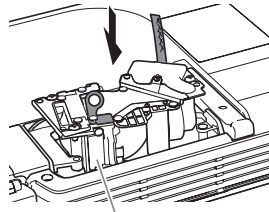

Make sure the grooves of the lamp cartridge align with the grooves of the lamp housing.



Caution

- Take care to avoid touching the lamp (glass) and the mirrors inside the projector. Doing so can cause the lamp to rupture, shorten lamp life, and otherwise affect lamp performance.

8 Secure the lamp cartridge with the three screws.

9 Return the lamp cover to its original position, and secure it with the screw.

- After replacing the lamp, be sure to perform the procedure under “Resetting the Lamp Time” on page 40.

Resetting the Lamp Time

The lamp time reset operation you need to perform depends on when you replace the lamp.

It is time to replace the lamp. Use the procedure in the User’s Guide to replace the lamp as soon as possible.

If you replace the lamp when the above message appears, use the procedure under “To reset the lamp time” on page 40.

The lamp has exceeded its service life! The projector will not turn on until you replace the lamp.

If you replace the lamp after the above message appears, use the procedure under “To reset the lamp time after exceeding the lamp life” on page 41.

To reset the lamp time

1 Turn on the projector.

2 Press the [MENU] key to display the setup menu.

3 Press the [▼] key to select “Operational Info”, and then press the [ENTER] key.

4 “Reset Lamp Time” is initially selected, so simply press the [ENTER] key.

- This causes the message “Reset Lamp Time?” to appear.

5 Press the [▲] key to select “Yes”, and then press the [ENTER] key.

- This resets the lamp time to 0 hours.

6 Press the [MENU] key to exit the setup menu.

- This causes the setup menu to disappear from the projected image.

To reset the lamp time after exceeding the lamp life

If you use the existing lamp until its life is exceeded, you will not be able to turn on the projector even after you replace the lamp with a new one. Perform the following procedure to initialize the lamp time in this case, which will make it possible to turn on the projector.

- 1 Use the bundled AC power cord to plug the projector into a power outlet.**
 - Connecting to a power outlet causes the POWER/STANDBY and LAMP indicators on the top of the projector to light red, which indicates that the lamp has exceeded its service life.
- 2 While holding down the projector's [◀] key, hold down the [AUTO] key for about five seconds.**
 - This will reset the lamp time, cause the POWER/STANDBY indicator to change from red to amber, and also cause the LAMP indicator to go out.
- 3 Press the [⏻] (power) key to ensure that the projector turns on normally.**

Error Indicators and Warning Messages

Warning messages and indicators let you know what the problem is when a projector error occurs.

When an error occurs, wait until cool down is complete and the fan stops before unplugging the AC power cord. If you unplug the AC power cord while the fan is still operating, an error may occur when you plug the AC power cord back in.

* For further information about items whose reference pages are marked with an asterisk, see “User’s Guide (Basic Operation)”.

Indicator/Error Message	Description and Required Action
POWER : Green steady TEMP : – LAMP : – Message : Internal temperature is too high. Check projector air vents for blockage.	The projector’s internal temperature is very high. Press the [ESC] key to clear the warning message and perform the following steps. ① Check for any blocking of the projector’s intake vents and exhaust vents, and make sure that there is sufficient space around the projector. See “Setup Precautions” (page E-13*). ② If there is dust accumulated around the intake vents and/or exhaust vents, turn off the projector and remove it. See “Cleaning the Projector” (page E-22*).
POWER : Amber flashing → Amber steady TEMP : Red flashing (1-second interval) → Turns off LAMP : – Message : Internal temperature is too high. The projector will turn off.	Power has turned off automatically due to internal overheating. Perform the following steps. ① Check for any blocking of the projector’s intake vents and exhaust vents, and make sure that there is sufficient space around the projector. See “Setup Precautions” (page E-13*). ② If there is dust accumulated around the intake vents and/or exhaust vents, remove it. See “Cleaning the Projector” (page E-22*). If there is no problem with the projector’s vents, confirm that the POWER/STANDBY indicator is lit amber (without flashing), and then turn power back on again. If the error occurs again when you turn power back on, contact your retailer or nearest authorized CASIO Service Center.
POWER : Amber flashing → Red steady TEMP : Red flashing (0.5-second interval) LAMP : – Message : –	Power has turned off automatically due to internal overheating. This causes a dialog box containing the text in the next item below to appear the next time you turn on the projector. Follow the steps that are provided.
POWER : Green steady TEMP : – LAMP : – Message : The projector has a history of turning off due to high temperature. Check air vents for blockage.	The last time you were using the projector, power turned off automatically due to internal overheating. Press the [ESC] key to clear the warning message and perform the following steps. ① Check for any blocking of the projector’s intake vents and exhaust vents, and make sure that there is sufficient space around the projector. See “Setup Precautions” (page E-13*). ② If there is dust accumulated around the intake vents and/or exhaust vents, turn off the projector and remove it. See “Cleaning the Projector” (page E-22*). ③ Disconnect the power cord from the projector and wait for all of the projector’s indicators to go out. Next, reconnect the power cord and turn the projector back on. If the error occurs again when you turn power back on, contact your retailer or nearest authorized CASIO Service Center.

Indicator/Error Message	Description and Required Action
POWER : Amber flashing → Red steady TEMP : Red steady LAMP : Red steady Message : There is a problem with the fan. The projector will turn off.	Power has turned off automatically due to a fan problem. Confirm that the POWER/STANDBY indicator is lit red (without flashing) and that the fan has stopped. After checking the POWER/STANDBY indicator, disconnect the power cord from the projector and wait for all of the projector's indicators to go out. Next, reconnect the power cord and turn projector power back on. If the error occurs again when you turn power back on, contact your retailer or nearest authorized CASIO Service Center.
POWER : Amber flashing → Red steady TEMP : Red steady LAMP : – Message : A system problem has occurred. The projector will turn off.	Power has turned off automatically due to a system problem. After confirming that the POWER/STANDBY indicator is lit red (without flashing), disconnect the power cord from the projector and wait for all of the projector's indicators to go out. Next, reconnect the power cord and turn the projector back on. If the error occurs again when you turn power back on, contact your retailer or nearest authorized CASIO Service Center.
POWER : Green steady TEMP : – LAMP : – Message : A system problem has occurred. Normal projection is not possible.	A system problem has occurred, which may cause problems with some functions. Turn off the projector, disconnect the power cord from the projector and wait for all of the projector's indicators to go out. Next, reconnect the power cord and turn the projector back on. If the error occurs again when you turn power back on, contact your retailer or nearest authorized CASIO Service Center. Press the [ESC] key to clear the warning message.
POWER : Green steady TEMP : – LAMP : – Message : There is some problem with the system. The audio function may not operate correctly.	
POWER : Green steady TEMP : – LAMP : – Message : There is some problem with the system. Movies may not play back correctly.	
POWER : Green steady TEMP : – LAMP : – Message : Zoom and focus cannot be performed for some reason. Try turning the projector off and then back on again. If this message reappears, request servicing.	Zoom and focus cannot be performed due to some trouble in the optical drive circuit. Turn off the projector and then turn it back on again. If the error occurs again when you turn power back on, contact your retailer or nearest authorized CASIO Service Center. Press the [ESC] key to clear the warning message.
POWER : Amber flashing → Red steady TEMP : Red steady LAMP : – Message : –	The projector was turned off automatically due to some problem that was probably caused by external digital noise or some other reason. Confirm that the POWER/STANDBY indicator is lit red (without flashing). After checking the POWER/STANDBY indicator, disconnect the power cord from the projector and wait for all of the projector's indicators to go out. Next, reconnect the power cord and turn projector power back on. If the error occurs again when you turn power back on, contact your retailer or nearest authorized CASIO Service Center.

Indicator/Error Message	Description and Required Action
POWER : Amber flashing → Red steady TEMP : Red flashing (0.5-second interval) LAMP : Red flashing (0.5-second interval) Message : –	The projector was turned off automatically because the lamp turned off or did not turn on. After confirming that the POWER/STANDBY indicator is lit red (without flashing), unplug the power cord. Wait for a short while and then plug it back in and turn on the projector again. If the error occurs again when you turn power back on, wait until the projector cools down and then replace the lamp (page 37). If the lamp does not light after you replace it, contact your retailer or nearest authorized CASIO Service Center.
POWER : Amber flashing → Red steady TEMP : Red flashing (2-second interval) LAMP : Not lit or red flashing Message : –	Power has turned off automatically due to a projector memory error. Confirm that the POWER/STANDBY indicator is lit red (without flashing). After checking the POWER/STANDBY indicator, disconnect the power cord from the projector and wait for all of the projector's indicators to go out. Next, reconnect the power cord and turn projector power back on. If the error occurs again when you turn power back on, contact your retailer or nearest authorized CASIO Service Center.
POWER : Amber flashing → Red steady TEMP : Amber flashing (1-second interval) LAMP : – Message : –	Power has turned off automatically because the lamp cover is open. Perform the following steps. ① After confirming that the POWER/STANDBY indicator is lit red (without flashing), disconnect the power cord from the projector. ② Check to make sure that the lamp cover is closed. ③ Plug the power cord back in and turn the projector back on again. If the error occurs again when you turn power back on, contact your retailer or nearest authorized CASIO Service Center.
POWER : Green steady TEMP : – LAMP : Red flashing (1-second interval) Message : It is time to replace the lamp. Use the procedure in the User's Guide to replace the lamp as soon as possible.	It is time to replace the lamp. Replace the lamp following the steps under "Replacing the Lamp" (page 37). Press the [ESC] key to clear the warning message.
POWER : Amber flashing → Red steady TEMP : – LAMP : Red steady Message : The lamp has exceeded its service life! The projector will not turn on until you replace the lamp.	The allowable life for the lamp has been exceeded, and the projector will not turn on. Replace the lamp following the steps under "Replacing the Lamp" (page 37).

Connecting to a Component Video Output Device

Some video devices are equipped with a component video output terminal. You can use an optionally available component video cable (YK-3) to connect the COMPUTER terminal of the projector to the component video output terminal of a video device.



Important!

- Always turn off the projector and the video device before connecting them.

Projector

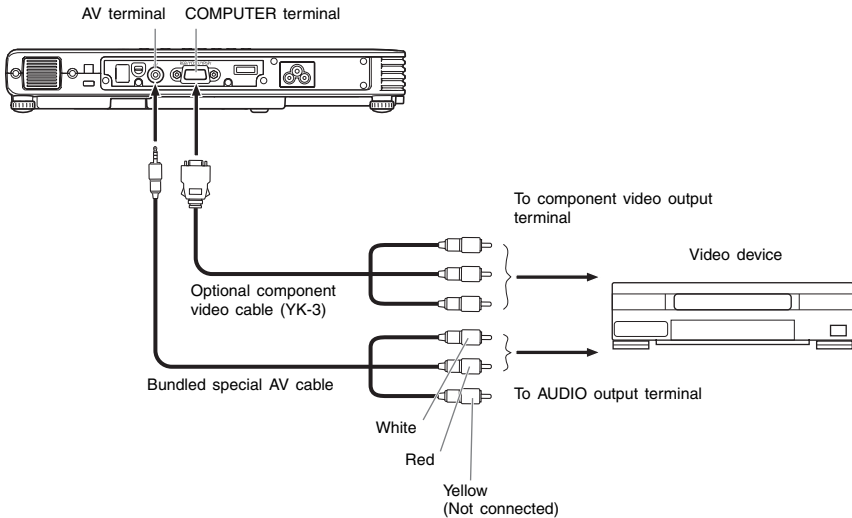

- You can use the optional YK-3 component video cable to connect to pin jack (RCA) type component video output terminals. The projector does not support connection to any other type of terminal.
- Component video output terminals come in 3-terminal sets: Y·Cb·Cr or Y·Pb·Pr. Be sure to match the colors of the plugs on the optional YK-3 component video cable with the colors of the terminals (Green: Y; Blue: Cb/Pb; Red: Cr/Pr).
- Note that connection only to an analog component video output terminal is supported. Connection to a digital output terminal is not supported.

Connecting the HDMI Output of a Video Device or Computer to the Projector

The projector supports projection and output of HDMI video and audio output from a computer or video device.



Important!

- Turn off the projector and the computer or video device before connecting them.

Projector

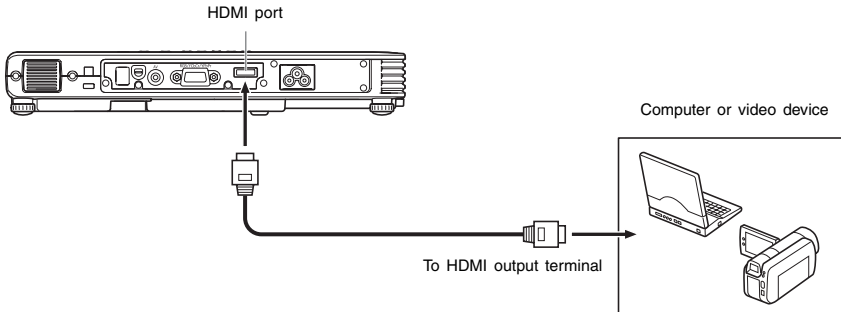

- You will need to obtain a commercially available HDMI cable with a connector that matches the terminal of the output device on one end and a connector that matches the projector's HDMI port (HDMI Type A Socket) on the other end.
- For information about HDMI video signal supported by the projector, see page 54.
- The projector supports L-PCM 32KHz, 44.1KHz, and 48KHz HDMI audio signals.

Remote Controller Signal Range

When performing an operation on the remote controller, point it at the remote control signal receiver on the back or front of the projector. The following illustration shows the range of the remote controller signal.

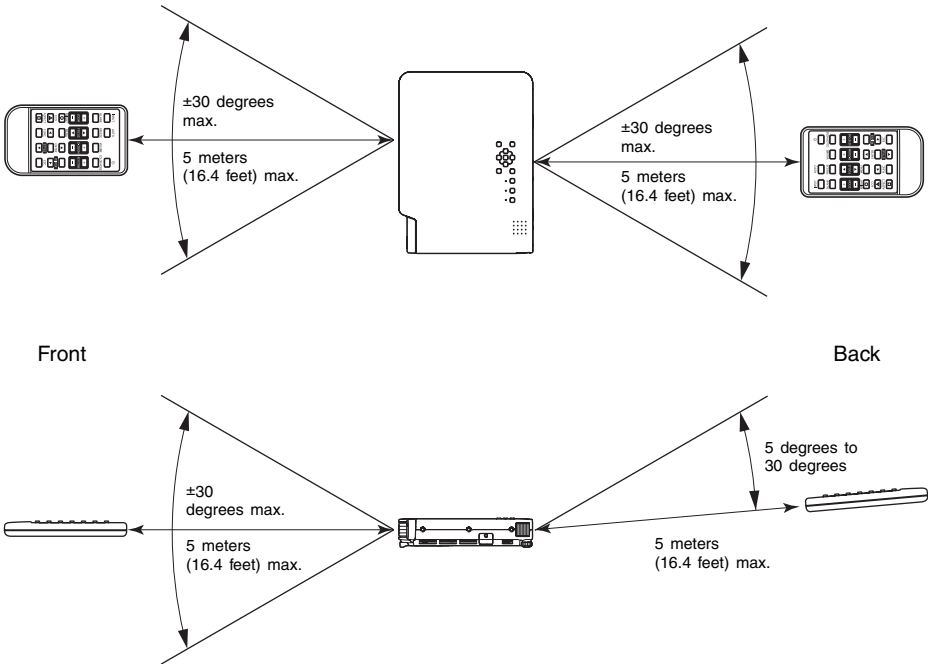

Remote Controller Range

The allowable distance between the remote controller and the projector is less when there is a sharp angle between the remote controller and the remote control signal receiver.



Important!

To avoid running down the battery, store the remote control unit so its buttons are not pressed inadvertently.

Replacing the Remote Controller Battery

Caution

RISK OF EXPLOSION IF BATTERY IS REPLACED BY AN INCORRECT TYPE.
DISPOSE OF USED BATTERIES ACCORDING TO THE INSTRUCTIONS.

Caution

Misuse of a battery can cause it to leak and stain the area around it, or to explode, creating the risk of fire and personal injury. Make sure that you always observe the following precautions.

- Take care that the battery is oriented correctly when you load it.
- Use only battery type that is specified for use with the remote controller.

- 1** Hook your fingernail on the groove of the battery holder on the back of the remote controller. While holding down the release on the side (①), pull out the holder (②).

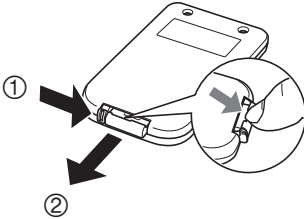

- 2** Place the battery (CR2025) onto the battery holder.

- Make sure that the plus (+) side of the battery is facing upwards (so you can see it). Take care that you do not install the battery upside down.

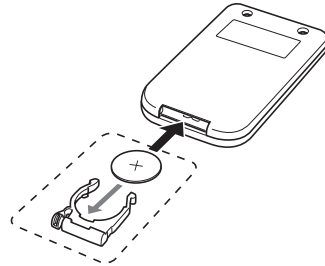

- 3** Replace the battery holder back into the remote controller.

Projection Distance and Screen Size

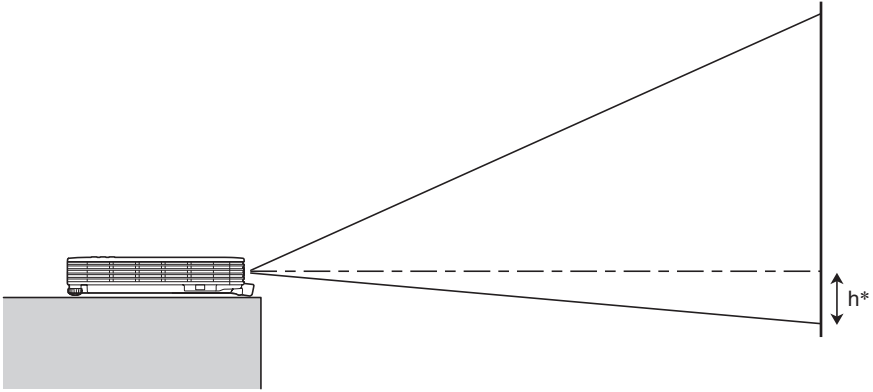

The following table shows the relationship between the distance and projected image size.

Projection Size		Approximate Projection Distance		
Screen Size	Diagonal (cm)	Minimum Distance (m / feet)	Maximum Distance (m / feet)	h^* (cm / inch)
40	102	1.0 / 3.28	1.9 / 6.23	9 / 3.54
60	152	1.4 / 4.59	2.8 / 9.19	14 / 5.51
80	203	1.9 / 6.23	3.8 / 12.47	18 / 7.09
100	254	2.4 / 7.87	4.8 / 15.75	23 / 9.06
150	381	3.6 / 11.81	7.2 / 23.62	34 / 13.39
200	508	4.8 / 15.75	9.6 / 31.50	45 / 17.72

* h = Height from the center of the lens to the bottom edge of the projection screen.





Important!

Note that the distances provided above are for reference only.

Aspect Ratio Setting and Projection Image

The following shows how images are projected in accordance with the type of the input signal and the aspect ratio setting of the projector.

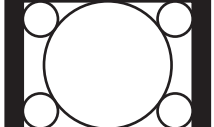
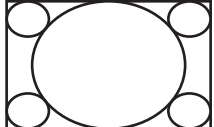
Input source: RGB or HDMI (PC)

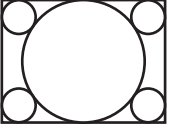
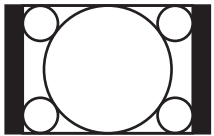
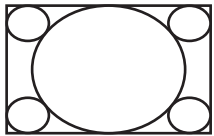
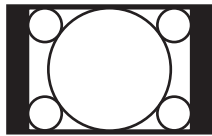
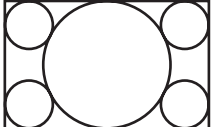
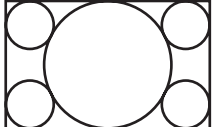
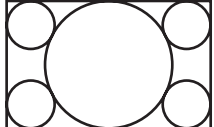
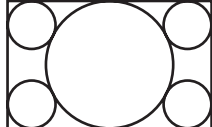
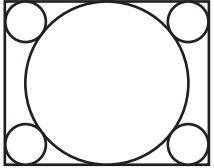
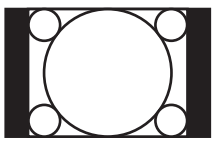
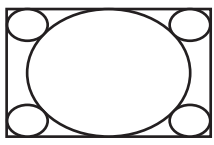
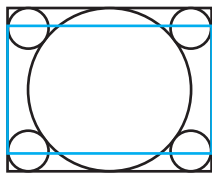
Input Signal	Normal	Full	True
SVGA  800×600			
XGA  1024×768			
WXGA  1280×800			
SXGA  1280×1024			

* The blue boundary indicates the projection area.

Input source: Video, component or HDMI (DTV)

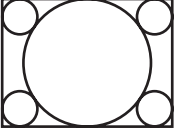
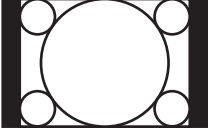
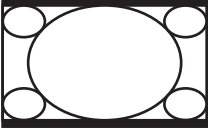
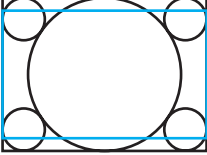
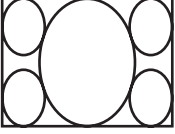
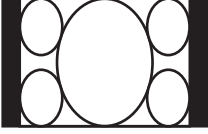
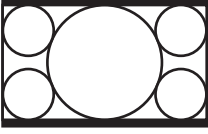
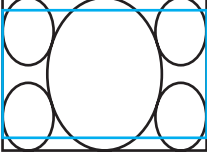
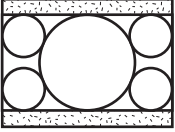
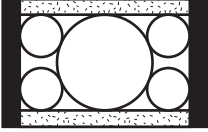
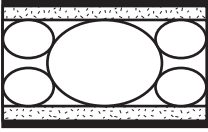
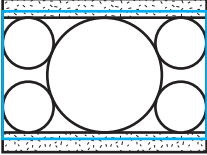
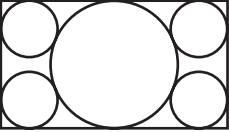
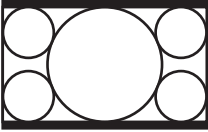
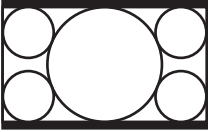
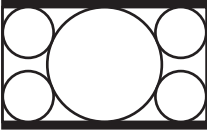
Input Signal	Normal	16:9	Letter Box
<p>4:3 Aspect Image</p> 			
<p>Squeezed Image</p> 			
<p>Letter Box Image</p> 			
<p>16:9 Aspect Image</p> 			

* The blue boundary indicates the projection area.

Supported Signals

RGB Signal

	Signal Name	Resolution	Horizontal Frequency (kHz)	Vertical Frequency (Hz)	
VESA	640 × 480/60	640 × 480	31.5	60	
	640 × 480/72	640 × 480	37.9	73	
	640 × 480/75	640 × 480	37.5	75	
	640 × 480/85	640 × 480	43.3	85	
	800 × 600/56	800 × 600	35.2	56	
	800 × 600/60	800 × 600	37.9	60	
	800 × 600/72	800 × 600	48.1	72	
	800 × 600/75	800 × 600	46.9	75	
	800 × 600/85	800 × 600	53.7	85	
	1024 × 768/60	1024 × 768	48.4	60	
	1024 × 768/70	1024 × 768	56.5	70	
	1024 × 768/75	1024 × 768	60.0	75	
	1024 × 768/85	1024 × 768	68.7	85	
	1152 × 864/75	1152 × 864	67.5	75	
	1280 × 768/60	1280 × 768	47.8	60	
	1280 × 800/60	1280 × 800	49.7	60	
	1280 × 960/60	1280 × 960	60.0	60	
	1280 × 960/85	1280 × 960	85.9	85	
	1280 × 1024/60	1280 × 1024	64.0	60	
	1280 × 1024/75	1280 × 1024	80.0	75	
	1280 × 1024/85	1280 × 1024	91.1	85	
	1360 × 768/60*	1360 × 768	47.7	60	
	1400 × 1050/A*	1400 × 1050	65.3	60	
	1440 × 900/60	1440 × 900	55.9	60	
	1680 × 1050/60	1680 × 1050	65.3	60	
	1600 × 1200/60	1600 × 1200	75.0	60	
	Other	1152 × 864/70	1152 × 864	64.0	70
		1400 × 1050/B*	1400 × 1050	64.0	60

* If these signals do not project correctly, change the “Option Settings 1 → Auto Adjust” setting to “2” (page 30).

Component Signal

	Signal Name	Horizontal Frequency (kHz)	Vertical Frequency (Hz)
HDTV	1080p/50	62.5	50
	1080p/60	67.5	60
	720p/50	37.5	50
	720p/60	45.0	60
	1080i/50	31.3	50
	1080i/60	33.7	60
SDTV	576p50	31.3	50
	576i50	16.6	50
	480p60	31.5	60
	480i60	15.7	60

Video Signal

Signal Name	Horizontal Frequency (kHz)	Vertical Frequency (Hz)
NTSC	15.7	60
NTSC4.43	15.7	60
PAL	15.6	50
PAL-M	15.7	60
PAL-N	15.6	50
PAL60	15.7	60
SECAM	15.6	50

* Listing of a device in the above table does not guarantee that you will be able to display its images correctly.

HDMI Signal

Signal Name	Horizontal Frequency (kHz)	Vertical Frequency (Hz)
640 × 480/60	31.469	59.94
800 × 600/60	37.879	60.317
1024 × 768/60	48.363	60.004
1280 × 768/60	47.776	59.87
1280 × 800/60	49.702	59.81
1280 × 960/60	60	60
1280 × 1024/60	63.981	60.02
1400 × 1050/60	65.317	59.978
1600 × 1200/60	75	60
SDTV (480p)	31.469	59.94
SDTV (576p)	31.25	50
HDTV (720p) (50)	37.5	50
HDTV (720p) (60)	45	60
HDTV (1080i) (50)	28.125	50
HDTV (1080i) (60)	33.75	60
HDTV (1080p) (50)	56.25	50
HDTV (1080p) (60)	67.5	60

CASIO®

CASIO COMPUTER CO.,LTD.
6-2, Hon-machi 1-chome
Shibuya-ku, Tokyo 151-8543, Japan