

Play Dome



Product features may vary from picture above.

Model Number: B0003

Please keep this instruction sheet for future reference, as it contains important information.
Adult assembly is required.

Tool needed for assembly: Phillips Screwdriver (not included).

Use only for a child who is unable to push up on hands and knees, pull up or sit unassisted.

Fisher-Price®

www.fisher-price.com

Warnings

WARNING

Failure to follow these warnings and instructions could result in serious injury or death.

To reduce the risk of Sudden Infant Death Syndrome (SIDS), normal healthy infants should always sleep on their backs unless otherwise advised by a pediatrician.

- Infants can suffocate:
 - In gaps between an extra pad and side of the dome.
 - On soft bedding.
- Never add a mattress, pillow, comforter or padding. Use **ONLY** the pad provided by the manufacturer.
- To prevent falls:
 - Do not use this product when infant begins to push up on hands and knees.
 - Never place product on an elevated surface.
- To prevent strangulation:
 - Never place items with strings, such as hood strings or pacifier cords, around a child's neck.
 - Never place product near a window where cords from blinds or drapes can strangle a child.
- Never move this product with child in it.
- Never leave child unattended.

Consumer Information

Occasionally a consumer may experience a problem with one of our products. If this should happen, please call us toll-free, rather than return this product to the store. Usually, we can solve the problem over the telephone or send you replacement parts.

Please call Fisher-Price® Consumer Relations, toll-free at **1-800-432-5437**, 8 AM - 6 PM EST Monday through Friday. Hearing-impaired consumers using TTY/TDD equipment, please call 1-800-382-7470.

Or, write to:
Fisher-Price® Consumer Relations
636 Girard Avenue
East Aurora, New York 14052

For other countries, outside the United States:

Canada: call 1-800-567-7724, or write to: Mattel Canada Inc., 6155 Freemont Blvd., Mississauga, Ontario L5R 3W2.

Great Britain: telephone 01628 500302.

Australia: Mattel Australia Pty. Ltd., 658 Church Street, Locked Bag #870, Richmond, Victoria 3121 Australia.
Consumer Advisory Service 1300 135 312.

New Zealand: 16-18 William Pickering Drive, Albany 1331, Auckland.

Parts



Pad



2 Covers

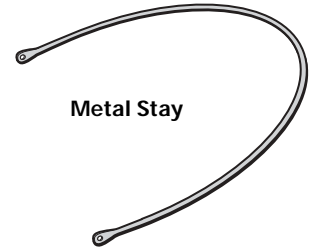

Metal Stay

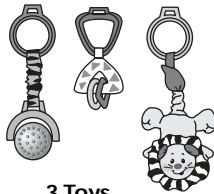

3 Toys

(Toys may be different than shown.)

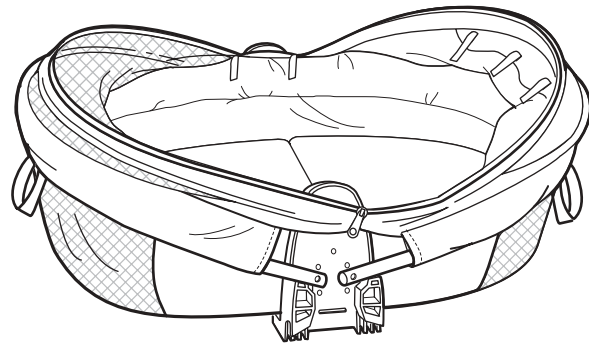

Base

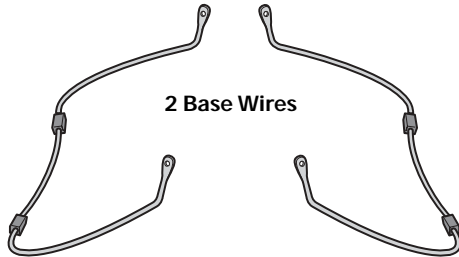

2 Base Wires



Plastic Stay



Spring - 4

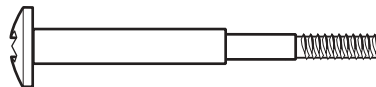

M4 x 1¹³/₁₆" Screw - 2



M4 Lock Nut - 2
(Inside Base Frames)

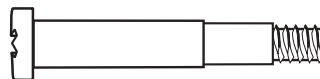

M5 x 1¹/₂" Screw - 8



M5 Lock Nut - 8
(Inside Base Frames)

All Shown Actual Size

Assembly

IMPORTANT! Before each use or assembly, inspect this product for damaged hardware, loose joints, missing parts or sharp edges. **DO NOT** use if any parts are missing or broken. Contact Fisher-Price® for replacement parts and instructions if needed. Never substitute parts.

⚠ CAUTION

This package contains small parts in its unassembled state. Adult assembly is required.

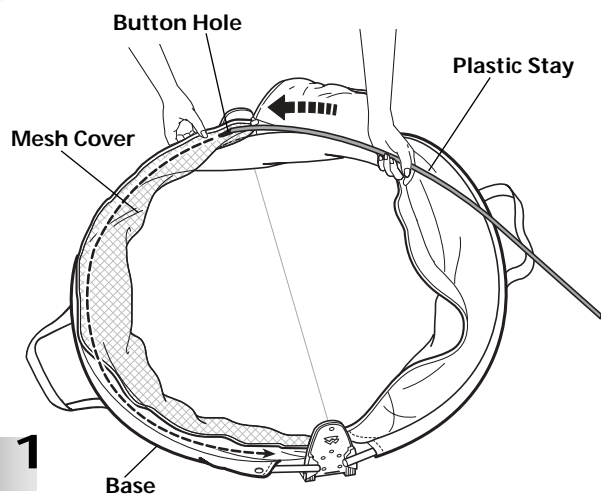

- 1
- Open the base and position it upright on a flat surface, as shown.
 - Locate the end of the base with the mesh cover. Insert the entire **plastic stay** into one of the button holes in the **mesh cover**.
 - Be sure to tuck the plastic stay away from the button hole in the mesh cover.

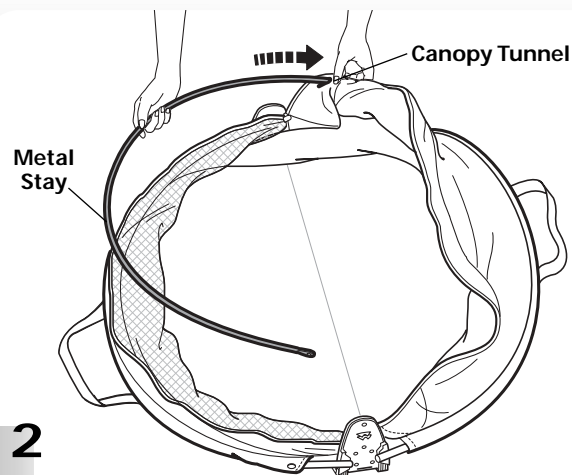

- 2
- Insert the metal stay through the canopy tunnel.

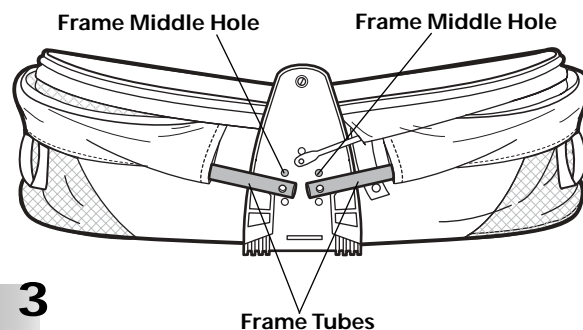

- 3
- Position the ends of the frame tubes against the **middle** holes in a frame.

Assembly

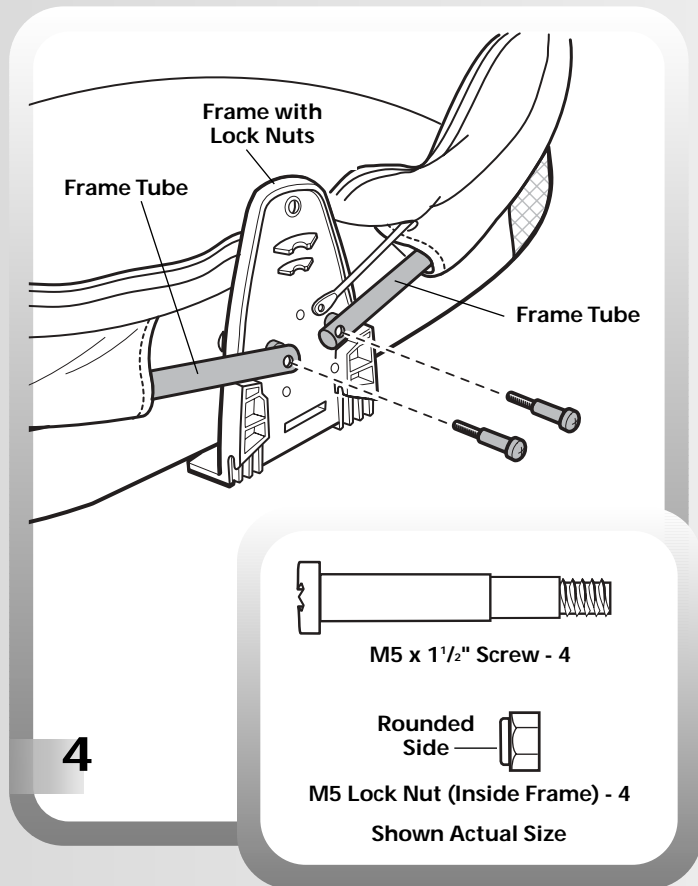

- Insert an M5 x 1 1/2" screw through each frame tube and into the **middle** hole in the frame with lock nuts.

Hint: The lock nuts have been factory assembled to the frame. During shipment, the lock nuts may have fallen out of the frame. If this has happened, please fit the lock nuts back into the **middle** hexagonal holes in the frame, so that the rounded side of the lock nuts face out. You may find it easier to access the hexagonal openings on the back of the frame if you push the base up, so that the fabric is out of the way.

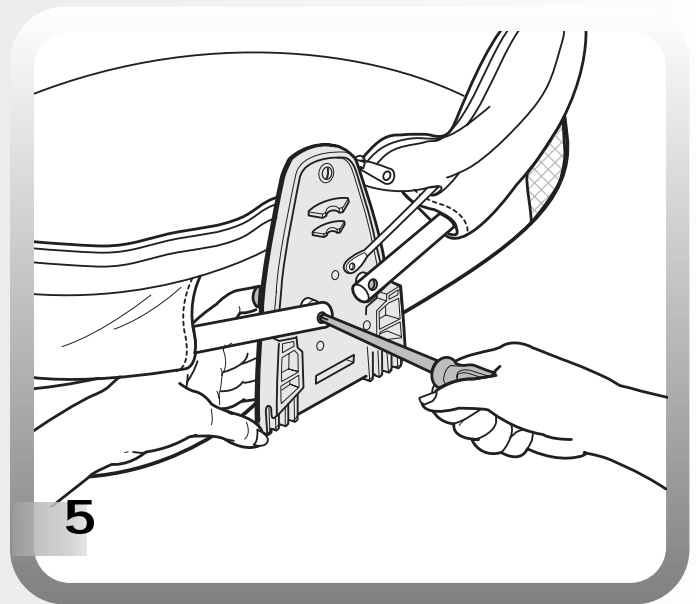

- Tighten the screws with a Phillips screwdriver. Do not over-tighten.
- Repeat assembly steps 3 - 5 to attach the other ends of the frame tubes to the frame on the other side of the base.

Assembly

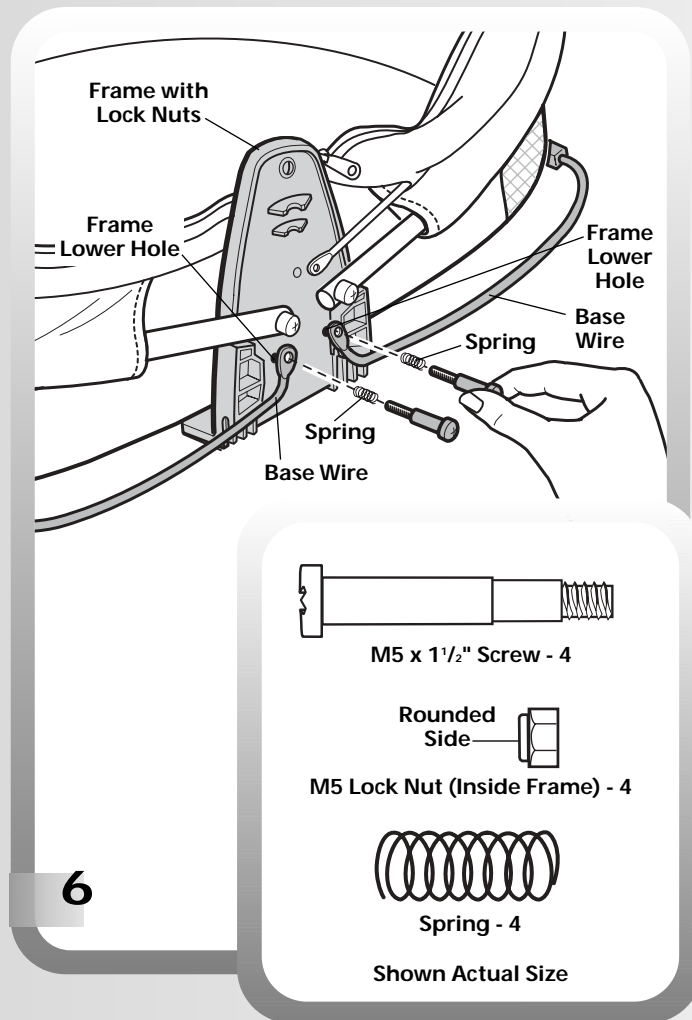

- Position the base wires around the base so that the **ends point upward** and are against the **lower** holes in a frame.
- Place the springs onto the M5 x 1 1/2" screws.
- Insert the M5 x 1 1/2" screws with spring through the base wires and into the **lower** holes in the frame with lock nuts.

Hint: The lock nuts have been factory assembled to the frame. During shipment, the lock nuts may have fallen out of the frame. If this has happened, please fit the lock nuts back into the **lower** hexagonal holes in the frame, so that the rounded side of the lock nuts face out. You may find it easier to access the hexagonal holes on the back of the frame if you push the base up, so that the fabric is out of the way.

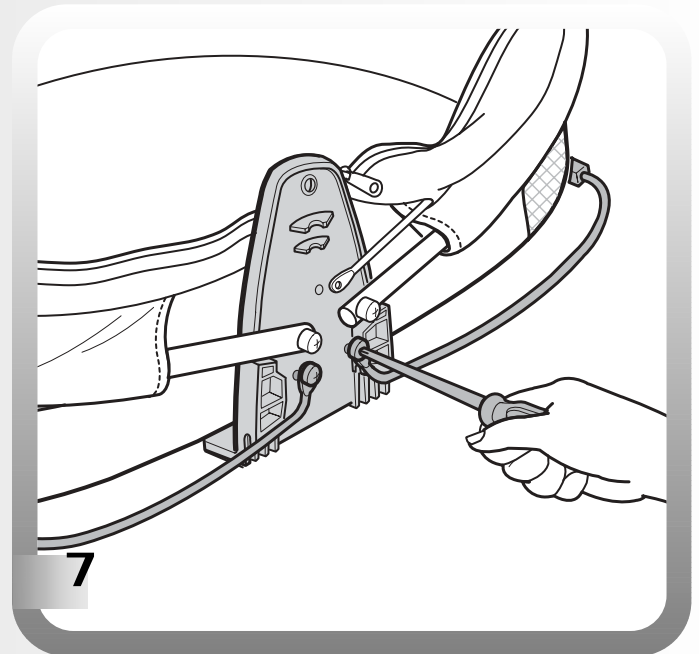

- Tighten the screws with a Phillips screwdriver. Do not over-tighten.
- Repeat this procedure to attach the other ends of the base wires to the frame with lock nuts on the other side of the base.

Assembly

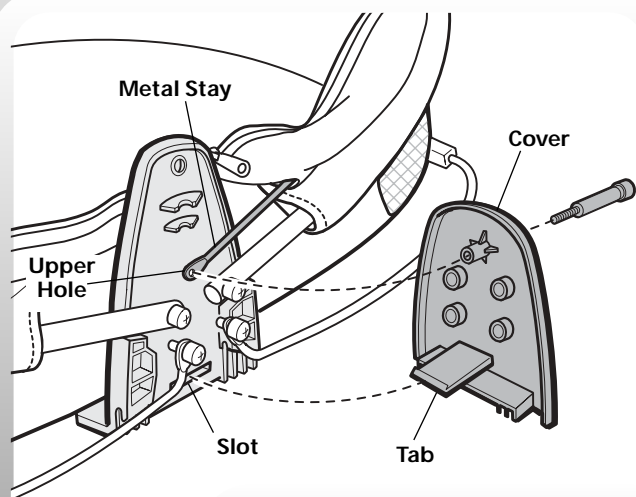

8

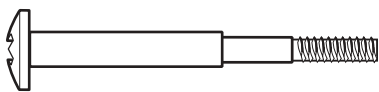

M4 x 1¹³/₁₆" Screw - 2

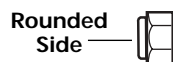

M4 Lock Nut (Inside Frame) - 2

Shown Actual Size

- Position one end of the metal stay against the **upper** hole in a frame.
- Insert an M4 x 1¹³/₁₆" screw through the hole in the cover.
- Fit the end of the screw through the hole in the metal stay, the **upper** hole in the frame and into the lock nut.

Hint: A lock nut has been factory assembled to the frame. During shipment, the lock nut may have fallen out of the frame. If this has happened, please fit the lock nut back into the **upper** hexagonal hole in the frame, so that the rounded side of the lock nut faces out. You may find it easier to access the hexagonal hole on the back of the frame if you push the base up, so that the fabric is out of the way.

- Push on the cover to insert and “snap” the tab on the cover into the slot in the frame. **Make sure you hear a “snap”!**

- Tighten the screw with a Phillips screwdriver. Do not over-tighten.
- Repeat this procedure to attach the other end of the metal stay and the remaining cover to the frame on the other side of the base.

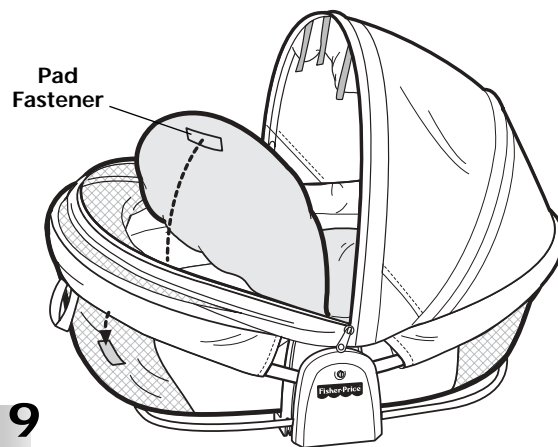

9

- Fasten the pad fasteners to the base fasteners.
- IMPORTANT!** Assembly is now complete, but the Activity Dome is **NOT** ready for use. Please refer to the Set-Up & Use instructions, beginning with step 2.

Set-Up & Use

To Unfold

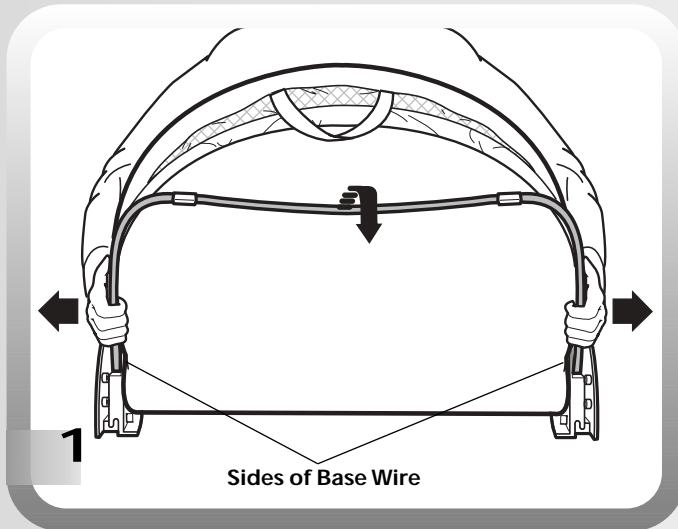

- Position the product upright on a flat surface.
- Grasp both sides of a base wire. Pull both sides of the base wire outward and then let the base wire rotate down.

Note: If the base wire does not freely rotate down, pull the sides of the base wire further outward.

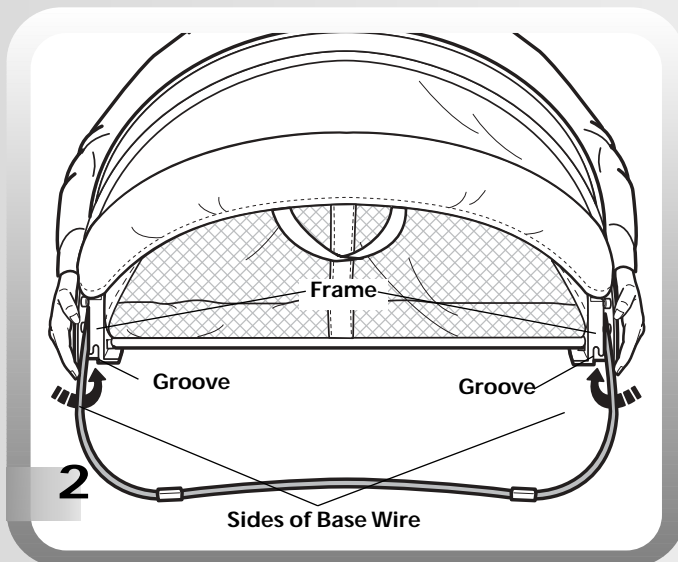

- Lift the product slightly so that each side of the base wire "snaps" into the groove in each frame. **Make sure you hear a "snap"!**

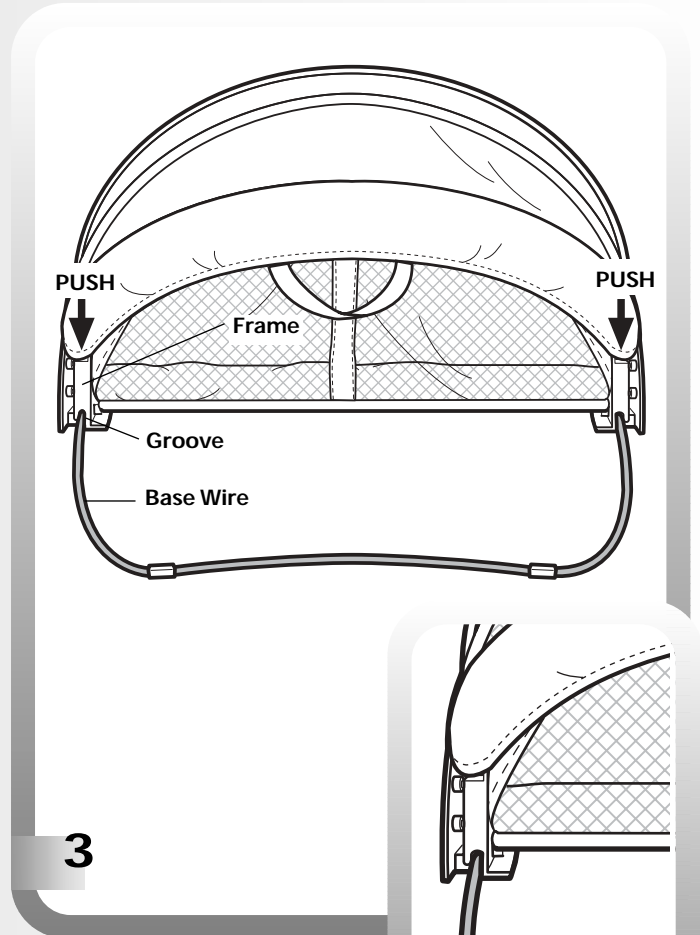

- Push down on the product to be sure each side of the base wire is in the correct position. The base wire should rest in the groove in each frame.
- Repeat Set-Up & Use steps 1- 3 to unfold the other base wire.

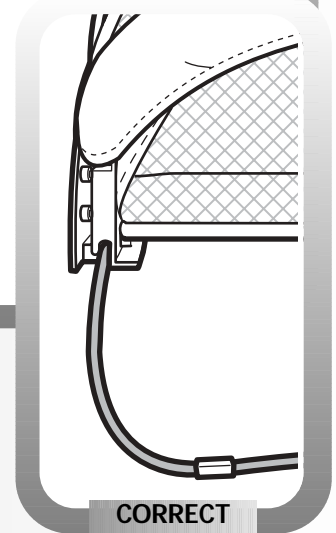

Set-Up & Use

Using the Canopy

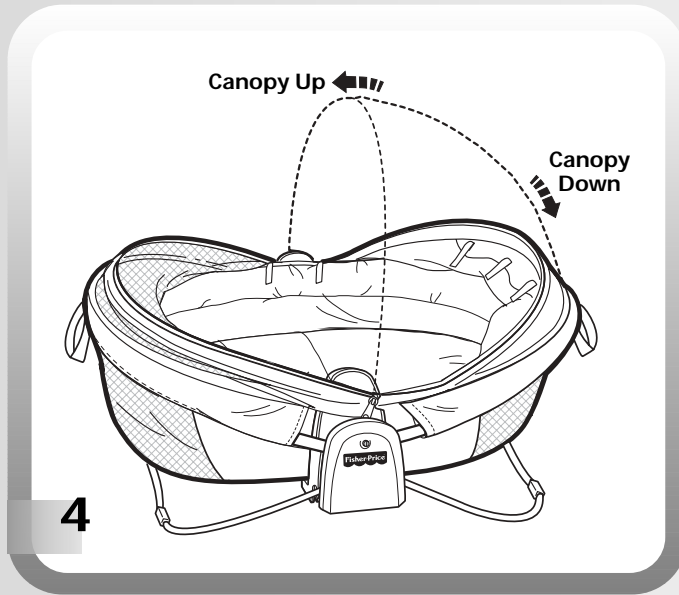

- Adjust the canopy up or down.

Using the Mesh Cover

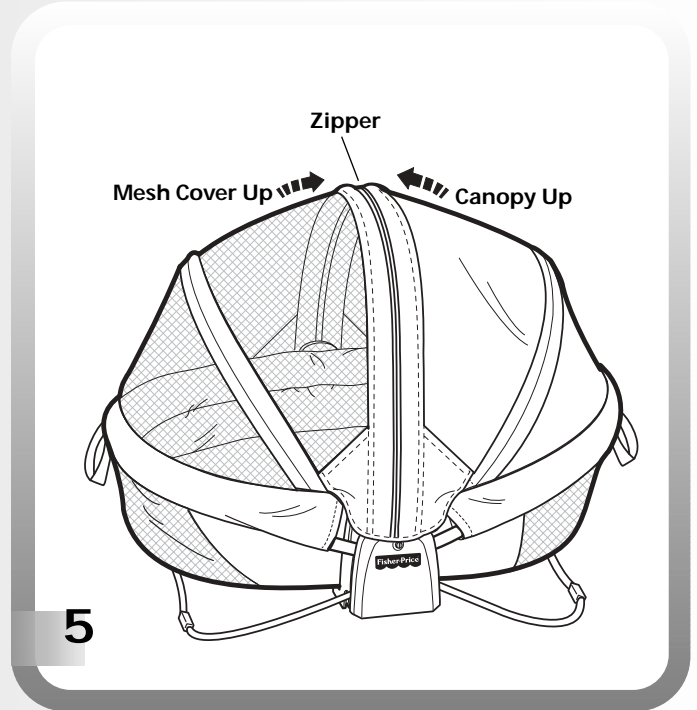

- Adjust the canopy and mesh cover up.
- While holding the mesh cover up, fasten the zipper closed.

Set-Up & Use

Canopy Strap

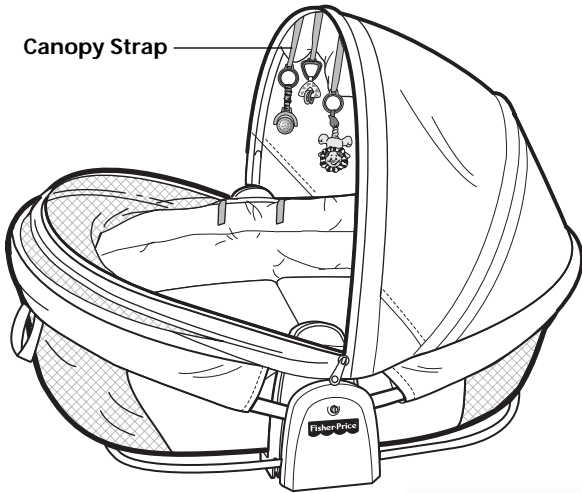

6

- Fit the canopy strap through the slot in a toy ring. Fasten the strap.
- Or, attach the toys to the straps inside the dome (see step 7).

Hint: Pull the lion's head for a short tune.

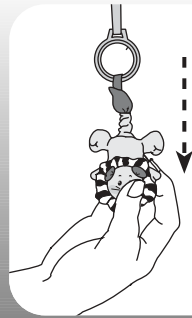

Strap

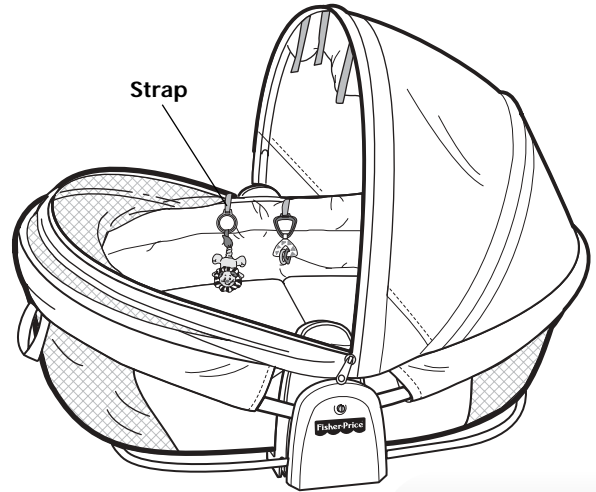

7

- Fit a strap inside the dome through the slot in a toy ring. Fasten the strap.
- Or, attach the toys to the straps on the canopy (see step 6).

Hint: Pull the lion's head for a short tune.

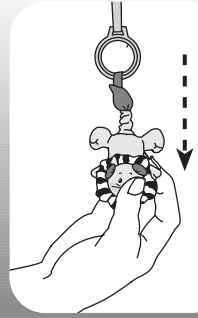

Set-Up & Use

To Fold for Portability

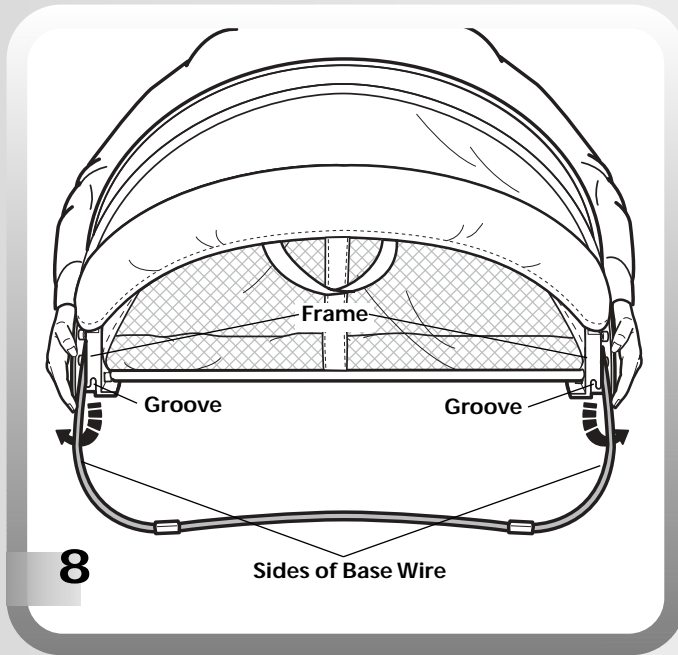

- Grasp both sides of a base wire.
- While lifting the product slightly, pull both sides of the base wire outward to remove the base wire from the groove in each frame.

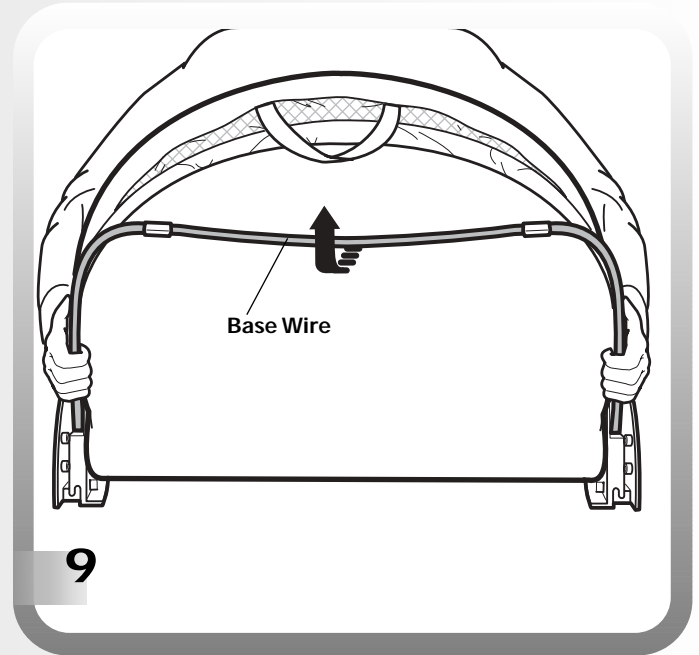

- Rotate the base wire up.
- Repeat this procedure to fold the other base wire.

Care

The pad is machine washable. Wash the pad separately in cold water on the gentle cycle. Do not use bleach. Tumble dry separately on low heat and remove promptly. The fabric, frame and toys may be wiped clean using a mild cleaning solution and a damp cloth.

Note: Do not dispose of the musical toy in a fire. The battery(ies) inside the toy may explode or leak.

FCC Note (United States Only)

Note: This equipment has been tested and found to comply with the limits for a Class B digital device, pursuant to Part 15 of the FCC Rules. These limits are designed to provide reasonable protection against harmful interference in a residential installation. This equipment generates, uses and can radiate radio frequency energy and, if not installed and used in accordance with the instructions, may cause harmful interference to radio communications. However, there is no guarantee that interference will not occur in a particular installation. If this equipment does cause harmful interference to radio or television reception, which can be determined by turning the equipment off and on, the user is encouraged to try to correct the interference by one or more of the following measures:

- Reorient or relocate the receiving antenna.
- Increase the separation between the equipment and receiver.
- Consult the dealer or an experienced radio/TV technician for help.

Note: Changes or modifications not expressly approved by the manufacturer responsible for compliance could void the user's authority to operate the equipment.