

ÖKO-LAVAMAT 72630 update

The environmentally friendly washing machine

User information



Dear Customer,

Please read this instruction book carefully before using the appliance. Please ensure you fully understand the safety instructions on the first pages of this instruction book.

Retain the instruction book for future reference, and pass it on to any future owners.



The warning triangle and / or key words (**Warning!**, **Caution!**, **Important!**) give information that is important for your safety or the function of the appliance is highlighted. It is imperative that this information is observed.



1. This symbol guides you step by step through the operation of the appliance.

2. ...



This symbol gives you additional information and practical tips on using the appliance.



Tips and information about the economical and environmentally friendly use of the machine are marked with the clover leaf.

In the event of a malfunction, these operating instructions contain information on how to remedy these faults yourself. See the section "What to do if ..."

Printed on recycled paper.

Thinking ecologically means acting ecologically ...

Contents

Operating Instructions	6
Safety	6
Disposal	8
Environmental tips	8
Description of the Appliance	9
Front view	9
Detergent dispenser drawer	9
Control panel	10
Programme selector	10
Programme option buttons	12
Consumption data and wash times	13
What does UPDATE mean?	13
Before the first wash	14
Preparing a Wash Load	14
Sorting and preparing a wash load	14
Washing Types and Care Symbols	15
Detergents and Conditioners	16
Which detergent and conditioner?	16
How much detergent and conditioner?	16
Water softening	16
Running a washing cycle	17
Brief instructions	17
Setting the Washing Programme	18
Changing the spin speed/Selecting Rinse Hold	18
Setting the delay timer / soaking duration	19
Opening and closing the door	20
Loading the washing	20
Add detergent / conditioner	21
Starting the washing programme	22
Washing Programme Progress	22
Change the washing programme	23
Washing cycle is complete/Removing the washing.	24

Programme tables	25
Washing	25
Separate conditioning/starching	26
Separate rinse	26
Separate spin	26
Maintenance and Cleaning	27
Control panel	27
Detergent Dispenser Drawer	27
Washing Machine Drum	28
Main door	28
Cleaning the drain pump	29
What to do if...	30
Trouble Shooting	30
If the washing results are not satisfactory	34
Carrying out an emergency emptying	35
Additional Rinse (RINSE+)	36
Child Safety Feature	37
Installation and connection instructions	38
Installation Safety Precautions	38
Installation of the appliance	39
Transporting the appliance	39
Remove transport packaging	39
Installation-Site preparation	41
Installation on a Suspended Floor	41
Levelling the Appliance	42

Electrical Connection	43
Water connection	45
Water pressure	45
Inlet Hose Connection	46
Water Drainage	47
Pump head of greater than 1m	48
Technical data	49
Dimensions	49
Warranty conditions	50
Index	54
Service & Spare Parts	55

Operating Instructions



Safety

The safety features of AEG electrical appliances comply with accepted technical standards and the German Appliance Safety Law. However, we also consider it our obligation as a manufacturer to inform you about the following safety information.

Prior to initial start-up

- Observe the "**Installation and Connection Instructions**" in this instruction book.
- If the appliance is delivered in the winter months and temperatures are below freezing: Store the washing machine at room temperature for a few hours before putting it into operation.

Intended Use

- The washing machine is only intended for washing normal domestic washing. If the appliance is used for any other purpose or incorrectly operated, the manufacturer accepts no liability for any damages which may result.
- It is dangerous to alter the specifications or attempt to modify this product in any way.
- Only use detergents which are suitable for automatic washing machines, and follow the recommendations of the detergent manufacturer.
- Garments which have been in contact with flammable solvents should not be washed. Also bear this in mind when washing pre-cleaned washing.
- Do not use the washing machine for dry-cleaning.
- Dyes and bleaching agents may only be used if specifically permitted by the manufacturer of these products. We cannot be held liable for any damages.
- This appliance must be connected to the cold water supply only.
- Damage due to frost is not covered by the guarantee. If the washing machine is located in a room in which below freezing temperatures may occur, emergency emptying must be carried out (see "carrying out an emergency emptying").

Child Safety

- Packaging materials (e.g. films, styrofoam) can be dangerous for children. There is a risk of suffocation! Keep all packaging well away from children.
- This appliance is designed to be operated by adults. Do not allow children to tamper with the controls or play with the appliance.
- Pets and children have been known to climb into washing machines. Please check the drum before use.
- When disposing of the appliance, cut off the mains cable, and destroy the plug. Disable the door lock to prevent young children being trapped inside.

General Safety

- Repairs to washing machines must only be carried out by qualified personnel. Repairs carried out by inexperienced persons may cause injury or serious malfunctioning. Contact your local AEG Service Force Centre.
- Never operate the washing machine if the mains cable is damaged or the control panel, work top or base area are damaged allowing internal components to be accessible.
- Switch off the appliance and isolate from the mains supply before carrying out any cleaning or maintenance work.
- Do not use the mains cable to remove the plug from the socket. Always pull the plug itself.
- Adapters and extension cables must not be used. **There is a danger of overheating!**
- Do not clean the washing machine with a water jet. There is a danger of electric shock!
- During high temperature wash programmes the glass of the door may become hot. Do not touch!
- Allow the water to cool down before cleaning the drain pump, carrying out emergency emptying or opening the door in an emergency.
- Small animals/pets can chew on power cables and water hoses. This can lead to the risk of electric shock and water damage to the appliance and property. Keep small animals away from the appliance.



Disposal

Packaging

Dispose of the packaging material correctly. All packaging materials used are environmentally friendly and can be disposed of without any danger to the environment.

- Plastic parts can be recycled and are identified as follows:
 - >PE< for polyethylene, e.g. the outer covering and the bags in the interior.
 - >PS< for polystyrene, e.g. padding (always CFC-free)
 - >POM< for polyoxymethylene, e.g. plastic clips
- Cardboard packaging is manufactured from recycled paper and should be deposited in the waste paper collection for recycling.

When disposing of the washing machine!

Cut off the mains cable and destroy the plug. Disable the door catch to prevent young children becoming trapped inside. Use an authorised disposal site.



Environmental tips

To save water and energy, and to help protect the environment, we recommend that you follow these tips.

- Do not use a pre-wash for normally soiled washing.
- It is more economical to wash full loads.
- When washing small loads, reduce the detergent by half to two thirds.
- Pre-treat stains, and then wash at a lower temperature.
- Use the energy-saving programme when washing light to normally soiled garments.
- In hard water areas, the use of a water softening agent can reduce the amount of detergent necessary. See manufacturers recommendations.

Description of the Appliance

Front view

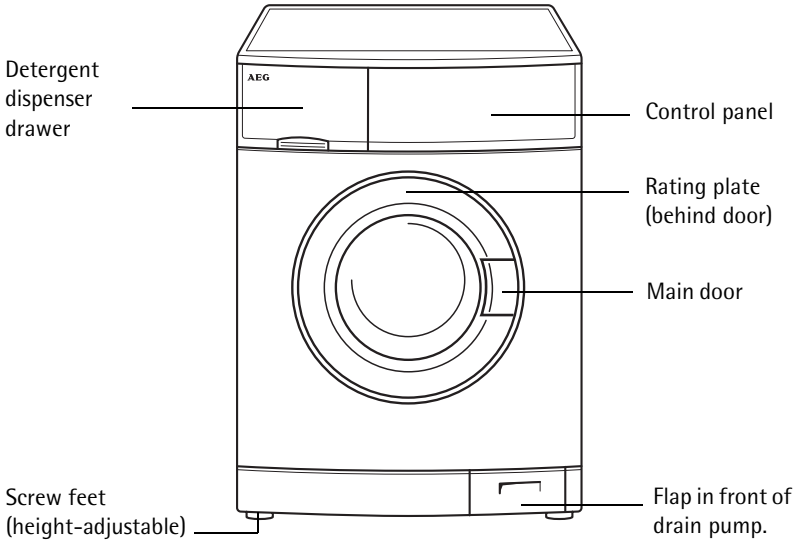

Detergent dispenser drawer

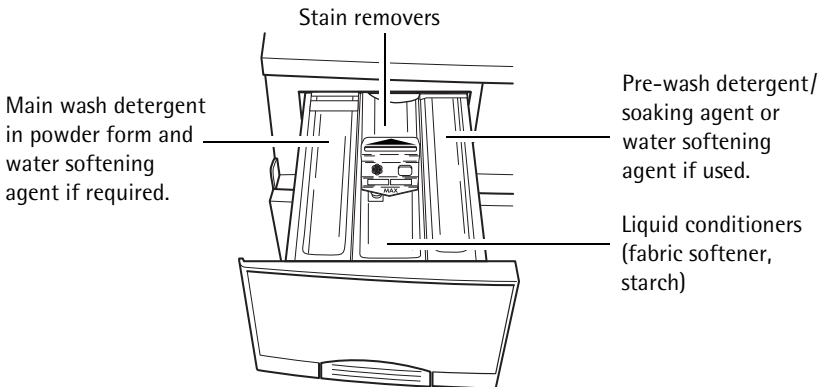

Control panel

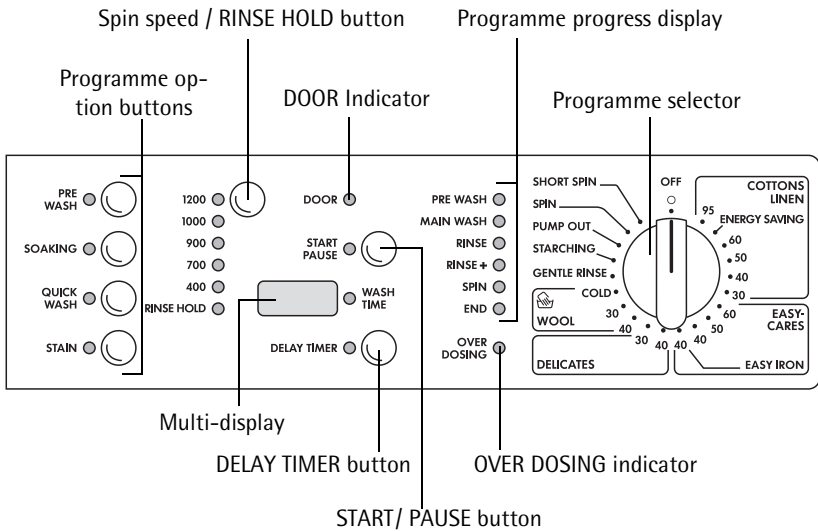

Programme selector

The programme selector defines the nature of the washing cycle (e.g. water level, drum movement, number of rinses, spin speed) to suit the type of washing, as well as the washing solution.

OFF

Switches the washing machine off, the machine is switched on at all other positions.

COTTONS/LINEN

Main washing cycle Cottons / Linen at 30 °C to 95 °C



ENERGY SAVING position: Energy-saving programme at approx. 67 °C for lightly to normally soiled cottons, extended washing time (cannot be combined with QUICK WASH).

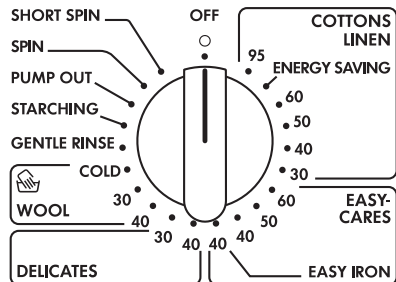

EASY-CARES

Main washing cycle for easy-care textiles (mixed fabrics) at 40 °C to 60 °C.

EASY IRON position: Main washing cycle at 40 °C for easy-care fabrics which, with the aid of this programme, only require a gentle iron, if any ironing at all.

DELICATES

Main washing cycle for delicates at 30 °C or 40 °C.

WOOL  (hand wash)

Main washing cycle (cold to 40 °C) for machine-washable woollens and for woollen fabrics and silk with the care symbol (hand wash).

GENTLE RINSE

Separate gentle rinsing e.g. for rinsing hand-washed fabrics (2 rinsing cycles, liquid conditioner from compartment  is rinsed in, short spin).

STARCHING

Separate starching, separate softening, separate conditioning of wet washing (1 rinse, liquid conditioner is washed in from the compartment , and a spin).

PUMP OUT

Pump out the water at the end of a rinse hold (without spinning).



Rinse hold means the washing remains in the last rinsing water and is not spun.

SPIN

Pumping out the water after a rinse hold and spin, or separate spinning of hand-washed cottons/linen.

SHORT SPIN

Pump out the water at the end of a rinse hold and short spin or separate short spinning for delicate fabrics (easy-cares, delicates, woollens).

Programme option buttons

The programme options buttons are used to adapt the washing program to suit the degree of soiling of the washing. Programme options are not required for normally soiled washing.

The different functions can be combined together depending on the programme.

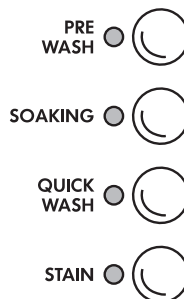

PRE WASH

Warm pre-wash before the main washing cycle which follows on automatically. There is a short spin between the pre-wash and the COTTONS/LINEN main wash. The EASY-CARES and DELICATES main wash follow the pre-wash without a spin.

SOAKING

Approx. 50 minutes at 30°C. Can be extended to a maximum of 10 hours and approx. 20 minutes with the DELAY TIMER button. The main washing programme then follows automatically.

QUICK WASH

Shortened main washing cycle for lightly soiled washing.

STAIN

For treating heavily soiled or stained washing. In-wash stain treatment is washed in from the compartment at the optimal point in the programme cycle. May only be used for wash temperatures from 40°C as stain removers only become effective at higher temperatures.



When the WOOL/ (hand wash) setting is chosen, the programme options cannot be selected (any buttons pressed do not have any effect).

Consumption data and wash times

The values given in the following table for selected programmes were calculated under standard conditions. They provide a useful guide for operation in the home.

Programme selector/ temperature	Load in kg	Water in litres	Energy in kWh	Time in minutes
COTTONS/LINEN 95	5	45	1.70	141
COTTONS/LINEN 60 ¹⁾	5	42	0.94	126
COTTONS/LINEN 40	5	49	0.60	128
EASY-CARES 40	2.5	54	0.50	84
DELICATES 30	2.5	50	0.30	54
WOOL/  (hand wash) 30	2	48	0.20	56

1) **Note:** The selected programme is tested in accordance with EN 60 456. The consumption values, however, can deviate depending on the following: water pressure, water hardness, water inlet temperature, room temperature, washing type and quantity, the detergent used, fluctuations in the mains voltage and the selected programme options.

What does UPDATE mean?

The control system of your machine is fully electronic. The software which determines this control system can be reprogrammed. If a further improvement to washing technology is introduced by AEG then your machine can be updated.

The cost of the update will be advised at the time of the request. For further information regarding this please contact the AEG Customer Care Department.

Before the first wash

-  Run a washing cycle without washing (COTTONS 95, with half the amount of detergent).
This removes any residues from the drum which may have been left during manufacturing.

Preparing a Wash Load

Sorting and preparing a wash load

- Sort washing according to the care symbol and type (see "Washing types and care symbols").
- Empty all pockets.
- Remove metal objects (paper clips, safety pins etc.).
- In order to prevent bunching up of washing and damage to washing, close zippers, button up duvet covers and pillow cases, and tie up loose straps such as from aprons.
- Turn articles with double layered textiles inside out (sleeping bags, anoraks etc.).
- Coloured, knitted fabrics, as well as wool and fabrics with appliqués should be turned inside out.
- Place small and delicate items (e.g. socks, tights and stockings, bras etc.) in a washing net, or pillow case.
- Handle curtains with care. Metal rollers or burred, plastic rollers must be removed or tied into a net or bag. We cannot accept liability for damage.
- Do not wash coloured and white washing together. This could discolour white washing or turn it grey.
- New, coloured washing often contains excessive dye. Wash these separately the first time.
- Mix small and large items of washing. This improves washing efficiency and the washing is more evenly distributed during the spinning cycle.
- Shake out washing before placing into the washing machine.
- Do not place folded washing into the drum.
- Observe tips such as "wash separately" and "wash separately several times".

Washing Types and Care Symbols

The care symbols help you choose the correct washing programme. Washing should be sorted according to type and care symbol. The temperatures indicated in the care symbols are the maximum temperatures.

Cottons

Fabrics made from cotton and linen with this care symbol will withstand maximum wash actions and high temperatures. The COTTONS / LINEN programme is appropriate for this type of washing.

Linens

Fabrics made of cotton and linen which carry this care symbol will withstand maximum wash actions. The COTTONS / LINEN programme is appropriate for this type of washing.

Easy-cares

Fabrics such as treated cotton, cotton mixed fabrics, viscose and synthetics which carry this care symbol need a softer wash action. The EASY CARES / EASY IRON programme is appropriate for this type of washing.

Delicates

Fabrics such as those with layered fibres, micro fibres, viscose, synthetics, as well as curtains with this care symbol require particularly careful handling. The DELICATES programme is appropriate for this type of washing.

Wool and particularly sensitive washing

Fabrics such as wool, wool mixtures and silk with this care symbol require a very gentle wash cycle. The WOOL /  (hand wash) programme is suitable for this type of washing.

Important! Fabrics with this care symbol  (do not wash!) must not be washed in washing machines.

Detergents and Conditioners

Which detergent and conditioner?

Use only detergents and conditioners which are suitable for use in automatic washing machines. Always follow the manufacturer's instructions.

How much detergent and conditioner?

The required quantity depends upon:

- the extent of soiling of the washing
- the hardness class of the mains water
- the amount of washing



Should the detergent manufacturer not specify the dosage quantity for less than full loads, reduce the detergent accordingly: For a half load reduce the quantity by 1/3. For a small load or an EASY IRON programme reduce the quantity by 1/2.

Observe the instructions for use and dosing provided by the detergent and conditioner manufacturer.

Water softening

For medium to high water hardness (hardness class II upwards) a water softening agent can be used. Refer to the manufacturer's instructions. Then always add the appropriate amount of detergent (underdosing) for hardness class I (soft). Your local Water Authority can advise you on the hardness of the water in your area.

Water hardness details

Hardness class	Water hardness in °dH (German hardness scale)	Water hardness in ppm (Parts Per Million)
I - soft	0 - 7	to 125
II - medium hard	7 - 14	125 - 250
III - hard	14 - 21	250 - 375
IV - very hard	greater than 21	greater than 375

Running a washing cycle

Brief instructions

A washing cycle consists of the following steps:

1. Set the correct washing programme:
 - Select the programme and temperature with the programme selector.
 - Select any programme options if required.
2. If necessary, change the spin speed/select RINSE HOLD.
3. Set the DELAY TIMER if required.
4. Open the door and load the washing.
5. Close the door.
6. Add the detergent/conditioner.
7. Start the washing programme with the START/PAUSE button.

When the washing programme has ended:

Important! If the washing cycle ended with a rinse hold, carry out PUMP OUT, SPIN, or SHORT SPIN before opening the door.

8. Open the door and remove the washing.
9. Switch off the washing machine: Set the programmes selector to OFF.

Setting the Washing Programme

i See "Programme tables" for a suitable programme, correct temperature and possible programme options to suit the type of washing.

- 1.** Set the programme selector to the desired washing programme with the desired temperature. The expected duration of the programme selected is displayed in the multi display in minutes.

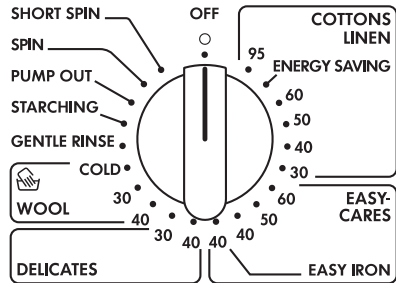

- 2.** If required, select programme option(s):

The indicator of the programme selected lights up.

- To change the selection press another button.
- To cancel a selection, press the button again.



Changing the spin speed/Selecting Rinse Hold

- 1.** If necessary, change the spin speed for the final spin/select RINSE HOLD:

Press the Spin speed/RINSE HOLD button repeatedly until the indicator of the required spin speed or of RINSE HOLD illuminates.

If RINSE HOLD is selected, the washing remains in the final rinse water. It is not spun.



i If you do not change the spin speed, the final spin is automatically adjusted to suit the washing programme.

- COTTONS/LINEN 1200 revolutions per minute
- EASY CARES / EASY IRON 900 revolutions per minute
- DELICATES 700 revolutions per minute
- WOOLLENS/ (hand wash) 900 revolutions per minute

The speed of the intermediate spin is dependent on the selected programme and cannot be changed.

Setting the delay timer / soaking duration

Delay timer

The DELAY TIMER button allows the start of a washing programme to be delayed by 1 hour up to a maximum of 19 hours.



To do this, press the DELAY TIMER button repeatedly until the desired start delay is shown in the multi display, for example **12h** for a 12 hour delay.

If **19h** is displayed and you press again, **0h** appears, followed by the duration time of the set programme (displayed in minutes e. g. **126**). In this state the start delay timer is not set.

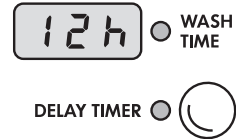

Soaking duration

When the SOAKING button is pressed, you can extend the soaking period with the DELAY TIMER button (maximum 10 hours and approx. 20 minutes).



Without DELAY TIMER, the soaking period is approximately 30 minutes, plus a pre-wash time of 20 minutes.



To adjust, press the DELAY TIMER button as often as necessary until the required soaking period is shown in the multi display, e.g. **1h** (=1 hour).

After approximately 2 seconds, the multi display shows the duration in minutes.



This duration time is made up as follows:

Selected soaking period	e.g.	1h =60 Minutes
+ Heating-up / pre-wash time	e.g.	Approx. 20 Minutes
+ Duration of the selected wash programme	e.g.	Approx. 126 Minutes
= Displayed value	e.g.	Approx. 206 Minutes



While SOAKING is running, PRE-WASH lights up on the programme progress display.

Opening and closing the door

 Open: Pull the handle on the door.

DOOR 

 Close: Press the door firmly closed.

The displays DOOR and START/PAUSE show when the appliance is switched on whether the door can be opened:

START
PAUSE 

DOOR Indicator	Display START/PAUSE	Door opening possible?
lights up green	flashes red	yes
lights up green	lights up red	yes, after the START/PAUSE key is pressed
is off	flashes red or lights up red	no ¹⁾

1) The door is locked because of a high water level or high temperature



If

- the display DOOR flashes red,
 - then the error code **E40** flashes in the multi display,
 - and the MAIN WASH display flashes,
- an attempt was made to start a washing programme without the door being correctly closed. In this case, press the door firmly closed and start the washing programme again.

Loading the washing



See "Programme Tables" for maximum loads.

For information about the correct preparation of the washing see "Sort and prepare washing".



1. Sort and prepare the washing according to type.

2. Open the door: Pull the handle on the door.

3. Load the washing.

Important! Do not trap washing when closing the door. The fabrics and the machine could be damaged.

4. Close the door firmly.

Add detergent / conditioner

i For instructions concerning detergent and conditioners, see "Detergents and conditioners".

1. Open the detergent dispenser drawer. press in the flap on the drawer so as to be able to grasp the handle(1), and pull out the drawer (2).

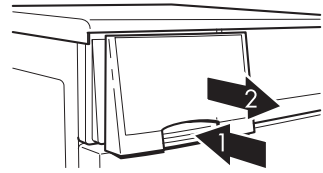

2. Adding detergent / conditioner

Compartment for in-wash stain treatment

Compartment for powder main detergent

(If you use water softening agent and require the right compartment for the pre-wash/soaking detergent , add the water softening agent to the main detergent in the left compartment.)

Compartment for liquid conditioner

(Softener, finisher, starch)

Important! Do not fill above the MAX mark. When using thick concentrated fabric conditioners and starches we recommend you dilute the concentrate with water to ensure trouble-free dispensing. If using starch powder dissolve according to the manufacturer's instructions.

Note: It is normal for a small amount of water to be left in the compartment for liquid conditioner; this will not affect the wash results.

Compartment for pre-wash/soaking detergent
(Only for programme options PRE-WASH/SOAKING)
or for water softening agent

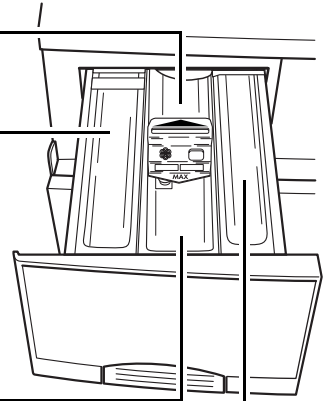

3. Push the detergent dispenser drawer fully in.

i **If using liquid detergent / tablets**

Add liquid detergent / tablets in the quantity recommended by the washing detergent manufacturer. Add liquid detergent with dosage containers provided by the detergent manufacturer.

Starting the washing programme

1. Check that the water tap is open.
2. Start the washing programme:
Press the **START/PAUSE** button
The washing programme is started or starts at the end of the time delay set.



- i** If the **DOOR** display flashes red when the **START/PAUSE** button is pressed, the door is not properly closed.
- The display **DOOR** flashes red
 - The error code **E40** then flashes in the multi display
 - And the **MAIN WASH** display flashes.
- In this case, press the door firmly closed and again press the **START / PAUSE** button.

If the delay timer has been set:

The start time delay set on the time delay counts down; the time remaining until the programme starts is displayed in the multi-display (in hours remaining, e.g. **5h**). During this time you can add washing and change or stop the delay timer.

- Load the washing: Press the **START/PAUSE** button. The door can be opened. Then close the door and press the **START/PAUSE** button again.
- Changing or stopping delay timer: Press the **DELAY TIMER** button repeatedly until the desired time is displayed. When the programme duration is displayed (display in minutes e. g. **126**) the washing programme starts without delay.

Washing Programme Progress

Programme progress display

Prior to the start, the programme steps chosen are displayed by the Programme progress display. During the washing programme the current programme step is displayed.



Multi-display

The expected time remaining (in minutes) to the end of the programme is displayed in the multi display.



- i** The counting down of the remaining time may be stopped or corrected by the washing machine controller as a result of automatic adjustments to the programme (amount of washing, washing type, imbalance detection, special rinse cycle, etc.).

Change the washing programme

Changing or stopping the wash programme

-  1. Press the START/PAUSE button.
2. Turn the programme selector to OFF. The washing programme is stopped.
3. If required, set a new washing programme. Otherwise, turn the programme selector to PUMP OUT and press the START/PAUSE button.

- i** The washing programme can be interrupted at any time with the START/PAUSE button and can be continued by pressing the button again. Changing the washing programme is only possible after the programme selector has been turned to OFF.

Selecting the programme options.

The programme options QUICK WASH or STAIN can still be selected after the programme starts.

-  1. Press the START/PAUSE button.
2. Press the QUICK WASH or STAIN button.
3. Press the START/PAUSE button again. The washing programme is continued.

Changing the Spin Speed

During the washing programme, the spin speed can still be changed or RINSE HOLD can be set.

-  1. Press the START/PAUSE button.
2. Change the speed with the Spin speed / RINSE HOLD button.
3. Press the START/PAUSE button again. The washing programme continues.

Washing cycle is complete/Removing the washing.

Once the washing programme has come to an end, END illuminates on the programme progress display.

If RINSE HOLD was selected, the display beside the START/PAUSE button flashes.

-  **1.** After a rinse hold, the water must first be pumped out:
- Either press the START/PAUSE button (the water is pumped out and the washing is spun according to the completed programme; After the START/PAUSE button is pressed again, the spin speed can still also be changed during spinning),
or
 - Turn the programme selector to PUMP OUT and press the START/PAUSE button (the water is pumped out without spinning),
or
 - Turn the programme selector to SPIN or SHORT SPIN and press the START/PAUSE button (the water is pumped out and the washing is spun or gently spun).

At the end of this programme step, the END indicator will illuminate.

2. Open the door.

As soon as the DOOR indicator lights up green, the door can be opened.

3. Remove the washing.

4. Turn the programme selector to OFF.

5. Close the water tap.

6. After washing, pull out the washing detergent dispenser drawer slightly so that it can dry out. Leave the door ajar so that air can circulate in the drum.



If the OVERDOSING indicator illuminates, then too much detergent was used in the washing programme just completed. Observe the dosing recommendations of the detergent manufacturer as well as the load quantity for the next wash.













Important! If the washing machine is not to be used for a long period: Close the water tap and disconnect the washing machine from the electricity mains.

Programme tables

Washing

Not all possible settings are listed below, only those which are useful and meaningful in everyday use.

Type of washing; care symbol	Max. load (dry weight) ¹⁾	Programme selector; temperature	Possible programme op- tions
Cottons 	5 kg	COTTONS/LINEN 95	PRE WASH SOAKING QUICK WASH STAIN
Energy-saving programme: Cottons 	5 kg	COTTONS/LINEN ENERGY SAVING	PRE WASH SOAKING STAIN
Linen  	5 kg	COTTONS/LINEN 30 to 60	PRE WASH SOAKING QUICK WASH STAIN ²⁾
Easy-cares  	2.5 kg	EASY-CARES 40 to 60	PRE WASH SOAKING QUICK WASH STAIN
	1 kg	EASY IRON ³⁾ 40	
Delicates 	2,5 kg (or 15-20m ² curtains)	DELICATES 30, 40	PRE WASH SOAKING QUICK WASH STAIN ²⁾
Woollens/Hand Wash   	2 kg	 WOOL COLD up to 40	

1) A 10 litre bucket holds approximately 2.5kg of dry washing (cotton).

2) In the case of the STAINS, a minimum temperature of 40°C is required for the stain remover to become effective.

3) Creases in the washing are largely prevented only by maintaining the load quantity of 1 kg.

5 to 7 easy-care men's shirts are equivalent to approximately 1 kg of dry washing.

This machine is capable of washing 5.5 kg, however, to achieve optimum wash results it is recommended that the wash loads quoted in this instruction book are adhered to.

Separate conditioning/starching

Type of washing	Max. Load (dry weight)	Programme selector
Cottons/linen	5 kg	STARCHING

Separate rinse

Type of washing	Max. Load (dry weight)	Programme selector
Cottons/linen	5 kg	GENTLE RINSE
Easy-cares	2.5 kg	
Delicates	2.5 kg	
Woollens/Hand Wash	2 kg	

Separate spin

Type of washing	Max. Load (dry weight)	Programme selector
Cottons/linen	5 kg	SPIN
Easy-cares	2.5 kg	SHORT SPIN
Delicates	2.5 kg	
Woollens/Hand Wash	2 kg	

Maintenance and Cleaning

Control panel

Important! Do not use household furniture polish or abrasive cleaners to clean panel and operating parts.

- ☞ Wipe over the operating panels with a damp cloth. Use warm water.

Detergent Dispenser Drawer

The detergent dispenser drawer should be cleaned from time to time.

- ☞ 1. Pull the detergent dispenser drawer out as far as it will go.
- 2. Remove the detergent dispenser drawer by pulling sharply.
- 3. Take the conditioner insert out of the middle compartment.
- 4. Clean the conditioner insert under running water.

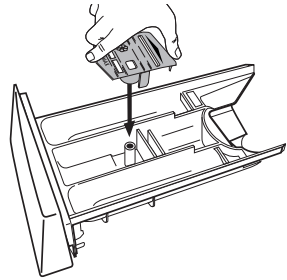

- 5. Clean the separate compartments with warm water. It is best to use a flat brush.

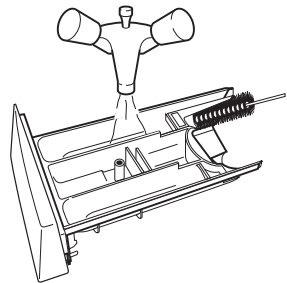

- 6. Push on the conditioner insert as far as it will go so that it is securely in place.

7. Use a brush to clean the entire compartment area of the washing machine, particularly also the nozzles on the top side of the compartment.

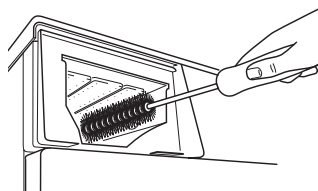

8. Set the detergent dispensing drawer into the guide tracks and push it in.

Washing Machine Drum

The washing machine drum is made from rust-free stainless steel. Any objects left in the laundry which are likely to rust can stain the drum.

Important! Do not clean the stainless steel drum with descaling agents containing acids, scouring agents containing chlorine or iron, or steel wool. Your local AEG Service Force Centre has suitable agents available.

- ☞ Remove any rust stains on the drum using a stainless steel cleaning agent.

Maintenance Wash

- 📘 With the use of low temperature washes it is possible to get a build up of residues inside the drum. We recommend that a maintenance wash be performed on a regular basis.

To run a maintenance wash:

The drum should be empty of laundry.

- ☞ 1. Select the hottest cotton wash programme.
- 2. Use a normal measure of detergent, must be a powder.

Main door

- ☞ Regularly check to see if there are deposits or foreign objects in the rubber seal behind the door, and remove them.

Cleaning the drain pump

Paper clips, nails and so on can sometimes get into the washing machine with the washing and remain in the drain pump casing. Fluff and strands of fabric can gather on these items and block the drain pump. Therefore the drain pump should be cleaned at least once a year.



Warning! Switch off the washing machine and pull out the mains plug before cleaning the drain pump.

1. First carry out emergency emptying (see section "Carrying out emergency emptying").
2. Place a towel on the floor in front of the cover of the drain pump. Surplus water may flow out.
3. Unscrew the drain pump cover anti-clockwise and pull it out.

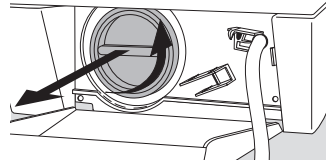

4. Remove any foreign bodies from the pump housing.

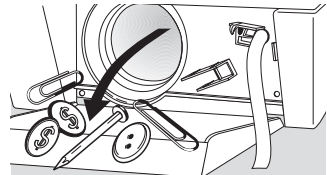

5. Replace the cover. Insert the webs on the cover laterally into the guide slots and screw on the cover securely clockwise.

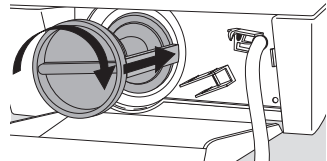

6. Close the emergency emptying hose and place it in the holder.
7. Close the flap.

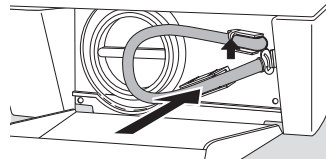

What to do if...

Trouble Shooting

If the appliance is not working correctly, please carry out the following checks before contacting your local AEG Service Force Centre.

Important: If you call out an engineer to a fault listed below, or to repair a fault caused by incorrect use or installation, a charge will be made even if the appliance is in guarantee.

- If the fault code **E 10**, **E20** or **E40** is shown in the multi-display, you may be able to remedy the fault yourself (see the Faults table below).



After clearing the fault, press the START/PAUSE button. If the fault code is displayed again, contact your local AEG Service Force Centre.

- For all other faults displayed in the multi-display, please contact your local AEG Service Force Centre, stating the fault code.

Problem	Possible Cause	Remedy
The washing machine does not work.	The mains plug is not plugged in.	Plug in the mains plug.
	The house fuse has blown.	Replace the fuse.
	The door is not correctly closed.	Close the door; The lock must engage audibly.
	START/PAUSE button not pressed long enough.	Keep the START/PAUSE button pressed until the programme begins.
Door cannot be closed.	The child safety feature is set	Cancel the child safety feature (see Section "Child Safety Feature").
The fault code E40 appears. The display MAIN WASH flashes.	The door is not correctly closed.	Close the door correctly. Start the programme again.

Problem	Possible Cause	Remedy
<p>No water flows. Fault code E 10 appears. The display RINSE + flashes</p>	<p>Water tap is closed.</p>	<p>Open the water tap.</p>
	<p>Filter in screw connection of the inlet hose is blocked.</p>	<p>Close the water tap. Unscrew the hose from the tap, remove the filter and clean under running water</p>
	<p>Water tap is blocked with limescale or is faulty.</p>	<p>Check the water tap and have it repaired if necessary.</p>
<p>The washing machine vibrates during operation or is unstable.</p>	<p>The transport packaging has not been removed.</p>	<p>Remove transport packaging according to the installation and connection instructions.</p>
	<p>The machine is not level.</p>	<p>Adjust the feet according to the installation and connection instructions.</p>
	<p>There is very little washing in the drum (e.g. only one dressing gown).</p>	<p>This does not impair the operation of the machine.</p>
	<p>The water could not be completely pumped out before spinning because the drainage hose is kinked or the drain pump is blocked.</p>	<p>Check the the drain hose and remove any kink if necessary, or clean the drain pump and, if required, remove foreign bodies from the pump housing.</p>
<p>Excessive foaming during the main wash.</p>	<p>Probably too much detergent was used.</p>	<p>It may be necessary to reduce the amount of detergent used. Follow the detergent manufacturer's recommendations.</p>

Problem	Possible Cause	Remedy
Water runs out from under the washing machine.	The screw connection on the inlet hose is leaking.	Tighten the inlet hose screw connection
	The drainage hose is leaking.	Check the drainage hose and replace it if necessary.
	The washing drain pump cover is not correctly closed.	Close cover correctly.
	Washing is caught in the door.	Stop the programme and remove the washing caught in the door. Restart the programme.
	The emergency emptying hose is not correctly closed or is leaking.	Close the emergency emptying hose correctly (see the section "Carrying out Emergency Emptying"). Call your local Service Force Centre if the emergency emptying hose leaks.
Fabric softener was not washed in, compartment  for conditioners is filled with water.	The conditioner insert in the compartment for the conditioners is not correctly attached or is blocked.	Clean the detergent dispenser drawer and attach the conditioner insert securely.
Washing heavily creased	Probably too much washing put in the drum.	Pay attention to the maximum load quantity (see Programme tables). In the case of easy-care fabrics, select the EASY IRON programme.
The washing is not sufficiently spun. Water is left in the drum. The fault code E20 appears. The RINSE display flashes.	Drain hose is kinked.	Remove the kink.
	Maximum pump head (discharge height 1 m from the appliance's base) is exceeded.	Contact your local Service Force Centre. For pumping heights over 1 m a conversion kit is available as a special accessory.
	Drain pump is blocked.	Switch off the appliance and pull out the mains plug. Clean the drain pump.

Problem	Possible Cause	Remedy
<p>The door cannot be opened when the appliance is switched on.</p>	<p>The door is locked due to a high water level or a high temperature. (the DOOR display is off).</p>	<p>Wait until the DOOR display lights up green.</p> <p>If it is still necessary to open the door: turn the programme selector to OFF turn the programme selector to PUMP OUT. Press the START/PAUSE button After the water has been pumped out, the door can be opened.</p>
	<p>Power failure! (All displays have gone off.) For safety reasons the door remains locked for 4 to 5 minutes.</p>	<p>If water can be seen through the window in the door, first carry out emergency emptying (see section "Carrying out Emergency Emptying Operation"). After approx. 4 to 5 minutes the door can be opened again by pulling the handle.</p>
<p>Remnants of detergent are building up in the detergent dispenser drawer.</p>	<p>Water tap is not fully opened.</p>	<p>Open the water tap fully.</p>
	<p>The inlet hose filter in the coupling inlet hose at the tap is blocked.</p>	<p>Close the water tap. Unscrew the inlet hose from the water tap and from the appliance. Clean the filter.</p>
<p>The rinsing water is cloudy.</p>	<p>The cause is probably a detergent with a high silicate content.</p>	<p>No negative effect on the rinsing results, use a liquid detergent if necessary.</p>
<p>When pressing a programme option button the corresponding display does not light up.</p>	<p>The selected programme option cannot be combined with the set programme.</p>	<p>Make another selection.</p>

If the washing results are not satisfactory

If the washing turns greyish and limescale deposits are present in the drum

- Insufficient detergent has been added.
- Incorrect detergent was used.
- Stains were not pre-treated.
- Programme or temperature was not set correctly.
- If using modular detergents, the individual components were not used in the correct ratio.

If there are still grey stains on the washing

- Soiled garments with ointments, grease or oils were washed with insufficient detergent.
- The temperature selected for the wash was too low.
- A frequent cause is that fabric softener - particularly a concentrated one - has come into contact with the washing. Wash out these types of stains as soon as possible and use the fabric softener carefully.

If after the last rinse foam is still visible

- Modern detergents can still cause foam in the final rinse cycle. However, the washing is still sufficiently rinsed.

If there are white residues on the washing

- These are insoluble contents of modern detergents. They are not the result of an insufficient rinse. Shake out the washing or brush it off. Turn the washing inside out before washing it. Review your choice of detergent and if necessary use liquid detergent.

Carrying out an emergency emptying

- If the washing machine no longer pumps out the water, emergency emptying must be carried out.
- If the washing machine is located in a room in which below freezing temperatures might occur, emergency emptying must be carried out. Furthermore: unscrew the inlet hose from the water tap and drain off the water. Empty the drainage hose.



Warning! Switch off the washing machine and pull out the mains plug prior to performing emergency emptying.

Warning! The water, which flows out of the emergency emptying hose can be hot. First allow the water to cool down before you carry out the emergency emptying.

1. Have a flat container on hand to catch the water.
2. Pull down the flap in the right corner of the base strip outwards and pull it off.

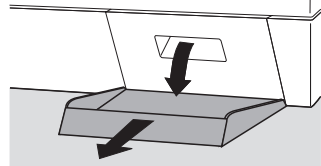

3. Remove the emergency emptying hose from its holder.

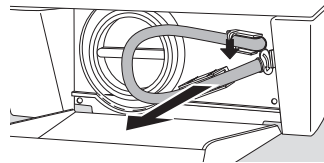

4. Place the container under the hose.
5. Detach the plug of the emergency emptying hose by turning it anticlockwise and pull it out.

The water runs out. Depending on the amount of water, it may be necessary to empty the collecting vessel several times. To do this, close the emergency emptying hose temporarily with the plug.

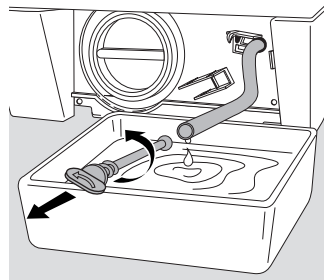

Discard the water from the container, replace it under the emergency emptying hose and remove the plug from the hose.

When the water is completely drained:

6. Push the plug securely into the emergency emptying hose and turn it clockwise to secure it.
7. Replace the emergency emptying hose in its holder.
8. Put on the flap and close.

Additional Rinse (RINSE+)

The washing machine is set for very economical water consumption. However, for persons who suffer from allergies to detergents, it can be helpful to rinse with extra water.



If RINSE+ is set, an additional rinse is carried out with the COTTONS/LINEN, EASY CARES/EASY IRON and DELICATES programmes. When the appliance is supplied from the factory, the additional rinse function is not set.

Setting the additional rinse function:



1. Turn the programme selector to COTTONS/LINEN, EASY CARES/EASY IRONS or DELICATES (with any temperature).
2. Keep the PRE WASH and QUICK WASH buttons pressed simultaneously for at least 2 seconds. RINSE+ lights up on the programme progress display. The additional rinse is set. It remains set until it is manually cancelled.



The additional rinse increases water consumption and the programme duration time.

Cancelling the additional rinse function:



1. Again turn the programme selector to COTTONS/LINEN, EASY CARES/EASY IRON or DELICATES.
2. Keep the PRE WASH and QUICK WASH buttons pressed simultaneously for at least 2 seconds. RINSE+ goes out on the programme progress display. The additional rinse is cancelled.

Child Safety Feature

If the child safety feature is set, the door cannot be closed and no washing programme can be started.

Setting the child safety feature



Use a coin to turn the rotary knob on the inside of the door clockwise as far as it will go.

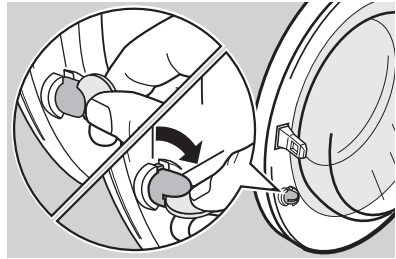

Warning! The rotary knob must not be in a vertical position after adjustment, otherwise the child safety feature is not active. The rotary knob must project as shown in the diagram.

Cancelling the child safety feature



Turn the rotary knob anticlockwise as far as it will go.

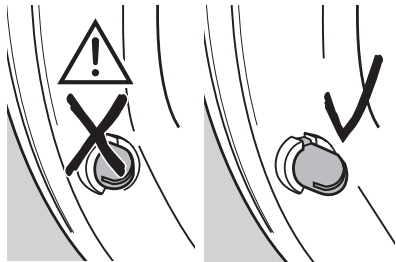

Installation and connection instructions

Installation Safety Precautions

- When moving do not tilt the washing machine onto its front or onto its right hand side (viewed from the front). This is to prevent the possibility of the electronic components becoming wet.
- Before installation inspect the machine for transport damage. Do not connect the appliance if it is damaged - contact your retailer.
- Ensure all packaging and transit bolts/bars have been removed, see „Removal of Transit Packaging“. Failure to remove transit bolts/bars may cause serious damage to the appliance or property.
- Always insert the plug into a correctly installed earthed socket.
- Any plumbing work required to install this appliance should be carried out by a plumber or competent person.
- Check that the electricity supply is the same as that indicated on the appliance's rating plate.
- Any electrical work required to install this appliance should be carried out by an electrician or competent person.

Installation of the appliance

Transporting the appliance

- Do not place the washing machine on its front or on its right hand side (viewed from the front). This is to prevent the possibility of the electronic components becoming wet.
- Never transport the unit without the transport packaging and bolts/bars. Do not remove the transport packaging until the appliance is at the installation location. Transporting the unit without the transport packaging can damage it.
- Never lift the appliance by the door.
- When transporting the unit with a sack trolley: Attach the sack trolley at the side only.

Remove transport packaging

Important! It is essential to remove the transport packaging before putting the appliance into operation. Keep all parts of the transport packaging in a safe place for future use.

1. Open both hose holders on the appliance's rear side and remove the hoses and mains cable.

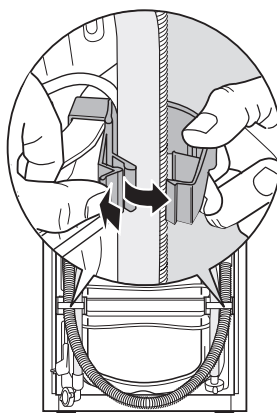

2. Pull both hose holders off the appliance with a strong pull.

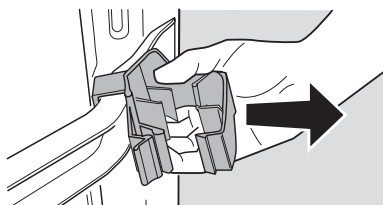

i The special spanner (E) and the caps (D) (2 each) and (G) (1 each) are supplied with it.

3. Remove the two screws (A) with the special spanner.
4. Remove the 4 screws (B).
5. Remove the transit bar (C).
6. Screw the 4 screws (B) back in for safe keeping.
7. Close the 2 large holes with the caps (D).

Important! When fitting the plastic caps, press until they snap into the rear panel securely.

8. Remove the screw F, including the compression spring with the special spanner E.
9. Cover the hole with the cap G.

Important! When fitting the plastic caps, press until they snap into the rear panel securely.

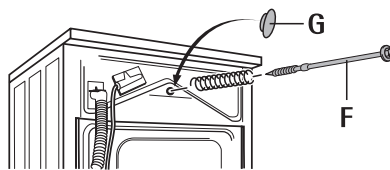
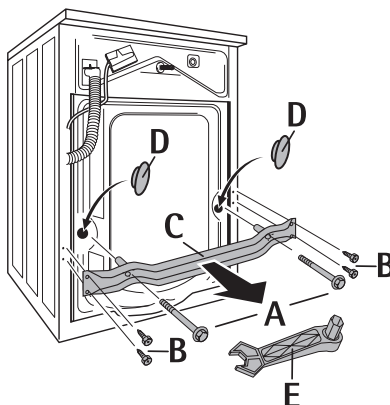

Installation-Site preparation

- The installation surface must be clean, dry and level. Do not install on a deep pile carpet.
- Minor unevenness of the floor surface should never be levelled out by laying pieces of wood, card or similar materials, but should always be compensated for by adjusting the screw feet.
- If the appliance is installed next to a heat source (e.g. cooking appliance), a heat insulating pad (87 x 57 cm) must be placed between the appliance and the heat source.
- Do not install the appliance in locations where the temperature may fall below freezing.
- Please ensure that when the appliance is installed it is easily accessible for the engineer in the event of a breakdown.

Installation on a Suspended Floor

Suspended wooden floors are particularly susceptible to vibration. To help prevent vibration we recommend you place a waterproof wood panel, at least 15 mm thick under the appliance, secured to at least 2 floor beams with screws. If possible install the appliance in one of the corners of the room, where the floor is more stable.

Levelling the Appliance

Floor unevenness can be compensated for and the height can be corrected with the four adjustable screw feet. The height can be adjusted in a range of +10 ... -5 mm.

To adjust the feet use the special spanner supplied.

1. Slide the special key firmly onto the hexagon head of the threaded foot as far as it will go.
2. Adjust the screw feet so that the appliance is horizontal and stable.
3. Check that the appliance is level using a spirit level.

Important. Never use strips or shims of wood or cardboard etc. To compensate for any unevenness in the floor. Always use the adjustable feet.

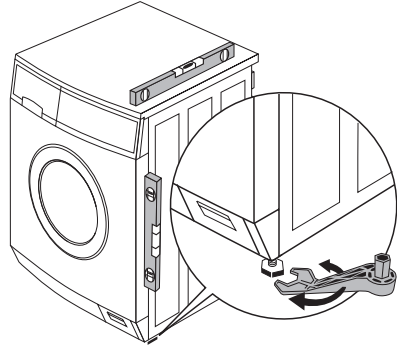

Electrical Connection

Any electrical work required to install this appliance should be carried out by a qualified electrician or competent person.



WARNING - THIS APPLIANCE MUST BE EARTHED.

The manufacturer declines any liability should these safety measures not be observed.

Before switching on, make sure the electricity supply voltage is the same as that indicated on the appliance rating plate.

The rating plate is located at the top of the rim of the open door.

The appliance is supplied with a 13amp plug fitted. In the event of having to change the fuse in the plug supplied, a 13amp ASTA approved (BS 1362) fuse must be used.

Should the plug need to be replaced for any reason, proceed as described below.

The wires in the mains lead are coloured in accordance with the following code:

Green and Yellow:	Earth
Blue:	Neutral
Brown:	Live

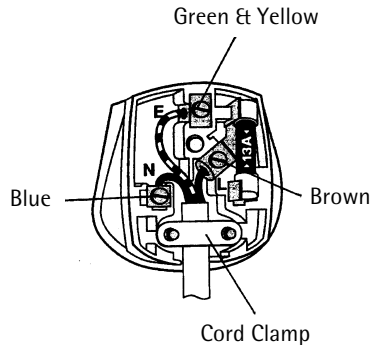
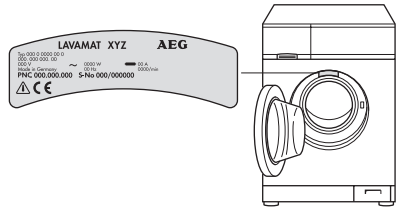

- The wire coloured green and yellow must be connected to the terminal marked with the letter "E" or by the earth symbol \oplus or coloured green and yellow.
- The wire coloured blue must be connected to the terminal "N" or coloured black.
- The wire coloured brown must be connected to the terminal marked "L" or coloured red.
- Upon completion there must be no cut, or stray strands of wire present and the cord clamp must be secure over the outer sheath.



WARNING! A cut off plug inserted into a 13 amp socket is a serious safety (shock) hazard. Ensure that the cut off plug is disposed of safely.

Permanent Connection

In the case of a permanent connection it is necessary that you install a double pole switch between the appliance and the electricity supply (mains), with a minimum gap of 3 mm between the switch contacts and of a type suitable for the required load in compliance with the current electrical regulations.

The switch must not break the yellow and green earth cable at any point.



This appliance is in accordance with the following EU Guidelines:

- Low Voltage Guidelines 73/23 EEC dated 19 February 1973, include Guideline Change Notice 93/68 EEC
- EMC Guideline 89/336 EEC dated 3 May 1989, including Guideline Change Notice 92/31 EEC.

This appliance complies with the requirements laid out in the EEC Directive 76/899.

Voltage 240 V AC: Fuse rating 13 amps

See rating plate for further information.

This appliance meets VDE requirements.

Particular regulations of local electricity authorities must be observed. This appliance conforms to EEC Directive No. 82/499/EWG on radio interference.



WARNING! Repairs to electrical appliances must only be carried out by trained personnel. Improper repairs may lead to serious risks for the user.

Water connection



The washing machine is provided with safety devices preventing back-contamination of the water supply and complies with local water authority requirements.

This appliance is designed to be permanently plumbed into your home's water supply.

Before connecting up the machine to new pipework or to pipework that has not been used for some time, run off a reasonable amount of water to flush out any debris that may have collected in the pipes.

Important!

- Appliances for connecting to cold water must not be connected to hot water.
- Only use new hose sets for the connection.

Water pressure

The appliance is designed to operate within the following water pressure units. Minimum 1 bar (= $10\text{N/cm}^2 = 0.1\text{ Mpa}$), maximum 10 bar (= $100\text{N/cm}^2 = 1\text{ Mpa}$).

- If more than 10 bar: Install a pressure-reduction valve upstream
- If less than 1 bar: Unscrew the inlet hose from the appliance at the inlet solenoid valve and remove the flow regulator (to do this, remove the filter with needle nose pliers and remove the rubber washer behind the filter). Replace the filter.

Inlet Hose Connection

A pressure hose of 1.35m in length is supplied.

If a longer inflow hose is required, only a VDE-approved, complete set of hoses with fitted hose screw connections is permissible, available from AEG Service Force Centres.

- Hose sets in lengths of 2.2m, 3.5m, and 5m are available for washing machines without Aqua-Control.
- Hose sets in lengths of 2.0m, 2.9m and 3.9m are available for washing machines with Aqua-Control.

Important! Never cut into pieces in order to extend the hoses!



Sealing rings are supplied either in the plastic nuts of the hose screw connection or in the enclosed pack. Do not use other seals!



1. Connect the hose with the angled connection to the machine.

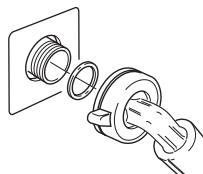

Important!

- Do not lay the inlet hose vertically downwards, instead run it to the right or left as shown in the diagram.
- Tighten firmly to prevent leakage but do not use excessive force.

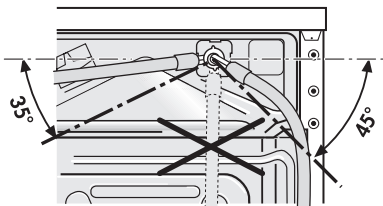

2. Connect the hose with the straight connection to a water tap with a screw thread R 3/4 (inches)

Important! Only tighten the screw connection by hand.

3. By slowly opening the water tap before putting the washing machine into operation, check that the connection is free of leaks.

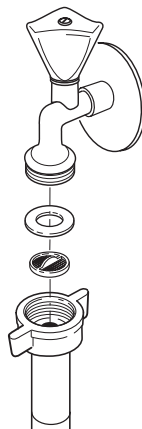

Water Drainage

The appliance drain hose should hook into a standpipe, the hook in the drain hose is formed using the plastic "U-Piece" supplied. The standpipe should have an internal diameter of approximately 38 mm (see diagram) thus ensuring there is an air break between the drain hose and standpipe.

Important! It is essential to lay the drainage hose without kinks.

When discharging into a standpipe ensure that the top of the curve in the hose end is no more than 90 cm (35.4") and no less than 60 cm (23.6") above floor level.

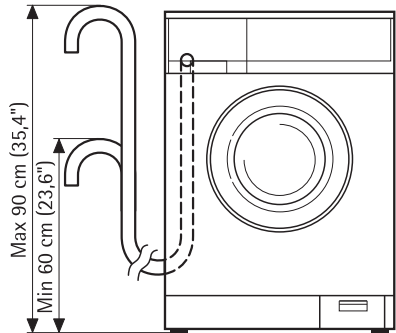

The upright standpipe should have a minimum length of 30 cm (12") from the bottom of the elbow to the top of the pipe (see diagram). Make sure that it is designed in such a way that the end of the drain hose cannot be covered with water.

Longer drain hoses are available in lengths of 2.7 and 4 metres from your AEG Service Force Centre.

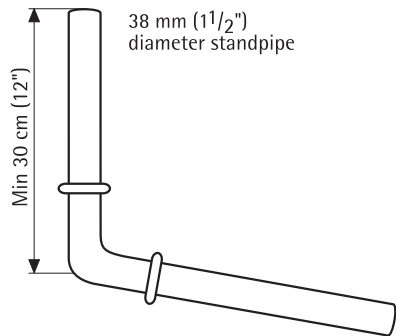

If you intend the drain hose from the washing machine to empty into a sink, make sure that the sink is empty and the plug hose is not blocked. Use the plastic "U-Piece" supplied.

Important! The end of the drainage hose must not be submerged in the pumped-out water. Otherwise, the water could be sucked back into the appliance.

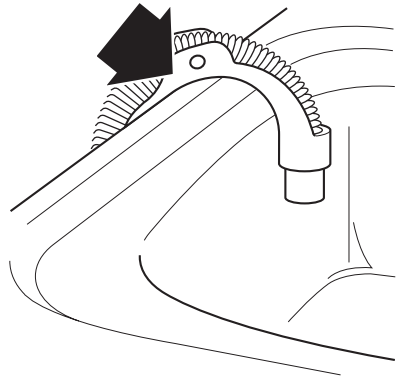

Pump head of greater than 1m

Every washing machine includes a wash water pump for the removal of wash and rinse water, which can pump fluids through the outlet hose up to a height of 1m, measured from the surface on which the machine stands.

For pump heads of greater than 1m please contact your local AEG Service Force Centre.

Technical data

Height Adjustment

approx. +10 / -5mm

Load (depending on the programme)

max. 5kg

Area of use

Domestic

Drum speed, spinning

see rating plate

Water pressure

1-10bar

(=10-100 N/cm²= 0.1-1.0 Mpa)

Dimensions

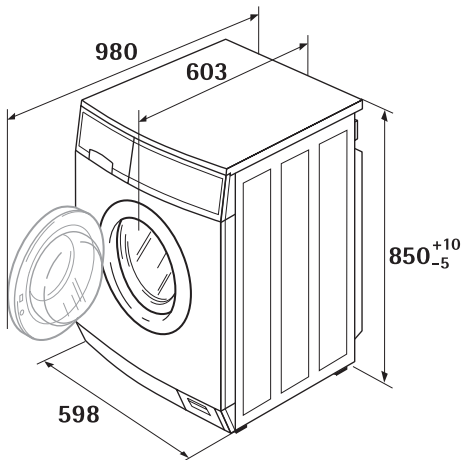

(dimensions in mm)

Warranty conditions

Great Britain

Guarantee Conditions

AEG offer the following guarantee to the first purchaser of this appliance.

1. The guarantee is valid for 12 months commencing when the appliance is handed over to the first retail purchaser, which must be verified by purchase invoice or similar documentation.
The guarantee does not cover commercial use.
2. The guarantee covers all parts or components which fail due to faulty workmanship or faulty materials. The guarantee does not cover appliances where defects or poor performance are due to misuse, accidental damage, neglect, faulty installation, unauthorised modification or attempted repair, commercial use or failure to observe requirements and recommendations set out in the instruction book.
This guarantee does not cover such parts as light bulbs, removable glassware or plastic, dust bags or filters.
3. Should guarantee repairs be necessary the purchaser must inform the nearest customer service office (manufacturer's service or authorised agent). AEG reserves the right to stipulate the place of the repair (i. e. the customer's home, place of installation or AEG workshop).
4. The guarantee or free replacement includes both labour and materials.
5. Repairs carried out under guarantee do not extend the guarantee period for the appliance. Parts removed during guarantee repairs become the property of AEG.
6. The purchaser's statutory rights are not affected by this guarantee.

European Guarantee

If you should move to another country within Europe then your guarantee moves with you to your new home subject to the following qualifications:

- The guarantee starts from the date you first purchased your product.
- The guarantee is for the same period and to the same extent for labour and parts as exist in the new country of use for this brand or range of products.
- This guarantee relates to you and cannot be transferred to another user.
- Your new home is within the European Community (EC) or European Free Trade Area.
- The product is installed and used in accordance with our instructions and is only used domestically, i. e. a normal household.
- The product is installed taking into account regulations in your new country.

Before you move please contact your nearest Customer Care Centre, listed below, to give them details of your new home. They will then ensure that the local Service Organisation is aware of your move and able to look after you and your appliances.

France	Senlis	+33 (0) 44 62 29 29
Germany	Nürnberg	+49 (0) 911 323 2600
Italy	Pordenone	+39 (0) 1678 47053
Sweden	Stockholm	+46 (0) 8 738 7910
UK	Slough	+44 (0) 1753 219899

Index

C

- Changing the program 23
- Child safety feature30, 37
- Circulation pump9, 29
- Conditioner 9, 11, 16, 17, 21, 26
- Cottons 10, 15, 25, 26
- Curtains 14
- Customer Service28, 55

D

- Delay timer 10, 12, 19, 22
- Delicates 11, 15, 25, 26
- Detergent 9, 16, 17, 21
- Detergent Dispenser Drawer9, 21
- Duration19, 22

E

- Easy iron 11, 15, 25, 32
- Easy-cares 11, 15, 25, 26
- Emergency emptying 35
- Energy saving10, 25

F

- Fabric softener 21

G

- Gentle rinse11, 26

H

- Hand wash11, 25

L

- Linen 10, 15, 25
- Load13, 25

M

- Multi-display 10, 19, 22, 30, 55

O

- Open the door 20, 24, 33
- Over-dosed 24

P

- Pre wash 12, 19, 21, 25
- Pre-washing detergent9, 21
- Program progress display10, 22
- Pump out11, 24

Q

- Quick wash 12, 23, 25

R

- Rating plate9, 43, 44, 55
- Rinse 11, 26
- Rinse hold 11, 18, 24
- Rinse+36
- Risk of frost 6, 35

S

- Service Et Spare Parts55
- Silk 11, 15
- Soaking 12, 19, 21, 25
- Softener9
- Spin 11, 17, 18, 23, 26
- Stain removers 9, 21
- Stains 12, 23, 25
- Starching 11, 26
- Stopping the program23

U

- Update13

W

- Warranty 6, 50
- Washing
 - coloureds14
 - lightly soiled 8, 12
- Water
 - hardness16
 - pump off 11, 24
 - softener9, 16, 21
- Woollens 11, 25, 26
 - Hand-washable 11, 15, 25

Service & Spare Parts

If after carrying out the necessary checks there is still a fault with your appliance please contact your local AEG Service Force Centre.

In guarantee customers should ensure that the suggested checks have been made as the engineer will make a charge if the fault is not a mechanical or electrical breakdown.

Please note that proof of purchase is required for in-guarantee service calls.

Service & Spare Parts

If you require a service engineer or wish to purchase spare parts, contact your local AEG Service Force Centre, by telephoning:

0870 5 929 929

Help us to help you

Please determine your type of enquiry before telephoning. When you contact us we need to know:

1. Your name, address, post code and your telephone number.
2. Clear and concise details of the fault.
 - What is the fault?
 - When does the fault occur?
 - Does the multi-display issue an error-message?
3. The model, production number and product identification number.
4. Date of purchase.

This information can be found on the rating plate, so you have these numbers to hand we recommend you write them below.

PNC

S-No.

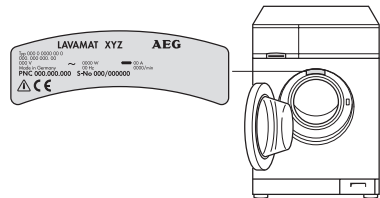

Customer Care

For general enquiries regarding your AEG appliance, or further information on AEG products please contact our customer care department by letter or telephone at the address below or visit our website at

www.aeghome.co.uk

Customer Care Department
 AEG Domestic Appliances
 55-77 High Street, Slough, Berkshire SL1 1DZ
 Tel: 08705 350350*

*Calls to this number may be recorded for training purposes.

The Electrolux Group is the world's largest producer of powered appliances for kitchen, cleaning and outdoor use. More than 55 million Electrolux Group products (such as refrigerators, cookers, vacuum cleaners, chain saws and lawn mowers) are sold each year to a value of approx. 14 billion USD in more than 150 countries around the world.



From the Electrolux Group. The world's No.1 choice.

AEG Hausgeräte GmbH
Postfach 1036
D-90327 Nürnberg

<http://www.aeg.hausgeraete.de>

© Copyright by AEG

822 942 678-01-021001-05

Subject to change without notice