

DUCTS

if the rangehood is installed in the recirculating mode, unscrew and slide out the vent cover "A". If the rangehood is to be installed as a ducted unit, remove the appropriate duct knock-out (top or rear) and ensure the vent cover is fastened in place. Refer also to Ducting Options.

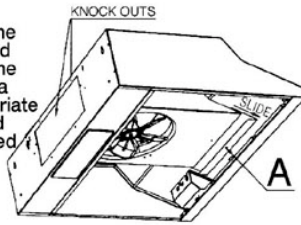

OPERATION

After your Rangehood is fixed in position:

1. Check that the light and the diffuser are in place.
2. See that the filters are correctly positioned.
3. Plug into 230/240V 3 pin outlet. Keep cord clear of stove elements or hot utensils. Permanent wiring to house supply, or modifications to plug or wire should be carried out by a registered electrician.

CLEANING

1. Disconnect the Rangehood from power supply.
2. Wash aluminium filters every 2 or 3 months, depending on usage, with hot soapy water or in the dishwasher.
3. Charcoal filters are disposable items and should be replaced when cleaning the rangehood.
4. Clean the external and internal surfaces including the fan blades, using a damp cloth and mild detergent. Do not use any powder or abrasive cleaners.
5. In high humidity and coastal environments, cleaning should be carried out frequently.

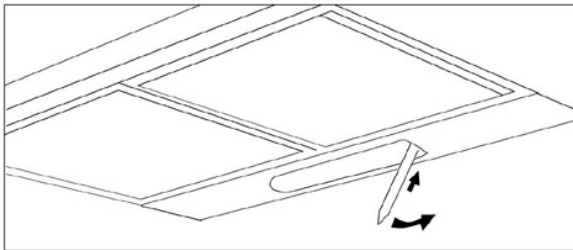

LAMP REPLACEMENT

1. Disconnect the Rangehood from power supply.
2. Insert small screwdriver or slim knife as shown, ease catch to side and slip out the diffuser.
3. Replace lamp (40 watt max).
4. Slide diffuser back into aperture and 'click' into place.

PARTS AND SERVICE

For Accessories, Parts or Services, please contact your local supplier or approved service agent. (Refer to the Warranty Certificate)

WARNING

- This appliance is not intended for use by young children or infirm persons without supervision.
- Young children should be supervised to ensure that they do not play with the appliance.
- There shall be adequate ventilation of the room when the range hood is used at the same time as appliances burning gas or other fuels.
- You must read the details concerning the method and frequency of cleaning.
- There is a fire risk if cleaning is not carried out in accordance with the instructions.
- Do not flambé under the range hood.
- Exhaust air must not be discharged into an existing flue which is used for exhausting fumes from appliances burning gas or other fuels.
- The minimum distance between the hob surface and the lowest part of the range hood is 600mm. This distance shall be at least 650mm if the range hood is installed over a gas hob.
- That regulations concerning the discharge of exhaust air have to be fulfilled.
- If the supply cord of this equipment is damaged, it must only be replaced by the manufacturer or its service agent or similarly qualified person in order to avoid a hazard.

**Electrical Rating:
280W (1.16A) Max. at 240V 50Hz**

Fisher & Paykel INSTALLATION INSTRUCTIONS

MODELS

87641, 87642, 87643
87644, 87645, 87646

To be used together with mounting instructions

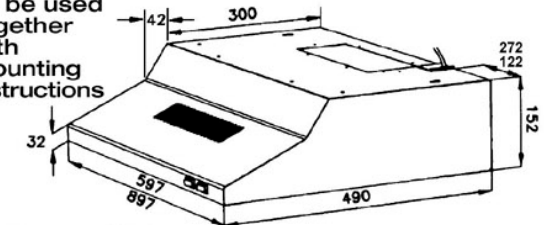

WALL MOUNTING 600mm and 900mm sizes

For mounting with rear rectangular ducts on internal walls cut hole to dimensions shown (UNIDUCT ONLY)

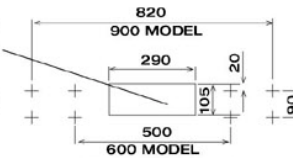

For external walls cut hole 90 x 290mm (UNIDUCT ONLY)

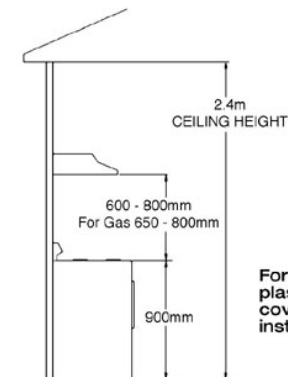
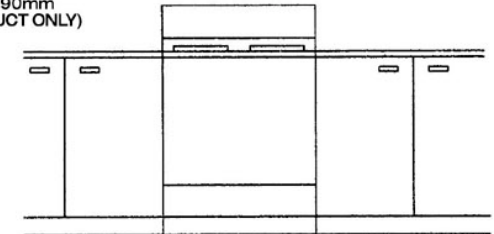

For stainless steel models ensure the plastic protective covering is removed before installation.

103600
Issue "D"

UNDERCUPBOARD MOUNTING Model 600

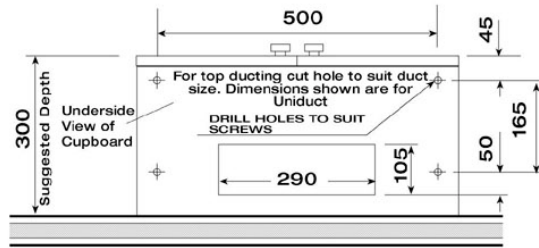

UNDERCUPBOARD MOUNTING Model 900

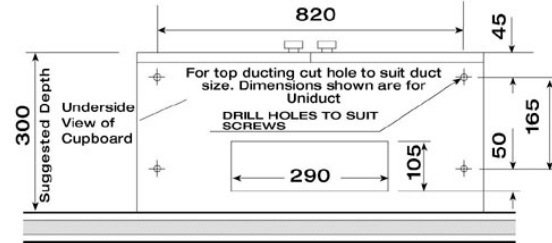

DUCTING OPTIONS

RECIRCULATING

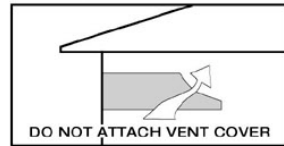

REAR DUCTED

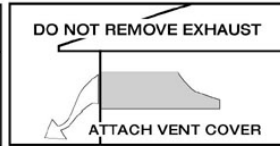

FLEXIBLE DUCT FOR SIDE DUCTING

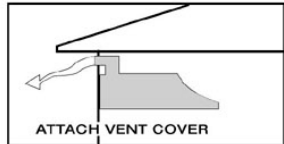

TOP DUCTED THROUGH ROOF

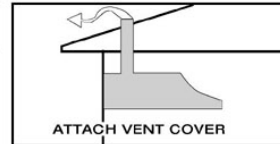

NOTE: when ducting

Exhaust air must not be discharged into any chimney or flue which may carry combustion products from other sources. In addition, exhaust air must not be discharged into a wall cavity, unless designed for the purpose.

MOUNTING OPTIONS

MOUNTING TO REAR WALL



MOUNTING UNDER CUPBOARDS

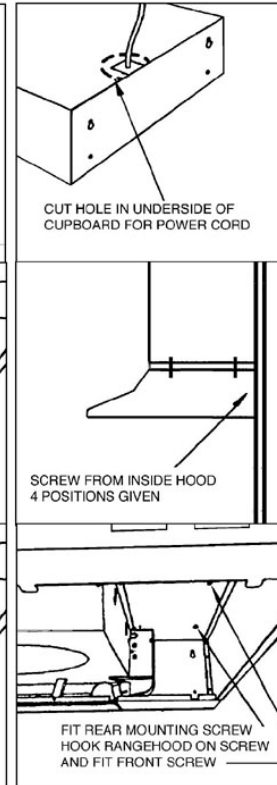

NOTE:
Fastening screws and plugs are not supplied due to the various types and thickness of fixing surfaces available. Contact your local hardware outlet.

WALL MOUNTING DETAILS

FOR INSTALLATION OF PLUGS FOR WALL MOUNTING

1. Mark location of holes as per installation instructions.
2. Drill hole.
Note: Do not use a screw driver to punch a hole in the base material.
3. Insert Plastic Toggle and tap with a hammer to ensure it is flush with the base material.

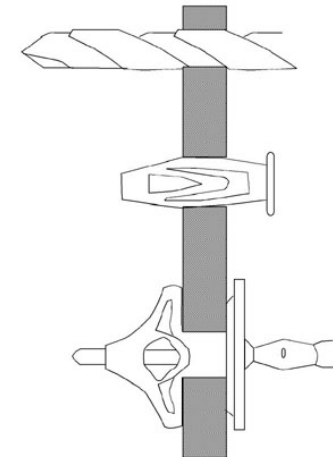

**NOT FOR USE
IN SOLID WALLS**

**FOR SOLID WALLS
USE APPROPRIATE WALL PLUGS**