



Use & Care

G U I D E

One and Two Speed Automatic Washers

A Note to You	2
Washer Safety	3
Parts and Features	4
Operating Your Washer	5
Using your washer	5
Selecting a cycle and time	7
Cycle descriptions	8
Rinse/drain and spin	9
MAGIC CLEAN* lint filter	9
Understanding normal washer sounds	9
Understanding what happens in each cycle ..	10
Caring for Your Washer	11
Troubleshooting	12
Requesting Assistance or Service	16



A NOTE TO YOU

Thank you for buying a WHIRLPOOL* appliance.

The Whirlpool Brand is committed to designing quality products that consistently perform for you to make your life easier. To ensure that you enjoy years of trouble-free operation, we developed this Use and Care Guide. It is full of valuable information about how to operate and maintain your appliance properly and safely. Please read it carefully.

Also, please complete and mail in the Ownership Registration Card provided with your appliance. The card helps us notify you about any new information on your appliance.

Please record your model's information.

Whenever you call to request service for your appliance, you need to know your complete model number and serial number. You can find this information on the model and serial number label (see the diagram on the "Parts and Features" page for the location of the label). Also, record the other information shown in the next column.

Model Number _____

Serial Number _____

Purchase Date _____

Dealer Name _____

Dealer Address _____

Dealer Phone _____

Keep this book and the sales slip together in a safe place for future reference.

For assistance or service, please see the "Requesting Assistance or Service" section.

WASHER SAFETY

Your safety and the safety of others is very important.

We have provided many important safety messages in this manual and on your appliance. Always read and obey all safety messages.



This is the safety alert symbol.

This symbol alerts you to hazards that can kill or hurt you and others.

All safety messages will be preceded by the safety alert symbol and the word "DANGER" or "WARNING." These words mean:

⚠ DANGER

You will be killed or seriously injured if you don't follow instructions.

⚠ WARNING

You can be killed or seriously injured if you don't follow instructions.

All safety messages will identify the hazard, tell you how to reduce the chance of injury, and tell you what can happen if the instructions are not followed.

IMPORTANT SAFETY INSTRUCTIONS

WARNING – To reduce the risk of fire, electric shock, or injury to persons when using the washer, follow basic precautions, including the following:

- Read all instructions before using the washer.
- Do not wash articles that have been previously cleaned in, washed in, soaked in, or spotted with gasoline, dry-cleaning solvents, other flammable, or explosive substances as they give off vapours that could ignite or explode.
- Do not add gasoline, dry-cleaning solvents, or other flammable, or explosive substances to the wash water. These substances give off vapours that could ignite or explode.
- Under certain conditions, hydrogen gas may be produced in a hot water system that has not been used for 2 weeks or more. **HYDROGEN GAS IS EXPLOSIVE.** If the hot water system has not been used for such a period, before using the washing machine, turn on all hot water faucets and let the water flow from each for several minutes. This will release any accumulated hydrogen gas. As the gas is flammable, do not smoke or use an open flame during this time.
- Do not allow children to play on or in the washer. Close supervision of children is necessary when the washer is used near children.
- Before the washer is removed from service or discarded, remove the door.
- Do not reach into the washer if the tub or agitator is moving.
- Do not install or store the washer where it will be exposed to the weather.
- Do not tamper with controls.
- Do not repair or replace any part of the washer or attempt any servicing unless specifically recommended in this Use and Care Guide.
- See Installation Instructions for grounding requirements.

– SAVE THESE INSTRUCTIONS –

PARTS AND FEATURES

The drawings in this book may vary from your washer model. They are designed to show the different features of all models covered by this book. Your model may not include all features.

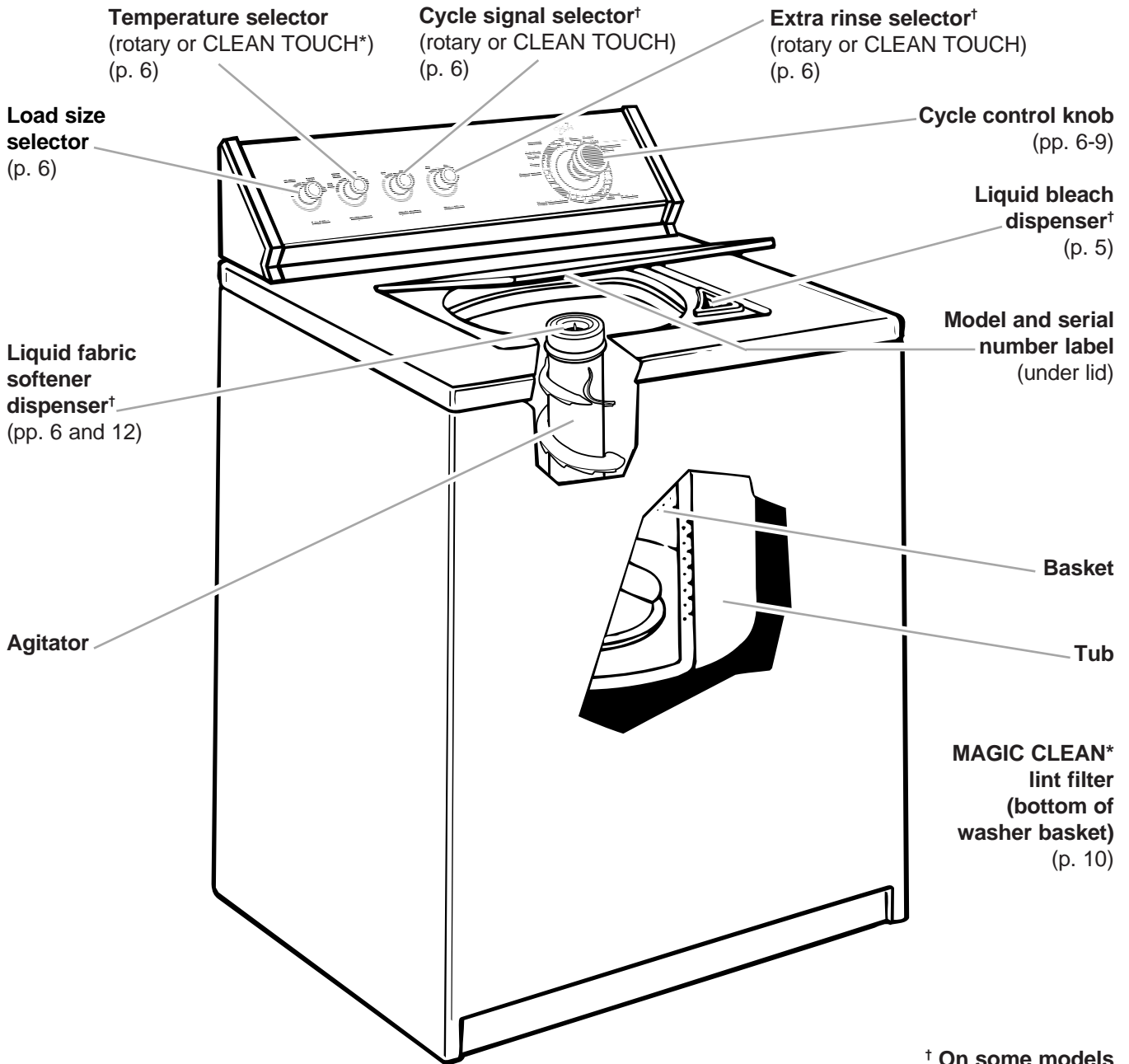

OPERATING YOUR WASHER

USING YOUR WASHER

⚠ WARNING



Fire Hazard

Never place items in the washer that are dampened with gasoline or other flammable fluids.

No washer can completely remove oil.

Do not dry anything that has ever had any type of oil on it (including cooking oils).

Doing so can result in death, explosion, or fire.

⚠ WARNING



Electrical Shock Hazard

Plug into an earthed plug socket outlet.

Do not remove earth pin.

Do not use an adapter.

Do not use an extension cord.

Failure to follow these instructions can result in death, fire, or electrical shock.

1. Measure detergent and pour it into the washer.

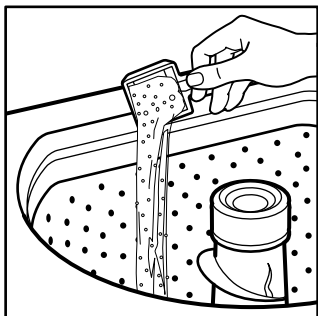

- If desired, you may also add powder or liquid colour safe bleach. If the water temperature is low, dilute the detergent in warm water.
- Add extra detergent for the Super Wash cycle.

2. Drop a sorted load of clothes loosely into your washer, filling to the top row of holes.

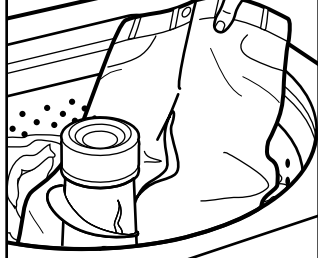

- Load evenly to maintain washer balance. An off balance load can make the washer vibrate during spin.
- Mix large and small items. Larger items such as sheets should be loaded last.

- Items should move easily through the wash water. Overloading can cause poor cleaning.
- To reduce wrinkling of permanent press clothes and some synthetic knits, use a large load size to provide more space (see step 6).

3. (OPTIONAL STEP) Pour measured liquid bleach

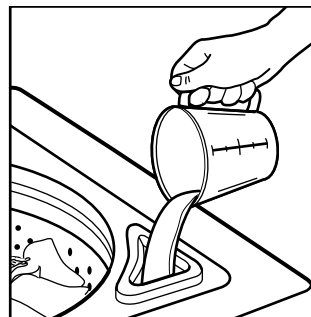

into the liquid bleach dispenser. Bleach will be diluted automatically during the wash part of the cycle.

- Never use more than 250 mL (1 cup) for a full load. Use less with a smaller load size.
- Follow the manufacturer's

directions for safe use.

- To avoid spilling, use a cup with a pouring spout. Do not let bleach splash, drip, or run down into the washer basket.
- Make sure you use only liquid bleach in this dispenser.

continued on next page

USING YOUR WASHER (CONT.)

4. (OPTIONAL STEP) Pour measured **liquid fabric softener** into the liquid fabric softener dispenser.

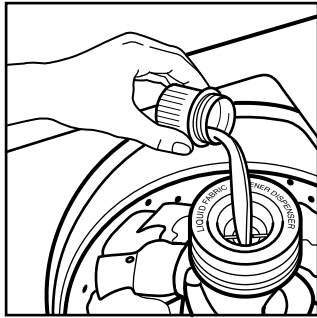

- Do not spill or drip any fabric softener on the clothes.
- Make sure you use only liquid fabric softener in this dispenser.
- If your model does **not** have a liquid fabric softener dispenser, see Step 12.

Dilute liquid fabric softener by filling the dispenser with warm water until liquid reaches the crossbar in the opening.

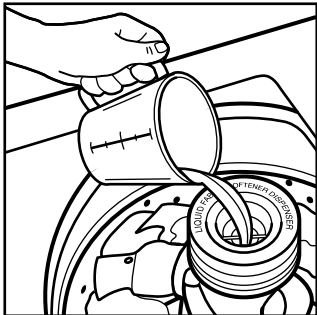

- Softener is added automatically during the rinse portion of the cycle.

5. Close the washer lid.

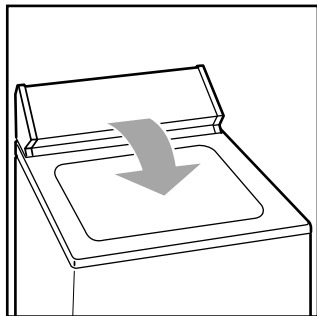

6. Turn the Load Size selector to the correct setting for your wash load and the type of fabric being washed.

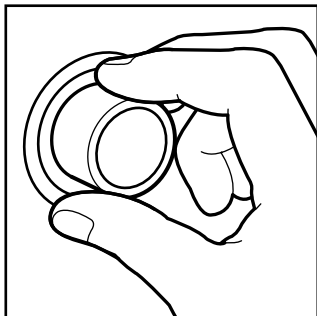

- Choose a load size that allows the load to move freely for best fabric care.
- Change the setting after the washer has started filling by turning the selector to a

different setting. If your washer has a RESET option, first move the selector to RESET, then to the new water level.

7. Set the Water Temperature selector to the correct setting for the type of fabric and soils being washed.

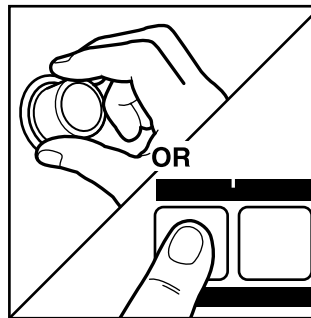

- Use the warmest water safe for fabric.
- Follow garment label instructions.
 - HOT:** 49°C (120°F) or above
 - Whites and pastels
 - Heavy and greasy soils
 - WARM:** 32° to 44°C (90° to 110°F)
 - Bright colours
 - Moderate to light soils
 - COLD:** 21° to 32°C (70° to 90°F)
 - Colours that bleed or fade
 - Light soils

8. (OPTIONAL STEP) Some models have an Extra Rinse selector. For an additional rinse and spin at the end of a wash cycle, set the Extra Rinse selector to ON.

9. (OPTIONAL STEP) Some models have a Cycle Signal option. Set the Cycle Signal selector to On if you want your washer to sound a signal when the wash cycle is finished. This signal is helpful when you are washing items that should be removed from the washer as soon as the cycle ends.

USING YOUR WASHER (CONT.)

10. Push in the Cycle Control knob and turn it to the wash cycle you want. See “Cycle descriptions.”

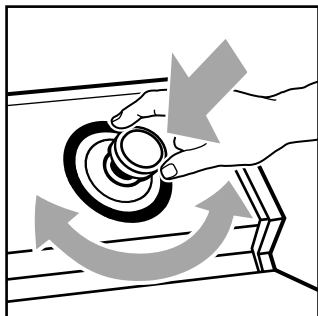

• Reduce the wash time when using a small load size setting.

11. Pull out the Cycle Control knob to start the washer.

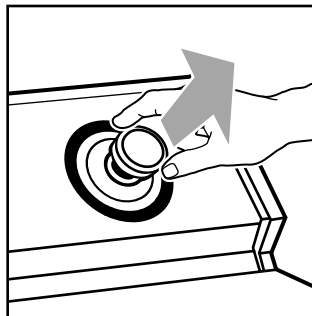

12. (OPTIONAL STEP) On models with no liquid fabric softener dispenser, add measured liquid fabric softener to the rinse water.

NOTE: To **stop** the washer at any time, push in the Cycle Control knob. Do not stop the washer during water pump out. To **restart** the washer, close the lid (if open) and pull out the Cycle Control knob.

SELECTING A CYCLE AND TIME

This section describes the available wash cycles and will help you make the best cycle selections for your wash loads. Each cycle is designed for different types of fabric and soil levels.

NOTE: When tested to AS2040-1990 for wash performance, the Regular/Normal cycle was selected with extra large load size, warm wash, and cold rinse.

- The washer pauses briefly throughout each cycle. These pauses are normal. Refer to “Understanding normal washer sounds” to learn more about the sounds you may hear during a wash cycle.
- Refer to “Understanding what happens in each cycle” to learn what happens during a wash cycle.

CYCLE DESCRIPTIONS

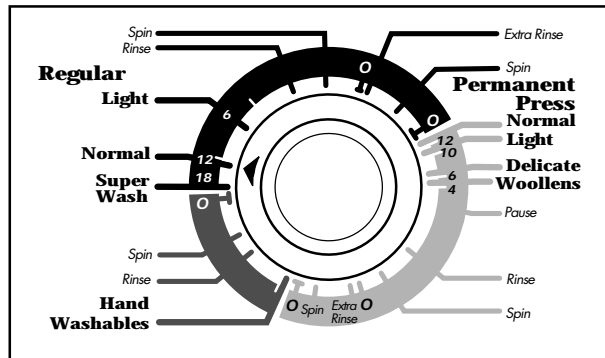

Cycles may vary with model

Regular cycle

The Regular cycle features high speed agitation. High spin speeds shorten drying time. Use 6 (Light) or 12 (Normal) minutes of wash time for cleaning sturdy cotton and linen fabrics that are moderately or heavily soiled.

Super Wash – The Super Wash cycle automatically prewashes the laundry and advances into the Normal cycle. Use this cycle when washing heavily soiled loads that need maximum soil removal. Use two times the recommended amount of detergent for this cycle.

Permanent Press

Use the Permanent Press cycle for cleaning permanent press and some synthetic fabrics that are lightly or moderately soiled.

1-speed models – The Permanent Press cycle features a cool-down rinse to reduce wrinkling.

2-speed models – The Permanent Press cycle starts with high agitation and then steps to low. To reduce wrinkling, this cycle features a cool-down rinse and a low speed final spin.

Delicate cycle (on some models)

The Delicate cycle features a reduced agitation speed for gentle soil removal. Low spins reduce wrinkling. Use this 6-minute cycle for cleaning delicate items and washable knits that are lightly or moderately soiled.

Woollens cycle (on some models)

The Woollens cycle features a reduced agitation speed for gentle soil removal. Select warm wash and warm rinse water when using this cycle. Use this 4-minute cycle for washable woollens and knits that are lightly soiled.

Hand Washables cycle (on some models)

The Hand Washables cycle features a brief period of low speed agitation and soak time (2 seconds agitation, 28 seconds soak) which is repeated for six minutes. Low spin speed reduces wrinkling. Use this cycle for cleaning lightly soiled hand washables.

Garments are labeled “Hand Wash” because:

- The fibre or construction may be sensitive to agitation.
- The fabric contains sensitive dyes that may bleed. Properly sort and then use your Hand Washables cycle for gentle washing. Follow care label directions for drying. Items that may shrink should be dried flat. Block these items by gently stretching to original measurements. Woollens tend to shrink more the first time they are washed.
- If items appear to be floating due to trapped air, stop the washer by pushing in the Cycle Control knob. Push items down into the water. Restart the washer.

Soak cycle (on some models)

The Soak cycle features a brief period of agitation and soak time to help remove heavy soils and stains that need pretreatment. The soak period will continue as long as you like. Thirty minutes or less is recommended for most situations.

- Use warm water when soaking laundry. Hot water can set stains.
- Use the amount of detergent or presoak additive recommended by the manufacturer.
- When you have decided to end the Soak cycle, turn the Cycle Control knob to Prewash or Spin.
- Next, add detergent and start a new wash cycle.

CYCLE DESCRIPTIONS (CONT.)

Prewash cycle (on some models)

The Prewash cycle features a brief period of high speed agitation to help remove heavy soils and stains that need pretreatment.

- Use warm water for prewashing stained laundry. Hot water can set stains.
- After the Prewash cycle ends, add detergent and set a new wash cycle.

RINSE/DRAIN AND SPIN

Rinse and Spin feature

When using extra detergent for heavily soiled clothes, or washing special-care items, you may find an extra rinse and spin is needed.

- For an additional rinse and spin, push in the Cycle Control knob and turn it to any of the Rinse settings. The washer fills to the selected load size, agitates, drains, and spins.

NOTE: An Extra Rinse option is available on some models. See “Using your washer.”

Drain and Spin feature

A drain and spin may help shorten drying times for some heavy fabrics or special-care items by removing excess water.

- For a drain and spin, push in the Cycle Control knob and turn it to any of the Spin settings. Then pull out the Cycle Control knob. The washer drains, then spins.

MAGIC CLEAN* LINT FILTER

Your washer has a MAGIC CLEAN lint filter at the bottom of the basket. Wash and rinse water flow over the filter during agitation, separating the lint from the water. The lint spins out of the system during the spin part of the cycle.

If your washer drains into a tub, remove any lint collected in the tub or strainer.

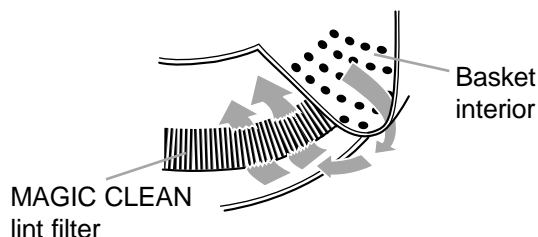

UNDERSTANDING NORMAL WASHER SOUNDS

Your new washer may make sounds your old one didn't. Because the sounds may be unfamiliar, you may be concerned about them. Don't be; most of them are normal.

The following describes some of the sounds you may hear and what causes them.

During washing

When you select a small load size setting, your washer has a lower water level. This may cause a clicking sound from the upper part of the agitator.

During drain

If water is drained quickly from your washer (depending on your installation), you may hear air being pulled through the pump during the end of draining.

After drain and before spin

When the cycle changes from draining to spinning, you may hear gears engaging.

UNDERSTANDING WHAT HAPPENS IN EACH CYCLE

When the Cycle Control knob is set to a number and pulled out, the washer fills (to the selected load size) before agitation and timing start. The washer begins agitating immediately after filling; agitation occurs with the washer lid up or down.

During agitation, the agitator creates a continuous rollover action that provides a thorough cleaning of the wash load.

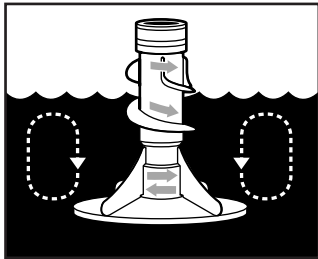











After agitation starts, the Cycle Control knob turns clockwise until it points to an Off area and the cycle ends.

NOTES:

- The washer pauses briefly throughout each cycle. These pauses are normal for washer operation.
- On two-speed models, a Gentle Wash system helps protect your fabrics by reducing wash agitation speed during the last few minutes of wash agitation in the Regular and Permanent Press cycles.

Sequence of cycles

WASH	
	Fill ↓
	Wash selected time ↓
	Drain† No agitation ↓
	Spin ↓
† The Permanent Press cycle partially drains, fills, agitates briefly, and drains.	

RINSE	
	Fill ↓
	Rinse ↓
	Drain-No agitation ↓
	Spin-Spray rinse ↓
	Spin ↓
	Off

CARING FOR YOUR WASHER

CLEANING YOUR WASHER

Cleaning the exterior

Use a soft, damp cloth or sponge to wipe up any spills such as detergent or bleach. Occasionally wipe the outside of your washer to keep it looking new.



Cleaning the interior

Clean your washer interior by mixing 250 mL (1 cup) of liquid bleach and 500 mL (2 cups) of detergent. Pour this into your washer and run it through a complete cycle using hot water. Repeat this process if necessary.

NOTE: Remove any hard water deposits using only cleaners labeled as washer safe.

Cleaning the liquid fabric softener dispenser

Flush dispenser periodically with warm water, as shown. Remove the dispenser by grasping the top of the dispenser with both hands and squeezing and pushing upwards with thumbs. Clean the dispenser by rinsing it under a water faucet. Replace it after cleaning.

NOTE: Do not wash clothes with this dispenser removed. Do not add detergent or bleach to this dispenser; it is for liquid fabric softener use only.

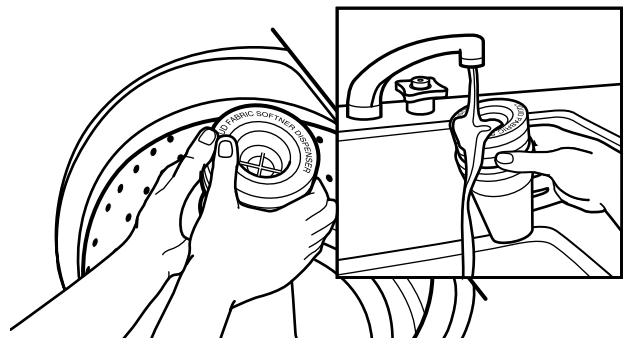

WINTER STORAGE, MOVING, VACATION CARE

Install and store your washer where it will not freeze. Because some water may stay in the hoses, freezing can damage your washer. If storing or moving your washer during freezing weather, winterize it.

To winterize washer:

1. Shut off both water faucets.
2. Disconnect and drain water inlet hoses.
3. Put 1 L (1 quart) of R.V.-type antifreeze in the basket.
4. Run washer on a drain and spin setting (see the "Rinse/Drain and Spin" section) for about 30 seconds to mix the antifreeze and water.
5. Unplug the power supply cord.

To use washer again:

1. Flush water pipes and hoses.
2. Reconnect water inlet hoses.
3. Turn on both water faucets.
4. Reconnect power supply cord.
5. Run the washer through a complete cycle with 250 mL (1 cup) of detergent to clean out antifreeze.

Non-use or vacation care:

Operate your washer only when you are at home. If you will be on vacation or not using your washer for an extended period of time, you should:

- Unplug the power supply cord or turn off electrical power to the washer.
- Turn off the water supply to the washer. This helps avoid accidental flooding (due to a water pressure surge) while you are away.

TROUBLESHOOTING

COMMON WASHING PROBLEMS

Problem ...	Cause ...	Solution ...
<p>Washer leaks</p> <p>NOTE: After checking these, check household plumbing.</p>	<ul style="list-style-type: none"> • Fill hoses not tight. • Fill hose washers not properly seated. • Drain hose clamp not properly installed or is off. • Drain is clogged. • Tub moved forward during unloading, causing water to deflect off tub ring. • Unit not level, causing water to deflect off tub ring. • Fill or spray rinses are deflecting off load. Washer is overloaded or load is unbalanced. 	<ul style="list-style-type: none"> • Tighten hoses. See Installation Instructions. • Reseat (reposition) washers. See Installation Instructions. • Clamp drain hose. • Unclog drain. Sink and standpipe must be able to handle 64 L (17 gallons) of water per minute. • Ensure tub is centred before starting washer. • Ensure front feet are installed and nuts are tightened. Level washer. • Redistribute the load, or reduce load size.
<p>Washer won't drain/spin</p>	<ul style="list-style-type: none"> • Drain hose is clogged. • Lid is open. • End of drain hose more than 183 cm (72 inches) above floor. • Too much detergent – excessive sudsing. • Low voltage or using an extension cord. 	<ul style="list-style-type: none"> • Unclog hose. See Installation Instructions for proper installation of drain hose. • Close the lid. • Lower drain hose. • Use less detergent. • Check electrical source or call electrician. Do not use extension cords.
<p>Wet loads</p>	<ul style="list-style-type: none"> • Wrong cycle for load being washed. • Cold rinses. 	<ul style="list-style-type: none"> • Choose a cycle with a higher spin speed. • Cold rinses leave loads wetter than warm rinses. This is normal.
<p>Washer continues to fill/drain or cycle stuck</p> <p>NOTE: Washer pauses briefly throughout each cycle. This is normal.</p>	<ul style="list-style-type: none"> • Top of drain hose is lower than water level in washer. • Drain hose fits too tightly into standpipe. • Drain hose taped into standpipe. 	<ul style="list-style-type: none"> • Raise the drain hose. It must be higher for proper operation. • Adjust drain hose for loose yet secure fit. See Installation Instructions. • Do not seal off drain hose with tape. The hose needs an air gap.
<p>Washer makes noise</p>	<ul style="list-style-type: none"> • Load is unbalanced. • Washer is not level. • Nuts on front feet not tight. • Yellow shipping strap with cotter pins not completely removed. 	<ul style="list-style-type: none"> • Redistribute load. • Level washer. Reset rear leveling legs. See Installation Instructions. • Tighten nuts. • See Installation Instructions.

COMMON WASHING PROBLEMS (CONT.)

Problem...	Cause...	Solution...
Washer makes noise (cont.)	<ul style="list-style-type: none"> ● Gears engaging after drain and before spin. ● Upper part of agitator clicks during wash. 	<ul style="list-style-type: none"> ● This is normal. ● This is normal.
Won't fill/rinse/agitate or wrong temperature	<ul style="list-style-type: none"> ● Power cord not plugged in. ● Cycle Control knob is not lined up. ● Water inlet valve screens are plugged. ● Water is turned off. ● Hot and cold hoses are reversed. ● Inlet hoses are kinked. 	<ul style="list-style-type: none"> ● Plug in power cord. ● Turn Cycle Control knob to the right slightly and pull to start. ● Clean screens. ● Turn on water. ● Reverse hoses. ● Straighten hoses.
Washer stops	<ul style="list-style-type: none"> ● Power cord not plugged in. ● No power at plug. ● Fuse blown or circuit breaker open. ● Using an extension cord. ● Cycle Control knob is not lined up. ● Cycle Control knob not pulled out. ● Washer at pause in Permanent Press cycle (approximately 2 minutes). ● Machine is overloaded. 	<ul style="list-style-type: none"> ● Plug in power cord. ● Check electrical source or call electrician. ● Replace fuse or reset circuit breaker. If problem continues, call electrician. ● Do not use extension cords. ● Turn knob to the right slightly and pull to start. ● Set and pull out knob. ● Allow cycle to continue. ● Wash smaller loads.
Agitator operation	<ul style="list-style-type: none"> ● The top of the agitator moves only in one direction. ● The top of the agitator is loose. 	<ul style="list-style-type: none"> ● This is normal. ● This is normal.
Water level seems too low or washer not completely filling	<ul style="list-style-type: none"> ● The top of the agitator is much higher than the highest water level. This creates a perception of the washer not being full. 	<ul style="list-style-type: none"> ● This is normal.
Washer tub is crooked	<ul style="list-style-type: none"> ● Tub is pulled forward when unloading. ● Tub moves. ● Washer not level. 	<ul style="list-style-type: none"> ● Push tub to center before starting. ● This is normal. ● Ensure front feet are installed and nuts tightened. Level washer. Reset rear leveling legs. See Installation Instructions.

continued on next page

COMMON WASHING PROBLEMS (CONT.)

Problem...	Cause...	Solution...
Residue or lint on load	<ul style="list-style-type: none"> ● Improper sorting. ● Overloading. ● Paper or tissue in pockets. ● Not enough detergent. ● Detergent not dissolving. ● Wash water colder than 21°C (70°F). 	<ul style="list-style-type: none"> ● Sort lint givers (towels, chenille) from lint takers (corduroy, synthetics). Also sort by colour. ● Lint can be trapped in load if overloaded. Wash smaller loads. ● Clean out pockets before washing. ● Use enough detergent to hold lint in water. ● Use wash water warmer than 21°C (70°F). ● Use wash water warmer than 21°C (70°F).
Tearing	<ul style="list-style-type: none"> ● Overloading. Improper use of washer. ● Improper use of liquid bleach. ● Sharp items not removed from pockets; fasteners not fastened. ● Items damaged before washing. 	<ul style="list-style-type: none"> ● Loads should move freely during wash. Wash smaller loads. ● Do not pour liquid bleach directly on load. Wipe up bleach spills. Undiluted bleach will damage fabrics. ● Clean out pockets before washing. Zip zippers before washing. ● Mend rips and broken threads in seams before washing.
Stains on load	<ul style="list-style-type: none"> ● Improper use of fabric softener. ● Iron (rust) in water. ● Not enough detergent used, causing soil to be redeposited. ● Dye transfer due to not sorting loads properly. ● Dye transfer due to not unloading washer promptly. 	<ul style="list-style-type: none"> ● Dilute fabric softener and add to rinse portion of cycle only. Do not drip fabric softener on clothes. ● Install an iron filter. ● Use enough detergent to remove soil and hold it in suspension. ● Sort dark clothing from whites and lights. ● Unload the washer as soon as it stops.
Load is wrinkled	<ul style="list-style-type: none"> ● Not removing load promptly. ● Wrong cycle for fabrics being washed. ● Overloading. ● Wash water not warm enough to relax wrinkles. Use warm rinses. ● Hoses reversed. 	<ul style="list-style-type: none"> ● Unload the washer as soon as it stops. ● Use the Permanent Press cycle or another cycle with low spin speeds to reduce wrinkling. ● Loads should move freely during wash. Wash smaller loads. ● If safe for fabric, use warm or hot wash water. Use cold rinse water. ● Reverse hoses.

COMMON WASHING PROBLEMS (CONT.)

Problem...	Cause...	Solution...
Load is tangled/twisted	<ul style="list-style-type: none"> ● Overloading. ● Clothes wrapped around agitator. 	<ul style="list-style-type: none"> ● Loads should move freely during wash. Wash smaller loads. ● Do not wrap items around agitator.
Clogged dispensers or bleach leaking	<ul style="list-style-type: none"> ● Not diluting softener. ● Use of colour safe bleach in liquid bleach dispenser. ● Improper use of liquid bleach. 	<ul style="list-style-type: none"> ● Dilute fabric softener in the dispenser. ● Add powder or liquid colour safe bleach directly to the basket. Do not use liquid bleach dispenser for colour safe bleach. ● Always measure bleach before adding to the dispenser. Carefully pour into the dispenser. Wipe up bleach spills.
Gray whites, dingy colours	<ul style="list-style-type: none"> ● Dye transfer. ● Wash temperature too low. ● Not enough detergent. ● Hard water. 	<ul style="list-style-type: none"> ● Sort dark clothes from whites and lights. ● Use hot or warm washes if safe for fabric. Hot water should be at least 49°C (120°F) to clean heavy or greasy soils. ● Use more detergent for washing heavy soils in cold or hard water. ● Use more detergent when washing in hard water.

REQUESTING ASSISTANCE OR SERVICE

IF YOU NEED ASSISTANCE OR SERVICE

Call the Whirlpool Consumer Assistance Centre, 1-300-363-344 (Australia), 0-800-442-584 (New Zealand). Our consultants are available to assist you.



When calling:

Please know the purchase date, and the complete model and serial number of your appliance (see the "A Note to You" section). This information will help us better respond to your request.

Our consultants provide assistance with:

- Features and specifications on our full line of appliances
- Installation information
- Use and maintenance procedures
- Accessory and repair parts sales
- Referrals to local dealers, service companies, and repair parts distributors

Whirlpool service technicians are trained to fulfill the product warranty and provide after-warranty service.

NOTE: If the power supply cord of this washer is damaged, it must be replaced by a special cord (Part Number 3353308) available from the dealer from whom you purchased the washer or an authorized service company.

Gearcase assembly covered by warranty.

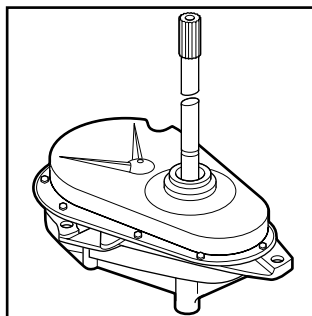

IF YOU NEED REPLACEMENT PARTS

If you need to order replacement parts, we recommend that you only use FSP* factory authorized parts. FSP replacement parts will fit right and work right, because they are made to the same exacting specifications used to build every new WHIRLPOOL* appliance.

To locate FSP replacement parts in your area, call our Consumer Assistance Centre telephone number or your nearest authorized service center.