

TABLE OF CONTENTS

IMPORTANT SAFETY INSTRUCTIONS	2
PARTS CHECK LIST	4
HANDSET UNIT KEYS AND FEATURES	5
BASE UNIT KEYS AND FEATURES	6
SETTING UP YOUR VT 2931	7
WALL MOUNTING	8
BASIC OPERATIONS	
Area Code Programming.....	11
Key Beeps	12
Setting The Handset Ringer.....	12
Base Unit Ringer.....	12
Making Calls.....	12
Redial/Pause.....	13
Answering Calls.....	13
Handset Volume	13
Speakerphone Volume	13
Mute.....	13
Speakerphone Tips.....	14
Call Timer.....	14
Hold.....	14
Call Waiting.....	14
Paging the Handset.....	14
Intercom.....	14
Voice Mail Indicator.....	14
Voice Mail Tips.....	15
Conference Calling.....	15
CALLER ID	
Reviewing the Call Log.....	16
Erasing Calls.....	16
Speed Dialing from Caller ID.....	17
DIRECTORY	
To Store a Name And Number.....	17
Storing a Caller ID Record in the Directory.....	18
Making Directory Calls.....	18
Editing a Directory Entry.....	18
Erasing a Directory Entry.....	18
BASE UNIT OPERATION	
Programming Speed Dial Numbers.....	19
Storing A Pause In A Dialing Sequence.....	19
Speed Dialing.....	19
Base Display.....	20
Data Port.....	20
HEADSET OPERATION	21
MAINTENANCE	22
IN CASE OF DIFFICULTY	23
WARRANTY STATEMENT	25
FCC AND IC REGULATIONS	26
THE RBRC[®] SEAL	28
TECHNICAL SPECIFICATIONS	29

IMPORTANT SAFETY INSTRUCTIONS

When using your telephone equipment, basic safety precautions should always be followed to reduce the risk of fire, electric shock and injury to persons, including the following:

1. Read and understand all instructions.
2. Follow all warnings and instructions marked on the product.
3. Unplug this product from the wall outlet before cleaning. Do not use liquid cleaners or aerosol cleaners. Use a dry cloth for cleaning.
4. Do not use this product near water, for example, near a bath tub, wash bowl, kitchen sink, or laundry tub, in a wet basement, or near a swimming pool.
5. Do not place this product on unstable cart, stand, or table. The telephone may fall, causing serious damage to the telephone.
6. Slots and openings in the cabinet and the back or bottom are provided for ventilation, to protect it from overheating, these openings must not be blocked or covered. The openings should never be blocked by placing the product on the bed, sofa, rug, or other similar surface. This product should never be placed near or over a radiator or heat register. This product should not be placed in a built-in installation unless proper ventilation is provided.
7. This product should be operated only from the type of power source indicated on the marking label. If you are not sure of the type of power supply to your home, consult your dealer or local power company.
8. Do not allow anything to rest on the power cord. Do not locate this product where the cord will be abused by persons walking on it.
9. Do not overload wall outlets and extension cords as this can result in the risk of fire or electric shock.
10. Never push objects of any kind into this product through cabinet slots as they may touch dangerous voltage points or short out parts that could result in a risk of fire or electric shock. Never spill liquid of any kind on the product.
11. To reduce the risk of electric shock, do not disassemble this product, but take it to a qualified service personnel when some service or repair work is required. Opening or removing covers may expose you to dangerous voltages or other risks. Incorrect reassembly can cause electric shock when the appliance is subsequently used.
12. Unplug this product from the wall outlet and refer servicing to qualified service personnel under the following conditions:
 - A. When the power supply cord plug is damaged or frayed.
 - B. If liquid has been spilled into the product.
 - C. If the product has been exposed to rain or water.

IMPORTANT SAFETY INSTRUCTIONS

- D. If the product does not operate normally by following the operating instructions. Adjust only those controls, that are covered by the operating instructions because improper adjustment of other controls may result in damage and will often require extensive work by a qualified technician to restore the product to normal operation.
 - E. If the product has been dropped or the cabinet has been damaged.
 - F. If the product exhibits a distinct change in performance.
13. Do not use the telephone to report a gas leak in the vicinity of the leak.

CAUTION: TO REDUCE THE RISK OF FIRE OR INJURY, READ AND FOLLOW THESE INSTRUCTIONS.

1. Use only the appropriate type and size battery pack specified in the instruction manual provided for this product.
2. Do not dispose of the battery pack in a fire. The cell may explode. Check with State and local codes for possible special disposal instructions.
3. Do not open or mutilate the battery pack. Released electrolyte is corrosive and may cause damage to the eyes or skin. It may be toxic if swallowed.
4. Exercise care in handling battery in order not to short the battery with conducting materials such as rings, bracelets, and keys. The battery or conductor may overheat and cause burns.
5. Charge the battery pack provided with or identified for use with this product only in accordance with the instructions and limitations specified in the instruction manual.
6. Observe proper polarity orientation between the battery pack and battery charger.

SAVE THESE INSTRUCTIONS

PARTS CHECK LIST

1. Handset
2. Base Unit
3. Wall Mounting Bracket
4. AC power Adaptor
5. Short Telephone Line Cord
6. Telephone Line Cords (x2)

7. Battery Pack
8. Belt Clip

To purchase replacement battery packs, call **VTECH** Communications at 1-800-595-9511. In Canada, call VTECH Electronics at 1-800-267-7377.



HANDSET

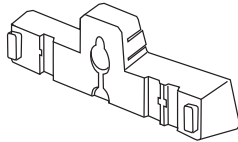

WALL MOUNTING BRACKET

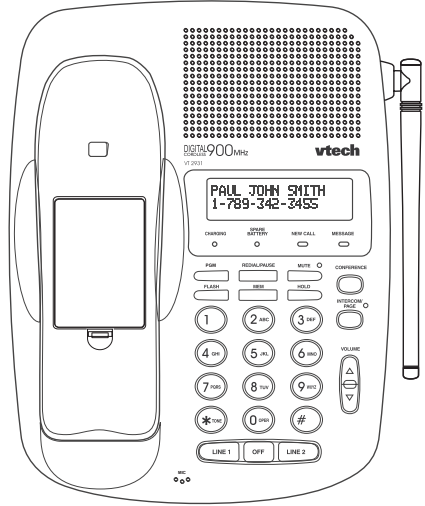

BASE UNIT

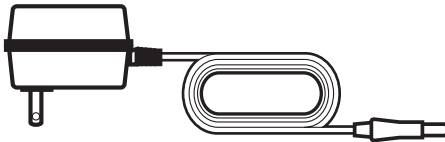

AC POWER ADAPTOR

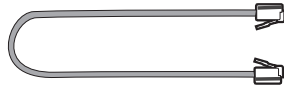

SHORT TELEPHONE LINE CORD



TELEPHONE LINE CORD 2 WIRE



TELEPHONE LINE CORD 4 WIRE

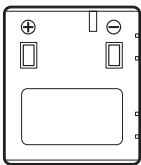

BATTERY PACK

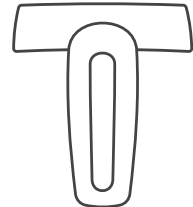

BELT CLIP

HANDSET UNIT KEYS AND FEATURES

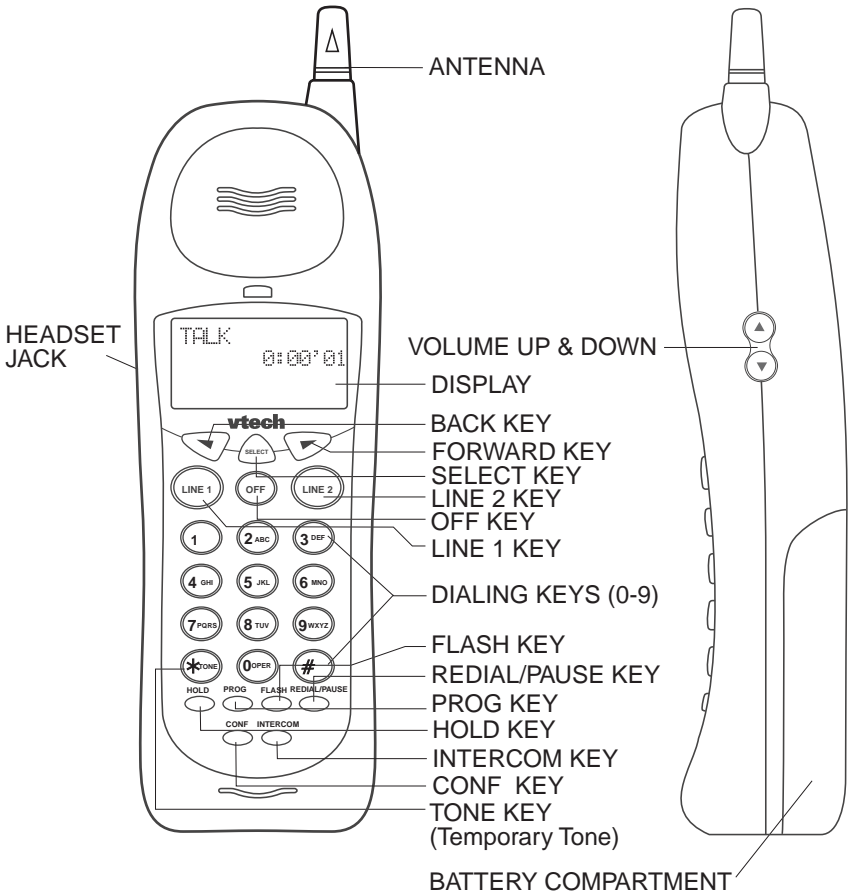

BASE UNIT KEYS AND FEATURES

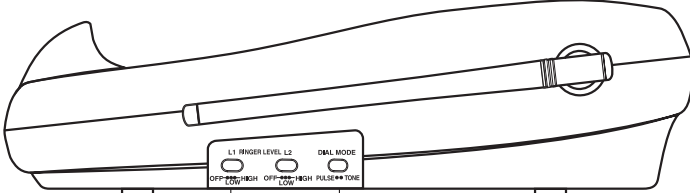
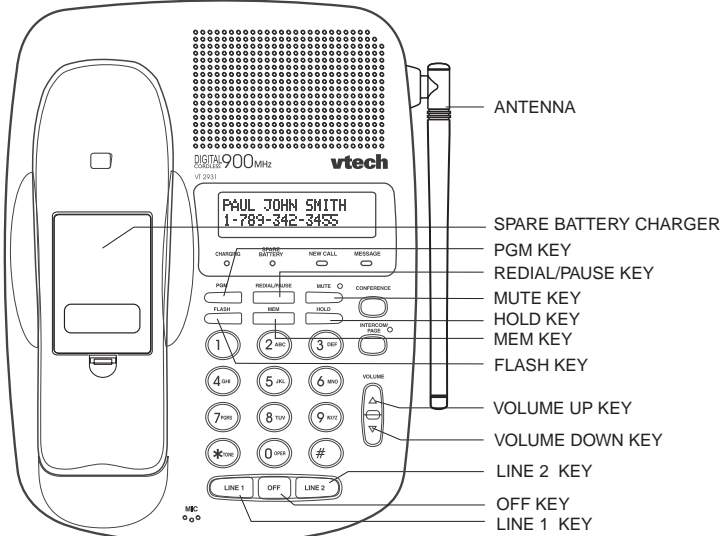

BASE RINGER SWITCHES

TONE/PULSE SWITCH

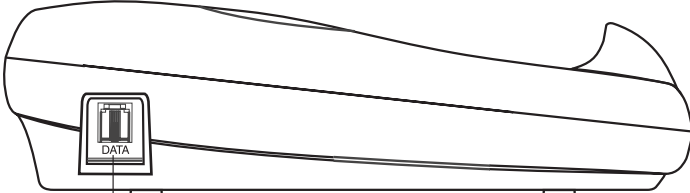

DATA PORT

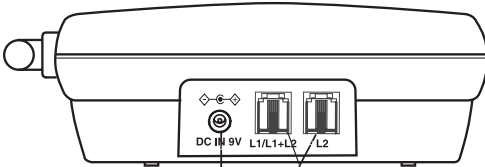

AC POWER JACK

PHONE CORD JACKS

SETTING UP YOUR VT 2931

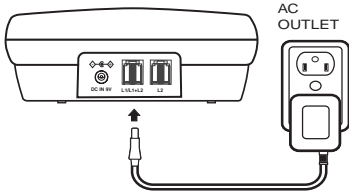

1. Plug the **AC POWER ADAPTER** into a live electrical outlet and the **DC POWER CONNECTOR** into the back of the Base Unit.

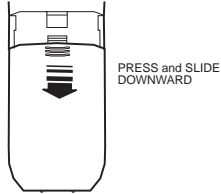

2. Slide the Handset battery cover down, and remove it from the Handset.

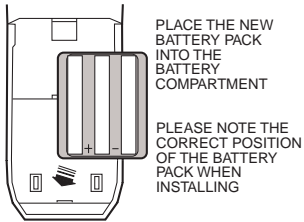

3. Install the **BATTERY PACK**, with the metal contacts facing down and aligned with the Handset contacts. Replace Handset battery cover.

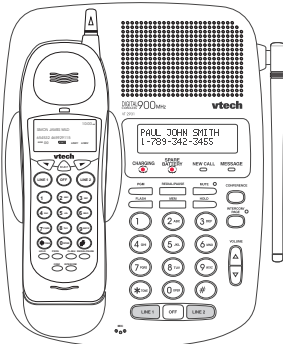
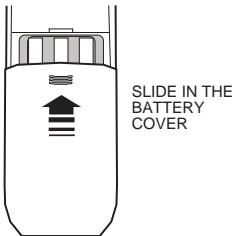

4. Place the Handset into the Base Unit cradle. Make sure the **CHARGING** light is illuminated. **Charge for at least 16 hours before first using the phone.** The Handset can charge face up or down.

SETTING UP YOUR VT 2931

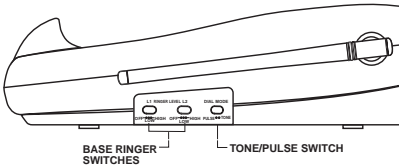

5. Set the **TONE/PULSE** switch, located on the antenna side of the Base Unit, to the desired dialing mode. In most areas, **TONE** is the desired mode.

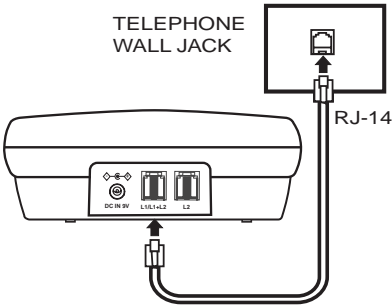

6. After charging the battery pack, connect the telephone line(s).

I. If you have 2 lines coming out of a single wall jack:

Connect a 4-wire (RJ-14) phone cord between the wall jack and the phone jack labeled **L1 / L1+L2**.

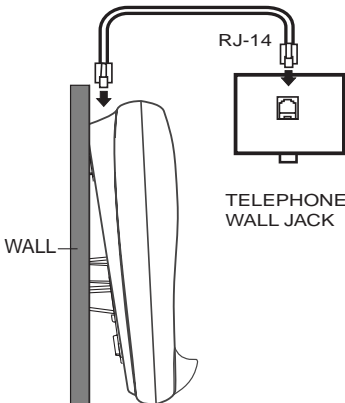

If you are wall mounting your Base Unit, a short, 4-wire phone cord is provided for your convenience.

II. If you have 2 lines, each coming out of a separate wall jack:

Connect a phone cord from the wall jack you wish to designate as your **LINE1**, to the **L1 / L1+L2** jack on the back of the phone; next, connect a phone cord from the remaining wall jack to the **L2** jack on the phone.

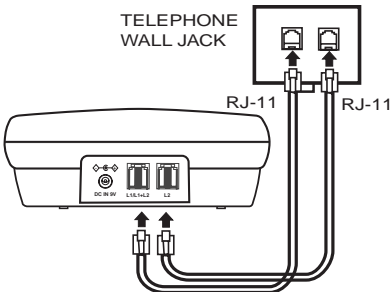

NOTE: You can use your **VT 2931** as a one-line phone, as well. For best results, raise the antenna on the Handset and Base Unit when using your telephone.

SETTING UP YOUR VT 2931

SPARE BATTERY CHARGER

The **VT 2931** has a built-in Spare Battery Charger, which is located in the cradle of the Base Unit. The spare Battery charger allows you to always have a charged battery pack available, in the event your Handset battery pack runs down.

NOTE: To obtain an optional Spare Battery, contact an authorized VTECH dealer, or by calling VTECH Customer Service at **1-800-595-9511** in the U.S.A and VTECH Electronics Canada Ltd at **1-800-267-7377** in Canada.

Installation

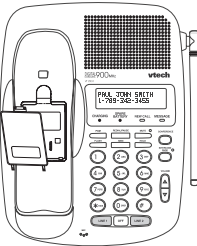

1. Remove the Spare Battery charger cover by pressing the release tab and lifting up.

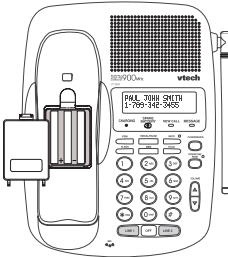

2. Place a battery pack in the Spare Battery charger. Make sure the metal charging contacts on the underside of the battery pack are aligned with the charging contacts in the Spare Battery charger.
3. The **SPARE BATTERY** LED will then be illuminated.

4. Close the spare battery cover.

Please note that the Spare Battery compartment charges at a slower rate than a battery pack charging in the Handset. It takes 24 hours to fully charge a battery pack in the Spare Battery charger.

WALL MOUNTING

The Wall Mounting bracket is designed to fit on standard Wall Mounting plates.

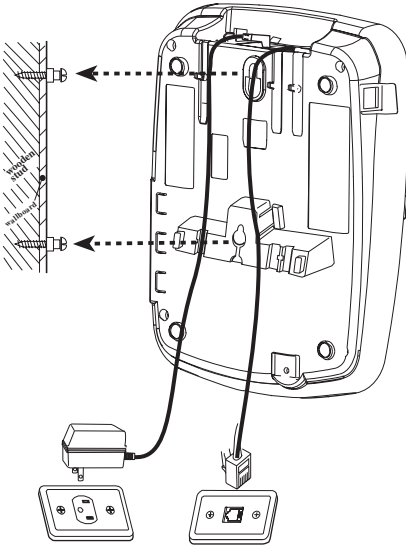

1. Choose a spot near an electrical outlet and a telephone jack.

Your phone requires a modular telephone jack and a standard electrical outlet (120v AC). The power cord is six feet long; make sure there is an electrical outlet within reach of the Base Unit. The outlet should not be controlled by a wall switch. If the switch is ever turned off, the phone will not operate.

2. Position the wall mount bracket on the base.

Line up the tabs on the wall mounting bracket with the holes on the bottom of the base. Snap the wall mounting bracket firmly into place.

3. Mount the base on the wall.

Position the base so the mounting studs will fit into the holes on the bottom of the base. Position the power cord to extend down the wall. Slide the base down on the mounting studs until it locks into place.

4. Connect the telephone line cord(s).

Insert one end of the telephone line cord(s) into the appropriate jacks on the back of the Base Unit, and the other end into the wall jack(s). For your convenience, a short line cord is provided.

5. Plug the AC adapter into an electrical outlet and the DC connector into the power jack located on the back of the Base Unit.

BASIC OPERATIONS



AREA CODE PROGRAMMING

To benefit from all the Caller ID features of your telephone, you must enter your home area code.

If you live in an area where you dial calls within your own area code by dialing 7 digits (no area code), follow these steps (with the Handset **OFF**):

1. Press **PROG.**
2. Press until **AREA** is blinking.
3. Press **SELECT.**
4. **HOME** should be blinking. If not, press until it blinks.
5. Press **SELECT.** **ENTER AREA CODE** is displayed.
6. Enter your own home area code.
7. Press **SELECT.**

ALTERNATE METHOD

If you live in an area where all local calls require 10 digits (area code plus phone number, without dialing "1" first):

1. Press **PROG.**
2. Press until **AREA** is blinking.
3. Press **SELECT.**
4. **HOME** should be blinking. If not, press until it blinks.
5. Press **SELECT.** **ENTER AREA CODE** is displayed.
6. Enter **000.**
7. Press **SELECT** and continue below.

You may program up to **5** local area codes. An area code is "local" if you do not dial "1" when you make calls to that area code. In other words, you make calls to "local" area codes by dialing 10 digits (area code plus phone number) without a preceding "1". This might include your own area code.

1. Press **PROG.**
2. Press until **AREA** is blinking.
3. Press **SELECT.**
4. Press until **LOCAL** is blinking.
Press **SELECT.**
5. Press until the desired location is blinking (**#1.....#5**).
6. Press **SELECT.** **ENTER AREA CODE** is displayed.
7. Enter a "local" area code.
8. Press **SELECT.**
9. Press **OFF** when finished.

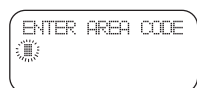



NOTE: To replace or edit an existing area code, use the key to delete the existing digits, and enter the desired area code. Press **SELECT** when done.

BASIC OPERATIONS

KEY BEEPS

Your Handset keys emit a beep as you press them. If you do not want to hear the beep, do the following while the Handset is not in use (on hook) :

1. Press **PROG**
2. Press  until **KEYBEEPS** is flashing
3. Press **SELECT**
4. Press  until **OFF** is flashing
5. Press **SELECT**





To turn the keybeep feature **ON** again, repeat steps 1 through 3. At the fourth step, press  until **ON** is flashing, then press **SELECT**.





SETTING RINGER

From the Handset

1. Press **PROG**.
2. Press  until **RINGER** is blinking
3. Press **SELECT**.
4. Press  or  to select **LINE1** or **LINE2**.
5. Press **SELECT**.



There are 4 ringer styles. The current setting is displayed.

6. Press  or  to hear the other ring styles OR turn the Handset ringer **OFF**.
7. When the desired ringer type is displayed, press **SELECT**.

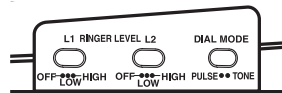

From the Base:

The Base Unit ringer is controlled by switches located on the right edge of the Base. Each line can be set to OFF, LOW, or HIGH volume.

MAKING CALLS

From the Handset:

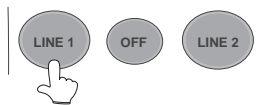

1. Press desired **LINE** key and listen for dial tone.
2. Dial the phone number. The Base Unit will display **HANDSET IN USE**, and the corresponding **LINE** key will blink.
3. Press **OFF** to end your call.

Alternate Method

1. Dial the phone number, checking the display for accuracy. If you make a mistake, use the  key to backspace.
2. Once you have entered the phone number, press the desired **LINE** key.
3. Press **OFF** to end your call.

BASIC OPERATIONS

From the Base Unit:



Press the desired **LINE** key and listen for dial tone. Dial the phone number. The corresponding **LINE** key on the Handset will blink. Press **OFF** to end your call.

REDIAL/PAUSE

From the Handset: Your **VT 2931** Handset remembers the last 5 phone numbers you dialed. With the Handset off, press **REDIAL/PAUSE**. The Handset will display:



R 1
18006245688

This is the last phone number dialed from the Handset. Press  or  to scroll through the previous numbers dialed. Once the desired number is displayed on the Handset, press the appropriate **LINE** key to dial.

From the Base Unit: Press **REDIAL/PAUSE**. The last number dialed from the Base Unit is displayed. Press the appropriate **LINE** key to dial.

ANSWERING CALLS

From the Handset:

1. Press the flashing **LINE** key. The **LINE** key will glow steadily and the Handset will display:



TALK
0:00' 00'

2. The Base Unit will display **HANDSET IN USE**, and the corresponding **LINE** key will blink.
3. Press **OFF** to end your call.

From the Base:

1. Press the flashing **LINE** key. The **LINE** key will glow steadily and the Base Unit will display:

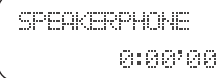

SPEAKERPHONE
0:00'00'

2. The corresponding **LINE** key on the Handset will blink while the Speakerphone is in use.
3. Press **OFF** to end your call.

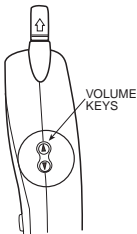



HANDSET VOLUME

Adjust the Handset volume with the  and  keys, located on the side of the Handset.

The Handset will display the relative volume level as you adjust it.

BASE SPEAKERPHONE VOLUME

Adjust the Base Unit volume with the  and  keys, located to the right of the dialpad. The Base will display the relative volume level as you adjust it. The Speakerphone volume can only be adjusted while the Base Unit is **IN USE** (in Speakerphone or Intercom mode).

MUTE

1. When you press the **MUTE** key while using the base speakerphone, you can hear your party's voice, but your party can't hear you.
2. While the call is muted, the **MUTE** indicator will be lit.
3. To go back to the two-way conversation, press **MUTE** again.



BASIC OPERATIONS

SPEAKERPHONE TIPS

If you use your Speakerphone in a noisy environment, the other person's voice may fade out. In this case, try eliminating the environmental noise (a television or radio playing, for example). Otherwise, press **MUTE** while the other person is speaking. Before you start to talk, press **MUTE** again so the other person can hear you.

CALL TIMER

While the Handset or Base is on a call, the corresponding display will show the approximate duration of that call. This is very helpful in monitoring long distance expenses.

HOLD

To place a call on hold, press **HOLD** on the Handset or Base, whichever you are using. **HOLD** will be displayed on the corresponding screen.

To return to your call, press the appropriate **LINE** key.

CALL WAITING

If you subscribe to Call Waiting, you will hear a tone while on the phone as you receive a second call. If you subscribe to Caller ID on Call Waiting, the Handset (or Base) will display who the second caller is before you answer.



FLASH



To answer Call Waiting, press **FLASH**. To return to your original call, press **FLASH** again. This procedure is the same for Handset and Speakerphone calls.

PAGING THE HANDSET

- To make the Handset ring, press **INTERCOM/PAGE** on the Base.
- To stop the ringing, press **OFF** on the Handset, or Base Unit.

INTERCOM

(Conversation between the Base and Handset)

From the Handset: Press **INTERCOM**. The Base Unit will ring, and the intercom call will be automatically connected.

From the Base:

1. Press **INTERCOM/PAGE**.
2. The Handset will ring. The Handset and Base Unit will display:
3. To answer the call, press **INTERCOM** on the Handset.
4. To end an Intercom call, press **OFF** on either the Handset or the Base.

** PAGING **

VOICE MAIL INDICATOR

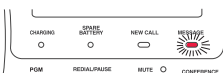

If you subscribe to Voice Mail, the **MESSAGE** light on the Base Unit will flash when you have new messages.

Once you have reviewed your new messages, the **MESSAGE** light will turn off.

BASIC OPERATIONS

VOICE MAIL TIPS:

After hearing your messages, wait until the Voice Mail indicators turn off before you make another call. This will ensure the indicators do not remain on after the messages are reviewed.

If, after reviewing all new voice messages, the Base Unit Voice **MESSAGE** indicator remains on, using the Handset, follow these steps:

- Press **PROG.**
- Press **#**. The Handset displays:
- With **LIGHT-OFF** flashing, press **SELECT**.



If you have new messages, but the Voice **MESSAGE** indicator does not turn on, ask your phone company to make sure your Voice Mail service has Visual Message Indication assigned.

IMPORTANT: If you move or change to a different telephone service provider, you should reset your Visual Message waiting feature:

1. Press **PROG** on the Handset
2. Press **#**
3. Press  so that **RESET** is blinking
4. Press **SELECT**.



CONFERENCE CALLING

To talk to both lines at the same time:

1. While you are on one line, press **HOLD**.
2. Make or receive a call on the available line.
3. Press **CONF** (or **CONFERENCE**). You are now talking to both lines.
4. To end your conference call, press **OFF**.

The procedure is the same for the Handset and Base. Whichever you are using, **CONFERENCE** is displayed on the screen.

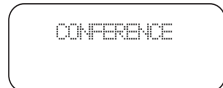

To place both lines on hold, press **HOLD**. Press **CONF** to return to the conference call. To switch from Handset to Base (or vice versa), press **HOLD** on whichever component you're using, then **CONF** on the other.

NOTE: Both the Handset and Base can join in the Conference call.

CALLER ID

This telephone provides two types of Caller ID on both the Handset and Base Unit:

Caller ID: Displays the name and number of each caller after the phone begins ringing (requires Caller ID service from your telephone company).

Caller ID on Call Waiting: Shows the name and number of each caller on Call Waiting after you hear the Call Waiting tone (requires Caller ID on Call Waiting service).

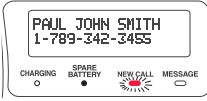

A **NEW CALL** light will flash on the Base Unit to alert you to new CID records. Once the new caller ID records have been reviewed on the Handset, the **NEW CALL** light will go out.

The phone has a Call Log, which stores the name, number, date, and time of the last 50 calls received. You can review the Call Log to see who called while you were out. You can speed-dial numbers from the Call Log. And you can store names and numbers from the Call Log into your directory.

NOTE: Caller ID and Call Waiting Caller ID are subscription services, available through most local phone service providers. You must subscribe to these services to benefit from the Caller ID features of this phone. Contact your local phone company for details.

REVIEWING THE CALL LOG

With the Handset OFF:

1. Press or . You will see the number of NEW (not viewed) and OLD (previously viewed) calls.
2. Continue to press or to review the callers.

Some locations are not equipped to send Caller ID information when a person places a call. When you receive calls from such locations, your phone will display **UNAVAILABLE**.

If a caller purposely blocks their phone number from being delivered by Caller ID, your phone will display **PRIVATE**.

HINT: If a * appears in the upper right corner, it indicates the party has called more than once.

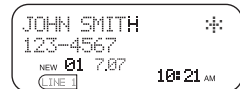

ERASING CALLS

To erase a call; with the Handset OFF:

- Press or until you see the call you want to erase.
- Press **SELECT**.
- Press until **ERASE** is blinking. Press **SELECT**.
- Press until **YES** is blinking. Then press **SELECT**.

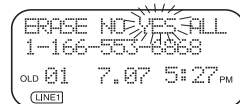

To erase your entire Call Log; after you have viewed all calls and the handset is off:

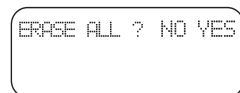

- Press or until you see any call in the log.
- Press **SELECT**.
- Press until **ERASE** is blinking. Press **SELECT**.
- Press until **ALL** is blinking.
- Then press **SELECT**. The handset displays:
- Press until **YES** is blinking. Then press **SELECT**.



DIRECTORY

SPEED DIALING FROM CALLER ID

With the Handset OFF:

- Press  or  until you see the desired caller.
- Press the desired line key. You will hear a dial tone, and the number will be dialed automatically.

TO STORE A NAME AND NUMBER

1. Press **PROG.** **DIRECTORY** will be blinking.
2. Press **SELECT**.
3. The screen will display **ENTER NAME**.



4. Use the Dialing keys to enter the desired name. Press the key until the desired letter or character appears. A guide to the characters:

KEY	CHARACTERS
1 _____	1
2 _____	A>B>C>2
3 _____	D>E>F>3
4 _____	G>H>I>4
5 _____	J>K>L>5
6 _____	M>N>O>6
7 _____	P>Q>R>S>7
8 _____	T>U>V>8
9 _____	W>X>Y>Z>9
0 _____	0
* _____	*
# _____	& ' , - . #

If consecutive characters are found on the same key (*D* and *E*, for example), you'll need to press  to advance to the next space. For example, to enter the name **DEAN**:

- Press **3** (**D**)
- Press 
- Press **3 twice** (**E**)
- Press **2** (**A**)
- Press **6 twice** (**N**)



5. When the name is complete, press **SELECT**. The screen will display:
6. Enter the phone number. Press **REDIAL/PAUSE** if you need to enter a 2-second pause in the dialing sequence. (For example, you might store a voice mail access number, pause, password.)
7. When the phone number is complete, press **SELECT** .

DIRECTORY

STORING A CALLER ID RECORD IN THE DIRECTORY

With the Handset **OFF**:

1. Press or until you see the desired call.
2. Press **SELECT** .
3. Press until **PGM** is blinking.
4. Press **SELECT** .

If you want to edit the name, press to erase letters. Use the dialpad to enter new letters. When the name is correct, press **SELECT**.

If you want to edit the number, press to erase digits. Use the dialpad to enter new digits. When the number is correct, press **SELECT**.

You will then hear a long beep. The name and number have been stored in the Directory.



MAKING DIRECTORY CALLS

1. Press **SELECT**. **DIRECTORY** will appear.
2. Press or to scroll to the desired name; *or*,
3. Search by entering the first letter of the name, and then press or if necessary.
4. Press the desired **LINE** key. You will hear a dial tone, and the number will be dialed.

DIRECTORY

DEAN
123456789

EDITING A DIRECTORY ENTRY

1. Press **SELECT** . The Handset says **DIRECTORY**.
2. Press or to scroll to the desired name; *or*, Search by entering the first letter of the name, and then press or if necessary.
3. Press **SELECT** .
4. Press until **EDIT** is blinking.
5. Press **SELECT** .The name appears.
6. If you want to edit the name, press to erase letters. Use the dialpad to enter new letters. When the name is correct, press **SELECT**.
7. The number appears. If you want to edit the number, press to erase digits. Use the dialpad to enter new digits. When the number is correct, press **SELECT**.

DIAL EDIT ERASE
12345678

ERASING A DIRECTORY ENTRY

1. Press **SELECT**.
2. Press or to scroll to the desired name; *or*, Search by entering the first letter of the name, and then press or if necessary.
3. Press **SELECT** .
4. Press until **ERASE** is blinking.
5. Press **SELECT**. Press until **YES** is blinking.
6. Press **SELECT**.



BASE UNIT OPERATION

PROGRAMMING SPEED DIAL NUMBERS



1. Press **PGM**. The Base will display:

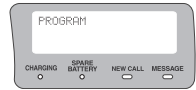

2. Press **MEM**. The Base will display :



3. Enter desired Location (**0-9**).
The Base will display:



4. Use the Base dial pad to enter the letters (16 characters maximum).

See: **DIRECTORY - TO STORE A NAME AND NUMBER** for a guide to the characters.

To enter 2 characters located on the same key, or, to add a space, use the **VOLUME ▲** key. To backspace, press the **VOLUME ▼** key.

For example, to enter the name 'DEAN':

- Press 3
- Press **VOLUME ▲**
- Press 3 twice
- Press 2
- Press 6 twice
- Press **PGM** when you finish entering the name. The Base will display:



- Enter the telephone number you wish to store (32 digits maximum).
- Press **PGM**. You will hear a confirmation beep, and the screen will go blank.

STORING A PAUSE IN A DIALING SEQUENCE

To insert a pause while programming a speed dial number, press **REDIAL/PAUSE** at the appropriate point in the number sequence. This inserts a 2 second pause. A "P" appears in the display representing the pause. For longer pauses, press **REDIAL/PAUSE** two or more times. Each pause is treated as a stored digit.

SPEED DIALING

- Press **LINE 1** or **2**.
- Press **MEM**. Enter Location (**0-9**).
- Press **OFF** to end your call.

BASE UNIT OPERATION

BASE DISPLAY

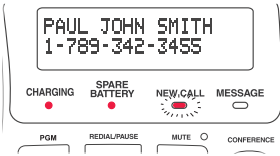

- CHARGING:** illuminates when the Handset is cradled.
- SPARE BATTERY:** illuminates when a battery Pack is charging in the Base Unit charger.
- NEW CALL:** flashes when new Caller ID records have been received.
- MESSAGE:** flashes when new Voice Mail messages are present.

DATA PORT

Your **VT 2931** has a Data Port on the left-hand edge of the Base Unit. This port provides an easy way to connect your fax machine, laptop computer, modem, or other telephone device for direct access to **LINE2**.

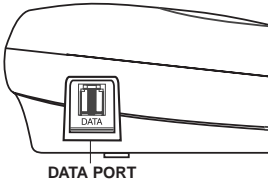

The Data Port only provides access to Line 2, so you must have an active line connected to the **LINE2** input on the back of the **VT 2931**. Connect an RJ-11(2-element) phone cord from the Data Port to your fax, laptop, etc.

NOTE: While the Data Port is in use, accidental use of Line 2 by a parallel phone, the **VT 2931** Handset, or a Call Waiting ID alert may interrupt the data transmission.

HEADSET OPERATION

Your **VTech** cordless phone is equipped with a 2.5mm Headset Jack for use with an optional accessory Headset for hands-free operation.

If you choose to use the Headset option, you must obtain an optional accessory Headset, which is compatible with the **VTech** cordless phone.

To purchase a Headset, call VTech Customer Service at 1-800-595-9511.
In Canada, call **VTECH** Electronics at 1-800-267-7377.

Once you have a compatible 2.5mm Headset, locate the Headset Jack on the **VTech** cordless phone Handset. Connect the plug on the Headset cord to the jack on the cordless Handset. The plug should fit securely. Do not force the connection.

OPERATION

NOTE: Whenever a compatible Headset is connected to the cordless Handset, the microphone on the Handset will be muted. This is done to limit the effect of background noise.

The following operational characteristics also apply to other headsets which are not sold by **VTech**; however, **VTech** assumes no responsibility for their performance.

The **VTech** compatible Headset has a reversible, monaural design. You can wear your Headset on either ear, leaving one ear free for room conversation.

The headband can be adjusted to fit the contour of your head. Using both hands, slide the headband up or down so that it rests comfortably on your head, with the speaker cushion centered against your ear.

For maximum sound quality, the flexible microphone should be positioned at the corner of your mouth, about one inch from your face.

BELT CLIP

The **VTech** cordless phone is also equipped with a detachable belt clip. Align the pins on the inside edge of the clip with the notches on the sides of the **VTech** cordless phone Handset. The belt clip should snap securely into place. Do not force the connection.

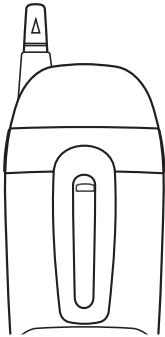
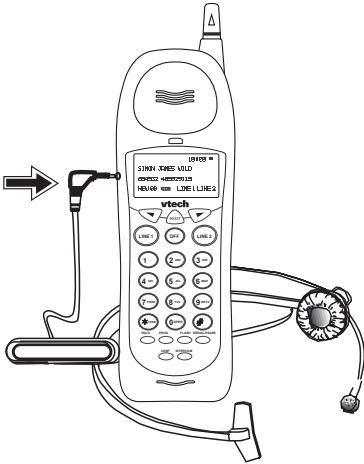

MAINTENANCE

Your **VT 2931** cordless telephone contains sophisticated electronic parts, so it must be treated with care.

Avoid rough treatment

Please place the Handset down gently. Save the original packing materials to protect your telephone if you ever need to ship it.

Avoid water

Your telephone can be damaged if it gets wet. Do not use the Handset outdoors in the rain, or handle it with wet hands. Do not install your Base Unit near a sink, bathtub or shower.

Electrical storms

Electrical storms can sometimes cause power surges harmful to electronic equipment. For your own safety, use caution when using electric appliances during storms.

Cleaning your telephone

Your telephone has a durable plastic casing that should retain its luster for many years. Clean it only with a soft cloth slightly dampened with water or a mild soap. Do not use excess water or cleaning solvents of any kind.

Remember that electrical appliances can cause serious injury if used when you are wet or standing in water. If your Base Unit should fall into water, **DO NOT RETRIEVE IT UNTIL YOU UNPLUG THE POWER CORD AND TELEPHONE LINE CORDS FROM THE WALL.** Then pull the unit out by the unplugged cords. If you have difficulty operating your phone, the suggestions below should solve the problem. If you still have difficulty after trying these suggestions, call **VTECH** Communications at 1-800-595-9511. In Canada, call VTECH Electronics at 1-800-267-7377.

IN CASE OF DIFFICULTY

THE PHONE DOESN'T WORK AT ALL.

- Make sure the Power Cord is plugged in.
- Make sure the telephone line cords are plugged firmly into the base unit and the telephone wall jack.
- Make sure the batteries are properly charged. If the 'LOW BATTERY' message is shown, the battery pack needs charging.

NO DIAL TONE.

- First check all the suggestions above.
- If you still don't hear a dial tone, disconnect the base unit from the telephone jack and connect a different phone. If there is no dial tone on that phone either, the problem is in your wiring or local service. Call your local telephone company.

YOU GET NOISE, STATIC, OR A WEAK SIGNAL EVEN WHEN YOU'RE NEAR THE BASE UNIT.

- Household appliances plugged into the same circuit as the base unit can sometimes cause interference. Try moving the appliance or the base unit to another outlet.

YOU GET NOISE, STATIC, OR A WEAK SIGNAL WHEN YOU'RE AWAY FROM THE BASE UNIT.

- You may be out of range. Either move close to the base, or relocate the base unit.
- The layout of your home may be limiting the range. Try moving the base unit to another position.

THE HANDSET DOES NOT RING WHEN YOU RECEIVE A CALL.

- Make sure you have the handset ringer activated. To set the ringer, see "**SETTING THE HANDSET RINGER**".
- Make sure the telephone line cord is plugged firmly into the base unit and the telephone jack. Make sure the power cord is plugged in.
- You may be too far from the base unit.
- You may have too many extension phones on your telephone line to allow all of them to ring. Try unplugging some of the other phones.

YOU HEAR OTHER CALLS WHILE USING YOUR PHONE.

- Disconnect your base unit from the telephone jack, and plug in a regular telephone. If you still hear other calls, the problem is probably in your wiring or local service. Call your local telephone company.

IN CASE OF DIFFICULTY

YOU HEAR NOISE IN THE HANDSET, AND NONE OF THE KEYS OR BUTTONS WORK.

Make sure the power cord is plugged in.

COMMON CURE FOR ELECTRONIC EQUIPMENT

Electronics, like people, can sometimes get confused. If the unit does not seem to be responding normally, then try putting the handset in the cradle. If it does not seem to respond after trying this a few times, do the following (in the order listed):

1. Disconnect the power to the base.
2. Disconnect (remove) the handset battery pack.
3. Remove the base unit battery pack, where applicable.
4. Wait a few minutes.
5. Connect power to the base.
6. Install the handset battery pack.
7. Install the base unit battery pack, where applicable.
8. Place the handset in the base unit cradle. If the handset has not been recently charged, allow 8 hours before use.

WARRANTY STATEMENT

WHAT DOES OUR WARRANTY COVER?

- Any defect in material or workmanship.

FOR HOW LONG AFTER THE ORIGINAL PURCHASE?

- To the original purchaser only - ONE YEAR.

WHAT WILL VTECH DO?

- At our option, repair or replace your unit.

HOW DO I SEND MY UNIT, IN OR OUT OF WARRANTY?

- Call VTECH Communications customer service for Return Authorization at:
1-800-595-9511
in Canada, call VTECH Electronics at:
1-800-267-7377.
- Properly pack your unit. Include any cables & accessories which were originally provided with the product. We recommend using the original carton and packing materials.
- Include in the package a copy of the sales receipt or other evidence of date of original purchase (if the unit was purchased within the last twelve months).
- Print your name and address, along with a description of the defect, and include this in the package.
- Include payment for any service or repair not covered by warranty, as determined by VTECH Communications.
- Ship the unit via UPS Insured, or equivalent to:

VTECH COMMUNICATIONS

11035 SW 11th St.
Bldg . B Suite 270
BEAVERTON, OREGON 97005

In Canada, ship the unit via UPS Insured, or equivalent to:

VTECH ELECTRONICS

Suite 200- 7671 Alderbridge Way
Richmond, B.C. V6X 1Z9

VTECH Communications assumes no responsibility for units sent without prior Return Authorization.

WHAT DOES OUR WARRANTY NOT COVER?

- Batteries
- Damage from misuse, neglect, or acts of nature (lightning, floods, power surges, etc.)
- Products which may have been modified or incorporated into other products.
- Products purchased and/or operated outside the USA, its territories, or Canada.
- Products serviced by the owner or a service facility not expressly authorized by VTECH Communications.
- Products purchased more than 12 months from current date.
- Units purchased in "AS IS" condition, or units purchased as "Distressed Merchandise".

HOW DOES STATE LAW OR PROVINCE LAW RELATE TO THIS WARRANTY?

- This warranty gives you specific rights. You may also have other rights which vary from state to state or from province to province.

FCC AND IC REGULATIONS

This equipment complies with Parts 15 and 68 of the Federal Communications Commission (FCC) rules for the United States. It also complies with regulations RSS210 and CS-03 of Industry and Science Canada. Operation is subject to the following two conditions: (1) this device may not cause interference, and (2) this device must accept any interference, including interference that may cause undesired operation of the device.

A label is located on the underside of the base unit containing either the FCC registration number and Ringer Equivalence Number (REN) or the IC registration number and Load Number. You must, upon request, provide this information to your local telephone company.

This equipment is compatible with inductively coupled hearing aids.

Should you experience trouble with this telephone equipment, please contact:

VTECH COMMUNICATIONS

SERVICE DEPT. at 1-800-595-9511.

In Canada, call VTECH Electronics at 1-800-267-7377.

For repair/warranty information. The telephone company may ask you to disconnect this equipment from the line network until the problem has been corrected.

FCC Part 15

Warning: Changes or modifications to this unit not expressly approved by the party responsible for compliances could void the user's authority to operate the equipment.

The equipment has been tested and found to comply with part 15 of the FCC rules. These limits are designed to provide reasonable protection against harmful interference in a residential installation. This equipment generates, uses and can radiate radio frequency energy and, if not installed and used in accordance with the instructions, may cause harmful interference to radio communications. However, there is no guarantee that interference will not occur in a particular installation. If this equipment does cause harmful interference to radio or television reception, which can be determined by turning the equipment off and on, the user is encouraged to try and correct the interference by one or more of the following measures:

- Reorient or relocate the receiving antenna.
- Increase the separation between the equipment and receiver.
- Connect the equipment into an outlet or on a circuit different from that to which the receiver is connected.
- Consult the dealer or an experienced radio/TV technician for help.

FCC Part 68

The FCC requires that you connect your cordless telephone to the nationwide telephone network through a modular telephone jack (USOC RJ11C, RJ11W or RJ14).

Your telephone company may discontinue your service if your equipment causes harm to the telephone network. They will notify you in advance of disconnection, if possible. During notification, you will be informed of your right to file a complaint with the FCC.

Occasionally, your telephone company may make changes in its facilities, equipment,

FCC AND IC REGULATIONS

operation, or procedures that could affect the operation of your equipment. If so, you will be given advance notice of the change to give you an opportunity to maintain uninterrupted service.

The base unit contains no user serviceable parts. The handset contains a user replaceable battery pack.

If it is determined that your telephone equipment is malfunctioning, the FCC requires that it not be used and that it be unplugged from the modular jack until the problem has been corrected. Repairs to this telephone equipment can only be made by the manufacturer or its authorized agents or by others who may be authorized by the FCC. For repair procedures, follow the instructions outlined under the manufacturer's Limited Warranty.

This equipment may not be used on coin service provided by the phone company or Party Lines.

The REN is useful in determining the number of devices you may connect to your telephone line and still enable the devices to ring when you receive a call. The general rule is that the REN value should not exceed 5.0 total; however, contact your local telephone company for the specific number in your area.

IC (Industry Canada)

This telephone is registered for use in Canada.

Notice: The REN assigned to this device denotes the number of devices you may connect to the telephone loop, which is used by the device to prevent overloading. The termination on a loop may consist of any combination of devices subjected only to the requirement that the sum of the REN does not exceed five (5.0)

Notice: The Industry Canada label identifies certified equipment. This certification means that the equipment meets certain telecommunications network protective, operational and safety requirements. The Department does not guarantee the equipment will operate to the user's satisfaction.

Before installing this equipment, users should ensure that it is permissible to be connected to the facilities of the local telecommunications company. The equipment must also be installed using an acceptable method of connection. The customer should be aware that compliance with the above conditions may not prevent degradation of services in some situations.

Repairs to certified equipment should be made by an authorized Canadian maintenance facility designated by the supplier. Any repairs or alterations made by the user to this equipment, or equipment malfunctions, may give the telecommunications company cause to request the user to disconnect the equipment.

Users should ensure for their own protection that the electrical ground connections of the power utility, telephone lines and internal metallic water pipe system, if present, are connected together. This precaution may be particularly important in rural areas.

Caution: Users should not attempt to make such connections themselves, but should contact the appropriate electrical inspection authority, or electrician, as appropriate.

FCC AND IC REGULATIONS

Your VT 2931 is designed to operate at the maximum power allowed by the FCC . This means your handset and base unit can communicate only over a certain distance - which will depend on the location of the base unit and handset, weather, and the construction and layout of your home or office.

THE RBRC™ SEAL



The RBRC® Seal on the nickel-cadmium battery contained in our product indicates that VTech Communications, Inc. is voluntarily participating in an industry program to collect and recycle these batteries at the end of their useful lives, when taken out of service within the United States and Canada.

The RBRC® program provides a convenient alternative to placing used nickel-cadmium batteries into the trash or municipal waste, which may be illegal in your area.

VTech's participation in RBRC® makes it easy for you to drop off the spent battery at local retailers participating in the RBRC® program or at authorized VTech product service centers. Please call **1-800-8-BATTERY™** for information on Ni-Cd battery recycling and disposal bans/restrictions in your area. VTech's involvement in this program is part of its commitment to protecting our environment and conserving natural resources.

Remove the nickel-cadmium battery pack by pressing on the Handset battery cover and sliding downward.

RBRC® is a registered trademark of Rechargeable Battery Recycling Corporation.

TECHNICAL SPECIFICATIONS

FREQUENCY CONTROL

Crystal Controlled Dual PLL Synthesizer

TRANSMIT FREQUENCY

Handset : 923.10 MHz to 927.75 MHz (All ten channels within this range)

Base : 902.3 MHz to 906.65 MHz (All ten channels within this range)

RECEIVE FREQUENCY

Handset : 902.3 MHz to 906.65 MHz (All ten channels within this range)

Base : 923.10 MHz to 927.75MHz (All ten channels within this range)

NOMINAL EFFECTIVE RANGE

Maximum power allowed by FCC and IC. Actual operating range may vary according to environmental conditions at the time of use.

SIZE

Handset : 17.5 x 6 x 4.5cm (L x W xT)
Maximum (Antenna excluded)

Base : 20.5 x 17x 70cm (L x W x T) Maximum (Antenna excluded)

WEIGHT

Handset : 205 grams
Base : 570 grams

POWER REQUIREMENTS

Handset : Self-contained nickel-cadmium rechargeable battery supply, 3.6V nominal, 600mAh capacity.

Base : 9VDC @ 550mA

MEMORY

DIRECTORY : 50 Memory locations, 32 digits and 16 letters per location.

CID : Alpha Numeric Display 50 Memory locations

SPECIFICATIONS ARE TYPICAL AND MAY CHANGE WITHOUT NOTICE.

vtech

VTECH TELECOMMUNICATIONS LTD.



A member of THE VTECH GROUP OF COMPANIES.

Distributed in the U.S.A. by VTech Communications Inc, Beaverton, Oregon, 97008

Distributed in the Canada by VTech Electronics Canada Ltd., Suite 200-7671 Alderbridge Way Richmond, B.C. V6X 1Z9.

Copyright 2000 for VTECH TELECOMMUNICATIONS LTD.
Printed in China

91-5124-20-00
ISSUED 0

DIGITAL
CORDLESS 900MHz

VT 2931

vtech

CHARGING

SPARE
BATTERY

NEW CALL

MESSAGE

PGM

REDIAL/PAUSE

MUTE

CONFERENCE

FLASH

MEM

HOLD

INTERCOM/
PAGE

1

2 ABC

3 DEF

4 GHI

5 JKL

6 MNO

VOLUME

7 PQRS

8 TUV

9 WXYZ

* TONE

0 ONE

#

LINE 1

OFF

LINE 2

MIC

CAUTION
USE ONLY
VTECH BATTERY
80-4314-00-00



PLEASE RECYCLE THIS PRODUCT
IN ACCORDANCE WITH THE
RECYCLING PROGRAMS IN YOUR
LOCALITY. SEE YOUR LOCAL
RECYCLING CENTER FOR
MATERIALS.



14

© 2004 Vtech Inc. All rights reserved.
Vtech Inc. is a registered trademark of Vtech Inc.
Vtech Inc. is a registered trademark of Vtech Inc.
Vtech Inc. is a registered trademark of Vtech Inc.
Vtech Inc. is a registered trademark of Vtech Inc.

Vtech



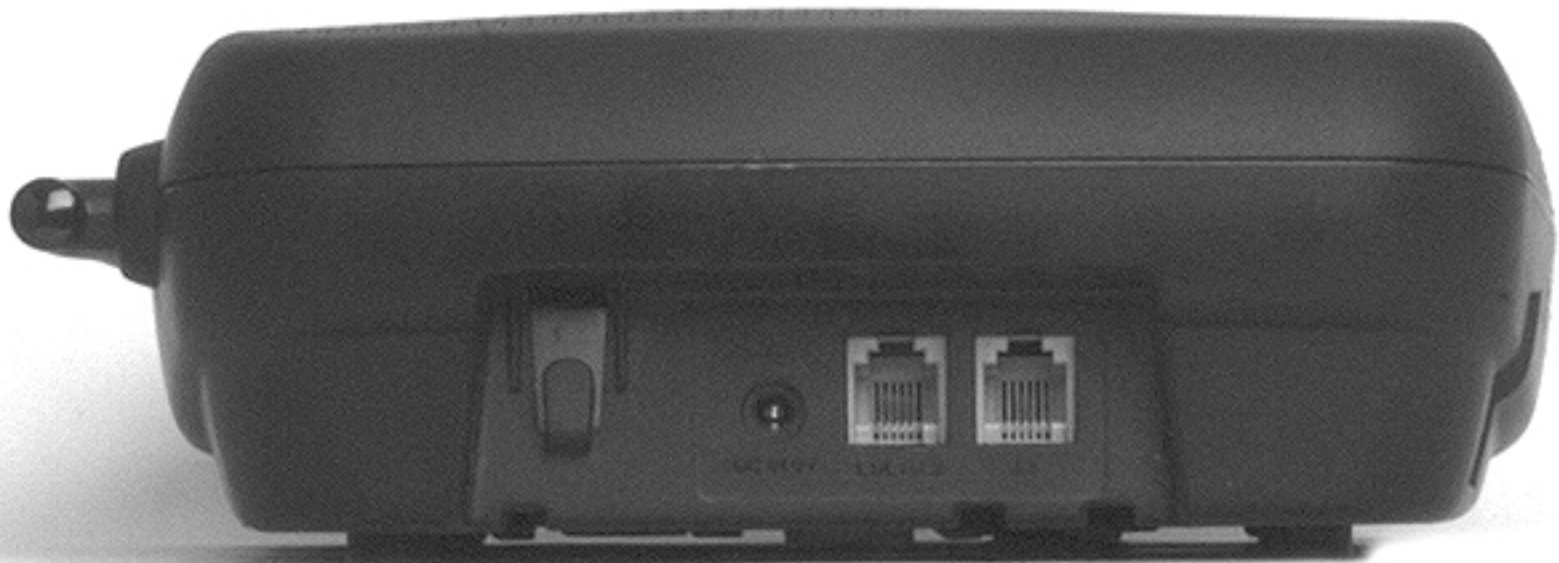

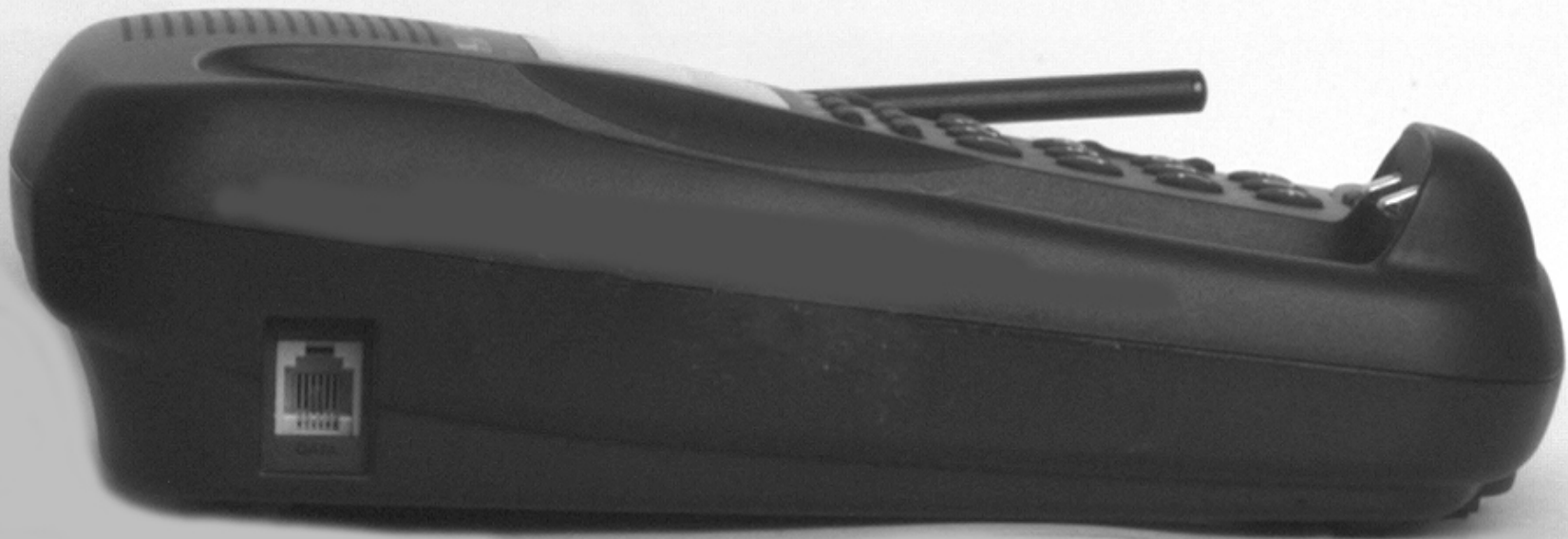





vtech

