

DAEWOO

MICROWAVE OVEN

KOG-3705

OPERATING
INSTRUCTIONS

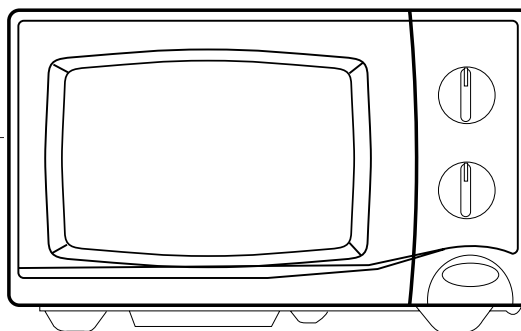

Before operating this oven, please read these instructions completely.

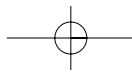

PRECAUTIONS TO AVOID POSSIBLE EXPOSURE TO EXCESSIVE MICROWAVE ENERGY

- (a) **Do not attempt to operate this oven with the door open** since open-door operation can result in harmful exposure to microwave energy. It is important not to defeat or tamper with the safety interlocks.
- (b) **Do not place any object** between the oven front face and the door or allow soil or cleaner residue to accumulate on sealing surfaces.
- (c) **WARNING** : If the door or door seals are damaged, the oven must not be operated until it has been repaired by a trained person : (1) door (bent), (2) hinges and latches(broken or loosened), (3) door seals and sealing surfaces.
- (d) **WARNING** : It is hazardous for anyone other than a trained person to carry out any service or repair operation which involves the removal of any cover which gives protection against exposure to microwave energy.
- (e) **WARNING** : Liquids or other foods must not be heated in sealed containers since they are liable to explode.
- (f) **WARNING** : Only allow children to use the oven without supervision when adequate instructions have been given so that the child is able to use the oven in a safe way and understands the hazards of improper use.

TABLE OF CONTENTS

PRECAUTIONS TO AVOID POSSIBLE EXPOSURE TO EXCESSIVE MICROWAVE ENERGY	1
TABLE OF CONTENTS	1
EARTHING INSTRUCTIONS	2
INSTALLATION	2
IMPORTANT SAFETY INSTRUCTIONS	3
FEATURES DIAGRAM	4
OPERATION	5
COOKING UTENSILS	5
CARE AND CLEANING	6
BEFORE YOU CALL FOR SERVICE	6
QUESTIONS AND ANSWERS	7
SPECIFICATIONS	7
IMPORTANT	7

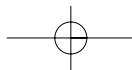

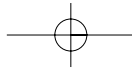

EARTHING INSTRUCTIONS

This appliance must be earthed. In the event of an electrical short circuit, earthing reduces the risk of electric shock by providing an escape wire for the electric current. This appliance is equipped with a cord having a earthing wire with a earthing plug. The plug must be plugged into an outlet that is properly installed and earthed.

WARNING: Improper use of the earthing plug can result in a risk of electric shock. Consult a qualified electrician or serviceman if the earthing instructions are not completely understood, or if doubt exists as to whether the appliance is properly earthed. If it is necessary to use an extension cord, use only a 3-wire extension cord that has a 3-blade earthing plug, and a 3-slot receptacle that will accept the plug on the appliance. The marked rating of the extension cord should be equal to or greater than the electrical rating of the appliance.

INSTALLATION

1 Steady, flat location

This oven should be set on a steady, flat surface. This oven is designed for counter top use only.

2 Leave space behind and side

All air vents should be kept a clearance. If all vents are covered during operation, the oven may overheat and, eventually, oven failure.

3 Away from radio and TV sets

Poor television reception and radio interference may result if the oven is located close to a TV, Radio antenna, feeder and so on.

Position the oven as far from them as possible.

4 Away from heating appliance and water taps

Keep the oven away from hot air, steam or splash when choosing a place to position it, or the insulation might be adversely affected and breakdowns occur.

5 Power supply

- Check your local power source. This oven requires a current of approximately 11 amperes, 230V 50Hz.
- Power supply cord is about 0.8 meters long.
- The voltage used must be the same as specified on this oven. Using a higher voltage may result in a fire or other accident causing oven damage. Using low voltage will cause slow cooking. We are not responsible for damage resulting from use of this oven with a voltage of ampere fuse other than those specified.
- If the supply cord is damaged, it must be replaced by the manufacturer or its service agent or a similarly qualified person in order to avoid a hazard.

6 Examine the oven after unpacking for any damage such as:

A misaligned door, Broken door, A dent in cavity. If any of the above are visible, DO NOT INSTALL, and notify dealer immediately.

7 Do not operate the oven if it is colder than room temperature.

(This may occur during delivery in cold weather.) Allow the oven to become room temperature before operating.

8 The minimum height of free space necessary above the top surface of the oven is 100mm.

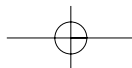

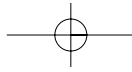

IMPORTANT SAFETY INSTRUCTIONS

WARNING:To prevent fire, burns, electric shock and other warnings:

Listed below are, as with all appliances, certain rules to follow and safeguards to assure high performance from this oven:

1. Do not use the oven for any reason other than food preparation, such as for drying clothes, paper, or any other nonfood items or for sterilizing purposes.
2. Do not use the oven when empty, this could damage the oven.
3. Do not use the oven cavity for any type of storage, such as papers, cookbook, cookware, etc.
4. Do not operate the oven without the glass tray in place. Be sure it is properly sitting on the rotating base.
5. Make sure you remove caps or lids prior to cooking when you cook food sealed in bottles.
6. Do not put foreign material between the oven surface and door. It could result in excessive leakage of microwave energy.
7. Do not use recycled paper products for cooking. They may contain impurities which could cause sparks and/or fires when used during cooking.
8. Do not pop popcorn unless popped in a microwave approved popcorn popper or unless it's commercially packaged and recommended especially for microwave ovens. Microwave popped corn produces a lower yield than conventional popping; there will be a number of unpopped kernels. Do not use oil unless specified by the manufacturer.
9. Do not cook any food surrounded by a membrane, such as egg yolks, potatoes, chicken livers, etc., without first piercing them several times with a fork.
10. Do not pop popcorn longer than the manufacturer's directions. (popping time is generally below 3 minutes).
Longer cooking does not yield more popped corn, it can cause scorchings and fire.
Also, the cooking tray can become too hot to handle or may break.
11. If smoke is observed, switch off or unplug the appliance and keep the door closed in order to stifle any flames.
12. When heating food in plastic or paper containers, check the oven frequently due to the possibility of ignition.
13. The contents of feeding bottles and baby food jars are to be stirred or shaken and the temperature is to be checked before consumption, in order to avoid burns.
14. Always test the temperature of food or drink which has been heated in a microwave oven before you give it to somebody, especially to children or elderly people. This is important because things which have been heated in a microwave oven carry on getting hotter even though the microwave oven cooking has stopped.
15. Eggs in their shell and whole hard-boiled eggs shall not be heated in microwave ovens since they may explode.
16. Keep the waveguide cover clean at all times. Wipe the oven interior with a soft damp cloth after each use. If you leave grease or fat anywhere in the cavity it may overheat, smoke or even catch fire when next using the oven.
17. Never heat oil or fat for deep frying as you cannot control the temperature and doing so may lead to overheating and fire.
18. Microwave heating of beverages can result in delayed eruptive boiling, therefore care has to be taken when handling the container.
19. a) Be cautions about touching parts other than control panel during or immediately following grill or combi cooking.
b) Always use hot pads or oven mitts when placing or removing food and/or accessories from the oven.

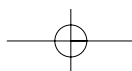

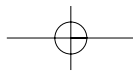

FEATURES DIAGRAM

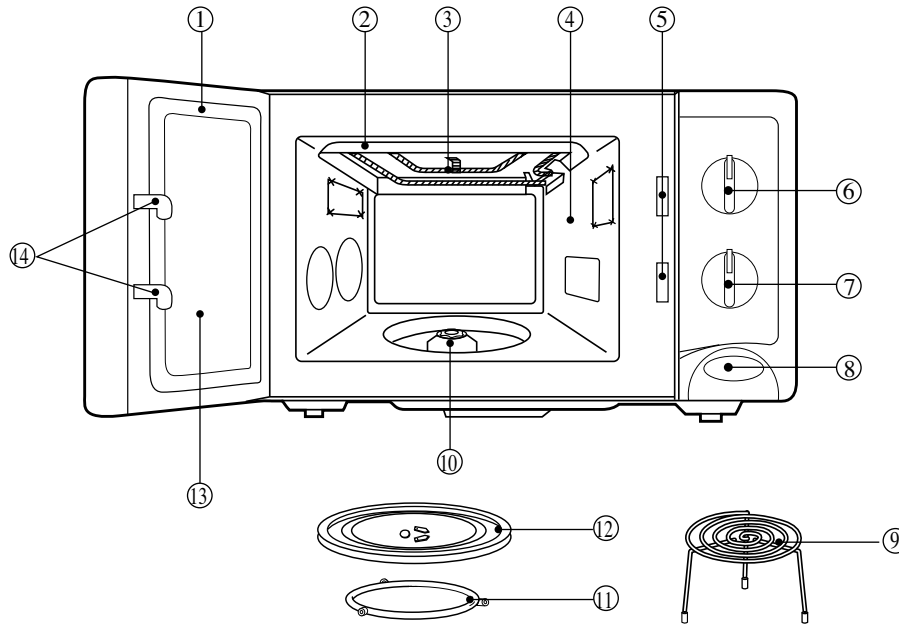

1. **Door seal** - Door seal maintains the microwave energy within the oven cavity and prevents microwave leakage.
2. **Reflector** (Insulator Heater)
3. **Heating Element**
4. **Oven cavity**
5. **Safety interlock system**
6. **Knob V.P.C** - Used to select a microwave power level.
7. **Knob timer** - Used in setting cooking time for all functions.
8. **Door release button** - By pushing this button the latch system cut off all circuits and stops the oven before the door is opened.
9. **Metal Rack**
10. **Coupler** - This fits over the shaft in the center of the ovens cavity floor. This is to remain in the oven for all cooking.
11. **Roller guide** - This must always be used for cooking together with the glass cooking tray.
12. **Glass cooking tray** - Made of special heat resistant glass. Food in a proper receptacle is placed on this tray for cooking.
13. **Door viewing screen** - Allows viewing of food. The screen is designed so that light can pass through, but not the microwave.
14. **Door hook** - When the door is closed, it will automatically shut off. If the door is opened while the oven is operating, the magnetron will immediately stop operating.

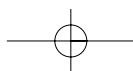

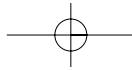

OPERATION

- 1 Connect the mains lead to an electrical outlet.
- 2 After placing the food in a suitable utensil, open the oven door and put it on the glass tray. Glass tray must always be in place during cooking.
- 3 Shut the door.
Make sure that it is firmly closed.
- 4 How to set each function
To set MICROWAVE cooking
* Set the variable power selector to the desired power level.

SYMBOL	POWER LEVEL	OUTPUT POWER
☼☼	DEFROST	33%
610W	MED-HIGH	77%
MAX	HIGH	100%

To set GRILL cooking

- * Set the POWER SELECTOR to the ☼ (grill) position.

To set COMBI cooking

- * Set the POWER SELECTOR to the ☼☼ (combi) position.

- 5 Set the time control by turning the timer knob and then microwave cooking starts.
 - If turning the timer knob for less than 2 minutes, turn it past 2 minutes and then back to the desired time.
 - During the same time, the rotating angle of the timer knob of the period from 35 to 10 minute is smaller than that of the period from 10 to 0 minute owing to the dual speed of the timer motor.
- 6 Microwave energy will be turned off automatically when the timer point to "OFF".
Then take out foods.
 - To prevent the oven operating with the door open, your microwave oven is fitted with safety door interlock switches. If you wish to inspect the food during the cooking time, simply open the door. The oven will automatically stop cooking.
To continue cooking, you simply close the door.
 - If you wish to stop cooking during the cooking, simply turn the timer knob the point "OFF".
Cooking can be reset at any time during the cooking cycle by only turning the timer knob.
 - Do not let the timer continue to operate after removing food.
- 7 NOTE : When using the GRILL or COMBI mode;
 - Do not open the door so often, the temperature inside the oven decrease and the cooking may not be completed in setting time.
 - Never touch the oven window and metal interior of the oven when taking food in and out, because the temperature inside the oven and door is very high.
 - When using these modes, be careful as the tray will be hot to touch, use oven gloves or pot holders while handling tray.

COOKING UTENSILS

Utensils should be checked to ensure that they are suitable for use in microwave ovens. Microwave energy is produced by high frequency radio waves. They are reflected from metal, but will pass through most cooking utensils without heating them.

As the waves come into contact with the food, they are converted into heat energy. Listed below are the suggested cooking utensils for this microwave oven and when to use them.

Before use, the user should check that utensils are suitable for use in microwave ovens.

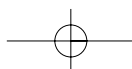

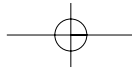

Material	Grill cooking	Microwave cooking	Combined cooking
Glass (general)	No	Yes(1)	No
Glass (heat resistant)	Yes	Yes	Yes
Glass-ceramic and ceramic (heat resistant)	Yes	Yes(1)	Yes(1)
Earthenware	Yes	Yes	Yes
China (heat resistant)	Yes	Yes	Yes
Plastic (general)	No	Yes(2)	No
Plastic (heat resistant)	Yes(2)	Yes(2)	Yes(2)
Aluminum foil containers/ Aluminum foil	Yes	Yes(3)	Yes
Metal baking tins	Yes(4)	No	Yes(4)
Metal (pots, pans, etc.)	Yes	No	No
Paper	No	Yes	No

1. Without metal parts or metal trims.
 2. Some plastics are heat-proof only to certain temperature. Check carefully!
 3. It is possible to use aluminum foil to shield delicate areas of food.(This prevents over-cooking.)
 4. Metal tins can be used in the combination methods, however if these are very deep, they will greatly reduce the efficiency, as metal shields the microwave energy from the food.

CARE AND CLEANING

Although your oven is provided with safety features, it is important to observe the following:

1. It is important not to defeat or tamper with safety interlocks.
2. Do not place any object between the oven front face and the door or allow residue to accumulate on sealing surfaces. Wipe the sealing area frequently with a mild detergent, rinse and dry. Never use abrasive powders or pads.
3. When opened, the door must not be subjected to strain, for example, a child hanging on an opened door or any load could cause the oven to fall forward to cause injury and also damage to the door. Do not operate the oven if it is damaged, until it has been repaired by a trained service technician.
It is particularly important that the oven closes properly and that there is no damage to the:
 - i) Door(bent)
 - ii) Hinges and Hooks(broken or loosened)
 - iii) Door seals and sealing surfaces.
4. The oven should not be adjusted or repaired by anyone except a properly trained service technician.

BEFORE YOU CALL FOR SERVICE

Refer to the following checklist, you may prevent an unnecessary service call.

*** The oven doesn't work;**

1. Check that the power cord is securely plugged in.
2. Check that the door firmly closed.
3. Check that the cooking time is set.
4. Check for a blown circuit fuse or tripped main circuit breaker in your house.

*** Sparking in the cavity;**

1. Check that utensils are metal containers or dishes with metal trim.
2. Check that metal skewers touch the interior walls.

If there is still a problem, contact the service station.

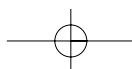

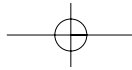

QUESTIONS AND ANSWERS

- * **Q** : I accidentally ran my microwave oven without any food in it. Is it damaged?
A : Running the oven empty for a short time will not damage the oven. However, it is not recommended.
- * **Q** : Can the oven be used with the glass tray or roller guide removed?
A : No. Both the glass tray and roller guide must always be used in the oven before cooking.
- * **Q** : Can I open the door when the oven is operating?
A : The door can be opened anytime during the cooking operation. Then microwave energy will be instantly switched off and the time setting will maintain until the door is closed.
- * **Q** : Why do I have moisture in my microwave oven after cooking?
A : The moisture on the side of your microwave oven is normal. It is caused by steam from cooking food hitting the cool oven surface.
- * **Q** : Does microwave energy pass through the viewing screen in the door?
A : No. The metal screen bounces back the energy to the oven cavity. The holes are made to allow light to pass through. They do not let microwave energy pass through.

SPECIFICATIONS

POWER SUPPLY		230V~50Hz, SINGLE PHASE WITH EARTHING
POWER CONSUMPTION	MICROWAVE	1200 W
	GRILL	1100 W
	COMBINATION	2200 W
MICROWAVE ENERGY OUTPUT		800W
MICROWAVE FREQUENCY		2450MHz
OUTSIDE DIMENSIONS (WXHXD)		465X279X360mm
CAVITY DIMENSIONS (WXHXD)		290X220X306mm
NET WEIGHT		APPROX. 13.4Kg
TIMER		35 min. DUAL SPEED
POWER SELECTIONS		5 LEVELS
CAVITY VOLUME		0.7 Cu.Ft.

* Specifications are subject to change without notice.

IMPORTANT

The wires in this mains lead are coloured in accordance with the following code.

Green-and-yellow : Earth
 Blue : Neutral
 Brown : Live

As the colours of the wires in the mains lead of this appliance may not correspond with the coloured markings identifying the terminals in your plug, proceed as follows:

The wire which is coloured green-and-yellow must be connected to the terminal in the plug which is marked with the letter 'E' or by the earth symbol or green-and-yellow. The wire which is coloured blue must be connected to the terminal which is marked with the letter 'N' or coloured black.

The wire which is coloured brown must be connected to the terminal which is marked with the letter 'L' or coloured red.

WARNING: This appliance must be earthed.

