

FAX-B140/B120/B115

User's Guide

1 SETTING UP

Unpacking

As you unpack your fax, save the carton and packing material in case you want to move or ship the fax in the future.

Carefully remove all items from the box.

- It is best to have someone hold the box while you lift the fax and its protective packaging out of the carton.

Make sure you have the following items:

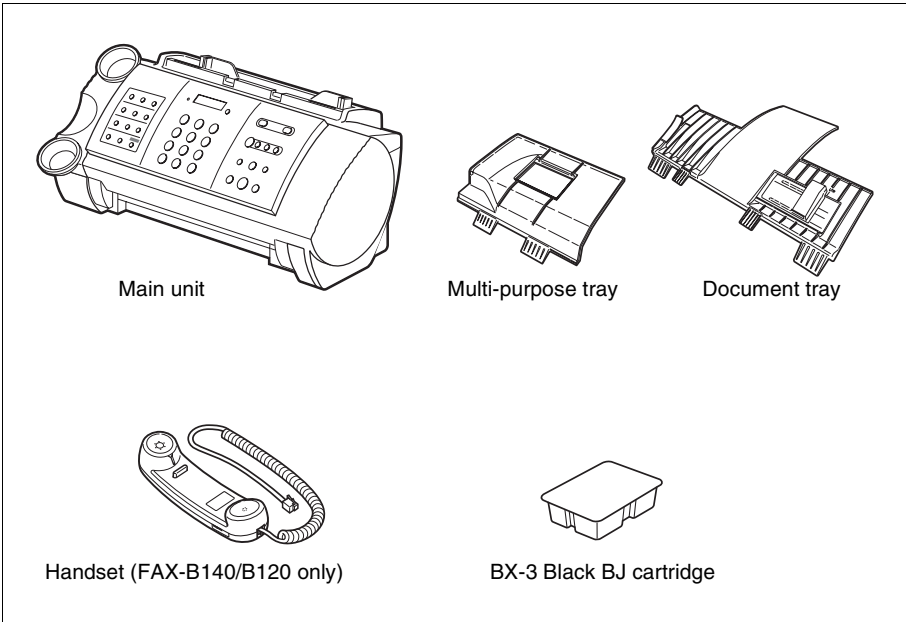

You should also have the followings:

- Power cord
- Telephone line cord
- B.T. adaptor (U.K. only)
- Documentation
- Warranty*
- One-touch sheet*

If any of these items are damaged or missing, contact your local authorised Canon dealer or the Canon help line immediately.

* These items are only included in some countries.

2 PREPARING TO USE YOUR FAX

Main components of your fax

2

PREPARING TO USE YOUR FAX

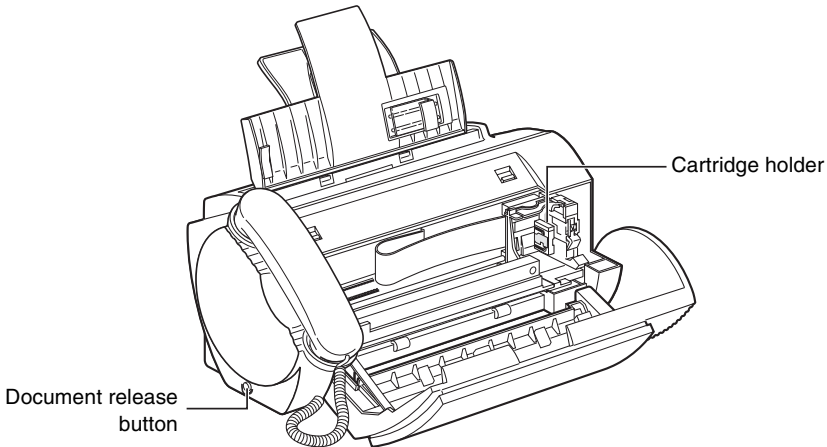
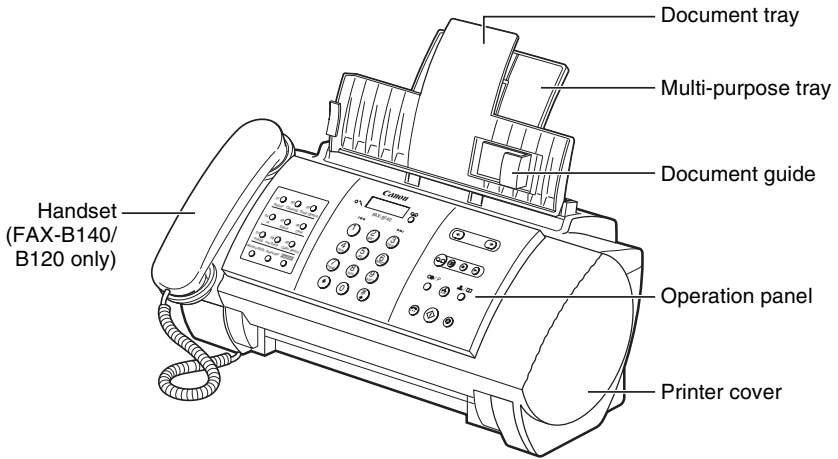

Please note that your fax may differ from the illustration above.

Note

3 DOCUMENTS AND PAPER

Types of documents you can scan

■ Size

The fax can scan standard A4-, letter-, or legal-size documents.

■ Scanned area

The actual area scanned by the fax is shown below.

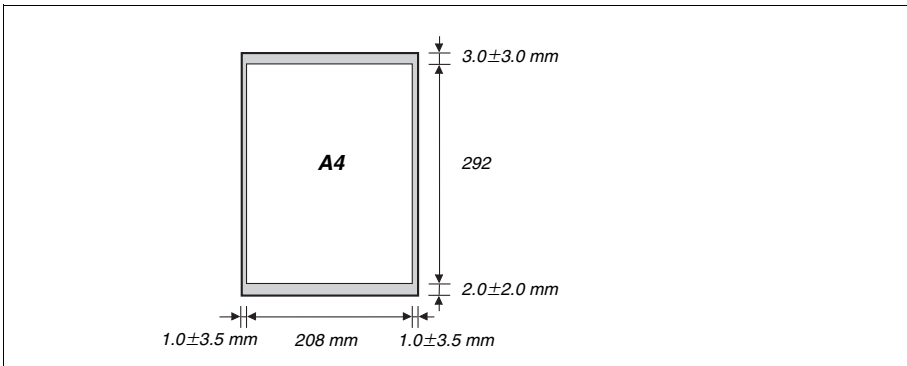

The margin on either side of the sheet and the margin on the top and bottom are not picked up by the scanner.

Problem documents

- To prevent document jams in the document tray, do not attempt to load the following types of document into the fax:
 - Wrinkled or creased paper
 - Torn paper
 - Coated paper or glossy paper
 - Thick paper
- Remove all staples, paper clips, etc. before loading the document into the document tray.
- Make sure any glue, ink or correction fluid on the paper is completely dry before loading the document into the document tray.
- Make a photocopy of any document that will not feed into the fax so that you can then load the copy into the document tray.

4 MAKING COPIES

Copying documents

One of the convenient features of the fax is its ability to make high quality copies. You can make up to 99 copies of one document at a time.

If you make copies of multiple documents at a time, the number of pages the fax can scan into memory varies depending on the scanning resolutions (see p. 5-1) as follows:

- STANDARD/FINE = 25 pages
- PHOTO = 1 page



- STANDARD and FINE result in the same resolution when making copies.
- If MEMORY FULL appears on the LCD when making multiple copies, see Copying problems, p. 9-13.

1 Load the document face up into the document tray.

See Loading documents, p. 3-2.

2 Press [Resolution].

You can select STANDARD/FINE or PHOTO.

COPY PAGE	01
-----------	----

▼
Press [Start/Copy].

3 Enter the number of copies (up to 99) using the numeric buttons.

To make a correction to the number of copies, press [Clear] and re-enter the number.

▼
Press [Start/Copy].

To stop copying anytime, press [Stop]. You may then need to press [Start/Copy] for a few seconds, then the fax will feed out the document. See Jams in the document tray, p. 9-1.

5 SENDING DOCUMENTS

Preparing to send a document

Before you send a document, see Chapter 3: DOCUMENTS AND PAPER.

Adjusting the quality of your documents _____

■ Setting the scanning resolution

Resolution is a measure of the fineness or clarity of a printout. Low resolutions may cause text and graphics to have a jagged appearance, while higher resolutions provide smoother curves and lines, crisp text and graphics, and a better match to traditional typeface designs.



Note

The higher the resolution, the higher the output quality, but the slower the scanning speed.

1 Load the document face up into the document tray.

See Loading documents, p. 3-2.

2 Press [Resolution] to select the resolution.

You can select STANDARD, FINE or PHOTO.

After about 5 seconds, the fax returns to standby mode.



Note

You can change the resolution setting while the document is being scanned for sending. However, please note that your new setting will only be effective from the next page scanned.

■ Setting the scanning contrast

Contrast is the difference in brightness between the lightest and darkest parts of a printed document. You can adjust the contrast your fax uses to send or copy documents, according to how light or dark your document is.

1 Press [Function].



Press [Start/Copy] twice.

DATE & TIME

2 Use [◀] or [▶] to select SCAN CONTRAST.



Press [Start/Copy].

STANDARD

3 Use [◀] or [▶] to adjust the scanning contrast.

You can select STANDARD, DARKER or LIGHTER.



Press [Start/Copy].

4 Press [Stop].

Setting ends and the fax returns to standby mode.

6 RECEIVING DOCUMENTS

Different ways to receive a document

Your fax provides you with several modes for receiving documents. To determine which mode best suits your requirements, see the table below.

Receive Mode	Main Use	Operation	Requirements	Details
FAX ONLY MODE	Fax	Answers all calls as fax calls. Receives documents automatically and disconnects voice calls.	Separate telephone line for fax use only. If you want to be alerted when a fax call is received, connect the handset, or an extension phone to the fax, and enable the INCOMING RING setting.	p. 8-4
FAX/TEL AUTO SW (Fax/Tel mode)	Fax/Tel	Automatically switches between fax and voice calls. Receives documents automatically and rings for voice calls.	Handset or extension phone connected to the fax.	p. 6-2
MANUAL MODE	Tel	Rings for every call, regardless of whether the call is a fax call or a voice call. For a fax call, you have to manually activate reception of the fax.	Handset or extension phone connected to the fax.	p. 6-4
ANS.MACHINE MODE (FAX-B120/B115 only)	Fax/Tel	Receives documents automatically and routes voice calls to the answering machine.	Answering machine connected to the fax.	p. 6-4
NET SWITCH*	Fax/Tel	Allows you to have one telephone line with two numbers: one for fax and one for telephone.	Subscription to the Telstra FaxStream™ Duet service (Australia) or the Telecom FaxAbility service (New Zealand).	

* This setting is only available for some countries.

7 USING THE BUILT-IN ANSWERING MACHINE (TAM MODE) (FAX-B140 only)

Recording the outgoing message

Before you use TAM MODE, you must record an outgoing message. Use the microphone on the operation panel to record your outgoing message. Only one outgoing message, no longer than 20 seconds, can be recorded.

Types of messages that can be recorded _____

OUTGOING MESSAGE: Answering machine message

ALT OUTGOING MSG: Answering message only, used when the recording time is set to 0 or the memory is full. Caller cannot leave a message.

VOICE MEMO: See p. 7-6.

FAXTEL MESSAGE: Message played when the Fax/Tel mode is set.

FORWARDING MSG: Message played when any new telephone messages are forwarded to a forwarding number.

Recording the outgoing message _____

To record another type of message, select the type of message you want to record in step 1, and then follow the procedure below to record it.

1 Use [◀] or [▶] to select **OUTGOING MESSAGE**.

2 Press [Record] and speak into the microphone to record your outgoing message.

TIME LEFT	19
-----------	----

The remaining recording time is displayed on the LCD.

-or-

Press [Start/Copy], use [◀] or [▶] to select **RECORD** and press [Start/Copy] again. Then speak into the microphone to record your outgoing message.

3 Press [Stop] twice when recording is finished.

You can record an alternative outgoing message, fax/telephone switching message or forwarding message by selecting the appropriate option in step 1 above and then continuing on to steps 2 and 3.





Note You cannot delete the **OUTGOING MESSAGE**. To record a new outgoing message, repeat steps 1 to 3 above. The old outgoing message will be automatically deleted when you record your new message.

8 SETTINGS AND ACTIVITY REPORTS

Selecting a menu

The USER SETTINGS, REPORT SETTINGS, TX SETTINGS, RX SETTINGS, PRINTER SETTINGS, SYSTEM SETTINGS, and TAM SETTINGS* menus allow you to customise the way your fax works. Each menu contains settings that control different functions of your fax.

- 1** Press [Function].
▼ 
Press [Start/Copy].
- 2** Use [◀] and [▶] to scroll through the menus and select the menu you want.
You can select the USER SETTINGS, REPORT SETTINGS, TX SETTINGS, RX SETTINGS, PRINTER SETTINGS, SYSTEM SETTINGS or TAM SETTINGS* menu (see pp. 8-2 to 8-6).
- 3** Press [Start/Copy] to access the settings under the menu you selected.
- 4** See the tables on the following pages (see pp. 8-2 to 8-6) for guidelines on selecting and registering settings.

 - Use [◀] and [▶] to scroll through the settings.
 - To register a setting or access a sub-setting, press [Start/Copy].
 - To return to a previous level, press [Function].
- 5** Press [Stop].
Setting ends and the fax returns to standby mode.



Note

- If at any stage you want to return to standby mode, press [Stop].
- If you pause for more than 60 seconds while accessing a menu, the fax will automatically return to standby mode.

* FAX-B140 only.

9 SOLUTIONS TO COMMON PROBLEMS

Clearing jams

Jams in the document tray

When a document jams or misfeeds in the document tray, OPEN COVER and SEE FIG. 1 are displayed on the LCD. If the fax does not feed out the document after you press [Start/Copy] for a few seconds, follow the procedures below to remove the document.



You do not need to unplug the fax when clearing document jams.

1 Open the printer cover by gently pulling it towards you.

Do not try to pull the document out without opening the printer cover since you may tear or smudge the document.

2 Push the document release button on the left-side panel of the fax.

3 Remove the document.

- Pull it gently in either direction.
- If you cannot pull the document out easily, hold down [Start/Copy] for a few seconds. The document will be fed out automatically.
- If a multipage document is loaded, remove the entire document from the document tray.

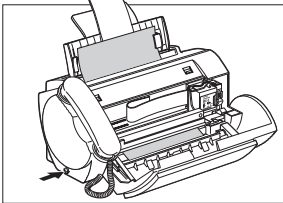

4 When you are finished, close the printer cover.

Be sure to close the printer cover until it locks into place, or the fax will not function properly.

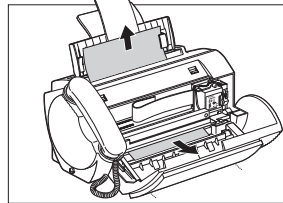

5 Press [Stop].

The fax returns to standby mode.

Specifications

Scanning sheet size:	Width: Max. 216 mm Min. 210 mm Thickness: Max. 0.13 mm Min. 0.06 mm
Effective scanning size:	Width: (A4): 208 mm
Effective printing size:	Width: 203 mm
Transmission time:	G3 ECM MMR: Approx. 6 seconds*
Scanning line density:	Horizontal: 8.00 dots/mm Vertical Standard: 3.85 lines/mm Vertical Fine: 7.70 lines/mm
Recording method:	Bubble Jet printing
Paper tray capacity:	Maximum: 50 sheets (75 g/m ²)
Paper type:	Plain cut sheet paper (A4/Letter/Legal) Paper weight: 64 g/m ² to 90 g/m ² Paper thickness: 0.08 mm to 0.13 mm
Image memory:	Up to 21 A4-size pages* (standard resolution)
Auto dial functions:	One-touch speed dialling (Registration for 9 numbers) Coded speed dialling (Registration for 50 numbers)
Ink cartridge:	Canon BX-3 Black BJ cartridge
Power source:	200-240 V/50-60 Hz
Power consumption:	Standby: Approx. 4.5 W Operation: Approx. 8 W, maximum 34 W
Operating environment:	Temperature: 10°C to 32.5°C Humidity: 20% to 85% RH
Dimensions:	410 mm (W) × 307 mm (D) × 308 mm (H) (including trays)
Weight:	Approx. 4.7 kg (with handset)

Specifications are subject to change without notice.

* Based on the Canon FAX Standard Chart No.1, Standard mode.

Index

- ☎ (extension phone) jack 1-5
- ☎ (handset) jack 1-4
- ☎ (telephone line) jack 1-4

A

AC power cord, connecting 1-6

Access type, registering 1-13

ACTIVITY REPORT

- description 8-8
- printing 8-7
- setting 8-3

Adaptor, B.T. 1-1

ALARM VOLUME setting 8-2

ALT OUTGOING MSG

(*Alternative outgoing message*)

- description 7-1

ANS.MACHINE MODE

- description 6-1, 6-4
- setting 6-4

Answering machine 1-4

- connecting 1-4
- using fax with 6-4

Attaching components 1-3

AUTO PRINT setting 8-3

AUTO REDIAL

- for FWD SETTINGS 8-6
- message 9-15
- setting 5-9, 8-3

Automatic

- dialling 5-5

Automatic redialling

- cancelling 5-9
- description 5-9
- setting options for 5-10

AUTO TEST PRINT 8-5

B

B.T. adaptor 1-1, 1-5

BJ cartridge

- BX-3 Black 1-1, 1-9
- cleaning 9-5
- guidelines 1-9
- installing 1-9, 1-10
- print head (*See* Print head)
- replacing 9-6

Broadcasting, sequential 5-13

BUSY/NO SIGNAL message 9-15

Buttons 2-2, 2-3 (*See also individual button names*)

- cursor 2-3, 2-5
- FAX-B140 2-3
- FAX-B120 2-3
- FAX-B115 2-3
- numeric 2-2, 2-4
- one-touch speed dialling 2-2
- Rewind/Forward 2-2, 7-8
- scroll 2-3, 8-1
- special function 2-2

BX-3 Black BJ cartridge 1-1, 1-9

C

Caller history 5-8

CALLING VOLUME setting 8-2

Cancelling

- automatic redialling 5-9
- delayed sending 5-11
- manual redialling 5-9
- receiving 6-6
- sending 5-5

Cartridge (*See* BJ cartridge)

Cartridge holder 2-1

CARTRIDGE JAMMED message 9-15

CHANGE CARTRIDGE message 9-16

CHECK DOCUMENT message 9-16

CHECK PAPER SIZE message 9-16

CHECK PRINTER message 9-16

Cleaning

- BJ cartridge print head 9-5
- button 2-2, 9-5, 9-6
- exterior of fax 9-3
- interior of fax 9-3, 9-4
- periodic 9-3
- print head 9-6
- scanner components 9-4

Clear button 2-2, 2-5

CLEAR PAPER JAM message 9-17

Coded dial/Directory button 2-3, 5-5, 5-6

Coded speed dialling

- description 2-12
- list (*See* Coded speed dialling list)

registering numbers and names for 2-12

sending a document using 5-5

Coded speed dialling list

- description 8-8
- printing 8-7

Components

- attaching 1-3
- main 2-1

Connecting

- AC power cord 1-6
- answering machine 1-4
- extension phone 1-6
- external devices 1-4
- handset 1-4
- telephone 1-5
- telephone line 1-4

Connector, power cord 1-6

Contrast, setting scanning 5-1

Copying

- documents 4-1
- problems 9-13
- setting scanning contrast 5-1

Cord, power 1-6

Correcting mistakes 2-5

Cursor buttons 2-3, 2-5

Customer support v

D

DATE & TIME setting 2-6, 8-2

Date, setting 2-6

DATE SETUP setting 8-5

Delayed Sending 5-10

- cancelling 5-11
- sending other documents while fax is set for 5-11

Delete button 2-3, 7-7

Deleting

- document from memory 5-15
- message 7-7

Dialling

- automatic 5-5
- directory 5-6
- long-distance 5-8
- methods 5-2
- regular 5-2
- special 5-8
- through a switchboard 1-12
- using caller history 5-8

Index

Directory dialling, sending a document using 5-6

DISPLAY LANGUAGE setting 8-5

DOC. MEMORY LIST
description 8-8
printing 8-7

DOC. TOO LONG message 9-17

Documentation 1-1

Documents
Copying 4-1
deleting from memory 5-15
different ways to receive 6-1
guides 2-1
loading 3-2
polling to receive 6-5
printing document in memory 5-14
printing list of documents in memory 5-14
problem 3-1
problems with multipage 3-2
receiving in memory when a problem occurs 6-5
receiving manually 6-4
receiving while performing other tasks 6-5
receiving with an answering machine 6-4
requirements for scanning 3-1
scanned area 3-1
sending 5-2
sending to more than one location 5-13
size 3-1
tray 1-1, 2-1
type 3-1

E

ECM RX
message 9-17
setting 8-4

ECM TX
message 9-17
setting 8-3

Extension phone 1-4
connecting 1-5

External devices, connecting 1-4

F

Fax
assembling 1-3
cleaning 9-3
main components 2-1
main unit 1-1
making connections 1-4
name, registering 2-7
number, registering 2-7
operation panel 2-2
testing 1-11
unpacking 1-1
weight 5-1

FAX-B140 1-1, 2-2, 2-3

FAX-B120 1-1, 2-2, 2-3

FAX-B115 2-2, 2-3

FAX ONLY MODE
description 6-1

FAX/TEL AUTO SW (Fax/Tel mode)
description 6-1
setting 6-2

Fax/Tel mode
description 6-1
setting 6-2

Fax/Telephone number, registering 2-7

Faxing problems 9-9

FAXTEL MESSAGE
deleting 7-7
description 7-1

Forwarded call, when a call is received 7-15

FORWARDING MSG
deleting 7-7
description 7-1

Forwarding number, setting 7-12

Forwarding telephone messages 7-12

Function button 2-2

FWD SETTINGS 8-6

FWD TEL NUMBER setting 8-6

G

General problems 9-14

Guide
document 2-1

H

Handling and maintenance, safety instructions vi

Handset 1-1, 2-1
connecting 1-4

Hook button 2-3, 5-4



I

INCOMING RING setting 8-4

Ink Saver button 2-2, 6-5

Installing, BJ cartridge 1-9

J

Jack
 (extension phone) 1-5
 (handset) 1-4
 (telephone line) 1-4

Jams
clearing 9-1
in document tray 9-1
in multi-purpose tray 9-2

K

KEYPAD VOLUME setting 8-2

L

LCD 2-2
messages 9-15 to 9-18 (*See also individual message names*)

Letters, entering 2-4

LINE MONITOR VOL setting 8-2

Line, telephone 1-4, 1-12

List (*See individual list names*)

Loading
documents 3-2
paper 1-7, 1-8

Location, safety instructions vii

Long-distance dialling 5-8

Lowercase letter mode 2-4

M

Main unit 1-1

MAN/AUTO SWITCH setting 8-4

Index

MANUAL MODE
description 6-1
receiving in 6-4
setting 6-4

Manual redialling 5-9
cancelling 5-9

Manual sending 5-4
cancelling 5-5

Memory
deleting document from 5-15
documents in 5-14
printing document in 5-14
printing list of documents in 5-14
receiving when problem occurs 6-5
sending (*See Memory sending*)

MEMORY CLEAR REPORT
description 9-19

MEMORY FULL message 9-17, 9-18

MEMORY RX setting 8-4

Memory sending 5-3
cancelling 5-4

Menu (*See individual menu names*)
PRINTER SETTINGS 8-4
REPORT SETTINGS 8-3
RX (Reception) SETTINGS 8-4
SYSTEM SETTINGS 8-5
TAM SETTINGS 8-6
TX (Transmission) SETTINGS 8-3
USER SETTINGS 8-2

MESSAGE LENGTH setting 8-6

Messages
deleting 7-7
forwarding telephone 7-12
LCD 9-15 (*See also individual message names*)
playing telephone 7-8
recording the outgoing 7-1
setting the recording time for a 7-3
types that can be recorded 7-1

Microphone (FAX-B140 only) 2-2

MID PAUSE SET setting 8-3

Mistakes, correcting 2-5

Modes, switching number and letter 2-4

MSG DATA LOST message 9-17

Multi-purpose tray 2-1
capacity 5-1
jams in 9-2
loading paper in 1-11

MULTI TX/RX (Transaction) REPORT 8-8

N

NO DATA message 9-18

NO OGM message 9-18

Nozzle check pattern
printing 9-5

Number mode 2-4

Numbers, entering 2-4

Numeric buttons 2-2, 2-4

O

OFFHOOK ALARM setting 5-4, 8-2

One-touch speed dialling
buttons 2-2
description 2-10
list (*See One-touch speed dialling list*)
registering numbers and names for 2-10
sending a document using 5-5

One-touch speed dialling list
description 8-8
printing 8-7

Operation panel 2-1, 2-2, 2-3

OUTGOING MESSAGE
description 7-1
recording 7-1

Outside line access number, registering 1-13

P

Paper
guide 1-8
guidelines 1-7
limit mark (*See Paper limit mark*)
loading 1-7
loading in multi-purpose tray 1-8
quantity 5-1
requirements 3-3
size 3-3
weight 5-1

Paper feeding problems 9-8

Paper limit mark 1-7

PAPER SIZE setting 8-4

PASSWORD setting
in TAM SETTINGS menu 8-6

Pause, entering 5-8

PBX
ACCESS NUMBER setting 8-2
ACCESS TYPE setting 8-2

PIN ENTRY setting 7-14, 8-6

Play button 2-3, 7-8

Playing telephone messages 7-8

Polling button 2-2, 6-5

Power cord 1-1, 1-6

Power failure
during 9-19
in case of 9-19

Power supply, safety instructions vii

Print head
cleaning 9-6
testing 9-5

Print quality problems 9-14

Printable area 3-3

Printer cover 2-1

PRINTER SETTINGS
menu 8-4

Printing
1-TOUCH LIST 8-7
ACTIVITY REPORT 8-7
CODED DIAL LIST 8-7
DOC. MEMORY LIST 8-7
document in memory 5-14
list of document in memory 5-14
nozzle check pattern 9-5
USER DATA LIST 8-7

Problem documents 3-2

Problems
copying 9-13
faxing 9-9
general 9-14
paper feeding 9-8
print quality 9-14
receiving 9-10
receiving in memory when 6-5
sending 9-9
telephone 9-13

PS TN setting 8-2

P UT IN CARTRIDGE message 1-8

Index

Q

Quality

- adjusting 5-1
- print problems 9-14

Quantity, paper S-1

R

R button 1-12, 2-2

- registering 1-13

R-KEY SETTING 1-13, 8-2

REC'D IN MEMORY message 9-18

Receive mode Chapter 6

Receive mode button 2-2, Chapter 6

Receiving (See also individual receive modes)

- cancelling 6-6
- in memory when problem occurs 6-5
- methods 6-1
- problems 9-10
- while performing other tasks 6-5
- with answering machine 6-4

Record button 2-3, 7-1

Recording

- outgoing message 7-1
- voice memo 7-6

REDIAL INTERVAL setting 5-10, 8-3

Redial/Pause button 2-3, 5-8, 5-9

REDIAL setting 8-3

REDIAL TIMES setting 5-10, 8-3

Redialling

- automatic 5-9
- manual 5-9

REDUCE DIMENSION setting 8-4

Registering

- access type 1-13
- coded speed dialling numbers and names 2-12
- fax/telephone number 2-7
- name 2-7
- one-touch speed dialling numbers and names 2-10
- outside line access number 1-13
- R button 1-12, 2-2
- sender information 2-6

Remote control

- features 7-9
- list of commands 7-11
- registering password for 7-9
- using 7-10

Replaging

- BJ cartridge 9-6

Report button 2-2, 8-7

REPORT SETTINGS

- menu 8-3

Resolution

- button 2-2, 4-1, 5-1
- setting scanning 5-1

Rewind/Forward buttons 2-2, 7-8

RING COUNT setting

- for INCOMING RING setting 8-4
- for TOLL SAVER setting 8-6

Ringer volume switch 1-5

ROTARY PULSE setting 1-12, 8-2

RX CALL LEVEL setting 8-2

RX REDUCTION setting 8-4

RX (Reception) REPORT

- description 8-8
- setting 8-3

RX SETTINGS

- menu 8-4

RX START SPEED setting 8-5

S

Safety instructions

- handling and maintenance vi
- location vii
- power supply vii

SCAN CONTRAST setting 8-2

Scanning

- contrast, setting 5-1
- document requirements 3-1
- resolution, setting 5-1

Scroll buttons 2-3, 8-1

Send options 5-3

Sender information, registering 2-6

Sending

- cancelling 5-5
- delayed 5-11
- documents 5-2
- manual 5-4

memory 5-3

- methods 5-2
- preparing for 5-1
- problems 9-9
- sequential broadcasting 5-13
- setting scanning contrast 5-1
- setting scanning resolution 5-1
- to more than one location (See Sequential broadcasting)
- using caller history 5-8
- using coded speed dialling 5-5
- using one-touch speed dialling 5-5
- using UCanTalk 5-7

Sequential broadcasting 5-12

Setting date and time 2-6

Setting forwarding number 7-12

Setting PIN ENTRY 7-14

Setting TAM MODE 7-2

Shipping materials, removing 1-2

Special

- dialling 5-8
- function buttons 2-2 (See also individual button names)

Speed dialling

- coded 2-12
- lists 8-8
- one-touch 2-10
- printing lists 8-7

Start/Copy button 2-3

Stop button 2-3

Switchboard, dialling through 1-12

Symbols, entering 2-5

SYSTEM SETTINGS

- menu 8-5

T

TAM button 2-3, 7-2

TAM MEMORY FULL message 9-18

TAM MODE

- description 7-2
- setting 7-2 to 7-5

TAM MONITOR setting 7-4, 8-6

TAM SETTINGS menu 8-6

TEL LINE TYPE setting 1-12, 8-2

Telephone

- connecting 1-4
- problems 9-13

Index

TELEPHONE # MARK setting 8-2

Telephone line 1-1
connecting 1-4
setting type 1-12

Telephone message
deleting 7-7
forwarding 7-12
playing 7-8
setting recording time for 7-3

Telephone problems 9-13

Testing

BJ cartridge print head 9-5
fax 1-11

Time, setting 2-6

TOLL SAVER setting 7-5, 8-6

Tray

document 1-1, 2-1
multi-purpose 2-1

TTI (Transmit Terminal Identification) 2-6

TTI position setting 8-2

TX (Transmission) REPORT

description 8-8
setting 8-3

TX SETTINGS

menu list 8-3

TX START SPEED setting 8-5

TX TERMINAL ID setting 8-2

TX/RX CANCELED message 9-18

TX/RX NO. *nnnn* message 9-18

U

UNIT NAME setting 8-2

UNIT TELEPHONE # setting 8-2

Unpacking 1-1

Uppercase letter mode 2-4

USER SETTINGS menu list 8-2

USER'S DATA LIST

description 8-8
printing 8-7

USER'S GUIDE

using this guide v

V

VOICE MEMO

description 7-6
recording 7-6

Volume

ALARM VOLUME setting 8-2

CALLING VOLUME setting 8-2

KEYPAD VOLUME setting 8-2

LINE MONITOR VOL setting 8-2

VOLUME CONTROL setting 8-2

VOLUME CONTROL setting 8-2

W

WAIT COOLING message 9-18

Warranty 1-1

Weight

document S-1
paper S-1

Jams in the multi-purpose tray

If paper jams in the multi-purpose tray, CLEAR PAPER JAM is displayed on the LCD.



You do not need to unplug the fax when clearing paper jams.

- 1** Gently pull any jammed paper out of the fax as shown. Pull it gently in either direction.
- 2** Remove the paper stack from the multi-purpose tray and reload it (see p. 1-8).

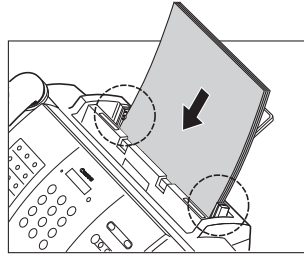
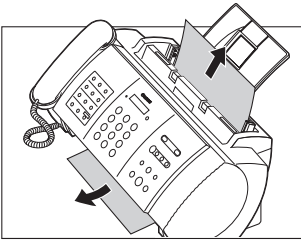

Make sure the stack does not exceed the paper limit mark (▶).

- 3** Press [Stop].

Periodic cleaning

Your fax requires little periodic maintenance. This section describes the necessary cleaning procedures for the fax. Please note the following before cleaning:

- Be sure to disconnect the power cord before cleaning the fax. Since documents in memory are erased when the power is disconnected, print any documents stored in memory before disconnecting the power cord (see p. 5-14).
- Do not use tissue paper, paper towels, or similar materials for cleaning; they can stick to the components or generate static charges.



Never use volatile liquids such as thinners, benzene, acetone, or any other chemical cleaner to clean the interior of the fax.

Cleaning the exterior of the fax

- 1 Disconnect the power cord from the fax.
- 2 Wipe the exterior of the fax with a clean, soft, lint-free cloth moistened with water or diluted dishwashing detergent solution.
- 3 When you are finished, reconnect the power cord.

Cleaning the interior of the fax

■ Cleaning inside the printer cover

To prevent ink spots and paper dust from accumulating inside the fax and affecting print quality, clean the print area of the fax periodically.

- 1 Disconnect the power cord from the fax.
- 2 Open the printer cover.



Do not touch the components or any metal parts.

- 3 Use a clean, soft, dry, lint-free cloth to remove any ink or paper debris from the interior of the fax (shaded area), especially around the four pinch rollers.

Dirt and dust particles that collect on the underside of the printer cover affect the quality of the documents you copy or send.

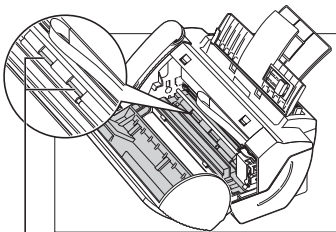

Pinch rollers

Be careful not to touch the BJ cartridge or its holder.

4 When you are finished, close the printer cover.

Be sure to close the printer cover until it locks into place.

5 Reconnect the power cord.

■ Cleaning the scanner components



Note

- If the scanner components are dirty, the documents you send or copy will also be dirty.
- Use a soft, lint-free cloth.



Caution

Do not use tissue paper, paper towels, or similar materials for cleaning.

1 Disconnect the power cord from the fax.

2 Open the printer cover.

3 While holding the white sheet open, clean the components:

Wipe with a clean, soft, lint-free cloth moistened with water, then wipe with a clean, soft, dry, lint-free cloth.

4 When you are finished, close the printer cover.

Be sure to close the printer cover until it locks into place.

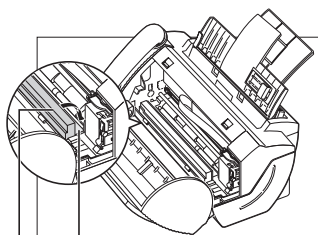

White sheet

Scanning glass

5 Reconnect the power cord.

Testing and cleaning the BJ cartridge print head

The print head in the BJ cartridge contains nozzles through which ink is propelled onto the paper. To maintain the best possible print quality, these nozzles need to be cleaned from time to time. Your fax is equipped with a print head cleaning function that does this.

■ Printing the nozzle check pattern

Before cleaning the print head, you may want to print the nozzle check pattern to test the print head of the BJ cartridge installed in the fax. This test shows if each print head nozzle is operating properly.

- 1 Press [Function].
▼
Press [Cleaning].
- 2 Use [←] or [→] to select NOZZLE CHECK.
▼
Press [Start/Copy].
The fax prints the nozzle check pattern.

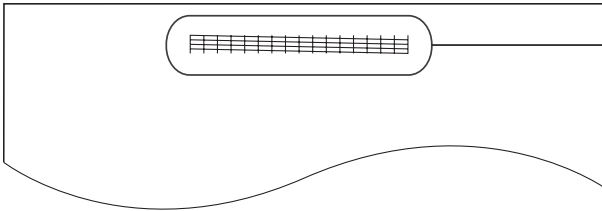

Nozzle check pattern
If the pattern is broken or missing, clean the BJ cartridge print head (see p. 9-6).



Print the nozzle check pattern again after cleaning the BJ cartridge print head to check if cleaning corrected the problem.

■ Cleaning the BJ cartridge print head

If your printouts become faint or streaked, or if their quality otherwise deteriorates, print the nozzle check pattern to see if the print head nozzles are operating properly (see p. 9-5). If the pattern is broken or missing, clean the BJ cartridge print head.



Note

- To maintain the best possible print quality, clean the BJ cartridge print head from time to time.
- Cleaning the print head consumes a small amount of ink. Cleaning too often reduces the amount of ink in the BJ cartridge.

1

Press [Function].



Press [Cleaning].

2

Use [←] or [→] to select HEAD CLEANING.



Press [Start/Copy].

The fax cleans the print head.



Note

- You can clean the print head up to five consecutive times if necessary.
- After cleaning, print the nozzle check pattern to check if cleaning corrected the problem (see p. 9-5).
- If cleaning does not improve print quality, replace the BJ cartridge (see below).

Replacing the BJ cartridge



Note

- Do not replace the BJ cartridge while the fax is printing or performing another operation.
- If you need to unplug the fax, wait until it returns to standby mode (time and receive mode displayed on the LCD). Otherwise the cartridge holder may not be in its home position, causing the BJ cartridge to remain uncapped and dry out.

1

Make sure the fax is plugged in.

2

Open the printer cover.



Caution

- Do not try to manually move or stop the cartridge holder.
- Do not touch the components shown or any metal parts.

- 3** Raise the cartridge lock lever ① on the cartridge holder and remove the BJ cartridge ②.

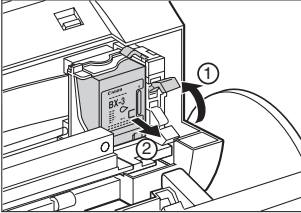

- Discard the old BJ cartridge immediately according to the local laws and regulations for disposal of consumables. You may want to place it in a plastic bag to keep any residual ink from spilling.
- Spilled ink can stain any surface; protect yourself and your work area.

- 5** With the label facing outwards, insert the BJ cartridge into the cartridge holder ①. Lower the cartridge lock lever ② until you hear a click to lock the cartridge in place.

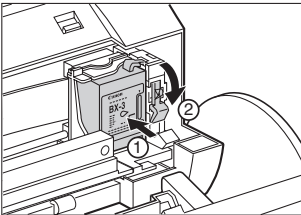

The white post (BJ cartridge guide) should be visible through the slot.
The BJ cartridge tilts slightly to the left in the loaded position.

- 4** Remove the new BJ cartridge from its package, then remove the orange protective cap ① and tape ②.

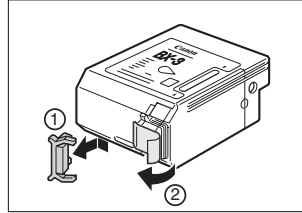

- Discard the cap and tape. Never attempt to reattach them to the BJ cartridge print head.
- Install the BJ cartridge immediately after removing the cap and tape.
- Spilled ink can stain any surface; protect yourself and your work area.

- 6** Close the printer cover. If the AUTO TEST PRINT setting is set to ON: The fax automatically prints a test page. The fax prints a test page every time you insert a BJ cartridge.

- Load the paper in the multi-purpose tray before you replace the BJ cartridge.
- You can turn off automatic test printing by changing the AUTO TEST PRINT setting. See SYSTEM SETTINGS, p. 8-5.

Troubleshooting

Paper feeding problems

❑ Paper does not load.

The multi-purpose tray may contain too many sheets.

- Make sure the paper stack in the multi-purpose tray does not exceed the paper limit mark (▶) (see p. 1-7).

Paper may not be loaded correctly.

- Make sure the paper stack is loaded properly in the multi-purpose tray, and that the paper guide is adjusted correctly (see p. 1-8).

❑ Paper is loaded skewed. (Printing is skewed.)

Paper may not be loaded correctly.

- Make sure the paper stack is loaded properly in the multi-purpose tray, and that the paper guide is adjusted correctly (see p. 1-8).
- Make sure the right edge of the paper stack is aligned with the right side of the multi-purpose tray and the paper guide is aligned with the left edge of the stack (see p. 1-8).
- Make sure the paper exit path is clear.

❑ Multiple sheets load into the fax at the same time.

Paper may not be loaded correctly.

- Make sure the paper stack is loaded properly in the multi-purpose tray, and that the paper guide is adjusted correctly (see p. 1-8).

Sheets of paper may be sticking together.

- Be sure to fan the paper stack before loading it in the multi-purpose tray. This keeps the sheets of paper from sticking together (see p. 1-8).

The multi-purpose tray may contain too many sheets.

- Make sure the paper stack in the multi-purpose tray does not exceed the paper limit mark (▶) (see p. 1-7).
- Do not exceed the maximum loading capacity of the multi-purpose tray (see p. 1-7).
- Do not force the paper stack into the multi-purpose tray.

Different types of paper may be loaded in the multi-purpose tray.

- Load only one type of paper.
- Make sure you load paper that meets the paper requirements for the fax (see Chapter 3).

❑ Repeated paper jams occur.

The paper you are using may be causing the jams.

- Be sure to fan the paper stack before loading it in the multi-purpose tray. This keeps the sheets of paper from sticking together (see p. 1-8).
- Check that the paper you are using and your printing environment (see pp. 1-7, S-1) are within the specifications of the fax (see Chapter 3).

Faxing problems

Sending problems

❑ You cannot send a document.

The BJ cartridge may not be installed properly.

- Make sure the BJ cartridge is installed properly. Do not remove a used BJ cartridge except to replace it with a new one.

The fax may have overheated.

- Unplug the fax and let it cool for several minutes. Then plug it back in and try sending again.

The fax may not be set for the type of telephone line in use (pulse/tone).

- Make sure the fax is set for the correct telephone line type (see p. 1-12).

The document may not have been loaded correctly into the document tray.

- Remove the document, stack it if necessary, and load it into the document tray correctly (see p. 3-2).
- Make sure the printer cover is closed.

The one-touch speed dialling button or coded speed dialling code you entered may not be registered for the feature you want to use.

- Check the one-touch speed dialling button or coded speed dialling code and make sure it is registered correctly (see Chapter 2).

You dialled or have been provided with an incorrect number.

- Dial the number again, or check that you have the correct number.

The receiving party's fax machine may be out of paper.

- Call the receiving party and ask them to make sure paper is loaded in their fax machine.

There may be other documents being sent from memory.

- Allow time for those documents to finish sending.

An error may have occurred during sending.

- Print an activity report and check for an error (see p. 8-7).

The telephone line may not be working properly.

- Make sure there is a dial tone when you press [Hook] or when you lift the handset. If there is no dial tone, contact your local telephone company.

The receiving fax machine may not be a G3 fax machine.

- Make sure the receiving fax machine is compatible with the fax (which is a G3 fax machine).

❑ Documents sent from the fax are spotted or dirty.

The receiving fax machine may not be working properly.

- Check the fax by making a copy (see p. 4-1). If the copy is clear, the problem may be in the receiving fax machine. If the copy is spotted or dirty, clean the scanner components (see p. 9-4).

The document may not have been loaded correctly into the document tray.

- Remove the document, stack it if necessary, and load it into the document tray correctly (see p. 3-2).

❑ Cannot send using Error Correction Mode (ECM).

The receiving party's fax machine may not support ECM.

- If the receiving party's fax machine does not support ECM, then the document is sent in normal mode without error checking.

ECM may be disabled.

- Make sure ECM is on (see ECM TX, p. 8-3).

❑ Errors occur frequently while sending.

The telephone lines may be in poor condition, or you may have a bad connection.

- Lower the transmission speed (see TX START SPEED, p. 8-5).

Receiving problems

❑ Cannot receive a document automatically.

The fax may not be set to receive automatically.

- For the fax to receive faxes automatically, the receive mode must be set to FAX ONLY MODE, FAX/TEL AUTO SW (Fax/Tel mode), or ANS.MACHINE MODE* (see Chapter 6). If you have set ANS.MACHINE MODE*, check that an answering machine is connected to the fax and that it is turned on with an outgoing message properly recorded (see p. 7-1).

The fax may have a document stored in memory.

- Print out any documents stored in memory (see p. 5-14).

An error may have occurred during reception.

- Check the LCD for an error message (see p. 9-15).
- Print an activity report and check for an error (see p. 8-7).

The multi-purpose tray may be empty.

- Make sure paper is loaded in the multi-purpose tray (see p. 1-8).

The telephone line may not be connected properly.

- Make sure all line connections are secure (see p. 1-4).

* FAX-B120/B115 only.

❑ **The fax does not switch automatically between telephone and fax reception.**

The fax may not be set to switch automatically between telephone and fax reception.

- For the fax to switch automatically, the receive mode must be set to FAX/TEL AUTO SW (Fax/Tel mode) or ANS.MACHINE MODE* (see Chapter 6). If you have set ANS.MACHINE MODE*, check that an answering machine is connected to the fax and that it is turned on with an outgoing message properly recorded (see p. 7-1).

An error may have occurred during reception.

- Check the LCD for an error message (see p. 9-15).
- Print an activity report and check for an error (see p. 8-7).

The multi-purpose tray may be empty.

- Make sure paper is loaded in the multi-purpose tray (see p. 1-8).

The sending fax machine may not send the CNG signal that tells the fax that the incoming signal is a fax.

- Some fax machines cannot send the CNG signal that tells your fax the incoming call is from a fax machine. In such cases, you will have to receive the document manually (see p. 6-4).

❑ **Cannot receive a document manually.**

You may have disconnected the call by pressing [Start/Copy] or dialling the remote receiving ID after hanging up the handset of the extension phone.

- Always press [Start/Copy] or dial the remote receiving ID before hanging up the handset, otherwise you will disconnect the call.

❑ **Print quality is poor.**

You may not be using the correct type of paper.

- Make sure you load paper that meets the paper requirements for the fax (see Chapter 3).

The BJ cartridge print head may need cleaning.

- Clean the BJ cartridge print head if necessary (see p. 9-6).

The sending fax machine may not be functioning properly.

- The sending fax machine usually determines the quality of the document. Call the sender and have them make sure the top cover and scanning glass of their fax machine are clean.

Error Correction Mode (ECM) may be disabled.

- Make sure ECM is on (see ECM RX, p. 8-4).

* FAX-B120/B115 only.

❑ **Fax does not print.**

The BJ cartridge may not be installed properly.

- Make sure the BJ cartridge is installed properly (see p. 1-9).
- Be sure to remove the orange protective tape from the BJ cartridge before you install it (see p. 1-10).

The BJ cartridge print head may need cleaning.

- Clean the BJ cartridge print head if necessary (see p. 9-6).

The BJ cartridge may need to be replaced.

- Determine if the problem is with the BJ cartridge and replace it if necessary (see p. 9-6).

❑ **Fax images print blotched or uneven.**

The telephone lines may be in poor condition, or you may have a bad connection.

- Error Correction Mode (ECM) sending/receiving should eliminate such problems. However, if the telephone lines are in poor condition, you may have to try again.

The sending fax machine may not be functioning properly.

- The sending fax machine usually determines the quality of the document. Call the sender and have them make sure the top cover and scanning glass of their fax machine are clean.

❑ **Cannot receive using Error Correction Mode (ECM).**

The sending fax machine may not support ECM.

- If the sending fax machine does not support ECM, then the document is received in normal mode without error checking.

ECM may be disabled.

- Make sure ECM is on (see ECM RX, p. 8-4).

❑ **Errors occur frequently while receiving.**

The telephone lines may be in poor condition, or you may have a bad connection.

- Lower the reception speed (see RX START SPEED, p. 8-5).

The sending fax machine may not be functioning properly.

- Call the sender and have them check that their fax machine is functioning properly.

Copying problems

❑ The fax does not make a copy.

The BJ cartridge may need to be replaced.

- Determine if the problem is with the BJ cartridge and replace if necessary (see p. 9-6).

The document may not have been loaded correctly into the document tray.

- Remove the document, stack it if necessary, and load it into the document tray correctly (see p. 3-2).
- Make sure the printer cover is closed.

The BJ cartridge may not be installed properly.

- Make sure the BJ cartridge is installed properly (see p. 1-9).

The fax may not be operating properly.

- Print the nozzle check pattern (see p. 9-5).

❑ MEMORY FULL appears on the LCD when making multiple copies.

The fax's memory is full.

- Print or delete any documents stored in memory (see pp. 5-14, 5-15) to free up space in the fax's memory, then start again.
- If you have any page fed out without being copied, simply try copying those pages again.
- Change the scanning resolution and try copying again.

The document you are copying may have too many graphics.

- If multiple pages are being copied, separate the pages into smaller stacks. If not, make the desired number of copies one at a time as needed.



Note

For additional troubleshooting, see Print quality problems, p. 9-14.

Telephone problems

❑ You cannot dial.

The telephone line may not be connected properly.

- Make sure all line connections are secure (see p. 1-4).

The power cord may not be plugged in securely.

- Check that the power cord is plugged securely into the fax and into the wall outlet (see p. 1-6). If the fax is plugged into a power strip, make sure the power strip is plugged in and turned on.

The fax may not be set for the type of telephone line in use (pulse/tone).

- Make sure the fax is set for the correct telephone line type (see p. 1-12).

❑ The handset, telephone, or extension phone disconnects while you are talking.

The power cord may not be plugged in securely.

- Check that the power cord is plugged securely into the fax and into the wall outlet (see p. 1-6). If the fax is plugged into a power strip, make sure the power strip is plugged in and turned on.

❑ There is interference on the line.

A mobile phone or cordless phone may be in use near the fax.

- Make sure that mobile phones and cordless phones are not used near the fax.

Print quality problems

The print quality is not what you expect; print is not clear, is splashed, has missing dots or white streaks.

The paper you are using may not be supported by the fax.

- Make sure you are using the recommended paper (see p. 3-3).

You may be printing on the wrong side of the paper.

- Some papers have a “right” side for printing. If the print quality is not as clear as you would like it to be, try turning the paper over and printing on the other side.

The nozzles on the BJ cartridge print head may be clogged.

- Clean the BJ cartridge print head if necessary (see p. 9-6).

The BJ cartridge may not be installed properly.

- Make sure the BJ cartridge is installed properly (see p. 1-9).

The BJ cartridge print head may be empty or damaged.

- Determine if the problem is with the BJ cartridge print head (see p. 9-5) and replace the BJ cartridge if necessary (see p. 9-6).

The printout contains blurred or smudged ink.

The paper you are using may not be supported by the fax.

- Make sure you are using the recommended paper (see p. 3-3).

You may be printing on the wrong side of the paper.

- Some papers have a “right” side for printing. If the print quality is not as clear as you would like it to be, try turning the paper over and printing on the other side.

General problems

The fax has no power.

The power cord may not be plugged in securely.

- Check that the power cord is plugged securely into the fax and into the wall outlet (see p. 1-6). If the fax is plugged into a power strip, make sure the power strip is plugged in and turned on.

The power cord may not be supplying power.

- Check the power cord by substituting with another, or by using a voltmeter to test it for continuity.

The fax will not print reports.

The BJ cartridge may need to be replaced.

- Determine if the problem is with the BJ cartridge and replace it if necessary (see p. 9-6).

Nothing appears on the LCD.

The power cord may not be plugged in securely.

- Check that the power cord is plugged securely into the fax and into the wall outlet (see p. 1-6). If the fax is plugged into a power strip, make sure the power strip is plugged in and turned on. If the LCD remains blank, unplug the fax, wait five seconds, then plug it in again.

LCD messages

The following messages are displayed on the LCD when the fax is performing a function or encounters an error. The error code appears in the activity report (see p. 8-7).

Message	Cause	Action
AUTO REDIAL	The fax is waiting to redial the receiving number because the line was busy or the receiving party did not answer when you tried to send the document.	Wait for the fax to automatically redial the number. If you want to cancel automatic redialling, wait until the fax starts dialling the number, and press [Stop] (see p. 5-9).
BUSY/NO SIGNAL	The telephone number you dialled is busy. (#018)	Try sending the document at a later time.
	The fax number dialled was incorrect.	Check the fax number and dial again.
	The other party's fax machine is not working.	Contact the other party and have them check their fax machine.
	The other party is not using a G3 machine.	Contact the other party and ask them to send or receive the document using a G3 machine.
	The touch tone/rotary pulse setting on your fax is incorrect.	Set your fax to the setting that matches your telephone line (see p. 1-12).
	The receiving fax machine did not answer within 55 seconds (after all automatic redialling attempts).	Contact the receiving party and have them check their fax machine. You can try to send the document using manual sending (see p. 5-4). For long-distance call, add pauses to the registered number (see p. 5-8).
CARTRIDGE JAMMED	The cartridge holder cannot move. This is normally due to a paper jam.	Clear the paper jam or whatever is obstructing the cartridge holder and then press [Stop] and start again. Do not attempt to move the cartridge holder manually.
	The scanner unit may not be in the fully upright position.	Press the document release button, then gently move the scanner unit to the fully upright position.

Message	Cause	Action
CHANGE CARTRIDGE	The BJ cartridge is empty.	Replace the BJ cartridge (see p. 9-6). The fax will then print automatically any documents received in memory.
CHECK DOCUMENT	The document is not set in the document tray.	Set the document you are trying to send or copy (see p. 3-2) and start again.
CHECK PAPER SIZE	The size of the paper in the multi-purpose tray and that specified in the PAPER SIZE setting are different.	Load the correct paper size or change the PAPER SIZE setting (see p. 8-4).
CHECK PRINTER	There may be an obstruction that is not allowing the cartridge holder mechanism to move.	Check for any obstruction (paper clip, small object, etc.) and also that the orange protective cap and tape are removed from the BJ cartridge. Check also for a paper jam and clear the jam if necessary (see p. 9-1). Then press [Stop] and start again.
	The BJ cartridge may be defective.	Press [Stop]. Reinstall the BJ cartridge (see p. 1-9) and start again. In either case, if the error does not clear, try unplugging the fax. Wait several minutes, then plug it back in. Also, try replacing the BJ cartridge with a new one (see p. 9-6).
	The waste ink tank (which holds the ink used for print head cleaning) may be full.	Contact your local authorised Canon dealer or the Canon help line to have the waste ink tank replaced immediately. Clear the paper jam (see p. 9-1).

Message	Cause	Action
CLEAR PAPER JAM	There is a paper jam.	Clear the paper jam (see p. 9-1) and reload paper in the multi-purpose tray. Press [Stop].
DATA ERROR	An error has occurred and all one-touch speed dialling, coded speed dialling, and user data have been lost.	Press [Start/Copy], then re-register the data (see Chapter 2).
DOC. TOO LONG	The document is longer than 750 mm.	Use a copier to make a reduced copy of the document and then send the copy.
ECM RX	The fax is receiving a document using Error Correction Mode (ECM).	ECM receptions may take longer than normal receptions. Turn off ECM if you need to receive quickly, or if you know your local lines are in good condition (see ECM RX, p. 8-4).
ECM TX	The fax is sending a document using Error Correction Mode (ECM).	ECM transmissions may take longer than normal transmissions. Turn off ECM if you need to transmit quickly, or if you know your local lines are in good condition (see ECM TX, p. 8-3).
MEMORY FULL	<p>The fax's memory is full because it has received too many documents, or a very long or detailed document.</p> <p>The fax's memory is full because you either tried to send too many pages at once, or you tried to send a very long or detailed document.</p>	<p>Print any documents stored in memory (see p. 5-14). Then start again.</p> <p>Free up space in the fax's memory by printing or deleting any documents in memory you no longer need (see pp. 5-14, 5-15). If multiple pages are loaded, separate the pages into smaller stacks. If not, try sending the document by direct sending (see p. 5-2).</p>
MSG DATA LOST	An error has occurred and all voice message data has been lost.	Re-record all answering machine messages, such as the outgoing message and alternative outgoing message (see p. 7-1).

Message	Cause	Action
NO DATA	The one-touch speed dialling button or coded speed dialling code you entered has not been registered.	Register the one-touch speed dialling button or coded speed dialling code (see pp. 2-10, 2-12).
NO OGM	The outgoing message has not been recorded.	Record an outgoing message (see p. 7-1).
REC'D IN MEMORY	The fax received the document in memory because paper or ink ran out, a paper jam occurred, or the incorrect BJ cartridge was installed.	Load paper in the multi-purpose tray (see p. 1-8), replace the BJ cartridge (see p. 9-6) or clear the paper jam (see p. 9-1).
TAM MEMORY FULL	Either 50 messages have been recorded or the total maximum recording time of 10 minutes has been reached.	Listen to your telephone messages and delete any unnecessary messages. Alternatively, erase all telephone messages stored in the fax memory (see p. 7-7).
TX/RX CANCELLED	You pressed [Stop] to cancel the transmission.	If required, try sending again.
TX/RX NO. <i>nnnn</i>	When the fax sends or receives a document, it assigns it a unique identification number (<i>nnnn</i>).	Write the number down if you will need it later.
WAIT COOLING	During printing, the BJ cartridge print head may have become too hot.	Allow the fax to cool down. The fax will resume printing when it has cooled down.

In case of a power failure

The user data settings and registered data for one-touch speed dialling and coded speed dialling are saved during a power failure using a built-in battery*. However, documents stored in the fax memory will be deleted. If a power failure occurs or the power is turned off, the fax will automatically print a memory clear report as soon as the power is turned on or the power is restored. This report includes a list of the documents that were stored in the memory at the time of power failure.

During a power failure

The following restrictions apply to the function of the fax during a power failure or while the power is turned off:

- You cannot use the fax to make telephone calls. Also, if your fax is connected to a telephone, you may not be able to make telephone calls.
- You cannot send, receive, or copy documents.
- You can receive voice calls only if the handset, a telephone, or an extension phone is connected to your fax.

Memory clear report

If you experience a power failure, the documents in the fax memory will be lost.

As soon as power is restored and the fax is turned on again, the fax will automatically print out a list of documents that were stored in the memory at the time of the power failure.

* TAM Messages are also saved if the power fails.



USER SETTINGS

<i>Name</i>	<i>Description</i>	<i>Settings</i>
DATE & TIME	Set the date and time (24-hour clock) using the numeric buttons.	-
UNIT TELEPHONE #	Enter your fax number using the numeric buttons.	-
UNIT NAME	This is the name that appears at the top of each fax page you send (see p. 2-6).	-
TX TERMINAL ID	This option sets the parameters for the identification header that appears on every page you send.	ON/OFF
TTI POSITION	Select the position of the TTI.	INSIDE IMAGE/ OUTSIDE IMAGE
TELEPHONE # MARK	Select the icon for the fax number.	TEL/FAX
SCAN CONTRAST	Set the density of the reproduction.	STANDARD/DARKER/ LIGHTER
OFFHOOK ALARM	Enable/disable the off hook alarm. The alarm alerts you that the handset is not seated properly in its cradle.	ON/OFF
VOLUME CONTROL	Set the volume of the fax sounds.	-
LINE MONITOR VOL	Set the volume of the line monitor (sound during dialling).	0 (off)/1/2/3
CALLING VOLUME	Set the volume of the ring produced when the fax detects a voice call during FAX/TEL switchover.	1/2/3
ALARM VOLUME	Set the volume of the error alarm sound.	0 (off)/1/2/3
KEYPAD VOLUME	Set the volume of the keypad.	0 (off)/1/2/3
RX CALL LEVEL	Set the ring tone.	STANDARD/HIGH
TEL LINE TYPE	Set the dialling method the fax uses to match the type of phone line you have.	TOUCH TONE/ ROTARY PULSE
R-KEY SETTING	Set the type of PBX through which your fax is connected.	PSTN/PBX
PSTN	Your fax is connected to an outside line.	-
PBX: ACCESS TYPE	Your fax is connected through a PBX.	PREFIX/HOOKING
ACCESS NUMBER	If you select PREFIX, you can enter an outside line number of up to 19 digits.	-
AUTO VOICE DIAL	Enable/disable automatic dialling for UCanTalk.	ON/OFF

REPORT SETTINGS

Name	Description	Settings
TX REPORT	Enable/disable automatic printing of the transmission report. OUTPUT NO: Turn off the activity report feature. OUTPUT YES: Set the fax to print an activity report every time you send a document. PRINT ERROR ONLY: Print only when an error occurs during sending.	OUTPUT NO/ OUTPUT YES/ PRINT ERROR ONLY
RX REPORT	Enable/disable automatic printing of the reception report. OUTPUT NO: Turn off the activity report feature. OUTPUT YES: Set the fax to print an activity report every time you receive a document. PRINT ERROR ONLY: Print only when an error occurs during receiving.	OUTPUT NO/ OUTPUT YES/ PRINT ERROR ONLY/
ACTIVITY REPORT	Enable/disable automatic printing of the activity report.	-
AUTO PRINT	When you set ON, your fax is set to print an activity report for every 20 transactions (sending and receiving).	OUTPUT NO/ OUTPUT YES
TX/RX SEPARATE	Divide the activity management report into sending and receiving transactions.	ON/OFF

TX SETTINGS

Name	Description	Settings
ECM TX	Enable/disable error correction during transmission.	ON/OFF
MID PAUSE SET	Set the length of the pause you insert into a dialling sequence.	4 seconds (1 to 15)
AUTO REDIAL	Determine whether the fax will redial a number if it fails to get a response on the first attempt.	ON/OFF
REDIAL TIMES	Set the number of retries.	2 times (1 to 10)
REDIAL INTERVAL	Set the period of time between redialling attempts.	2 minutes (2 to 99)

RX SETTINGS

<i>Name</i>	<i>Description</i>	<i>Settings</i>
ECM RX	Enable/disable error correction during reception.	ON/OFF
FAX/TEL AUTO SW	Enable/disable FAX/TEL switchover. When ON, this feature answers calls, and if no fax tone is detected, the fax rings to alert you of an incoming call.	
RING START TIME	Set the duration that the fax listens for a fax tone before starting to ring.	8 seconds (0 to 30)
F/T RING TIME	Set the length of time the fax will ring to alert you of an incoming call.	22 seconds (10 to 60)
DEFAULT ACTION	Select the action taken after the F/T RING TIME expires.	DISCONNECT/RECEIVE
INCOMING RING	When the handset or an extension phone is connected, set the fax to ring when it receives a call.	ON/OFF
RING COUNT	Set the number of incoming rings before the fax answers.	2 times (1 to 99)
MAN/AUTO SWITCH	Determine if the fax switches to document receive mode after the fax rings for a specified time when the fax is in the manual receive mode.	ON/OFF
RING TIME	Set the amount of time the fax will ring before switching to document receive mode.	15 seconds (1 to 99)
REMOTE RX	Enables/disables remote receiving.	ON/OFF
REMOTE RX ID	If you set REMOTE RX to ON, you can select the remote receiving ID.	25 (00 to 99)
MEMORY RX	Turn on/off memory receiving of a document.	ON/OFF
CALLER ID*	Determine if the fax displays the caller's name and fax number when receiving a call.	ON/OFF

* Only available in some countries.

PRINTER SETTINGS

<i>Name</i>	<i>Description</i>	<i>Settings</i>
RX REDUCTION	Enable/disable reduction for received documents.	ON/OFF
FIXED REDUCTION	Select the reduction rate.	STANDARD/ A4 →LTR/ LGL →LTR
REDUCE DIMENSION	Select reduction in height only or both width and height.	VERTICAL ONLY/ HORIZ & VERTICAL
PAPER SIZE	Select the size of the loaded fax paper.	A4/LTR/LGL

SYSTEM SETTINGS

Name	Description	Settings
AUTO TEST PRINT	Enable/disable auto test printing whenever the BJ cartridge is replaced.	ON/OFF
DATE SETUP	Set the date format.	YYYY MM/DD MM/DD/YYYY DD/MM YYYY
DISPLAY LANGUAGE	Set the language of the LCD messages.	ENGLISH/FRENCH/ SPANISH/GERMAN/ ITALIAN/DUTCH/ FINNISH/PORTUGUESE/ NORWEGIAN/SWEDISH/ DANISH/SLOVENE/ CZECH/HUNGARIAN/ RUSSIAN
TX START SPEED	Set the speed at which the fax starts transmitting. Set this to a lower speed if you have difficulties connecting over long distance or noisy lines.	14400bps/9600bps/ 7200bps/4800bps
RX START SPEED	Set the speed at which the fax starts receiving. Set this to a lower speed if you have difficulties connecting over long distance or noisy lines.	9600bps/7200bps/ 4800bps
COUNTRY SELECT*	Set the country.	OTHERS/UK/GERMANY/ FRANCE/ITALY/SPAIN/ HOLLAND/DENMARK/ NORWAY/SWEDEN/ FINLAND/AUSTRIA/ BELGIUM/ SWITZERLAND/ PORTUGAL/IRELAND/ GREECE/LUXEMBOURG/ HUNGARY/CZECH/ RUSSIA/SLOVENIA/ SOUTH AFRICA
SUMMER TIME	Enable/disable the summer time system.	ON/OFF
BEGIN DATE/TIME	Set the beginning of the summer time period.	-
END DATE/TIME	Set the end of the summer time period.	-
	MONTH: Set the beginning/end month.	JANUARY/FEBRUARY/ MARCH/APRIL/MAY/ JUNE/JULY/AUGUST/ SEPTEMBER/OCTOBER/ NOVEMBER/DECEMBER
	WEEK: Set the beginning/end week.	FIRST WEEK/SECOND WEEK/THIRD WEEK/ FOURTH WEEK/LAST WEEK
	DAY: Set the beginning/end day of the week.	MONDAY/TUESDAY/ WEDNESDAY/ THURSDAY/FRIDAY/ SATURDAY/SUNDAY
	TIME: Set the beginning/end time.	-

* Only available in some countries.

TAM SETTINGS (FAX-B140 only)

<i>Name</i>	<i>Description</i>	<i>Settings</i>
MESSAGE LENGTH	Set the maximum recording time for each recorded message.	0 seconds/30 seconds/ 60 seconds/120 seconds
PASSWORD	Set a four-digit PIN so that you can access the fax from remote locations.	1234 (0000 to 9999)
TOLL SAVER	Setting this feature to ON allows calls to be picked up after 2 rings when you have a new message.	ON/OFF
RING COUNT	If you set TOLL SAVER to OFF, this feature allows you to set the number of times the fax rings.	2 times (1 to 15)
FWD SETTINGS	Allows you to forward messages.	ON/OFF
FWD TEL NUMBER	Forwarding telephone number A maximum of 40 digits can be entered.	-
AUTO REDIAL	Redial the previously dialed number. REDIAL TIMES: Set the number of retries. REDIAL INTERVAL: Set the period of time between redialling attempts.	ON/OFF 2 times (1 to 10) 2 minutes (2 to 99)
PIN ENTRY	Pin confirmation	ON/OFF
TAM MONITOR	Allows you to screen all incoming calls.	ON/OFF

Activity reports

Your fax keeps track of most of its sending and receiving operations. These operations can be printed out in the form of activity reports that can help you check the dates and times of fax transmissions and whether or not each transaction was successful.

How to print a report

Depending on the type of report, you can have the fax print the report automatically, or you can print it directly. The TX report, RX report, MULTI TX/RX report, and Memory clear report can only be printed automatically. See REPORT SETTINGS (p. 8-3) on how and when reports are printed automatically.

- 1** Press [Function].
▼
Press [Report].
- 2** Use [◀] or [▶] to display the type of report you want to print.
▼
Press [Start/Copy].
You can select ACTIVITY REPORT, 1-TOUCH LIST, CODED DIAL LIST, or USER DATA LIST.
You can select the order in which you want destinations in the 1-TOUCH LIST or CODED DIAL LIST to be listed.

Activity report

Summarises the information for the sending and receiving activities of your fax after 20 transactions. For automatic printing, see ACTIVITY REPORT, p. 8-3.

Transactions in an activity report are listed chronologically.

One-touch speed dialling list

Lists the numbers and names registered under one-touch speed dialling buttons.

Coded speed dialling list

Lists the numbers and names registered under coded speed dialling codes.

User's data list

Lists the current settings of the fax and the registered sender information.

Doc. memory list

Lists the documents currently stored in the fax's memory (see p. 5-14).

TX (Transmission) report

You can set the fax to print an activity report every time you send a document. See TX REPORT, p. 8-3.

RX (Reception) report

Normally the fax does not print an activity report for receiving, but you can set the fax to print an activity report every time you receive a document. See RX REPORT, p. 8-3.

You can set the fax to print an activity report only when an error occurs during receiving. See RX REPORT, p. 8-3.

Multi TX/RX (Transaction) report

Lists the result of a sequential broadcasting.

If you set the fax to print activity reports (TX REPORT or RX REPORT) and then use sequential broadcasting, a MULTI TX/RX REPORT will be printed instead of a TX (Transmission) REPORT. See TX REPORT, p. 8-3.



A memory clear report is printed automatically when power is restored after a power failure. See Memory clear report, p. 9-19.

Setting TAM MODE

Setting TAM MODE allows you to receive telephone messages and fax transmissions while the fax is unattended. When you cancel TAM MODE, any new telephone messages will be played automatically.

1 Press [TAM] to set TAM MODE.

- When you set TAM MODE, the TAM LED lights up and the outgoing message is played.
- When you cancel TAM MODE, the TAM LED switches off. If you have any new telephone messages, the messages are played automatically.
- To cancel TAM MODE, press [TAM] again.

15:00

00:00



Note

- NO OGM is displayed on the LCD when no outgoing message has been recorded. You must record an outgoing message before you can set TAM MODE (see p. 7-1).
- A maximum of 55 messages, including an outgoing message, alternative message and voice memos, with a total maximum recording time of 10 minutes can be recorded. You can set a maximum recording time of 120 seconds for each telephone message (see p. 7-3).
- If you have any new telephone messages, the TAM LED blinks and the number of messages appears on the LCD.
- The date and time when the telephone message was recorded, the number of telephone messages and the number of the message being played (ICM No.) are displayed whenever a message is played.

When TAM MODE is set and a call is received, the fax will respond as described below.

1 The fax will ring 2 or 5 times, when TOLL SAVER is set to ON, depending on whether there are any telephone messages (see p. 7-5).

When TOLL SAVER is set to OFF, you can specify the number of times the fax will ring.

2 The outgoing message is played to the other party.

3 If the other party sends a fax after they leave a message, or if the call is a fax call, the fax is received automatically.



Note

When the fax is set to MANUAL MODE and MAN/AUTO SWITCH has been set to OFF, TAM MODE will be activated if the fax rings 15 times and the call is not answered (only when an outgoing message has been recorded). When the call is disconnected, the fax returns to MANUAL MODE.

Setting the recording time for a telephone message

- 1 Press [Function]. USER SETTINGS
 Press [Start/Copy].
- 2 Use [←] or [→] to select TAM SETTINGS. 30 SECONDS
 Press [Start/Copy] twice.
- 3 Use [←] or [→] to select the recording time.
 The recording time can be set to 0, 30, 60 or 120 seconds.
 Press [Start/Copy].
- 4 Press [Stop].
 Setting ends and the fax returns to standby mode.



Note

When the recording time is set to 0, the alternative outgoing message is played. If an alternative outgoing message has not been recorded, the outgoing message is played. In this case, there will be no beep after the message is played and the caller will not be able to leave a message.

Setting TAM MONITOR

TAM MONITOR allows you to screen all incoming calls.



To use this feature, LINE MONITOR VOL (see p. 8-2) must be set to a setting other than 0. If LINE MONITOR VOL is set to 0, you will not be able to hear any incoming messages as they are being recorded.

- 1** Press [Function].
▼
Press [Start/Copy].

USER SETTINGS
- 2** Use [←] or [→] to select TAM SETTINGS.
▼
Press [Start/Copy].

MESSAGE LENGTH
- 3** Use [←] or [→] to select TAM MONITOR.
▼
Press [Start/Copy].

OFF
- 4** Use [←] or [→] to select ON.
▼
Press [Start/Copy].
- 5** Press [Stop].
Setting ends and the fax returns to standby mode.

Setting TOLL SAVER

Setting TOLL SAVER allows you to check whether you have any new messages when you call from a remote location.

- 1** Press [Function].
▼
Press [Start/Copy].
- 2** Use [◀] or [▶] to select TAM SETTINGS.
▼
Press [Start/Copy].
- 3** Use [◀] or [▶] to select TOLL SAVER.
▼
Press [Start/Copy].
 - When TOLL SAVER is set to ON and there are telephone messages, the fax will ring twice before answering the call.
 - When TOLL SAVER is set to ON and there are no telephone messages, the fax will ring five times before answering the call.
- 4** Press [Start/Copy].
- 5** Press [Stop].
Setting ends and the fax returns to standby mode.

Deleting messages

- 1 Use [←] or [→] to select the type of message you want to delete.
- 2 Press [Delete].
The fax asks you to confirm that you want to delete the message.
- 3 Press [*] to delete the message.
If you do not want to delete the message, press [#].

-or-

- 1 Use [←] or [→] to select the type of message you want to delete.
▼
Press [Start/Copy].
- 2 Use [←] or [→] to select ERASE.
- 3 Press [Start/Copy].
The fax asks you to confirm that you want to delete the message.
- 4 Press [*] to delete the message.
If you do not want to delete the message, press [#].



You cannot delete the OUTGOING MESSAGE. The old outgoing message will be automatically deleted when you record your new message.

Playing telephone messages

Telephone messages will be played back in order from the oldest message recorded. If a voice memo has been recorded, it will be played back first.

1 Press [Play].

The date and time when the telephone message was recorded, the number of telephone messages and the number of the message being played (ICM No.) are displayed whenever a message is played.

SUN 17:15	02/05
-----------	-------



Note

- Press [◀◀] to listen to the message again. (Repeat)
- Press [▶▶] to play the next message. (Skip)
- Press [◀◀] twice to play the previous message.
- Press [Stop] to stop playback.
- Press [Delete] during playback to delete a message.
- Use [◀] or [▶] to change the volume.

Follow the procedures below to delete all messages.

1 Press [Delete].

YES= (*) NO= (#)

2 Press [:] to delete all messages.

If you change your mind and decide not to delete all messages, press [#].

Remote control features

Use these features when you call home to play back any messages you may have received. You can also use the remote control features to set TAM MODE.

You must register a four-digit PIN as your password before you can use these features (see below).

Registering the password for remote control _____

- 1** Press [Function].
▼ USER SETTINGS
Press [Start/Copy].
- 2** Use [←] or [→] to select TAM SETTINGS.
▼ MESSAGE LENGTH
Press [Start/Copy].
- 3** Use [←] or [→] to select PASSWORD.
▼ PASSWORD 1234
Press [Start/Copy].
- 4** Use the numeric buttons to enter a four-digit PIN as your password.
▼ Press [Start/Copy].
- 5** Press [Stop].
Registration ends and the fax returns to standby mode.

7
USING THE BUILT-IN ANSWERING MACHINE
(TAM MODE) (FAX-B140 only)

Using remote control

- 1** Call home.
- 2** The outgoing message will be played.
- 3** Press [#] while the outgoing message is playing. Enter your password when you hear the beeps indicating that you should enter your password. When your password is accepted, you will hear a confirmation tone (a short series of beeps).
- 4** The fax will now accept remote control commands (see List of remote control commands, p. 7-11).
For example, press [1][1][#] to play back any telephone messages you may have received. When playback has finished, press [9][9][#] to end the remote control.
- 5** End the remote control and hang up the handset.



Note

- A password is required to use the remote control features. However, if PIN ENTRY is set to OFF (see p. 8-6), it is not necessary to enter your password when you use the FORWARDING MSG feature (see p. 7-12).
- If you enter an invalid password, you will hear an error tone. If you enter two invalid passwords consecutively, the call will be disconnected.
- You should enter a remote command within 20 seconds of entering your password. If more than 20 seconds elapse after you enter your password and you do not enter a remote command, the call will be disconnected.
- The remote control features can be used even when the fax is set to a mode other than TAM MODE.
- In FAX ONLY MODE, the outgoing message will not be played. Press [#] when the call is connected.
- In Fax/Tel mode (FAX/TEL AUTO SW), press [#] while the Fax/Tel message is playing. If you have not set a Fax/Tel message, press [#] when the call is connected.
- In MANUAL MODE, press [#] if MAN/AUTO SWITCH has been set. If MAN/AUTO SWITCH is off, the fax will ring 15 times. Press [#] while the outgoing message is playing. Then, enter your password when you hear the beeps.

■ List of remote control commands

Command	Sub-command*	Description
11#		Play ICM
	4#	Repeat
	6#	Skip
	5#	Stop playback
	9#	Delete
19#		Delete all ICM
20#		Record voice memo
	#	End recording
21#		Play voice memo
	4#	Repeat
	5#	Stop playback
29#		Delete voice memo
31#		Record outgoing message
	#	End recording
32#		Record alternative outgoing message
	#	End recording
33#		Record forwarding message
	#	End recording
34#		Record FAX/TEL switching message
	#	End recording
41#		Play outgoing message
	4#	Repeat
	5#	Stop playback
42#		Play alternative outgoing message
	4#	Repeat
	5#	Stop playback
43#		Play forwarding message
	4#	Repeat
	5#	Stop playback
44#		Play FAX/TEL switching message
	4#	Repeat
	5#	Stop playback
50#		Cancel TAM MODE
51#		Set TAM MODE
60#		Cancel ICM forwarding mode
61#		Set ICM forwarding mode**
89#		Delete voice memo/all ICM messages
99#		End remote control

* Sub-commands are only valid while the command they are linked to is active.

** When no forwarding number has been set, ICM forwarding mode cannot be set. When TAM MODE has not been set, entering this command activates TAM MODE and ICM forwarding mode simultaneously.

7
USING THE BUILT-IN ANSWERING MACHINE
(TAM MODE) (FAX-B140 only)

Forwarding telephone messages

This feature allows you to automatically forward telephone messages, recorded when the fax is set to TAM MODE, to a registered forwarding number.

You can use remote control to access the forwarding number and listen to your telephone messages.



Note

- You must register a forwarding number and set TAM MODE before you can use this feature. Remote control cannot be used to set this feature unless a forwarding number has been registered.
- If you set FWD SETTINGS to ON when a forwarding message has not been recorded, you will hear a tone instead of a forwarding message when telephone messages are forwarded.

Setting the forwarding number

- 1** Press [Function].
▼
Press [Start/Copy].
- 2** Use [←] or [→] to select TAM SETTINGS.
▼
Press [Start/Copy].
- 3** Use [←] or [→] to select FWD SETTINGS.
▼
Press [Start/Copy].
- 4** Use [←] or [→] to select ON.
▼
Press [Start/Copy] twice.
- 5** Use the numeric buttons to enter the forwarding number.
A maximum of 40 digits can be entered.
▼
Press [Start/Copy].
- 6** Press [Stop].
Setting ends and the fax returns to standby mode.

Setting the number of redial times

- 1** Follow steps 1 to 5 on p. 7-12.
- 2** Use [←] or [→] to select AUTO REDIAL.
▼
Press [Start/Copy].
- 3** Use [←] or [→] to select ON.
▼
Press [Start/Copy] twice.
- 4** Use the numeric buttons to enter the number of redial times.
▼
Press [Start/Copy] twice.
- 5** Use the numeric buttons to enter the redial interval.
▼
Press [Start/Copy].
- 6** Press [Stop].
Setting ends and the fax returns to standby mode.

Setting PIN ENTRY

1 Follow steps 1 to 5 on p. 7-12.

FWD TEL NUMBER

2 Use [←] or [→] to select PIN ENTRY.



Press [Start/Copy].

OFF

3 Use [←] or [→] to select ON.



Press [Start/Copy].

FWD TEL NUMBER

4 Press [Stop].

Setting ends and the fax returns to standby mode.



Note

If PIN ENTRY is set to OFF, it is not necessary to enter your password when you use the FORWARDING MSG feature (see p. 7-12).

When a forwarded call is received

When FWD SETTINGS is set to ON, telephone messages recorded when the fax is set to TAM MODE will be automatically forwarded to a registered forwarding number.

1 A call is received at the forwarding number.

2 When you answer the phone you will hear your forwarding message.

3 Press [#] while the forwarding message is playing.
If you have not set a forwarding message, press [#] when you hear the tone.

4 Enter your password when you hear the beeps

- When PIN ENTRY is set to OFF (see p. 7-14), step 4 is not required.
- If you enter an invalid password, you will hear an error tone. If you enter two invalid passwords consecutively, the call will be disconnected.

5 Any new telephone messages will be played.

6 When playback ends, it will be possible to use the remote control features.
or the remote control features, see pp. 7-9 to 7-11.

7 Hang up the handset when you have finished.



Note

• **When forwarding is not possible:**

- You can set the fax to redial the forwarding number a certain number of times at specified intervals when forwarding is not possible, such as at times when the forwarding number is busy or the phone is unattended. If forwarding is still not possible after the fax redials the forwarding number the specified number of times, the forwarding setting will be temporarily cancelled. However, the fax will dial the forwarding number again when any new telephone messages are received.
- You should enter a remote command within 20 seconds of entering your password. If more than 20 seconds elapse after you enter your password and you do not enter a remote command, the call will be disconnected.



Setting the receive mode

Once you have decided which mode is suitable for your needs, set the mode by pressing [Receive Mode].

- 1 Press [Receive Mode].**
Every time you press [Receive Mode], the mode changes cyclically.
▼
Press [Start/Copy].
The fax returns to standby mode.

Receiving both documents and telephone calls automatically: Fax/Tel mode

If you set Fax/Tel mode, you can control precisely how the fax handles incoming calls by adjusting the following settings:

- Adjust the time the fax takes to check whether a call is from a fax machine or a telephone (RING START TIME setting).
- Adjust the length of time the fax rings when the call is a voice call (F/T RING TIME setting).
- Set whether the fax switches to receive mode after the ring time set in F/T RING TIME has elapsed (DEFAULT ACTION setting).

- 1 Press [Function].**
▼ USER SETTINGS
Press [Start/Copy].
- 2 Use [◀] or [▶] to select RX SETTINGS.**
▼ ECM RX
Press [Start/Copy].
- 3 Use [◀] or [▶] to select FAX/TEL AUTO SW.**
▼ RING START TIME
Press [Start/Copy].
- 4 Press [Start/Copy].**
8SEC

Setting the receive mode

-
- 5** Use the numeric buttons to enter the time the fax waits before ringing when it receives a call.
▼
Press [Start/Copy] twice.
-
- 6** Use the numeric buttons to enter the time the fax rings while waiting for someone to pick up the handset.
▼
Press [Start/Copy] twice.
-
- 7** Use [◀] or [▶] to select RECEIVE or DISCONNECT.
This setting tells the fax what to do if the handset is not picked up within the specified ring time set in step 6.
▼
-
- 8** Press [Start/Copy].
-
- 9** Press [Stop].
Setting ends and the fax returns to standby mode.

Receiving documents manually: MANUAL MODE

- 1 Check that Manual is displayed on the LCD (see p. 6-2). 15:00 Manual
- 2 Check that the handset or extension phone is connected to the fax (see p. 1-4).
- 3 When you hear the handset or extension phone rings, pick up the handset.
- 4
 - If you hear a person's voice:
Start your conversation. If the caller wants to send a document after talking to you, ask them to press the start button on their fax machine. When you hear a slow beep, press [Start/Copy] on the fax to begin receiving the document. Hang up the handset.
 - If the extension phone is located away from your fax, dial 25 (the remote receiving ID) on the extension phone and hang up.
 - The fax begins receiving the document.
 - If you hear a slow beep tone:
Someone is trying to send you a document.
 - Press [Start/Copy] and hang up the handset.
 - If the extension phone is located away from your fax, dial 25 (the remote receiving ID) on the extension phone and hang up.
 - The fax begins receiving the document.



Note

Be sure to hang up the handset after you press [Start/Copy] otherwise the call will be disconnected.

Receiving documents with an answering machine: ANS.MACHINE MODE (FAX-B120/B115 only)

Connecting an answering machine to your fax allows you to receive documents and telephone messages while you are out.

■ Using your fax with an answering machine

Follow these guidelines when using your fax with an answering machine.

- Set the answering machine to answer on the first or second ring.
- When recording an outgoing message on the answering machine, the entire message must be no longer than 15 seconds.

Other features

Saving ink while receiving documents

You can enable/disable ink-saving feature by pressing the [Ink Saver] button when the [Function] button is pressed.

- 1 Press [Function].
▼
Press [Ink Saver].
- 2 Use [←] or [→] to select ON or OFF.
▼
Press [Start/Copy].
The fax returns to standby mode.

Receiving documents in memory while performing another task or when a problem occurs

If your fax is performing another task or encounters a problem when receiving a document, it automatically stores the unprinted pages in memory, and the LCD displays REC'D IN MEMORY as well as one or more messages. For an explanation of the message(s) and details on the action to take, see p. 9-18.



Note

- You can set the fax not to store documents in memory if a problem occurs during reception (see MEMORY RX, p. 8-4).
- Once the pages are printed, they are deleted from memory.

Polling to receive documents

The polling feature allows you to request a document to be faxed to you from another fax machine. The sending party only needs to make sure the document is on a fax machine and ready to be sent. Thus, when your fax polls the other fax machine, the document is sent automatically. The fax can poll any fax machine that supports polling.



Note

- Before attempting to poll a fax machine, make sure that the other fax machine supports polling.
- If the other party is using a Canon fax machine which has the Polling ID function, ask them to set the Polling ID of their fax machine to 255 (11111111 binary number).
- For details on the Polling ID, see the other party's fax machine manual. In all other cases the Polling ID is not a concern.
- Your fax cannot be polled by another fax machine.

1 Press [Function].

▼
Press [Polling].

▼
Press [Start/Copy].

2 Dial the fax number of the fax machine you wish to poll.

TEL= 34567890

Use one of the dialling methods described on page 5-2.

3 Press [Start/Copy].

Your fax begins receiving the document.

cancelling receiving

1 Press [Stop].

Sending methods

- Direct sending (see below)
- Memory sending (see p. 5-3)
- Manual sending (see p. 5-4)

Dialling methods

There are several methods of dialling the receiving party's number, depending on how your fax is set up.

- Regular dialling
- One-touch speed dialling (see p. 5-5)
- Coded speed dialling (see p. 5-5)
- Directory dialling (see p. 5-6)
- UCanTalk (see p. 5-7)

Sending documents

Direct sending

1 Load the document face up into the document tray.

See Loading documents, p. 3-2.

You can set the scanning resolution and contrast (see p. 5-1).

2 Dial the receiving party's fax number.

Use one of the dialling methods described in this chapter.

TEL=	34567890
------	----------

3 Press [Start/Copy] twice.

The fax begins sending.



Note

- If an error occurs during sending, the fax beeps intermittently for a few seconds and an error message appears on the LCD. If this happens, correct the error and then press [Stop], then try sending the document again. See LCD messages, p. 9-15.
- The fax automatically redials if the receiving party does not answer or if the line is busy. (You can specify the number of times it redials; see AUTO REDIAL, p. 8-3.)

Memory sending

The fax normally uses direct sending to send your document, but you can send it with memory sending (see below). In this case, the fax quickly scans the document into memory. Then it sends the document from memory. This means you do not have to wait for the fax to finish sending before you can retrieve your original document.

You can send up to 15 A4-size pages at a time with memory sending (based on the Canon FAX Standard Chart No.1, standard resolution).



Note

If MEMORY FULL appears on the LCD when you load the document into the document tray or during the scanning process, re-start sending the document using direct sending (see p. 5-2).

1 Load the document face up into the document tray.

See Loading documents, p. 3-2.

You can set the scanning resolution and contrast (see p. 5-1).

2 Press [Function].

▼
Press [Send Options].

3 Use [←] or [→] to select MEMORY TX.

▼
Press [Start/Copy].

4 Dial the receiving party's fax number.

Use one of the dialling methods described in this chapter (see p. 5-2).

TEL=	34567890
------	----------

5 Press [Start/Copy] twice.

The fax scans the document into memory and begins sending.

Manual sending

If you would like to first speak with the person you are sending the document to, use manual sending. You need to connect the handset or extension phone to the fax for manual sending.

1 Load the document face up into the document tray.

See Loading documents, p. 3-2.

You can set the scanning resolution and contrast (see p. 5-1).

2 Pick up the handset or press [Hook] and dial the receiving party's fax number.

TEL=	34567890
------	----------

Use one of the dialling methods described in this chapter (see p. 5-2).

3 If a person answers, converse normally, then ask them to press the start button on their fax. Press [Start/Copy] and hang up.

If you hear a high pitch tone, press [Start/Copy] and hang up.



Note

- The fax will beep if the handset is not hung up properly. Make sure the handset is seated properly in its cradle. If you do not want the fax to beep, disable the OFFHOOK ALARM setting (see p. 8-2).
- If an error occurs during sending, the fax beeps intermittently for a few seconds and an error message appears on the LCD. If this happens, correct the error and then press [Stop], then try sending the document again. See LCD messages, p. 9-15.

Cancelling sending

1 Press [Stop].



Note

- When you cancel sending, you may need to press [Start/Copy] for a few seconds, then the fax will feed out the document.
- The fax prints an ERROR TX REPORT (see p. 8-7).

Automatic dialling

Sending a document using one-touch speed dialling or coded speed dialling numbers

To use this feature you must first register numbers for one-touch speed dialling (see pp. 2-10, 2-11) or coded speed dialling (see p. 2-12).

1 Load the document face up into the document tray.

See Loading documents, p. 3-2.

You can set the scanning resolution and the contrast (see p. 5-1).

2 Press the one-touch speed dialling button under which the number you wish to fax is registered.
-or-

TEL=	905 795 1111
------	--------------

Press [Coded Dial/Directory] and enter the appropriate two-digit coded speed dialling code.

TEL=	1 49 39 25 25
------	---------------

The registered name and number appear.

- If you make a mistake, press [Stop]. Then press the correct one-touch speed dialling button or press [Coded Dial/Directory] and re-enter the code.
- If an error message appears on the LCD, correct the error and press [Stop]. If necessary, see Faxing problems, p. 9-9.

3 Press [Start/Copy].

The fax begins sending.

Sending a document using directory dialling _____

This feature is convenient when you know the other party's name but cannot recall the one-touch speed dialling button or the code for coded speed dialling where the number is registered.

This procedure can also be used to look up the other party's name and retrieve the number for dialling.

1 Load the document face up into the document tray.

See Loading documents, p. 3-2.

You can set the scanning resolution and the contrast (see p. 5-1).

2 Press [Coded Dial/Directory] twice.

DIRECTORY DIAL

3 Press a numeric button to enter the first letter of the name of the party you are searching for.

*01 Canon CANADA

4 Press [◀] or [▶] to display the other names and numbers registered for the button letter group.

- The names for one-touch speed dialling numbers are prefixed with two digits and the names for coded speed dialling numbers are prefixed with an asterisk (*) and two digits.
- When you reach the last name and number registered for the letter group, you will return to the first name and number in the group.
- If the LCD does not change after you press [◀] or [▶], this means only one name and number is registered for the button you just pressed.
- Press [Redial/Pause] to switch between the name and number on the LCD.

5 With the telephone number you want to dial displayed, press [Start/Copy] to start the document transmission.

Sending a document using UCanTalk (FAX-B140 only)

To use this feature you must first register the voice tags for UCanTalk (see p. 2-13).

1 Load the document face up into the document tray.

See Loading documents, p. 3-2.

You can set the scanning resolution and the contrast (see p. 5-1).

2 Press [UCanTalk]. Then speak the voice tag into the microphone.

CANON

The registered name will be displayed on the LCD.

3 With the party's name you wish to dial displayed, press [Start/Copy] to start the document transmission.

- If the AUTO VOICE DIAL setting is set to ON, the fax automatically starts the document transmission (see p. 8-2).
- If the displayed party's name is not what you are searching for, press [Stop] to cancel the procedure, and re-start from step 2.
- If an error occurs every time you speak into the microphone, re-register the voice tag and try again (see pp. 2-10 to 2-13).

Special dialling

Sending a document using caller history

If the CALLER ID setting is set to ON, the caller's name and phone/fax number appear on the LCD when you receive a call (see p. 8-4). The fax keeps up to 20 latest caller IDs in memory.



The caller history feature is only available in some countries. The feature uses the ETS300778 protocol. Contact your local telephone company for detailed information.

1

Press [Function].

Press [Caller History].

The date and time, names, and numbers from which you have received calls recently will be displayed on the LCD.

- Press [Redial/Pause] or [Coded Dial/Directory] to switch between the date and time, name, and phone number on the LCD.

20/12	13:30
CANON	
TEL=	34567890

2

Use [←] or [→] to select the receiving party.

Press [Start/Copy].

The fax begins calling the number.

3

If a person answers, pick up the handset and converse normally.

If you want to send a document, load the document face up into the document tray (see Loading documents, p. 3-2) and ask them to press the start button on their fax.

See Manual sending, p. 5-4.

4

When you hear a high pitch tone, press [Start/Copy] and hang up.

The fax begins sending the document.

Long-distance dialling

When you register a long-distance number, you may have to insert a pause within or after the number. For long-distance dialling, the location and length of the pause may differ depending on the telephone system. To enter a pause, press [Redial/Pause]. A pause within a number is 2 seconds long.

The length of this pause can be adjusted. See MID PAUSE SET, p. 8-3. A pause at the end of a number is fixed at 10 seconds.

Redialling when the line is busy

There are two methods of redialling: manual redialling and automatic redialling. This section explains these two methods.

Manual redialling

Press [Redial/Pause] to dial the last number you dialled with the numeric buttons. (This starts redialling regardless of whether automatic redialling is enabled.)

■ Cancelling manual redialling

To cancel manual redialling, press [Stop].

Automatic redialling

■ What is automatic redialling?

When you are sending a document and the receiving party's line is busy, the fax waits the specified time and then dials the same number again. You can set the fax to redial several times if previous attempts fail because of a busy signal.

Automatic redialling can be turned off and on. The number of redialling attempts and the time interval between attempts can also be adjusted (see AUTO REDIAL, p. 8-3).

If all redialling attempts are unsuccessful, the fax will cancel the transmission and print an ERROR TX REPORT to remind you that the transmission was not completed (see p. 8-7).

When automatic redialling is in use, the LCD displays AUTO REDIAL while it is waiting to redial.

■ Cancelling automatic redialling

Automatic redialling cannot be cancelled with the [Stop] button while the fax is waiting to redial.

1 Wait until the fax begins redialling.

2 Press [Stop].



Note

If you want to cancel a memory-sending transmission while the fax is waiting to redial, you will have to delete the document from memory (see p. 5-15).

■ Setting the options for automatic redialling

You can set the following options for automatic redialling:

- Whether or not the fax redials automatically.
- The number of times the fax attempts to redial.
- The time interval between redialling attempts.

- 1** Press [Function].
▼
Press [Start/Copy].
- 2** Use [◀] or [▶] to select TX SETTINGS.
▼
Press [Start/Copy].
- 3** Use [◀] or [▶] to select AUTO REDIAL.
▼
Press [Start/Copy].
 - To disable automatic redialling, use [◀] or [▶] to select OFF, then press [Start/Copy]. Press [Stop] to return to standby mode.
 - To enable automatic redialling, use [◀] or [▶] to select ON and continue with the steps below.
- 4** Press [Start/Copy] twice.
- 5** Use the numeric buttons to enter the number of times you want the fax to redial.

You can select from 1 to 10 times (see p. 8-3).

▼
Press [Start/Copy] twice.
- 6** Use the numeric buttons to enter the time interval between redialling attempts.

You can select from 2 to 99 minutes (see p. 8-3).

▼
Press [Start/Copy].
- 7** Press [Stop].
The fax returns to standby mode.

Delayed sending

Your fax can send a document automatically at a preset time. This allows you to take advantage of lower late-night long-distance rates offered by some telephone companies.

1 Load the document face up into the document tray.

See Loading documents, p. 3-2.

You can set the scanning resolution and contrast (see p. 5-1).

2 Press [Function].

▼
Press [Send Options].

3 Use [◀] or [▶] to select DELAYED TX.

▼
Press [Start/Copy].

SET TIME	15:00
----------	-------

4 Enter the desired sending time (24-hour clock) using the numeric buttons.

- Set the time using the 24-hour clock system.
Precede single digits with a zero.
Example: 3:00 p.m. = 15:00
- Press [Clear] if you need to re-enter the time.
- You can also use [◀] or [▶] to move the cursor.

5 Press [Start/Copy].

6 Enter the receiving party's fax number.

- You can enter the receiving party's fax number using the numeric buttons, one-touch speed dialling, coded speed dialling, or directory dialling (see pp. 5-5, 5-6).
- If you use the numeric buttons, press [Start/Copy] after entering the number to register it before going on to the next number.

7 Press [Start/Copy] twice.

The fax scans the document into memory.

8 When the set time comes, the fax dials and sends the document.

Sending other documents while the fax is set for delayed sending

You can send, receive, and copy other documents even when the fax is set for sending at a preset time.

The fax can only register one preset sending operation at a time.

To send or copy other documents after setting the fax for delayed sending, simply send or copy using any other sending procedure in this guide.



Delayed sequential broadcasting is applicable for sending one document to more than one location at a later time when multiple fax numbers are dialled (see p. 5-13).

Cancelling delayed sending

- 1** Press [Function].
- 2** Use [←] or [→] to select MEMORY REFERENCE.
▼
Press [Start/Copy].
- 3** Use [←] or [→] to select DELETE DOCUMENT.\ TX/RX NO. 0001
▼
Press [Start/Copy].
- 4** Use [←] or [→] to select the transaction number (TX/RX NO.) of the document you want to delete. YES= (*) NO= (#)
 - If the LCD does not change after you press [←] or [→], this means only one transaction is stored in memory.
 - If you are unsure of the transaction number (TX/RX NO.), print the Doc. memory list (see p 5-14).▼
Press [Start/Copy].
- 5** Press [*] to delete the file.
If you change your mind and want to continue sending, press [#].
- 6** Press [Stop].
The fax returns to standby mode.

Sequential broadcasting

Sending a document to more than one location _____

Sequential broadcasting sends one document to more than one location.

You can send to a total of 60 locations as follows:

- One-touch speed dialling = 9 locations
- Coded speed dialling = 50 locations
- Regular dialling (Numeric buttons dialling) = 1 location

You can enter the one-touch speed dialling and coded speed dialling locations in any order. You simply press the one-touch speed dialling button, or press [Coded Dial/Directory] followed by the two-digit code.

You can also include one location using regular dialling. Remember that when using regular dialling, you must press [Start/Copy] after entering the number.



Note

You must press each button within 10 seconds of the preceding one. The fax begins the operation approximately 10 seconds after you press the last button.

1 Load the document face up into the document tray.

See Loading documents, p. 3-2.

You can set the scanning resolution and contrast (see p. 5-1).

2 Dial the receiving party's fax numbers as you need.

You can also press [Redial/Pause] to redial the last number dialled with the numeric buttons.

TEL=	34567890
------	----------

3 Press [Start/Copy].

- The fax reads the document into memory and begins sending.
- To cancel a transmission, press [Stop] during dialling or transmission. All transmissions in the sequence are cancelled.

Documents stored in memory

Printing a list of documents in memory _____

Your fax can print a list of documents stored in memory, along with the transaction number (TX/RX NO.) of each document. Once you know the transaction number of a document in memory, you can print it or delete it.

- 1 Press [Function].
- 2 Use [◀] or [▶] to select MEMORY REFERENCE. DOC. MEMORY LIST
▼
Press [Start/Copy].
- 3 Press [Start/Copy].

Printing a document in memory _____

- 1 Press [Function].
- 2 Use [◀] or [▶] to select MEMORY REFERENCE. DOC. MEMORY LIST
▼
Press [Start/Copy].
- 3 Use [◀] or [▶] to select PRINT DOCUMENT. TX/RX NO. 0001
▼
Press [Start/Copy].
- 4 Use [◀] or [▶] to select the transaction number (TX/RX NO.) of the document you want to print.
If you are unsure of the transaction number (TX/RX NO.), print the Doc. memory list (see above).
- 5 Press [Start/Copy]. 1ST PG ONLY?
1 sec.
YES= (✳) NO= (#)

6 Press [*****] to print the first page only, or press [#] to print all pages of the document.

The fax prints the document.

7 To continue printing other documents in memory, repeat the procedure from step 4.

To finish, press [Stop].

Deleting a document from memory

1 Press [Function].

2 Use [◀] or [▶] to select MEMORY REFERENCE.

DOC. MEMORY LIST

Press [Start/Copy].

3 Use [◀] or [▶] to select DELETE DOCUMENT.

TX/RX NO. 0001

Press [Start/Copy].

4 Use [◀] or [▶] to select the transaction number (TX/RX NO.) of the document you want to delete.

- If the LCD does not change after you press [◀] or [▶], this means only one transaction is stored in memory.
- If you are unsure of the transaction number (TX/RX NO.), print the Doc. memory list (see p. 5-14).

5 Press [Start/Copy].

The fax asks you to confirm that you want to delete the document.

YES=(*) NO=(#)

6 Press [*****] to delete the document.

If you change your mind and want to keep the document in memory, press [#].

7 To continue deleting other documents in memory, repeat the procedure from step 4.

To finish, press [Stop].





Loading documents

- 1 Adjust the document guide to the width of the document, and gently insert the top of the document face up into the document tray until you hear a beep.

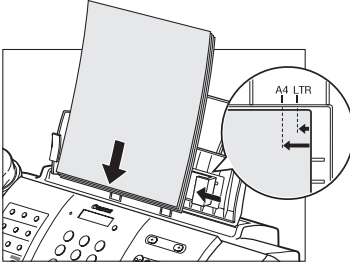

Note

- For a multipage document, the pages are fed one by one from the top of the stack.
- Wait until all pages of your document have been scanned before starting a new job.
- Make sure you follow the procedure above to load documents into the document tray. If the document is not loaded into the document tray correctly, it may not be fed into the fax properly; resulting in a jam, or in pages not being sent.
- If you want to send a document with more than 15 pages, divide the document into 2 sections and send each section in a separate transmission.

Problems with multipage documents

If you have trouble feeding multipage documents from the document tray into the fax, remove the stack and tap it on a flat surface to even the edges. Then slant the stack so that its front edge is bevelled, and insert the stack into the document tray.

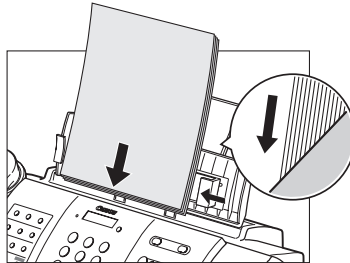

Note

To avoid feeding problems, make sure the document meets the document requirements (see p. 3-1).

Paper requirements

Your fax supports A4-, letter-, and legal-size paper in portrait orientation. You can use regular copier paper, cotton bond paper, or typical letterhead. Your fax does not require special ink jet paper. Always use paper without curls, folds, staples, or damaged edges. Look at the label on the package to see if the paper has a preferred side for printing.



Be sure to test paper before purchasing large quantities.

Printable area

The shaded area below shows the printable area of A4-size paper. Be sure to print within this area.

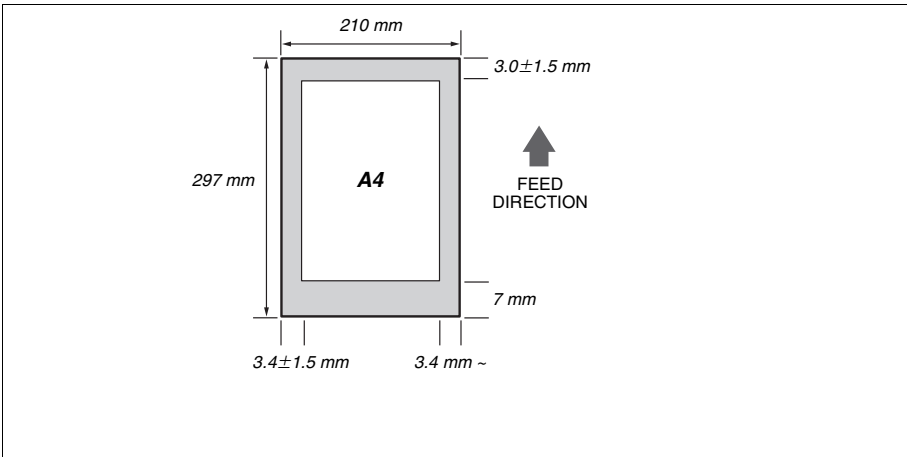

Loading paper

For details on loading paper in the multi-purpose tray, see p. 1-8.



Fax controls – the operation panel

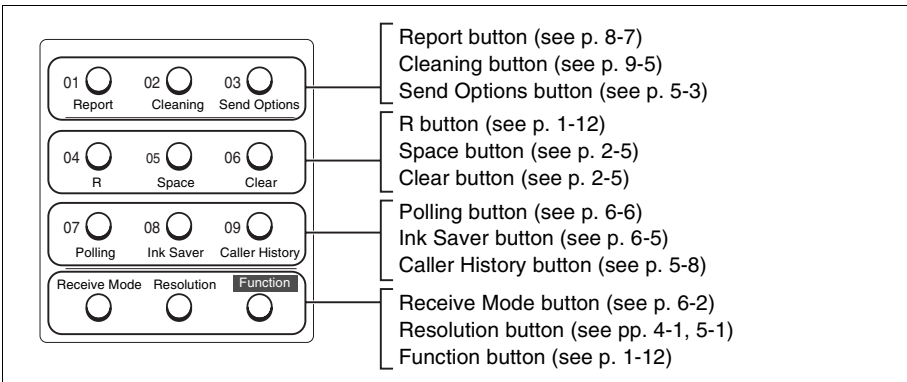
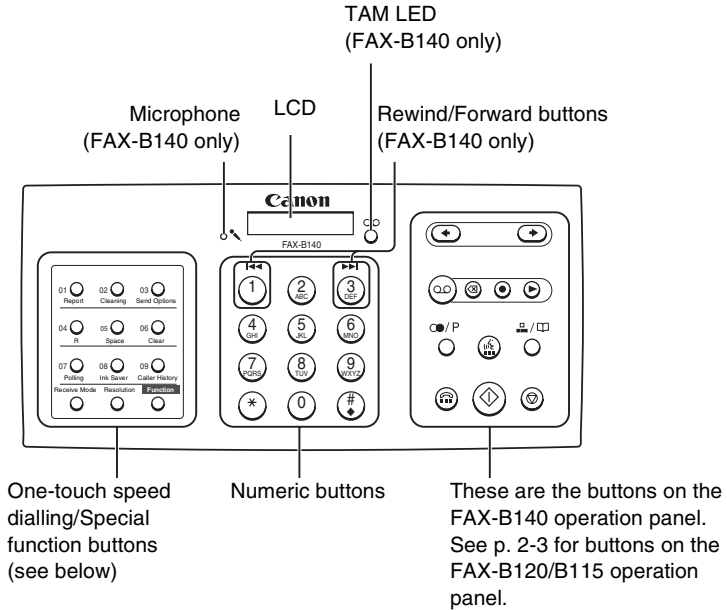

The buttons on the left of the operation panel have the following two functions:

- One-touch speed dialling buttons (see p. 2-10)
- Special function buttons
 - When the [Function] button is pressed, the special function buttons (function marked under each button) can be used to perform various operations.

■ FAX-B120/B115

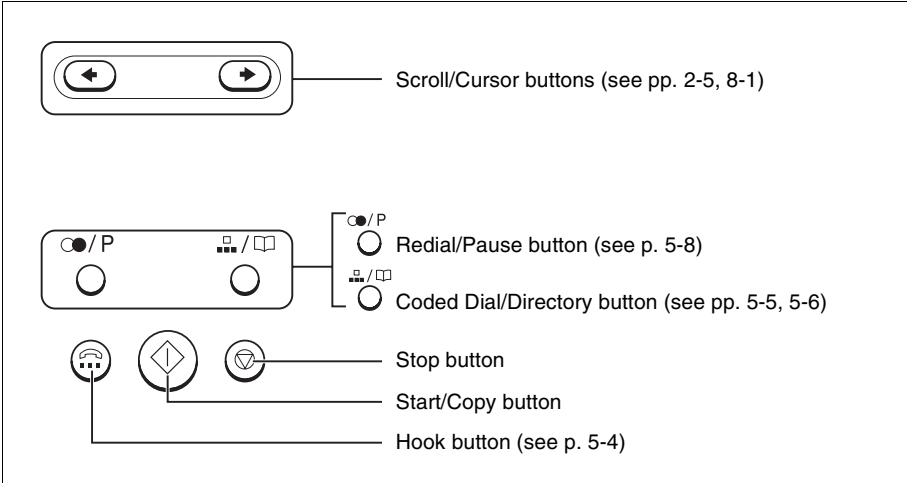

■ FAX-B140

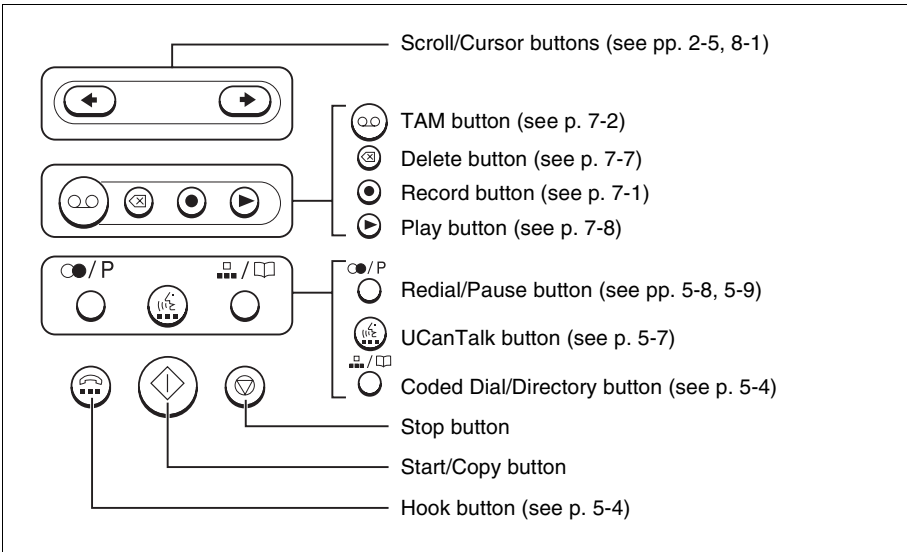

Guidelines for entering numbers, letters, and symbols

When you come to a step that requires you to enter a name or number, see the table below to determine which numeric button to press for the letter you want.

Button	Uppercase Letter Mode (:A)	Lowercase Letter Mode (:a)	Numer Mode (:1)
①			1
<small>ABC</small> ②	ABCĂĂĂĂĂĂÆÇ	abcăăăăăăæç	2
<small>DEF</small> ③	DEFĎĎĎĎĎ	defďďďďď	3
<small>GHI</small> ④	GHIİİİİ	ghiıııı	4
<small>JKL</small> ⑤	JKL	jkl	5
<small>MNO</small> ⑥	MNOÑŃŎŎŎŎŎ	mnoññŏŏŏŏŏ	6
<small>PQRS</small> ⑦	PQRSP	pqrsp	7
<small>TUV</small> ⑧	TUVÛÛÛÛÛ	tuvûûûûû	8
<small>WXYZ</small> ⑨	WXYZÝ	wxyzý	9
⑩			0
#	- . * # ! " , ; : ^ ` _ = / ' ? \$ @ % & + () [] { } < >		
*	Uppercase Letter mode (:A) → Lowercase Letter mode (:a) → Numer mode (:1)		



After 60 seconds of no operation panel input, the fax returns to standby mode and any unregistered changes are lost.

■ Entering letters and numbers

1

Press [*****] to switch mode.

— :A

2

Press the numeric button that contains the letter you want.

C :A

- Press repeatedly until the letter you want appears.
- If you are unsure which button to press, see the table above.

3 Continue entering other letters using the numeric buttons.

- If the next letter you want to enter is under a different numeric button, simply press that button until the letter you want appears.
-or-
If the next letter you want to enter is under the same numeric button you pressed in step 2, press [▶] to move the cursor to the right. Then press that same numeric button repeatedly until the letter you want appears.
- To enter a space, press [Space].

■ Entering symbols

1 Press [#] repeatedly until the symbol you want appears.

#	: 1
---	-----

2 If you want to enter another symbol, press [▶] to move the cursor to the right, then press [#] repeatedly until the symbol you want appears.

Correcting mistakes

You can clear an entire entry by pressing [Clear]. Alternatively, follow the procedure below to correct individual letters:

1 Use [◀] or [▶] to move the cursor under the incorrect letter.

CANEN	: A
-------	-----

2 Use the numeric buttons to enter the correct letter over the incorrect letter.

CANON	: A
-------	-----

3 When you have finished making corrections, press [Start/Copy] to register your new entry.

Registering sender information

Personalising your fax

■ Identifying your documents

When sending a document, you can have your fax number and your name (known as your ID), and the current date and time printed out by the receiving fax machine. This information is called your TTI (Transmit Terminal Identification) and appears at the top of the faxed document in small type.

By identifying the documents you send, the receiving party will be able to recognise your fax messages at a glance. The illustration below shows a sample document with the identifying information.

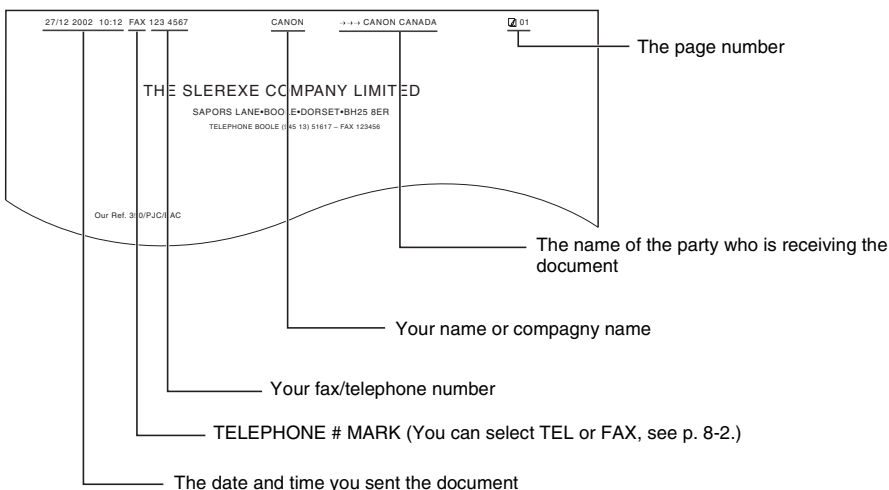

The top line includes the name of the receiving party if you send the document using one-touch speed dialling or coded speed dialling and you registered the party's name.

Setting the date and time

The date and time appear on the LCD as well as on the documents you send.

1 Press [Function].

20/12 2002 13:30

Press [Start/Copy] three times.

2 Use the numeric buttons to enter the date and time using the day-month-year format (DD/MM YYYY).

- Set the time using the 24-hour clock system. Precede single digits with a zero. Example: 3:00 p.m. = 15:00
- To change the date format, see SYSTEM SETTINGS, p. 8-5.

3 Press [Start/Copy].

4 Press [Stop].

Registration ends and the fax returns to standby mode.

Registering your fax/telephone number and name

This information appears at the top of each document you send.

1 Press [Function].

DATE & TIME

Press [Start/Copy] twice.

2 Use [←] or [→] to select UNIT TELEPHONE #.

Press [Start/Copy].

3 Enter your fax number (up to 20 digits) using the numeric buttons.

TEL= 123 4567

You can enter a plus sign (+) or space to make your number easier to read. To enter a plus sign (+), press [#].

Press [Start/Copy] twice.

4 Enter your name (up to 16 letters) using the numeric buttons (see p. 2-4).

CANON :A

Press [Start/Copy].

5 Press [Stop].

Registration ends and the fax returns to standby mode.

Setting the summer time

Some countries adopt the summer time system that shifts the clock time ahead or back according to the change in seasons. You can select if the time information in your FAX changes to match your country's summer time system and set the day and time when the summer time begins and ends.

- 1** Press [Function].
▼
Press [Start/Copy].
- 2** Use [◀] or [▶] tot select SYSTEM SETTINGS.
▼
Press [Start/Copy].
- 3** Use [◀] or [▶] tot select SUMMER TIME.
▼
Press [Start/Copy].
- 4** Use [◀] or [▶] tot select ON or OFF.
▼
Press [Start/Copy].
- 5**
 - If you selected OFF in step 4, press [Stop] to return to standby mode.
 - If you selected ON in step 4, use [◀] or [▶] to select BEGIN DATE/TIME.▼
Press [Start/Copy] twice.
- 6** Use [◀] or [▶] tot select the month in which the summer time starts.
▼
Press [Start/Copy].
- 7** Use [◀] or [▶] to select WEEK.
▼
Press [Start/Copy].

-
- 8** Use [←] or [→] to select the week in which the summer time starts.
- ▼
Press [Start/Copy].
-
- 9** Use [←] or [→] to select DAY.
- ▼
Press [Start/Copy].
-
- 10** Use [←] or [→] to select the day of the week which the summer time starts.
- ▼
Press [Start/Copy].
-
- 11** Use [←] or [→] to select TIME.
- ▼
Press [Start/Copy].
-
- 12** Use the numeric buttons to enter the time at which the summer time compensation is made.
- ▼
Press [Start/Copy].
-
- 13** Press [Function].
-
- 14** Use [←] or [→] to select END DATE/TIME.
- ▼
Press [Start/Copy] twice.
-
- 15** Set the month, week, the day of the week, and time when the summer time ends, as in step 6 to 12.
-
- 16** Press [Stop].
Setting ends and the fax returns to standby mode.

Registering one-touch speed dialling numbers and names

The quickest way to dial a fax number is to use one-touch speed dialling. This allows you to dial a number by pressing a single button. Before you can use one-touch speed dialling, you must register the receiving number (up to 50 digits) with your fax.

You can also register the name of the party (up to 16 letters) and a voice tag*; the name appears on the printout of the one-touch speed dialling list.

- 1** Press [Function].
- 2** Use [←] or [→] to select TEL REGISTRATION.
▼
Press [Start/Copy].
- 3** Press [Start/Copy].
- 4** Use [←] or [→] to select the number of the one-touch speed dialling button you want to use for the number.
If a number is already registered under this one-touch speed dialling button, the number is displayed on the LCD.**
- 5** Enter the party's number (up to 50 digits) using the numeric buttons.
▼
Press [Start/Copy] to register the number.
- 6** Enter the party's name (up to 16 letters) using the numeric buttons (see p. 2-4).
▼
Press [Start/Copy] to register the name.
- 7** Register the party's voice tag for UCanTalk*.
See Registering UCanTalk voice tags, p. 2-13.
The fax asks you if you want to register the voice tag.
▼
Press [*] or [#] to select YES or NO.

* FAX-B140 only.

** To delete the name and number registered under the one-touch speed dialling button, press [Clear] and [Start/Copy] after you perform steps 1 to 4 above.

8

- If you selected **NO** in step 7, proceed to step 9.
- If you selected **YES** in step 7:

After a tone, speak the party's name into the microphone.

The fax asks you to speak the party's name again.



After a tone, speak into the microphone again.

9

To assign additional one-touch speed dialling numbers, start from step 4.

To finish, press [Stop].

Registering coded speed dialling numbers and names

Use coded speed dialling to dial a fax number at the press of three buttons. A fax/telephone number up to 50 digits can be registered under each two-digit speed dialling code (01-50) and you can register up to 50 locations. You can also register the name of the party (up to 16 letters) and a voice tag*; the name appears on the printout of the coded speed dialling list.

- 1** Press [Function].
- 2** Use [◀] or [▶] to select TEL REGISTRATION.
▼
Press [Start/Copy].
- 3** Use [◀] or [▶] to select CODED SPEED DIAL.
▼
Press [Start/Copy].
- 4** Use [◀] or [▶] to select the two-digit code under which you want to register the number.
If a number is already registered under this coded speed dialling code, the number is displayed on the LCD.**
- 5** Enter the party's number and name the same way you registered them for one-touch speed dialling.

See steps 5 to 8, Registering one-touch speed dialling numbers and names, p. 2-10.
- 6** Register the party's voice tag the same way you registered it for one-touch speed dialling (see pp. 2-10, 2-13).
- 7** To assign additional coded speed dialling numbers, start from step 4.
To finish, press [Stop].

* FAX-B140 only.

** To delete the name and number registered under the coded speed dialling code, press [Clear] and [Start/Copy] after you perform steps 1 to 4 above.

Registering UCanTalk voice tags (Fax-B140 only)

UCanTalk allows you to dial a number by speaking the receiving party's name to the fax. Before you can use the UCanTalk feature, you must register voice tags.

You can register a name or phrase (no longer than 3 seconds) you want to use to retrieve the party, such as the first name, family name, nickname, company name, official position, and so forth. You can register up to 15 voice tags.



You can check whether a voice tag has been registered for a specific one-touch or coded speed dialling entry by printing the speed dialling lists. Entries with a voice tag are preceded by an icon.

Registering voice tags with one-touch/coded speed dialling numbers and names _____

Follow the procedures on Registering one-touch/coded speed dialling numbers and names, pp. 2-10 to 2-12.

Adding voice tags to the one-touch/coded speed dialling numbers _____

- 1 Press [Function].
- 2 Use [←] or [→] to select TEL REGISTRATION.
▼
Press [Start/Copy].
- 3 Use [←] or [→] to select 1-TOUCH SPD DIAL or CODED SPEED DIAL.
▼
Press [Start/Copy].
- 4 Use [←] or [→] to select the receiving party you want to add a voice tag to.
▼
Press [Start/Copy] twice.
- 5 When the fax asks you if you want to add a voice tag, press [*] to select YES.

If a voice tag is already registered under this speed dialling number, the fax asks you if you want to modify the voice tag (see Modifying voice tags, p. 2-14).

6 After the tone, speak the party's name into the microphone.

The fax asks you to speak the name again.

▼
After the tone, speak into the microphone again.

- Keep background noise to a minimum to ensure reliable operation.
- Registering the same or similar voice tags for different parties may cause an error when you try to retrieve the party.

7 To assign additional voice tags, start from step 4.
To finish, press [Stop].

Modifying voice tags

1 Perform steps 1 to 4 on p. 2-13.

2 If a voice tag is already registered under the speed dialling number, the fax asks you if you want to modify the voice tag.

▼
Press [*] to select YES.

3 Use [←] or [→] to select REDO VOICETAG.

▼
Press [Start/Copy].

The fax asks you to confirm that you want to redo the voice tag registration.

4 Press [*] to select YES and proceed to step 6 on p. 2-13.

Press [#] to cancel the procedure.

Deleting voice tags

1 Perform steps 1 and 2 on Modifying voice tags above.

2 Use [←] or [→] to select DELETE VOICETAG.

▼
Press [Start/Copy].

The fax asks you to confirm that you want to delete the voice tag.

3 Press [*] to select YES to delete the voice tag.

Press [#] to cancel the procedure.

Removing the shipping materials _____

- 1** Remove the shipping tapes ① from the top of the fax and the protective piece ②.
- 2** Open the printer cover by gently pulling it towards you.

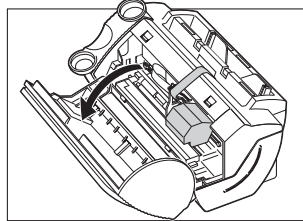
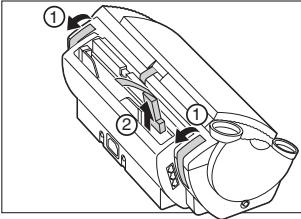

- 3** Remove the shipping tape ① and the protective piece ②.
Close the printer cover until it locks into place.

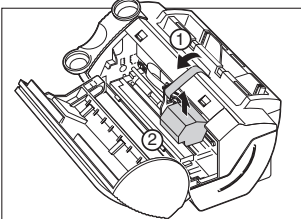

Note

The actual shipping materials may differ in shape, quantity, and position from the ones shown above.

Assembling the fax

Attaching components



For user convenience, the one-touch sheet provided with your fax (in some countries) should be fitted over the one-touch speed dialling buttons on the left of the operation panel.

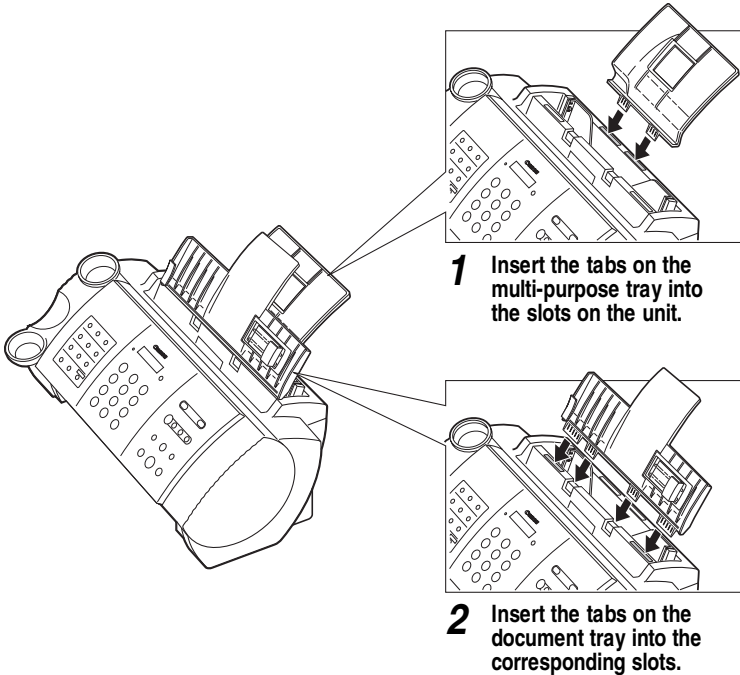

Making connections

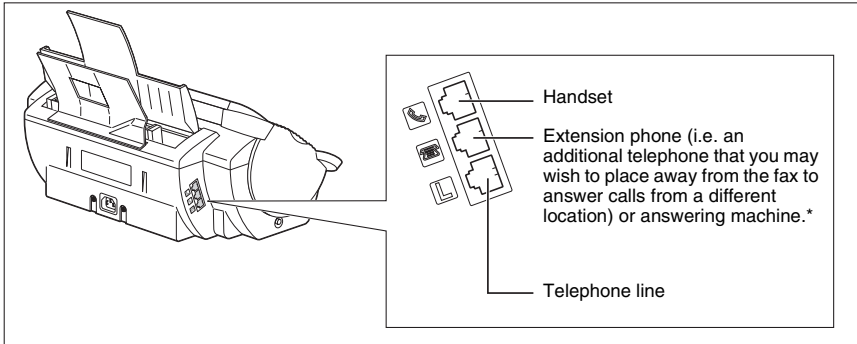

Connecting the telephone line, handset, and external devices

There are three jacks on the left side of the fax for connection of the following:



If you only have one telephone line and plan to use the fax for receiving both fax and voice calls, you will need to connect the handset or an answering machine* to the fax.

Be sure to connect any external devices before using the fax.

- 1** Connect the supplied telephone line cord to the  jack, then the other end to the telephone line jack on your wall.
- 2** Place the handset in its cradle, and connect it to the  jack.

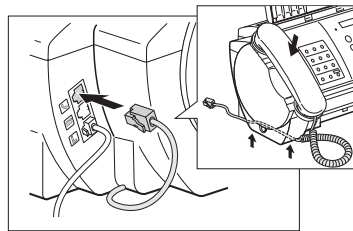
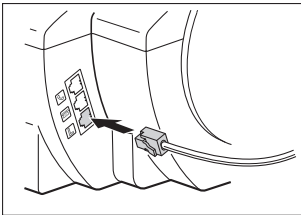

* An answering machine can be connected to the FAX-B120/B115 only.

Ringer volume switch

Adjust the volume of the ringer. Use a pen or other pointed object to adjust the switch to HIGH, LOW or OFF.

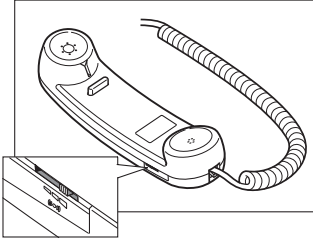

3 Connect an extension phone or answering machine* to the jack.

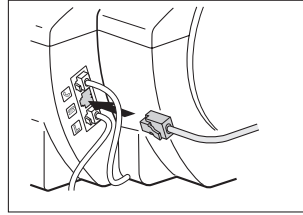

Note

- Due to the range of specifications, Canon cannot guarantee that all answering machines* will be compatible with your fax.
- If you have connected an external device to your fax, be sure to select the correct receive mode (see Chapter 6).
- To connect an extension phone as well as an answering machine, connect the extension phone to the answering machine, and then connect the answering machine* to your fax.
- If the extension phone does not have its own power supply, any redial data in the extension phone memory may be lost after an extended fax transmission.

Users in the U.K. only:

When you connect a telephone, be sure to connect the B.T. Adaptor. Contact your local authorised Canon dealer or the Canon help line.

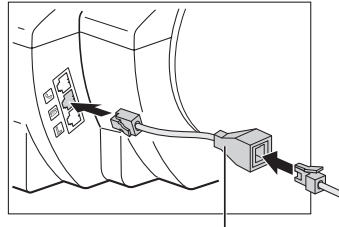

B.T. adaptor

* An answering machine can be connected to the FAX-B120/B115 only.

Connecting the AC power cord _____

Plug the fax into a 200-240 volt AC 50/60 Hz outlet.

- 1** Plug the power cord connector into the rear of the fax.
- 2** Plug the other end of the power cord into a properly grounded AC power outlet.



There is no power switch on the fax. The power is on as long as the fax is plugged in.

Note

Setting the language and country _____

When you plug in the fax for the first time, you need to select the correct language for the LCD display and reports, and the country* of use. See pp. 2-2, 2-3 for the buttons on the operation panel.

- 1** Press [Start/Copy].
- 2** Use [←] or [→] to select the preferred language for the LCD display and reports.

EUROPE

▼
Press [Start/Copy].
Wait a second for COUNTRY SELECT* to appear.

▼
Press [Start/Copy].
- 3** Use [←] or [→] to select the country where you are using the fax*.

▼
Press [Start/Copy].
Registration ends and the fax enters standby mode.

* This setting is only available for some countries.

Loading paper

Paper guidelines

- Be sure to load paper of the correct size, weight, and quantity recommended for your fax (see pp. 3-1, S-1).
- Store all paper wrapped and on a flat surface until ready to use. Keep opened packs in their original packaging, in a cool, dry location.
- Store paper at 18°-24°C, 40%-60% relative humidity.
- To avoid paper jams and poor print quality, do not print on damp, curled, wrinkled, or torn paper.
- Use cut-sheet paper only, not paper that comes on a roll.
- Use only paper that has a thickness of between 0.08 and 0.13 mm. Thick paper may damage the BJ cartridge print head.
- Do not load paper beyond the paper limit mark (▶) or beyond the tab on the paper guide. Doing so may cause problems. Also, make sure there are no gaps on either side of the paper stack.

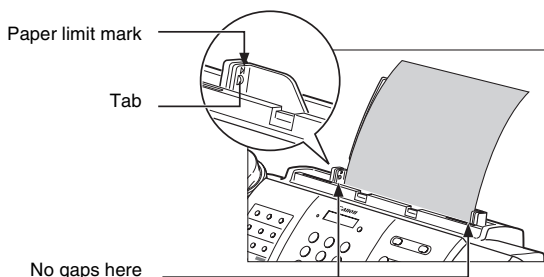

- Let the paper run out before refilling the multi-purpose tray. Avoid mixing new stock with paper already loaded.
- Do not leave paper stacked in the multi-purpose tray for long periods of time since it may bend or curl and cause problems.
- Certain environmental conditions, such as extreme temperatures or humidity, can cause some paper to misfeed in the multi-purpose tray. If you have trouble, feed one sheet at a time.
- Depending on the density of the printed pages, the ink may need time to dry. Within two or three seconds, the ink becomes smudge-resistant. After drying for several minutes, the ink becomes water-resistant.
- If your printed page contains a large amount of graphics, the ink on the page may be damp due to the print density. Leave the page for 30 to 60 seconds to allow the ink to dry. Then remove the page carefully without touching any surfaces.
- If paper curls after printing, remove it immediately; otherwise paper jams may occur.
- The platen (a roller inside the fax) may become inked if you print data beyond the width of the page. If this happens, clean inside the fax (see p. 9-3).

Loading paper in the multi-purpose tray _____

1 Move the paper guide to the left.

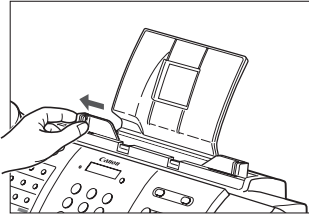

2 Fan the stack of paper that you want to feed into the fax. Then tap the edge of the stack on a flat surface to even the stack.

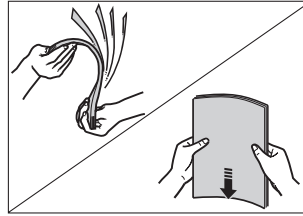

3 Insert the stack into the multi-purpose tray ①, and align the right edge of the stack with the right side of the multi-purpose tray. Then slide the paper guide snugly against the left edge of the stack ②.

If necessary, remove the document tray when loading paper.

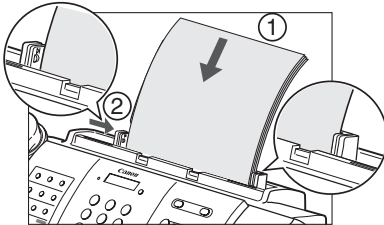

Installing the BJ cartridge

The first time you set up your fax, you have to install the BJ cartridge before you can begin receiving and copying documents.

For information on replacing the BJ cartridge, see p. 9-6.

Guidelines

- Use only a Canon BX-3 Black BJ cartridge in your fax.
- Store BJ cartridges at room temperature.
- When the BJ cartridge print head is left exposed, it easily dries out and becomes unusable. To avoid this, keep the followings:
 - Keep BJ cartridges in the packaging until you are ready to use them.
 - Never remove the BJ cartridge unless you are going to replace it.
 - Keep the cartridge holder in the home position (on the right side of the fax) when you are not using the fax.
- Replace BJ cartridges after one year of use.



Note

If you need to unplug the fax, wait until it returns to standby mode (time and receive mode displayed on the LCD). Otherwise the cartridge holder may not be in its home position; causing the BJ cartridge to remain uncapped and dry out.



Caution

- **Store BJ cartridges out of the reach of children. If a child inadvertently ingests ink, consult a physician immediately.**
- **Do not touch the precision components on the BJ cartridge.**

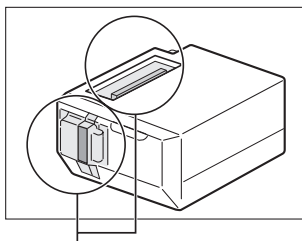

Do not touch these metallic areas.

The ink in the BJ cartridge is difficult to clean up if spilled. Follow the precautions below when handling the BJ cartridge.

- Carefully remove packaging from BJ cartridges.
- Do not attempt to disassemble or refill BJ cartridges.
- Do not shake or drop BJ cartridges.

Installing the BJ cartridge in your fax _____

When there is no BJ cartridge installed in your fax, PUT IN CARTRIDGE is displayed on the LCD.

- 1** Make sure the fax is plugged in.
- 2** Load the paper in the multi-purpose tray.
- 3** Open the printer cover by gently pulling it towards you (see p. 1-2).
- 4** Raise the cartridge lock lever on the cartridge holder.

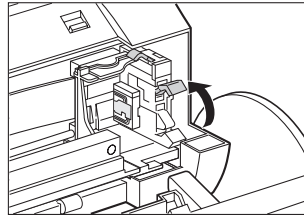
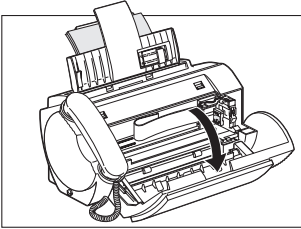

- 5** Remove the BJ cartridge from its package, then remove the orange protective cap ① and tape ②.
- 6** With the label facing outwards, insert the BJ cartridge into the cartridge holder. Lower the cartridge lock lever until you hear a click to lock the cartridge in place.

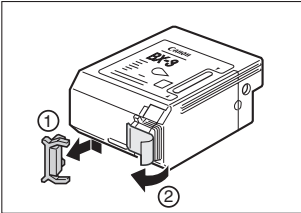

Discard the cap and tape. Never attempt to reattach them to the BJ cartridge print head.

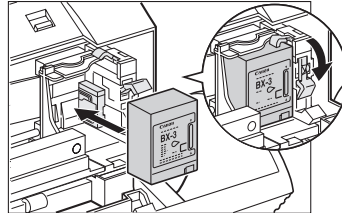

The white post (BJ cartridge guide) should be visible through the slot. The BJ cartridge tilts slightly to the left in the loaded position.

- 7** Close the printer cover.
If the **AUTO TEST PRINT** setting is set to **ON**:
The fax automatically prints a test page.
The fax prints a test page every time you insert a BJ cartridge.

You can turn off automatic test printing by changing the **AUTO TEST PRINT** setting. See **SYSTEM SETTINGS**, p. 8-5.



- Do not try to manually move or stop the cartridge holder.
- Do not touch the components shown below or any metal parts.

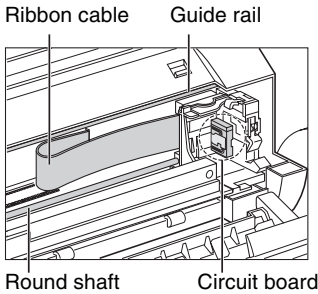

Testing the fax

After you have assembled the fax, installed the BJ cartridge, and loaded the paper, you can make sure the fax is printing properly by making several copies of a document (see p. 4-1).

If you have problems printing, see Chapter 9.

Setting the TEL LINE TYPE

See pp. 2-2, 2-3 for the buttons on the operation panel.

- 1** Press [Function].
▼
Press [Start/Copy] twice. DATE & TIME
- 2** Use [←] or [→] to select TEL LINE TYPE.
▼
Press [Start/Copy]. ROTARY PULSE
- 3** Use [←] or [→] to select TOUCH TONE.
▼
Press [Start/Copy]. R-KEY SETTING
- 4** Press [Stop].
Setting ends and the fax returns to standby mode.

Dialling through a switchboard (PBX)

A PBX (private branch exchange) is an on-site telephone switchboard.

- If your fax is connected through a switchboard, dial an outside line access number first. Then dial the rest of the number.
- If you want to dial with automatic dialling, you may have to insert a pause between the outside line number and the telephone number when you register the number for one-touch or coded speed dialling.
- When the fax is connected to a PBX or other telephone switching system, you can register the access type and outside access line number under the [R] button (see p. 1-13). Once you have registered them, you simply need to press [R] before dialling a fax or telephone number.

Registering the access type and the outside line access number

See pp. 2-2, 2-3 for the buttons on the operation panel.

- 1** Press [Function].

- 2** Press [Start/Copy] twice. DATE & TIME

- 3** Use [←] or [→] to select R-KEY SETTING.
▼
Press [Start/Copy]. PSTN

- 4** Use [←] or [→] to select PBX.
▼
Press [Start/Copy]. HOOKING

- 5** Use [←] or [→] to select the access line type for the switching system.
You can select PREFIX or HOOKING.
▼
Press [Start/Copy].

- 6** If you chose PREFIX in step 5:
Enter the outside line access number (up to 19 digits) using the numeric buttons and then press [Redial/Pause].
▼
Press [Start/Copy]. TEL= 123456P

- 7** Press [Stop].
Registration ends and the fax returns to standby mode.



Table of Contents

INTRODUCTION

Using this guide	v
Customer support	v
Important safety instructions	vi

1. SETTING UP

Unpacking	1-1
Removing the shipping materials	1-2
Assembling the fax	1-3
Attaching components	1-3
Making connections	1-4
Connecting the telephone line, handset, and external devices	1-4
Connecting the AC power cord.....	1-6
Setting the language and country	1-6
Loading paper	1-7
Paper guidelines.....	1-7
Loading paper in the multi-purpose tray	1-8
Installing the BJ cartridge	1-9
Guidelines.....	1-9
Installing the BJ cartridge in your fax.....	1-10
Testing the fax	1-11
Setting the TEL LINE TYPE	1-12
Dialling through a switchboard (PBX)	1-12
Registering the access type and the outside line access number.....	1-13

2. PREPARING TO USE YOUR FAX

Main components of your fax	2-1
Fax controls — the operation panel	2-2
Guidelines for entering numbers, letters, and symbols ..	2-4
Correcting mistakes.....	2-5
Registering sender information	2-6
Personalising your fax	2-6
Setting the date and time.....	2-6
Registering your fax/telephone number and name.....	2-7
Setting the summer time.....	2-8
Registering one-touch speed dialling numbers and names	2-10
Registering coded speed dialling numbers and names	2-12
Registering UCanTalk voice tags (Fax-B140 only)	2-13
Registering voice tags with one-touch/coded speed dialling numbers and names	2-13
Adding voice tags to the one-touch/coded speed dialling numbers	2-13
Modifying voice tags	2-14
Deleting voice tags	2-14

Table of Contents

3. DOCUMENTS AND PAPER

Preparing documents	3-1
Types of documents you can scan	3-1
Problem documents.....	3-1
Loading documents	3-2
Problems with multipage documents	3-2
Paper requirements	3-3
Printable area	3-3
Loading paper.....	3-3

4. MAKING COPIES

Copying documents	4-1
--------------------------------	------------

5. SENDING DOCUMENTS

Preparing to send a document	5-1
Adjusting the quality of your documents	5-1
Sending methods.....	5-2
Dialling methods	5-2
Sending documents	5-2
Direct sending.....	5-2
Memory sending	5-3
Manual sending	5-4
Cancelling sending	5-5
Automatic dialling	5-5
Sending a document using one-touch speed dialling or coded speed dialling numbers	5-5
Sending a document using directory dialling	5-6
Sending a document using UCanTalk (FAX-B140 only)	5-7
Special dialling	5-8
Sending a document using caller history	5-8
Long-distance dialling.....	5-8
Redialling when the line is busy	5-9
Manual redialling	5-9
Automatic redialling	5-9
Delayed sending	5-11
Sending other documents while the fax is set for delayed sending.....	5-12
Cancelling delayed sending.....	5-12
Sequential broadcasting	5-13
Sending a document to more than one location	5-13
Documents stored in memory	5-14
Printing a list of documents in memory.....	5-14
Printing a document in memory.....	5-14
Deleting a document from memory	5-15

Table of Contents

6. RECEIVING DOCUMENTS

Different ways to receive a document.....	6-1
Setting the receive mode	6-2
Receiving both documents and telephone calls	
automatically: Fax/Tel mode	6-2
Receiving documents manually: MANUAL MODE	6-4
Receiving documents with an answering machine:	
ANS.MACHINE MODE (FAX-B120/B115 only)	6-4
Other features	6-5
Saving ink while receiving documents	6-5
Receiving documents in memory while performing	
another task or when a problem occurs	6-5
Polling to receive documents.....	6-5
Cancelling receiving.....	6-6

7. USING THE BUILT-IN ANSWERING MACHINE (TAM MODE) (FAX-B140 only)

Recording the outgoing message	7-1
Types of messages that can be recorded	7-1
Recording the outgoing message	7-1
Setting TAM MODE	7-2
Setting the recording time for a telephone message	7-3
Setting TAM MONITOR.....	7-4
Setting TOLL SAVER	7-5
Recording voice memos.....	7-6
Deleting messages	7-7
Playing telephone messages	7-8
Remote control features.....	7-9
Registering the password for remote control.....	7-9
Using remote control	7-10
Forwarding telephone messages.....	7-12
Setting the forwarding number	7-12
Setting the number of redial times.....	7-13
Setting PIN ENTRY	7-14
When a forwarded call is received.....	7-15

Table of Contents

8. SETTINGS AND ACTIVITY REPORTS

Selecting a menu	8-1
Activity reports	8-7
How to print a report	8-7
Activity report	8-8
One-touch speed dialling list	8-8
Coded speed dialling list	8-8
User's data list	8-8
Doc. memory list	8-8
TX (Transmission) report	8-8
RX (Reception) report	8-8
Multi TX/RX (Transaction) report	8-8

9. SOLUTIONS TO COMMON PROBLEMS

Clearing jams	9-1
Jams in the document tray	9-1
Jams in the multi-purpose tray	9-2
Periodic cleaning	9-3
Cleaning the exterior of the fax	9-3
Cleaning the interior of the fax	9-3
Testing and cleaning the BJ cartridge print head	9-5
Replacing the BJ cartridge	9-6
Troubleshooting	9-8
Paper feeding problems	9-8
Faxing problems	9-9
Copying problems	9-13
Telephone problems	9-13
Print quality problems	9-14
General problems	9-14
LCD messages	9-15
In case of a power failure	9-19
During a power failure	9-19
Memory clear report	9-19

Specifications	S-1
-----------------------------	------------

Index	I-1
--------------------	------------



This equipment conforms with the essential requirements of EC Directive 1999/5/EC. We declare that this product conforms with the EMC requirements of EC Directive 1999/5/EC at nominal mains input 230V, 50Hz although the rated input of the product is 200V-240V, 50/60Hz.

If you move to another EU country and are experiencing trouble, please call the Canon Help Desk.

(For Europe Only)

Model Name

- H12263 (FAX-B140)
- H12261 (FAX-B120/B115)

Copyright

Copyright © 2002 by Canon Inc. All rights reserved. No part of this publication may be reproduced, transmitted, transcribed, stored in a retrieval system, or translated into any language or computer language in any form or by any means, electronic, mechanical, magnetic, optical, chemical, manual, or otherwise, without the prior written permission of Canon Inc.

Trademarks

Canon, UCanTalk, and BJ are registered trademarks. UHQ is a trademark of Canon Inc.

All other product and brand names are registered trademarks, trademarks or service marks of their respective owners.



As an ENERGY STAR® Partner, Canon Inc. has determined that these products meet the ENERGY STAR® guidelines for energy efficiency.

Using this guide

This guide provides detailed information on how to set up, operate, maintain, and troubleshoot your fax. Please read the list below to become familiar with the symbols, terms, and abbreviations used in this guide.



Cautions tell you how to avoid actions that could injure you or damage your fax. In order to use your fax safely, always observe these cautions.



Notes provide advice on using your fax more effectively, describe operating restrictions, and tell you how to avoid minor difficulties. Reading these is recommended to make the most of your fax and its functions.

(see p. xx)	Indicates a page number that you can refer to for more information on the topic of the previous sentence or paragraph.
default	A setting that remains in effect unless you change it.
document	The original sheet(s) of paper you send or receive with your fax.
menu	A list of settings from which you select an item to set up or change. A menu has a title which appears on the LCD.
◀ and ▶ buttons	Used to select an item in a menu. Press ▶ to select the next item, and press ◀ to select the previous item.
transaction number	When you send or receive a document, your fax automatically assigns the document a unique transaction number. A transaction number is a four-digit number that will help you keep track of documents you send and receive.
TX/RX NO.	TX/RX NO. is the abbreviation used for “transaction number.”
TX	Denotes Transmission.
RX	Denotes Reception.
	LCD display. The contents of the LCD display may vary depending on the current settings.

In addition, this guide uses brackets to identify the buttons you press when performing different functions: [Stop].



This guide contains information for three Canon models. Please note that the illustrations of the fax in this guide may differ from your model. Instructions for specific models are labelled with the fax names.

Customer support

Your fax is designed with the latest technology to provide trouble-free operation. If you encounter a problem with the fax's operation, try to solve it by using the information in Chapter 9. If you cannot solve the problem or if you think your fax needs servicing, contact your local authorised Canon dealer or the Canon help line.

Important safety instructions

Read these safety instructions thoroughly before using your fax.



Except as specifically described in this guide, do not attempt to service the fax yourself. Never attempt to disassemble the fax: opening and removing its interior covers will expose you to dangerous voltages and other risks. For all service, contact your local authorised Canon dealer or the Canon help line.

■ Handling and maintenance

- Follow all warnings and instructions marked on the fax.
- Do not subject the fax to strong physical shock or vibration.
- Always unplug the fax before moving or cleaning it.
- To avoid paper jams, never unplug the power cord, open the printer cover, or remove paper from the multi-purpose tray while printing.
- When transporting the fax, leave the BJ cartridge installed in the cartridge holder and tape the cartridge holder to the right side of the fax. This will prevent ink spilling inside the fax.
- Always lift the fax by its base as shown below. Never lift it by any of its attachments or covers.

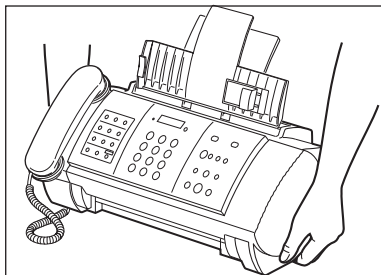

- Do not push objects of any kind into the slots or openings on the fax as they may touch dangerous voltage points or short out parts. This could result in fire or electric shock.
- Do not allow small objects (such as pins, paper clips, or staples) to fall into the fax. If something does fall into the fax, unplug it immediately and contact your local authorised Canon dealer or the Canon help line.
- To avoid spillage in or around the fax, do not eat or drink near it. If you spill liquid or if any substance falls into the fax, unplug the fax immediately and contact your local authorised Canon dealer or the Canon help line.
- Keep the fax clean. Dust accumulation can prevent the fax from operating properly.
- Unplug the fax from the wall outlet and refer service to qualified personnel under the following conditions:
 - When the power cord or plug is damaged or frayed.
 - If liquid has spilled into the fax.
 - If the fax has been exposed to rain or water.
 - If the fax does not operate normally when you have followed the instructions in this guide. Adjust only those controls that are covered by the instructions in this guide. Improper adjustment of other controls may result in damage and may require extensive work by a qualified technician to restore the product to normal operation.
 - If the fax has been dropped or the body has been damaged.
 - If the fax exhibits a distinct change in performance, indicating a need for servicing.

■ Location

- Place the fax on a flat, stable, vibration-free surface.
- Place the fax in a cool, dry, clean, well ventilated place.
 - Make sure the area is free from dust.
 - Make sure the location is not affected by extreme temperature changes, and always stays between 10° and 32.5°C.
 - Make sure the area's relative humidity is always between 20% and 85%.
- Keep the fax away from direct sunlight.
- Do not use the fax near water. Make sure that no wet or humid objects come into contact with the fax.
- Do not use or store the fax outdoors.
- Do not install the fax near devices that contain magnets or generate magnetic fields, such as speakers.
- Place the fax near a standard 200_240 V AC power outlet.
- To ensure reliable operation of the fax and to protect it from overheating, do not block the exhaust vent and never block or cover any openings on the fax by placing it on a bed, sofa, rug, or other similar surface. Do not place the fax in a cupboard or built-in installation, or near a radiator or other heat source unless proper ventilation is provided. Install the fax approximately 10 cm away from walls and other equipment. For the dimensions of the fax, see p. S-1.
- Do not stack boxes or furniture around the power outlet. Keep the area free so you can reach the outlet quickly. If you notice anything unusual (smoke, strange odours, noises) around the fax, unplug it immediately. Contact your local authorised Canon dealer or the Canon help line.
- Do not allow anything to rest on the power cord, and do not place the fax where the cord will be walked on. Make sure the cord is not knotted or kinked.

■ Power supply

- During electrical storms, disconnect the power cord from the power outlet. (Please note that any documents stored in the fax's memory will be deleted when you unplug the fax.)
- Whenever you unplug the fax, wait at least five seconds before you plug it in again.
- If dust accumulates around the plug of the power cord when it is connected to a power outlet, unplug the fax and wipe the plug with a clean, dry cloth.



This product emits low level magnetic flux.

If you use a cardiac pacemaker and feel abnormalities, please move away from this product and consult your doctor.

