

1 Installing the software

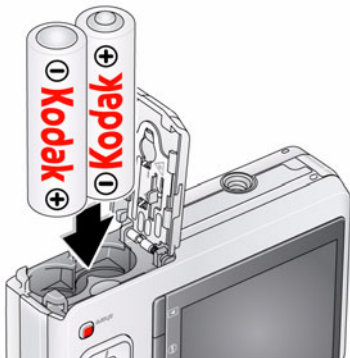

Before connecting any cables, install the software that was included with your camera. Follow the on-screen instructions.

After installing the software, return to this user guide.

2 Loading the batteries



See the Extended user guide

www.kodak.com/go/c160support,
www.kodak.com/go/c180support

3 Turning on the camera

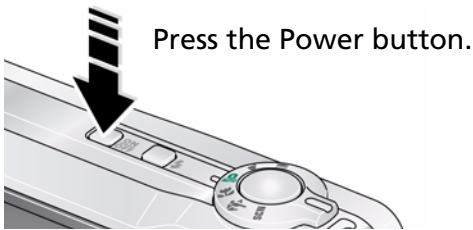

4 Setting the language and date/time

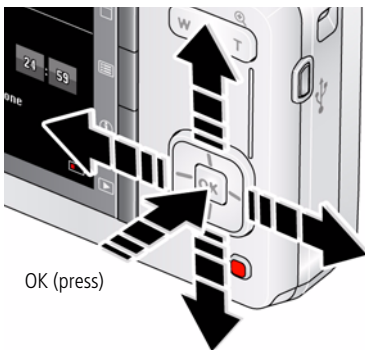

Language:

▲/▼ to change.

OK to accept.

Date/Time:

At the prompt, press OK.

▲/▼ to change current field.

◀/▶ for previous/next field.

OK to accept.

See the Extended user guide

www.kodak.com/go/c160support,
www.kodak.com/go/c180support

5 Taking a picture

- 1 Turn the Mode dial to Auto  .
Compose the picture.
- 2 Press the Shutter button halfway to focus and set exposure.
When the framing marks turn green, press the Shutter button completely down.



To learn more about Auto and other modes, see [page 10](#).

See the Extended user guide

www.kodak.com/go/c160support,
www.kodak.com/go/c180support

6 Reviewing pictures/videos



Press the Review  button to enter/exit Review.

-  View previous/next picture/video.
- OK Play a video.

See the Extended user guide

www.kodak.com/go/c160support,
www.kodak.com/go/c180support

7 Transferring pictures/videos

- 1 Connect a KODAK USB Cable, Model U-8.
- 2 Turn on the camera.

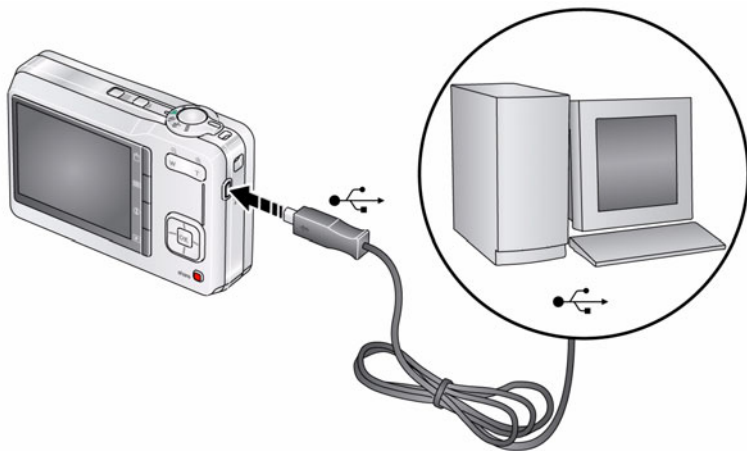

See the Extended user guide

www.kodak.com/go/c160support,
www.kodak.com/go/c180support

Purchase accessories

www.kodak.com/go/c160accessories,
www.kodak.com/go/c180accessories

8 Getting help from your camera

You want the most from your camera. You want to understand:

- What it can do for you
- And how to take the best possible pictures and videos

Great news!

Your camera offers a built-in Help system. It describes every setting for every menu choice. If you learn nothing else about your camera, learn how to use on-camera Help. Because the more you know your camera, the more confident you become.



① Press the Menu button  then highlight a menu choice.

② Press the Info  button.

 Scroll through a Help topic

See the Extended user guide

www.kodak.com/go/c160support,
www.kodak.com/go/c180support

9 Keep learning about your camera!

Congratulations!

You have:

- set up your camera
- taken pictures
- transferred pictures to your computer

Keep learning!

Finish reading this book, so you can take and share your best pictures!

**Visit www.kodak.com/go/c160support
or www.kodak.com/go/c180support:**

- the extended user guide
- interactive troubleshooting and repairs
- interactive tutorials
- FAQs
- downloads
- accessories
- printing information
- product registration



See the Extended user guide

www.kodak.com/go/c160support,
www.kodak.com/go/c180support

Front View

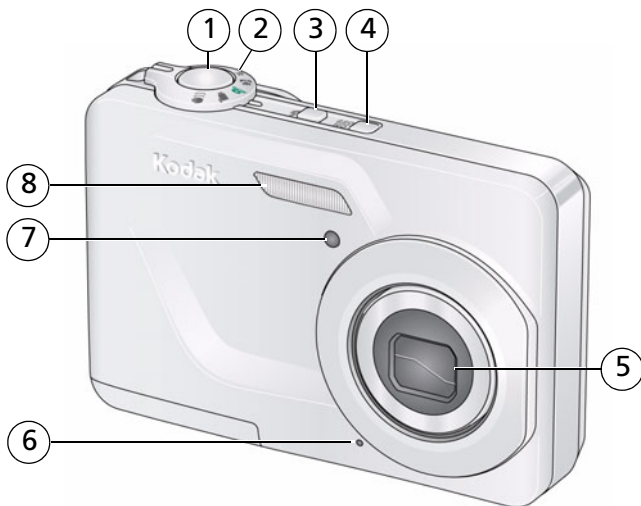

- | | | | |
|---|----------------|---|------------------|
| 1 | Shutter button | 5 | Lens/Lens cover |
| 2 | Mode dial | 6 | Microphone |
| 3 | Flash button | 7 | Self-timer light |
| 4 | Power button | 8 | Flash |

Back View

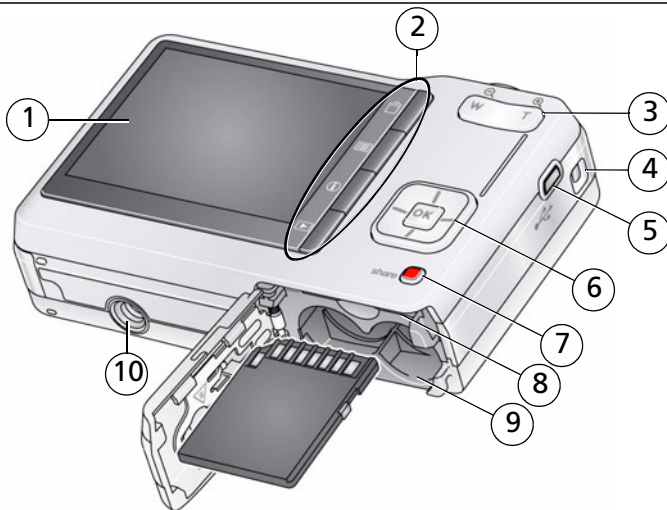







- | | | | |
|---|------------------------------------|----|---------------------|
| 1 | LCD | 6 | ▲/▼ ◀/▶, OK button |
| 2 | Delete, Menu, Info, Review buttons | 7 | Share button |
| 3 | Zoom (Telephoto/Wide Angle) button | 8 | SD/SDHC Card slot |
| 4 | Strap post | 9 | Battery compartment |
| 5 | USB port | 10 | Tripod socket |

1

Doing more with your camera



Turn the Mode dial to the mode that best suits your subjects and surroundings.

Use this mode	For
 Auto	General picture taking—it offers excellent image quality and ease of use. The scene is analyzed for other content and for lighting. You can choose the best picture size and aspect ratio for your needs—just press the Menu  button and choose Picture Size.
 Close-Up	Close range. Use available light instead of flash, if possible.
 Sport	Subjects that are in motion.
SCN Scene	Point-and-shoot simplicity when taking pictures in practically any situation. (See page 11 .)
 Blur Reduction	Reducing blur caused by camera shake or subject motion.
 Video	Capturing video with sound. (See page 11 .) NOTE: Sound cannot be played on the camera. Sound is heard after the video is transferred to your computer.



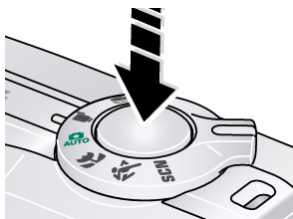

Taking a video



- 1 Turn the Mode dial to Video .
- 2 Press the Shutter button **completely down**, then release it. To stop recording, press and release the Shutter button again.
To review videos, see [page 18](#).

Using Scene (SCN) modes

Choose a Scene mode—for great pictures in practically any situation.

- 1 Turn the Mode dial to SCN.
- 2 Press     to view scene mode descriptions.
If the mode description turns off before you finish reading it, press OK.
- 3 Press OK to choose a Scene mode.

SCN mode	For
Portrait	Full-frame portraits of people.
Landscape	Distant scenes.
Flower	Close-ups of flowers or other small subjects in bright light.
Sunset	Subjects at dusk.
Backlight	Subjects that are in shadow or “backlit” (when light is behind the subject).

Doing more with your camera

SCN mode	For
Candle Light	Subjects illuminated by candle light.
Children	Action pictures of children in bright light.
Manner/ Museum	Quiet occasions, like a wedding or lecture. Flash and sound are disabled. Place the camera on a steady surface or tripod.
Text	Documents. Place the camera on a steady surface or tripod.
Beach	Bright beach scenes.
Snow	Bright snow scenes.
Fireworks	Fireworks. Place the camera on a steady surface or tripod.
Self- Portrait	Close-ups of yourself. Assures proper focus and minimizes red eye.
Night Portrait	Reduces red eye of people in night scenes or low-light conditions.
Night Landscape	Distant scenery at night. Flash does not fire.
High ISO	People indoors, in low-light scenes.

Using the optical zoom

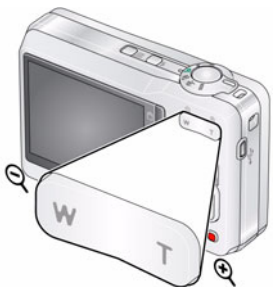

- 1 Use the LCD to frame your subject.
- 2 To zoom in, press Telephoto (T).
To zoom out, press Wide Angle (W).
- 3 Take the picture.

Using digital zoom





Use digital zoom to get up to 5X magnification beyond optical zoom. Press Telephoto (T) until the slider on the LCD is at the maximum optical zoom range. Release Telephoto (T), then press it again.

NOTE: You may notice decreased image quality when using digital zoom. The slider pauses and turns red when the picture quality reaches the limit for an acceptable 4 x 6-in. (10 x 15 cm) print.

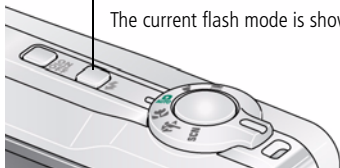
Using the flash

Press the flash button repeatedly to scroll through flash modes.
The current flash mode is shown on the LCD.



Flash modes		Flash fires
Auto		When the lighting conditions require it.
Fill (Flash On)		Every time you take a picture, regardless of the lighting conditions. Use when the subject is in shadow or is "backlit" (when the light is behind the subject). In low light, hold the camera steady or use a tripod.
Red Eye	Preflash 	A preflash fires, shrinking the eye pupil, before the picture is taken.
Your camera can correct red-eye using 2 methods. To choose a red eye setting, press the Menu button, then see the Setup Menu.	Digital Correction 	A preflash does not fire; the camera corrects red eye.
Off		Never

Using shortcuts

Your camera has a clean, uncluttered interface. For quick access to the most popular functions:

- 1 Press the Info **i** button.

The shortcuts appear.

- 2 Press **◀/▶** to access functions like Exposure Compensation, Self-timer, and Auto focus. (You'll see different functions in different modes.)
- 3 Press **▲/▼** to choose a setting.

To hide the shortcuts again, press **i**.







Using the menu button to change settings

IMPORTANT: *Your camera offers a built-in Help system. To get the most from your camera, see [page 6](#).*

You can change settings to get the best results from your camera.

NOTE: Some modes offer limited settings. Some settings remain until you change them; others, until you change modes or turn off the camera.

- 1 Press the Menu  button.
- 2 Press  to highlight a tab:
 - **Capture/Video** for the most common picture/video-taking settings
 - **Setup** for other camera settings
- 3 Press  to highlight a setting, then press OK.
- 4 Highlight an option, then press OK. (Some options let you use  to choose a setting.)

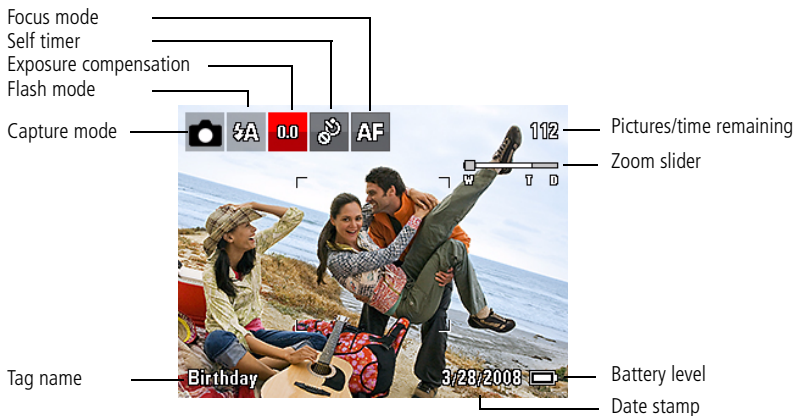

Understanding the picture-taking icons





2

Working with pictures/videos

Deleting pictures/videos

- 1 Press the Review  button.
- 2 Press  for previous/next picture/video.
- 3 Press the Delete  button.
- 4 Follow the screen prompts.

Viewing pictures as thumbnails

- 1 Press the Review  button.
The camera shows the last picture that was taken.
- 2 Press the Wide Angle (W) button to view pictures/videos as thumbnails. (Press it again to see more, smaller thumbnails.)
To view all pictures/videos, highlight the All tab.
To sort by favorites, date, or tagged pictures/videos, press  and highlight the appropriate tab.
- 3 To see a single picture/video, press  to highlight it. Then press Telephoto (T).
 - Press the Shutter button halfway down to return to Capture mode.

Understanding the review icons

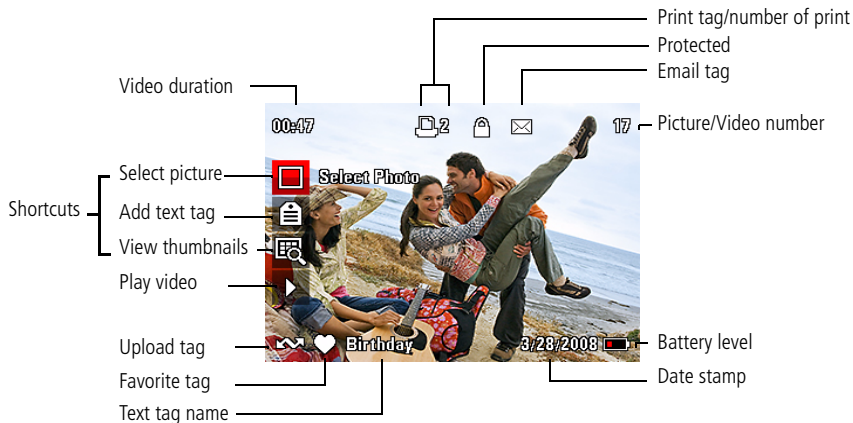

For more about shortcuts, see [page 15](#).

3 Share your stories!

A thousand ways to tell a story...
and each begins with a picture.



How do you tell yours?

Prints	Photo gifts	Digitally
<ul style="list-style-type: none">• 4 x 6 pictures• Enlargements, posters• Collages• Photo books	<ul style="list-style-type: none">• Cards• Calendars• Mugs• Ties• Shirts	<ul style="list-style-type: none">• EASYSHARE Digital Picture Frame• HDTV devices• Email <p>...and much more!</p>

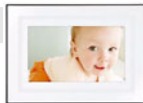
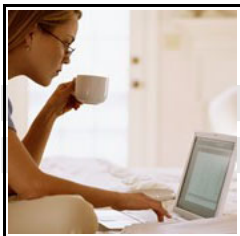

Pictures start here!

①

Load
KODAK
EASYSHARE
Software.



②

Take pictures.



③

Transfer
pictures
to your
computer.



Pictures become stories here!

— At home ———— Online ——— At a local photo retailer —



KODAK All-in-One
Printers



KodakGallery



KODAK Picture Kiosk

www.kodak.com/go/tips

4

Solving camera problems

Camera problems

Status	Solution
Camera does not turn on	■ Make sure the batteries are charged and installed correctly (see page 1).
Camera does not turn off	■ Turn the camera off, then on again.
Camera buttons and controls do not function	
In Review, a blue or black screen is displayed instead of a picture	■ Transfer <i>all</i> pictures to the computer (see page 5). ■ Take another picture.
Pictures remaining number does not decrease after taking a picture	■ Continue taking pictures. The camera is operating normally. (The camera estimates the number of pictures remaining after each picture is taken, based on picture size and content.)
Flash does not fire	■ Check the flash setting, and change as needed (see page 14). NOTE: The flash does not fire in all modes.
Memory card is almost or entirely full	■ Transfer the pictures to the computer (see page 5). ■ Delete pictures from the card (see page 18) or insert a new card.

5 Appendix



CAUTION:

Do not disassemble this product; there are no user-serviceable parts inside. Refer servicing to qualified service personnel. KODAK AC Adapters and Battery Chargers are intended for indoor use only. The use of controls, adjustments, or procedures other than those specified herein may result in exposure to shock and/or electrical or mechanical hazards. If the LCD breaks, do not touch the glass or liquid. Contact Kodak customer support.

- The use of an accessory that is not recommended by Kodak may cause fire, electric shock, or injury. For approved accessories, visit www.kodak.com/go/accessories.
- Use only a USB-certified computer equipped with a current-limiting motherboard. Contact your computer manufacturer if you have questions.
- If using this product in an airplane, observe all instructions of the airline.
- When removing the battery, allow it to cool; it may be hot.
- Follow all warnings and instructions supplied by the battery manufacturer.
- Use only batteries approved for this product to avoid risk of explosion.
- Keep batteries out of the reach of children.
- Do not allow batteries to touch metal objects, including coins. Otherwise, a battery may short circuit, discharge energy, become hot, or leak.
- Do not disassemble, install backward, or expose batteries to liquid, moisture, fire, or extreme temperature.
- Remove the battery when the product is stored for an extended period of time. In the unlikely event that battery fluid leaks inside the product, contact Kodak customer support.
- In the unlikely event that battery fluid leaks onto your skin, wash immediately with water and contact your local health provider. For additional health-related information, contact your local Kodak customer support.
- Dispose of batteries according to local and national regulations. Visit www.kodak.com/go/kes.
- Do not charge non-rechargeable batteries.

For more information on batteries, see www.kodak.com/go/batterytipes.

Limited Warranty

Kodak warrants Kodak consumer electronic products and accessories ("products"), excluding batteries, to be free from malfunctions and defects in both materials and workmanship for one year from the date of purchase. Retain the original dated sales receipt. Proof of the date of purchase will be required with any request for warranty repair.

Limited warranty coverage

Warranty service is only available from within the country where the products were originally purchased. You may be required to ship products, at your expense, to the authorized service facility for the country where the products were purchased. Kodak will repair or replace products if they fail to function properly during the warranty period, subject to any conditions and/or limitations stated herein. Warranty service will include all labor as well as any necessary adjustments and/or replacement parts. If Kodak is unable to repair or replace a product, Kodak will, at its option, refund the purchase price paid for the product provided the product has been returned to Kodak along with proof of the purchase price paid. Repair, replacement, or refund of the purchase price are the sole remedies under the warranty. If replacement parts are used in making repairs, those parts may be remanufactured, or may contain remanufactured materials. If it is necessary to replace the entire product, it may be replaced with a remanufactured product. Remanufactured products, parts and materials are warranted for the remaining warranty term of the original product, or 90 days after the date of repair or replacement, whichever is longer.

Limitations

This warranty does not cover circumstances beyond Kodak's control. This warranty does not apply when failure is due to shipping damage, accident, alteration, modification, unauthorized service, misuse, abuse, use with incompatible accessories or attachments (such as third party ink or ink tanks), failure to follow Kodak's operation, maintenance or repacking instructions, failure to use items supplied by Kodak (such as adapters and cables), or claims made after the duration of this warranty. **Kodak makes no other express or implied warranty for this product, and disclaims the implied warranties of merchantability and fitness for a particular purpose.** In the event that the exclusion of any implied warranty is ineffective under the law, the duration of the implied warranty will be one year from the purchase date or such longer period as required by law. The option of repair, replacement, or refund is Kodak's only obligation. Kodak will not be responsible for any special, consequential or incidental damages resulting from the sale, purchase, or use of this product regardless of the cause. Liability for any special, consequential or incidental damages (including but not limited to loss of revenue or profit, downtime costs, loss of the use of the equipment, cost of substitute equipment, facilities or services, or claims of your customers for such damages resulting from the purchase, use, or failure of the product), regardless of cause or for breach of any written or implied warranty is expressly disclaimed.

Your rights

Some states or jurisdictions do not allow exclusion or limitation of incidental or consequential damages, so the above limitation or exclusion may not apply to you. Some states or jurisdictions do not allow limitations on how long an implied warranty lasts, so the above limitation may not apply to you. This warranty gives you specific rights, and you may have other rights which vary from state to state or by jurisdiction.

Outside the United States and Canada

In countries other than the United States and Canada, the terms and conditions of this warranty may be different. Unless a specific Kodak warranty is communicated to the purchaser in writing by a Kodak company, no warranty or liability exists beyond any minimum requirements imposed by law, even though defect, damage, or loss may be by negligence or other act.

FCC compliance and advisory



This equipment has been tested and found to comply with the limits for a Class B digital device, pursuant to Part 15 of the FCC Rules. These limits are designed to provide reasonable protection against harmful interference in a residential installation. This equipment generates, uses, and can radiate radio frequency energy and, if not installed or used in accordance with the instructions, may cause harmful interference to radio communications. However, there is no guarantee that interference will not occur in a particular installation. If this equipment does cause harmful interference to radio or television reception, which can be determined by turning the equipment off and on, the user is encouraged to try to correct the interference by one or more of the following measures: 1) reorient or relocate the receiving antenna; 2) increase the separation between the equipment and the receiver; 3) connect the equipment to an outlet on a circuit different from that to which the receiver is connected; 4) consult the dealer or an experienced radio/TV technician for additional suggestions. Any changes or modifications not expressly approved by the party responsible for compliance could void the user's authority to operate the equipment. Where shielded interface cables have been provided with the product or specified additional components or accessories elsewhere defined to be used with the installation of the product, they must be used in order to ensure compliance with FCC regulation.

Canadian DOC statement

DOC Class B Compliance—This Class B digital apparatus complies with Canadian ICES-003.

Observation des normes-Classe B—Cet appareil numérique de la classe B est conforme à la norme NMB-003 du Canada.

FCC and Industry Canada

This device complies with Industry Canada RSS-210 and FCC Rules. Operation is subject to the following two conditions: (1) this device may not cause harmful interference, and (2) this device must accept any interference received, including interference that may cause undesired operation.

FCC et Industrie Canada

Cet appareil est conforme à la norme RSS-210 d'Industrie Canada et aux réglementations de la FCC. Son utilisation est soumise aux deux conditions suivantes : (1) cet appareil ne doit pas provoquer d'interférences nuisibles, et (2) cet appareil doit supporter les interférences reçues, y compris celles susceptibles de nuire à son bon fonctionnement.

Waste Electrical and Electronic Equipment labeling



In Europe: For human/environmental protection, it is your responsibility to dispose of this equipment at a collection facility established for this purpose (separate from municipal waste). For more information, contact your retailer, collection facility, or appropriate local authorities; or visit www.kodak.com/go/recycle.

VCCI Class B ITE

この装置は、情報処理装置等電波障害自主規制協議会（VCCI）の基準に基づくクラスB情報技術装置です。この装置は、家庭環境で使用すること目的としていますが、この装置がラジオやテレビジョン受信機に近接して用されると、受信障害を引き起こすことがあります。
取扱説明書に従って正しい取り扱いをして下さい。

Australian C-Tick



Korean Class B ITE

B급 기기 (가정용 방송통신기기)	이 기기는 가정용(B급)으로 전자파적합등록을 한 기기로서 주로 가정에서 사용하는 것을 목적 으로 하며, 모든 지역에서 사용할 수 있습니다.
-----------------------	---

China RoHS

环保使用期限 (EPUP)

在中国大陆, 该值表示产品中存在的任何危险物质不得释放, 以免危及人身健康、财产或环境的时间期限(以年计)。该值根据操作说明中所规定的产品正常使用而定。

有毒有害物质或元素名称及含量标识表						
部件名称	有毒有害物质或元素					
	铅	汞	镉	六价铬	多溴联苯	多溴二苯醚
数码相机电路板元件	×	○	○	○	○	○

○: 表示该有毒有害物质在该部件所有均质材料中的含量均在SJ/T 11363-2006规定的限量要求以下。
 ×: 表示该有毒有害物质至少在该部件的某一均质材料中的含量超出SJ/T 11363-2006规定的限量要求。



USB 数据线

Kodak

Eastman Kodak Company

Rochester, New York 14650

© Eastman Kodak Company, 2008

Kodak, EasyShare, and Perfect Touch are trademarks of Eastman Kodak Company.

4H5116_en

www.kodak.com/go/c180support