

SHARP

COMPACT AUDIO SYSTEM

MODEL

XL-3000W

OPERATION MANUAL

COMPACT
disc
DIGITAL AUDIO

SAVING ENERGY
STAND-BY POWER
CONSUMPTION **0.8W**

XL3000A(FRONT)

1



**Thank you for purchasing this SHARP product.
To obtain the best performance from this product, please
read this manual carefully. It will guide you in operating
your SHARP product.**

XL-3000W Compact Audio System consisting of XL-3000W
(main unit) and CP-XL3000H (speaker system).

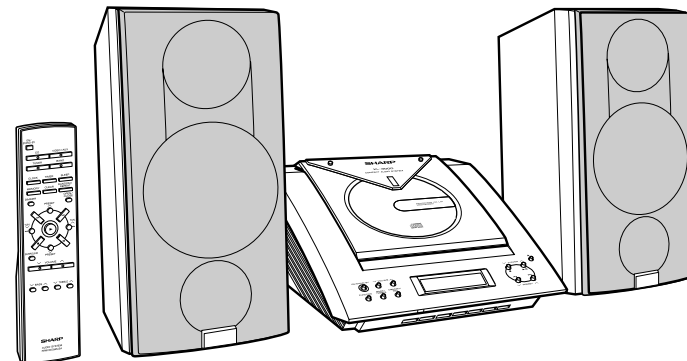

2001.6.6, 2:18 PM

Special Notes

CAUTION



- This Compact Audio System is classified as a CLASS 1 LASER product.
- The CLASS 1 LASER PRODUCT label is located on the rear cover.
- Use of controls, adjustments or performance of procedures other than those specified herein may result in hazardous radiation exposure.

As the laser beam used in this compact disc player is harmful to the eyes, do not attempt to disassemble the cabinet. Refer servicing to qualified personnel only.

Laser Diode Properties
Material: GaAlAs
Wavelength: 780 nm
Emission Duration: continuous
Laser Output: max. 0.6 mW

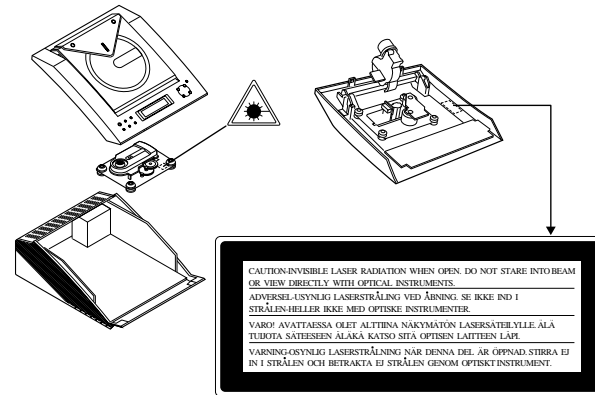

When the ON/STAND-BY button is set at STAND-BY position, mains voltage is still present inside the unit. When the ON/STAND-BY button is set at STAND-BY position, the unit may be brought into operation by the timer mode or remote control.

Warning:



This unit contains no user serviceable parts. Never remove covers unless qualified to do so. This unit contains dangerous voltages, always remove mains plug from the socket before any service operation and when not in use for a long period.

Warning:

To prevent fire or shock hazard, do not expose this appliance to dripping or splashing. No objects filled with liquids, such as vases, shall be placed on the apparatus.

Accessories

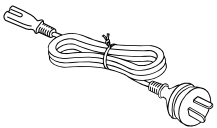
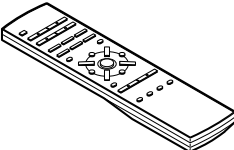
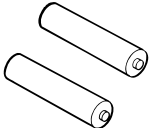
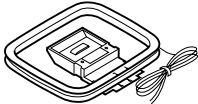
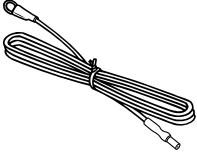
Please confirm that the following accessories are included.

 <p>AC power lead × 1</p>	 <p>Remote control × 1</p>
 <p>"AAA" size battery (UM-4, R03, HP-16 or similar) × 2</p>	 <p>AM loop aerial × 1</p>
 <p>FM aerial × 1</p>	 <p>Speaker wire × 2</p>

Note:
Only the above accessories are included.

Contents

	Page
■ General Information	
Precautions	3
Controls and Indicators	4 - 6
■ Preparation for Use	
System Connections	7 - 10
Remote Control	11
■ Basic Operation	
General Control	12
Sound Control	13
Setting the Clock	14
■ CD Playback	
Listening to a CD	15 - 17
Repeat or Random Play	17
Programmed Play	18
■ Radio	
Listening to the Radio	19
Listening to the Memorised Station	20
■ Advanced Features	
Timer and Sleep Operation	21 - 23
Enhancing Your System	24
■ References	
Troubleshooting	25
Maintenance	25
Specifications	26

Precautions

■ General

- Please ensure that the equipment is positioned in a well-ventilated area and that there is at least 10 cm (4") of free space along the sides and back. There must also be a minimum of 30 cm (12") of free space on the top of the unit.

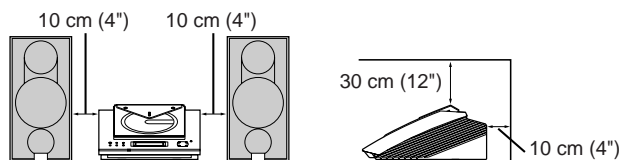

- Use the unit on a firm, level surface free from vibration.
- Keep the unit away from direct sunlight, strong magnetic fields, excessive dust, humidity and electronic/electrical equipment (home computers, facsimiles, etc.) which generates electrical noise.
- Do not place anything on top of the unit.
- Do not expose the unit to moisture, to temperatures higher than 60°C (140°F) or to extremely low temperatures.
- If your system does not work properly, disconnect the AC power lead from the wall socket. Plug the AC power lead back in, and then turn on your system.
- In case of an electrical storm, unplug the unit for safety.
- Hold the AC power plug by the head when removing it from the wall socket, as pulling the lead can damage internal wires.
- **Do not remove the outer cover, as this may result in electric shock. Refer internal service to your local SHARP service facility.**
- The ventilation should not be impeded by covering the ventilation openings with items, such as newspapers, tablecloths, curtains, etc.
- No naked flame sources, such as lighted candles, should be placed on the apparatus.

- Attention should be drawn to the environmental aspects of battery disposal.
- This unit should only be used within the range of 5°C - 35°C (41°F - 95°F).

Warnings:

- The voltage used must be the same as that specified on this unit. Using this product with a higher voltage other than that which is specified is dangerous and may result in a fire or other type of accident causing damage. SHARP will not be held responsible for any damage resulting from use of this unit with a voltage other than that which is specified.
- **CD players use a laser pickup which can damage the eyes if viewed directly. Do not look at the pickup, and do not touch the pickup directly.**
- This product is equipped with a cooling fan inside, which begins to run at a specified volume level for better heat radiation.

■ Volume control

The sound level at a given volume setting depends on speaker efficiency, location, and various other factors. It is advisable to avoid exposure to high volume levels, which occurs whilst turning the unit on with the volume control setting up high, or whilst continually listening at high volumes.

■ Condensation

Sudden temperature changes, storage or operation in an extremely humid environment may cause condensation inside the cabinet (CD pickup, etc.) or on the transmitter or the remote control. Condensation can cause the unit to malfunction. If this happens, leave the power on with no disc in the unit until normal playback is possible (about 1 hour). Wipe off any condensation on the transmitter with a soft cloth before operating the unit.



Controls and Indicators

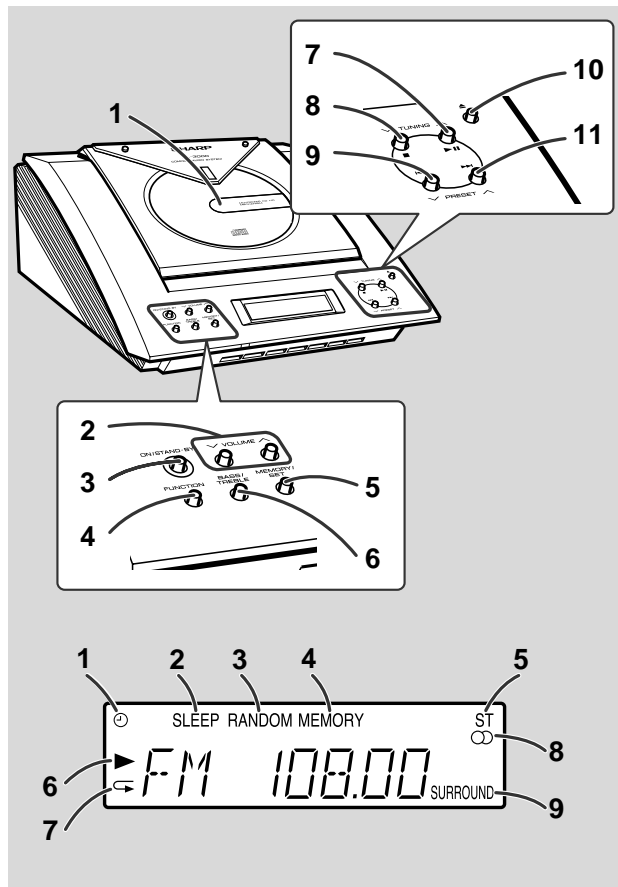

■ Front panel

	Reference page
1. CD Compartment	12, 15
2. Volume Up and Down Buttons	13
3. On/Stand-by Button	12
4. Function Selector Button	15, 19, 21
5. Memory/Set Button	18, 20
6. Bass/Treble Selector Button	13
7. CD Play or Pause, Tuning Up Button	15, 16, 19
8. CD Stop, Tuning Down Button	16, 19
9. CD Track Down or Fast Reverse, Tuner Preset Down Button	17, 20
10. CD Open/Close Button	12
11. CD Track Up or Fast Forward, Tuner Preset Up Button	17, 20

■ Display

1. Timer Play Indicator
2. Sleep Indicator
3. CD Random Play Indicator
4. Memory Indicator
5. FM Stereo Mode Indicator
6. CD Play Indicator
7. CD Repeat Play Indicator
8. FM Stereo Receiving Indicator
9. Surround Indicator

■ Description of remote control (See page 6.)

Controls and Indicators (continued)

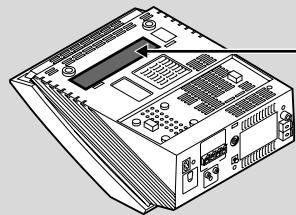
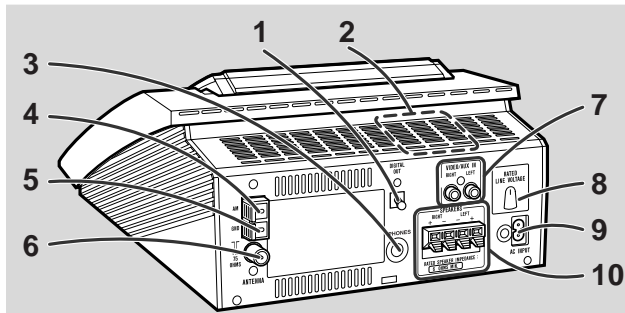

The rating label is located on the bottom of the unit.

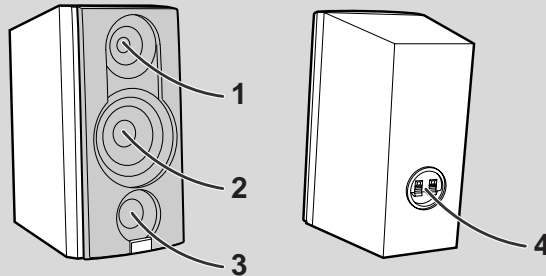

■ Rear panel

	Reference page
1. CD Digital Output Socket	24
2. Cooling Fan	3
3. Headphone Socket	24
4. AM Aerial Terminal	7, 8
5. Aerial Earth Terminal	7, 8
6. FM 75 Ohms Aerial Socket	7, 8
7. Video/Auxiliary (Audio Signal) Input Sockets	24
8. AC Voltage Selector	7, 9
9. AC Power Input Socket	7, 9
10. Speaker Terminals	7, 8

■ Speaker system

1. Tweeter
2. Woofer
3. Bass Reflex Duct
4. Speaker Terminals

Speaker grilles are removable:

Make sure nothing comes into contact with the speaker diaphragms when you remove the speaker grilles.

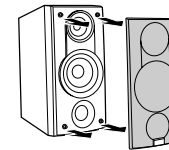

Placing the speaker system:

There is no distinction between the right and the left speakers.

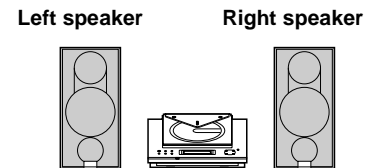

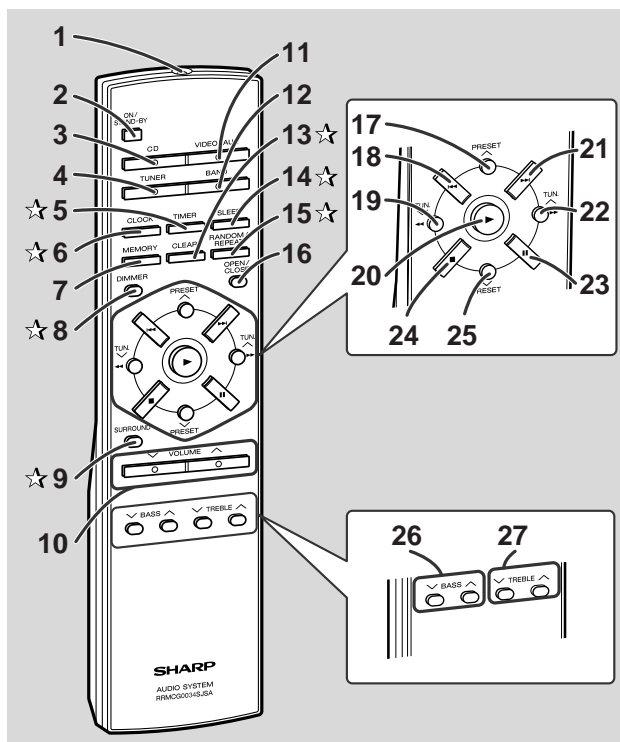

Buttons with "☆" mark in the illustration can be operated on the remote control only. Other buttons can be operated both on the main unit and the remote control.

■ Remote control

	Reference page
1. Remote Control Transmitter	11
2. On/Stand-by Button	12
3. CD Button	15
4. Tuner Button	19
5. Timer Button	21
6. Clock Button	14, 21
7. Memory Button	14, 18, 20
8. Dimmer Button	12
9. Surround Button	13
10. Volume Up and Down Buttons	13
11. Video/Auxiliary Button	21
12. Band Selector Button	19
13. Clear Button	18
14. Sleep Button	23
15. Random/Repeat Button	17
16. CD Open/Close Button	12
17. Tuner Preset Up Button	20
18. CD Track Down Button	17
19. CD Fast Reverse, Tuning Down Button	17, 19
20. CD Play Button	15
21. CD Track Up Button	17
22. CD Fast Forward, Tuning Up Button	17, 19
23. CD Pause Button	16
24. CD Stop Button	16
25. Tuner Preset Down Button	20
26. Bass Up and Down Buttons	13
27. Treble Up and Down Buttons	13

■ Battery installation for remote control (See page 11.)

System Connections

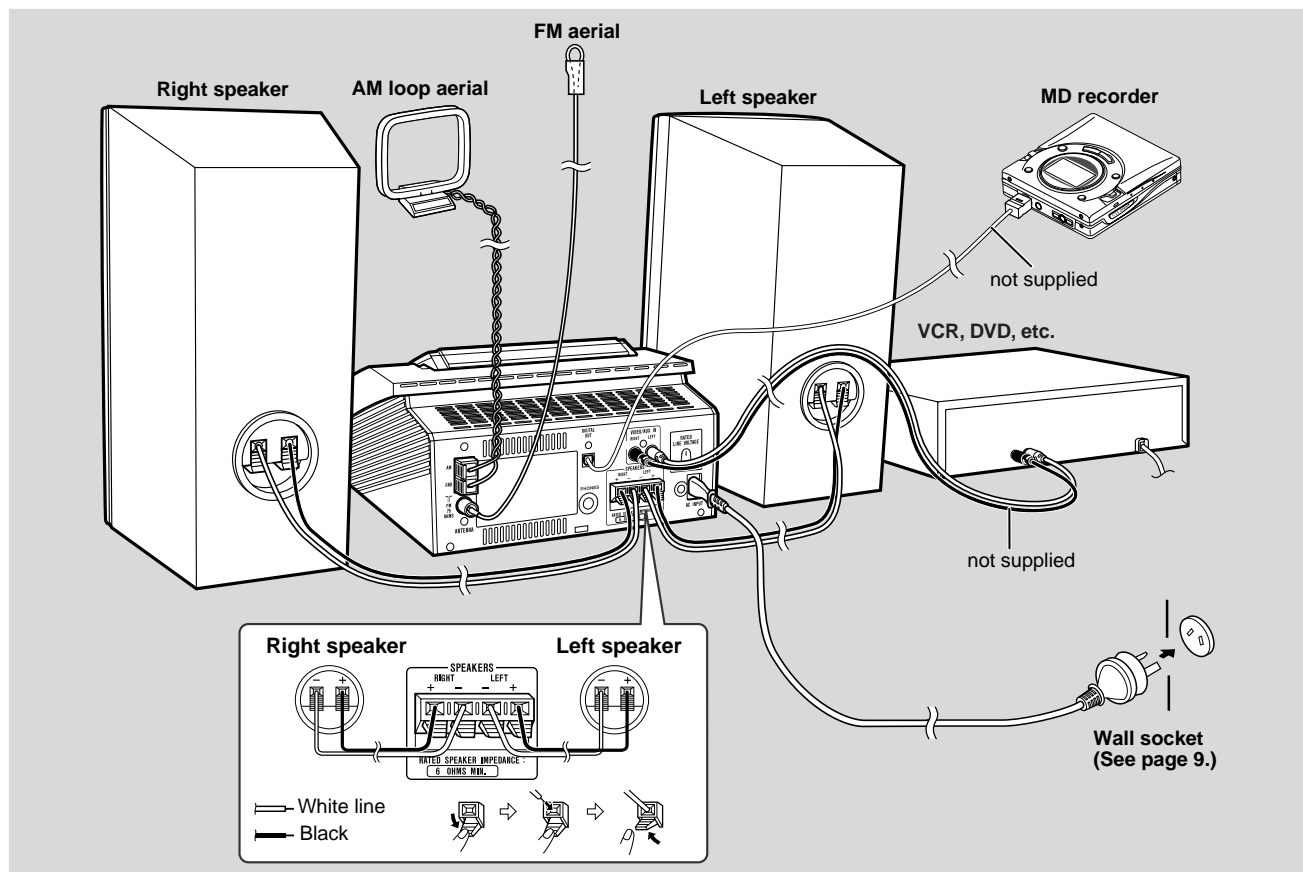

■ Aerial connection

Supplied FM aerial:

Connect the FM aerial wire to the FM 75 OHMS socket and position the FM aerial wire in the direction where the strongest signal can be received.

Supplied AM loop aerial:

Connect the AM loop aerial wire to the AM and GND terminals. Position the AM loop aerial for optimum reception. Place the AM loop aerial on a shelf, etc., or attach it to a stand or a wall with screws (not supplied).

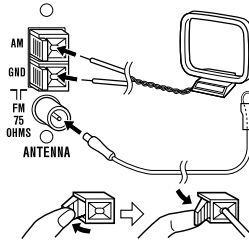

Notes:

- Placing the aerial on the unit or near the AC power lead may cause noise pickup. Place the aerial away from the unit for better reception.
- When static is still heard even after adjusting the position of the AM loop aerial, try reversing the wire connections.

Installing the AM loop aerial:

< Assembling >

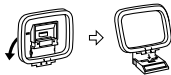

< Attaching to the wall >



External FM or AM aerial:

Use an external FM or AM aerial if you require better reception. Consult your dealer.

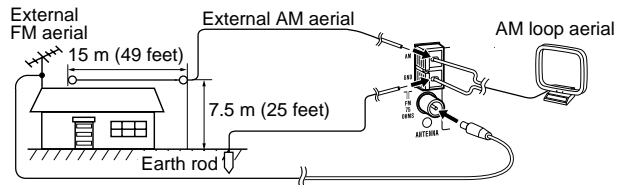

Notes:

- When an external FM aerial is used, disconnect the supplied FM aerial wire from the FM 75 OHMS socket.
- When using an external AM aerial, be sure to keep the wire of the AM loop aerial connected.

■ Speaker connection

Connect the wire with the white line to the minus (-) terminal and the black wire to the plus (+) terminal.

Caution:

- **Connect the speaker wires to the speakers first, then to the unit.**
- Use speakers with an impedance of 6 ohms or more, as lower impedance speakers can damage the unit.
- Do not mistake the right and the left channels. The right speaker is the one on the right side when you face the unit.
- **Do not let the bare speaker wires touch each other.**

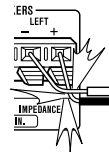

Incorrect

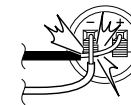

Incorrect

System Connections (continued)

■ Setting the AC voltage selector

Check the setting of the AC voltage selector located on the rear panel before plugging the unit into a wall socket. If necessary, adjust the selector to correspond to the AC power voltage used in your area.

Turn the selector with a screwdriver until the appropriate voltage number appears in the window (110 V, 127 V, 220 V or 230 V - 240 V AC).

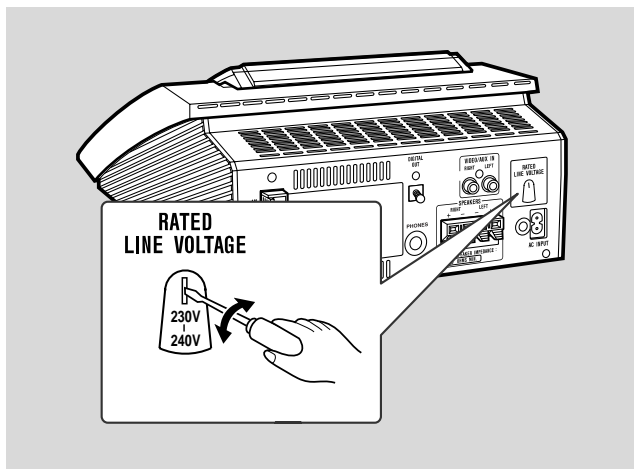

■ Connecting the AC power lead

After checking all the connections have been made correctly, connect the AC power lead to the AC power input socket, then into the wall socket.

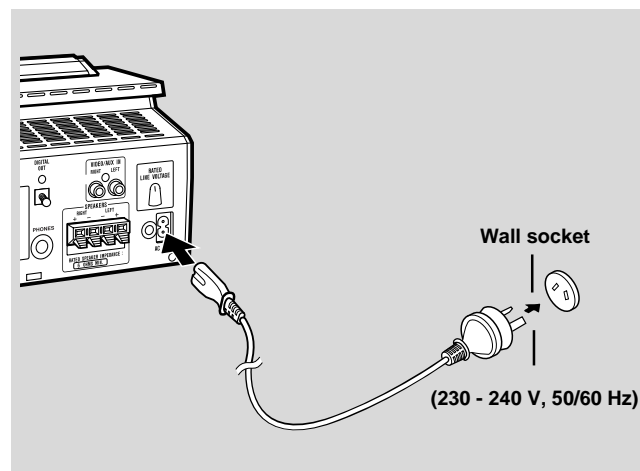

Notes:

- Unplug the AC power lead from the wall socket if the unit will not be in use for a prolonged period of time.
- **Never use a power lead other than the one supplied. Use of a power lead other than the one supplied may cause an electric shock or fire.**

■ Setting the AM/FM interval

The International Telecommunication Union (ITU) has established that member countries should maintain either a 10 kHz or 9 kHz interval between broadcasting frequencies of AM stations and 100 kHz or 50 kHz for FM stations. The illustration shows the 50/9 kHz zones (regions 1 and 3), and the 100/10 kHz zone (region 2).

This product is not equipped with a span selector. However, it will be adjusted to a 9 kHz AM (50 kHz FM) interval when shipped from the factory.

Before using the unit, be sure to set it to the AM/FM tuning interval (span) used in your area.

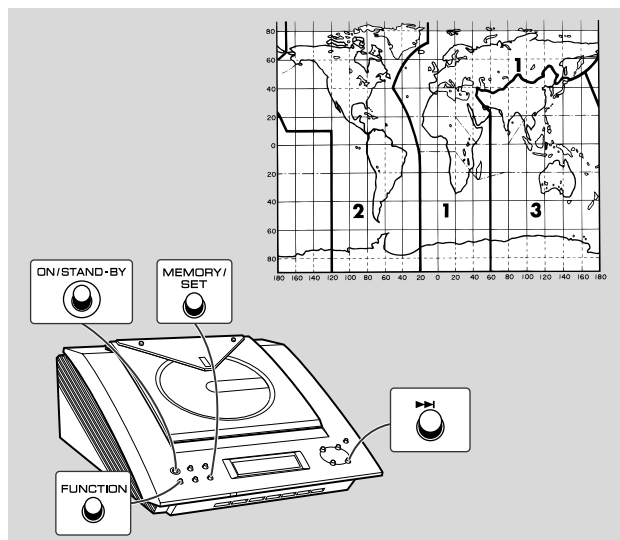

To check the tuning span currently selected:

- 1 Press the ON/STAND-BY button to turn the power on.
- 2 Press the FUNCTION button until "AM" appears on the display.
 - If "AM 531 kHz" is displayed, it means that AM stations have been adjusted for a 9 kHz span and FM stations for 50 kHz span. If "AM 530 kHz" is displayed, AM stations have been adjusted for a 10 kHz span and FM stations for 100 kHz span.

To change from a 9 kHz AM (50 kHz FM) interval to a 10 kHz AM (100 kHz FM) interval:

- 1 Press the ON/STAND-BY button to enter the stand-by mode.
- 2 Hold down the ►| button and the MEMORY/SET button for at least 4 seconds. Release the buttons when "AM SP 10 kHz" and "FM SP 100 kHz" are displayed alternately.
 - The clock display will reappear.

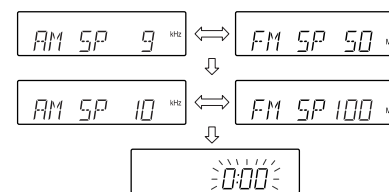

To return to a 9 kHz AM (50 kHz FM) interval:

- 1 Press the ON/STAND-BY button to enter the stand-by mode.
- 2 Hold down the ►| button and the MEMORY/SET button for at least 4 seconds. Release the buttons when "AM SP 9 kHz" and "FM SP 50 kHz" are displayed alternately.
 - The clock display will reappear.

Caution:

- When the unit is left for a few hours after the span has been switched and the AC power lead disconnected, the AM span will be automatically returned to 9 kHz (FM span to 50 kHz). If this happens, set the span again.
- When the span is switched, all the memorised stations will be cancelled.

Remote Control

■ Battery installation

- 1 Remove the battery cover.
- 2 Insert the batteries according to the direction indicated in the battery compartment.
When inserting or removing the batteries, push them towards the ⊖ battery terminals.
- 3 Replace the cover.

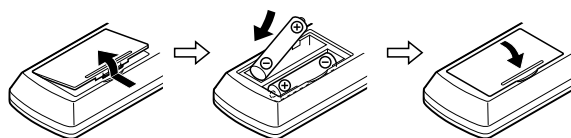

Precautions for battery use:

- Replace all old batteries with new ones at the same time.
- Do not mix old and new batteries.
- Remove the batteries if the unit will not be used for long periods of time. This will prevent potential damage due to battery leakage.

Caution:

- Do not use rechargeable batteries (nickel-cadmium battery, etc.).
- Installing the batteries incorrectly may cause the unit to malfunction.

Notes concerning use:

- Replace the batteries if the operating distance is reduced or if the operation becomes erratic. Purchase 2 "AAA" size batteries (UM-4, R03, HP-16 or similar).
- Periodically clean the transmitter on the remote control and the sensor on the unit with a soft cloth.
- Exposing the sensor on the unit to strong light may interfere with operation. Change the lighting or the direction of the unit.
- Keep the remote control away from moisture, heat, shock, and vibrations.

■ Test of the remote control

Face the remote control directly to the remote sensor on the unit.

The remote control can be used within the range shown below:
Press the ON/STAND-BY button. Does the power turn on? Now, you can enjoy the music.

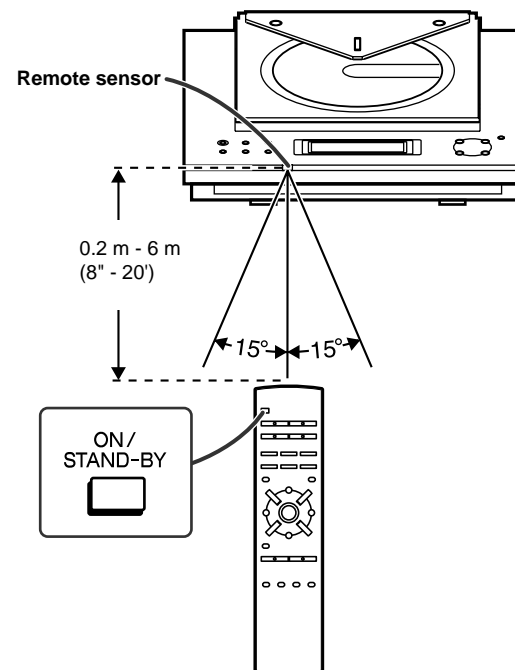

General Control

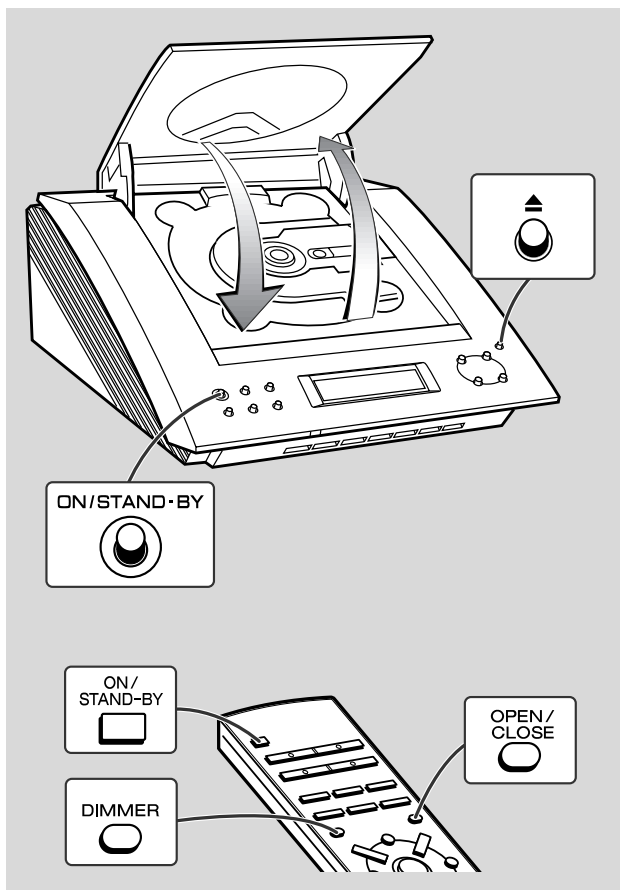

■ To turn the power on

Press the ON/STAND-BY button to turn the power on.

To set the unit to stand-by mode:

Press the ON/STAND-BY button again.

■ To change the display brightness (2 levels)

You can switch the display brightness by pressing the DIMMER button on the remote control.

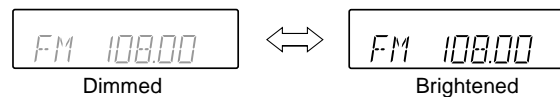

■ Opening and closing the CD compartment

The CD compartment cover is motorised.

When the power is turned on, you can open or close the CD compartment cover by pressing the ▲ (OPEN/CLOSE) button.

Caution:

- Do not open or close the CD compartment cover manually. It may cause malfunctions to the unit.
- Be careful not to jam your fingers in the CD compartment cover.

Sound Control

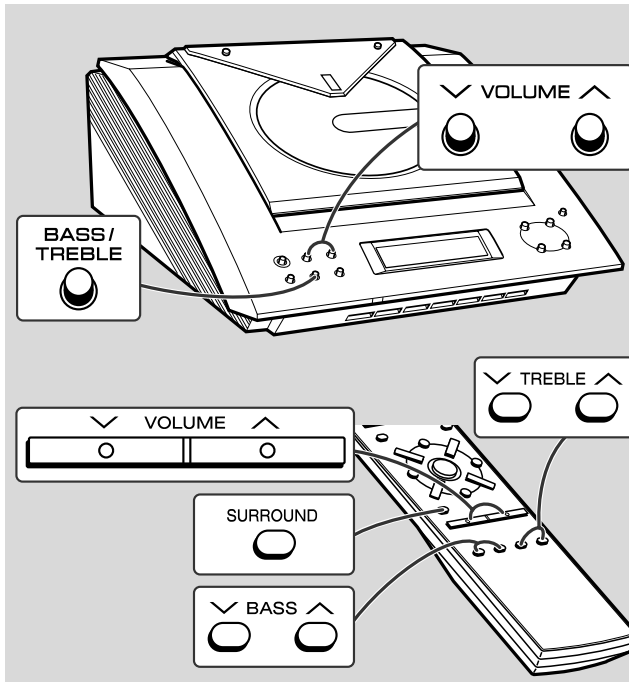

■ Adjusting the volume

Press the VOLUME ^ button to increase the volume and the VOLUME v button for decreasing.

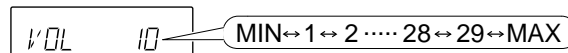

■ Adjusting the bass

Main unit operation:

- 1 Press the BASS/TREBLE button until "BASS" appears on the display.
- 2 Within 5 seconds, press the VOLUME (v or ^) button to adjust the bass.

Remote control operation:

Press the BASS (v or ^) button to adjust the bass.



■ Adjusting the treble

Main unit operation:

- 1 Press the BASS/TREBLE button until "TRE" appears on the display.
- 2 Within 5 seconds, press the VOLUME (v or ^) button to adjust the treble.

Remote control operation:

Press the TREBLE (v or ^) button to adjust the treble.



■ Setting the surround

Press the SURROUND button to allow you to enjoy music that seems to surround you. "SURROUND" will appear. To cancel the surround mode, press the SURROUND button again.

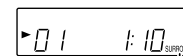

SURROUND Indicator

Note:

The surround effect cannot be obtained from monaural sound signals.

Setting the Clock

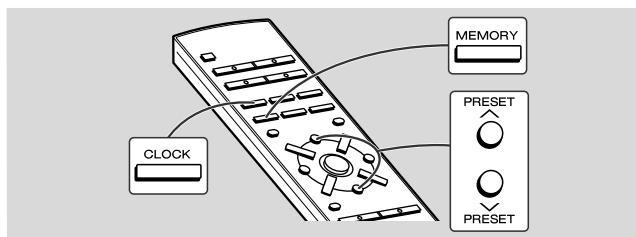

This may be operated only with the remote control.
In this example, the clock is set for the 24-hour (0:00) display.

- 1** Press the **CLOCK** button and within 3 seconds, press the **MEMORY** button.



- 2** Within 1 minute, press the **PRESET** (∨ or ∧) button to select 24-hour or 12-hour display and then press the **MEMORY** button.



"0:00" → The 24-hour display will appear.
(0:00 - 23:59)

"AM 12:00" → The 12-hour display will appear.
(AM 12:00 - PM 11:59)

Note that this can only be set when the unit is first installed or it has been reset. (Refer to step 3 under "If trouble occurs" on page 25.)

- 3** Within 1 minute, press the **PRESET** (∨ or ∧) button to adjust the hour and then press the **MEMORY** button.

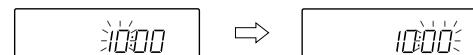

- When the 12-hour display is selected, "AM" will change automatically to "PM".

- 4** Within 1 minute, press the **PRESET** (∨ or ∧) button to adjust the minutes and then press the **MEMORY** button.

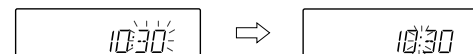

- The hour will not advance even if minutes advance from "59" to "00".
- The clock starts from "0" second. (Seconds are not displayed.)

To confirm the time display when the power is on:

Press the **CLOCK** button.
The time display will appear for about 5 seconds.

Note:

The time will flash at the push of the **CLOCK** button when the AC power supply is restored after a power failure or unplugging the unit. Readjust the clock as follows.

To readjust the clock:

Perform "Setting the Clock" from the beginning.

To change the 24-hour or 12-hour display:

- 1 Clear all the programmed contents. [Perform step 3 under "If trouble occurs" on page 25.]
- 2 Perform "Setting the Clock" from the beginning.

Listening to a CD

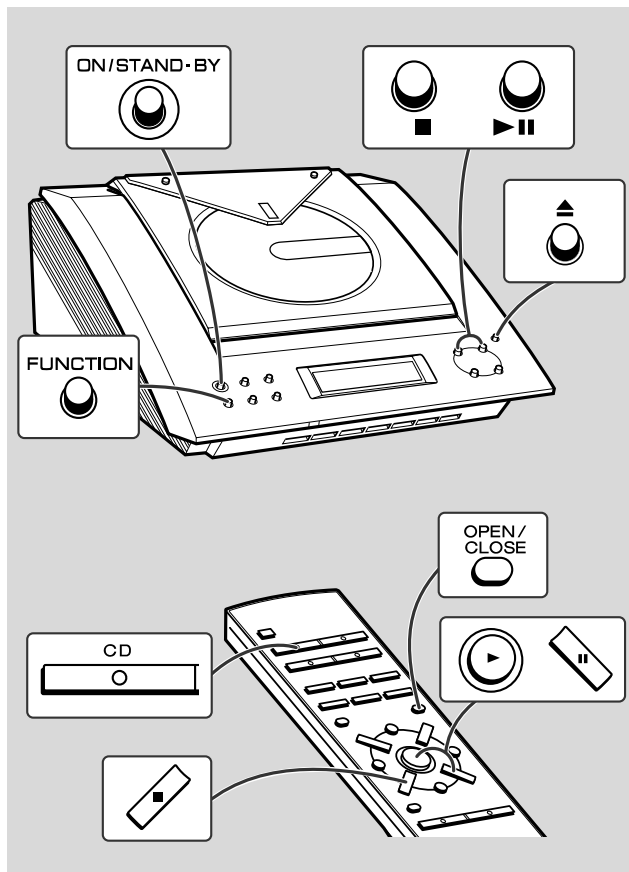

- 1** Press the **ON/STAND-BY** button to turn the power on.
- 2** Press the **FUNCTION** button until "CD STOP" or "NO DISC" appears on the display.
When operating with the remote control, press the CD button.
- 3** Press the **▲ (OPEN/CLOSE)** button to open the CD compartment.
- 4** Place a CD on the spindle, label side up.
Be sure to place 8 cm (3") disc in the middle of a disc holder.



12 cm (5")

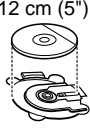

8 cm (3")

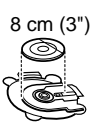
- 5** Press the **▲ (OPEN/CLOSE)** button to close the CD compartment.

16

Total number of tracks

47:30

Total playing time
- 6** Press the **▶|| (▶)** button to start playback from track 1.
When the last track on the disc has finished playing, the CD player will stop automatically.

To interrupt playback:

Main unit operation:

Press the ►|| button.

To resume playback from the same point, press the ►|| button again.

Remote control operation:

Press the || button.

To resume playback from the same point, press the ► button.

To stop playback:

Press the ■ button.

To remove the CD:

Whilst in the stop mode, press the ▲ (OPEN/CLOSE) button.

Press the CD eject button and remove the CD.

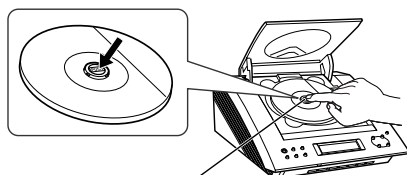

CD Eject Button

Notes:

- After removing the CD, make sure to press the ▲ (OPEN/CLOSE) button and close the CD compartment.
- When the unit enters the stand-by mode, the opened CD compartment cover will be closed automatically.

After use:

Press the ON/STAND-BY button to enter the power stand-by mode.

Caution:

- Do not open or close the CD compartment cover manually. It may cause malfunctions to the unit.
- Be careful not to jam your fingers in the CD compartment cover.
- If the power fails whilst the compartment is open, wait until the power is restored.
- If a disc is damaged, dirty, or loaded upside down, "NO DISC" or "READ ERR" will appear on the display.
- Keep foreign objects out of the CD compartment.
- Subjecting the unit to shock or vibration may cause mistracking.
- When the unit is not being used, be sure to close the CD compartment. If it is left open, the lens may be covered with dust and the unit may not operate properly.
- If TV or radio interference occurs during CD operation, move the unit away from the TV or radio.

■ Care of compact discs

Compact discs are fairly resistant to damage, however mistracking can occur due to an accumulation of dirt on the disc surface. Follow the guidelines below for maximum enjoyment from your CD collection and player.

- Do not write on either side of the disc, particularly the non-label side from which signals are read. Do not mark this surface.
- Keep your discs away from direct sunlight, heat, and excessive moisture.
- Always hold the CDs by the edges. Fingerprints, dirt, or water on the CDs can cause noise or mistracking. If a CD is dirty or does not play properly, clean it with a soft, dry cloth, wiping straight out from the centre, along the radius.

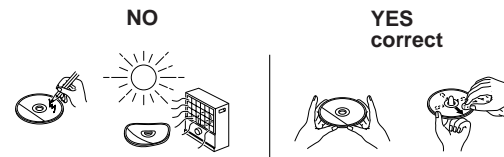

Listening to a CD (continued)

■ To locate the beginning of a track

To move to the beginning of the next track:

Press the ►► button for less than 0.5 seconds during playback.



- You can skip to any track by pressing the ►► button repeatedly until the desired track number appears.

To restart the track being played:

Press the ◀◀ button for less than 0.5 seconds during playback.



- You can skip to any track by pressing the ◀◀ button repeatedly until the desired track number appears.

■ To locate the desired portion

For audible fast forward:

Press and hold down the ►► button during playback.

For audible fast reverse:

Press and hold down the ◀◀ button during playback.

Notes:

- Normal playback will resume when the ◀◀ or ►► button is released.
- When the end of the last track is reached during fast forward, "END" will appear on the display and CD operation will be paused. When the beginning of the first track is reached during fast reverse, playback will start when you release the ◀◀ button.
- The ◀◀ or ►► button on the remote control allows you to locate the desired portion.

Repeat or Random Play

You can select one of the CD playback mode; "Repeat play", "Random play" and "Normal play".

- When in the CD mode, press the RANDOM/REPEAT button on the remote control repeatedly to select the playback mode.



Repeat playback mode Random playback mode

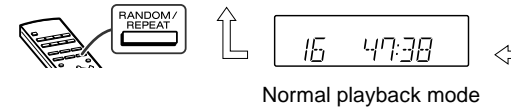

Normal playback mode

- Press the ► button to start playback.

To repeat a programmed sequence:

Perform steps 1 - 5 in the "Programmed Play" section and then select the repeat playback.

Notes:

- In random play, the CD player will select and play tracks automatically. (You cannot select the order of the tracks.)
- If you press the ►► button during random play, you can move to the track selected next by the random operation. On the other hand, the ◀◀ button does not allow you to move to the previous track. The beginning of the track being played will be located.

Caution:

After performing repeat or random play, be sure to press the ■ button. Otherwise, the disc will play continuously.

To cancel repeat or random play:

Press the RANDOM/REPEAT button on the remote control repeatedly to select the normal playback mode.

Programmed Play

You can choose up to 20 selections for playback in the order you like.

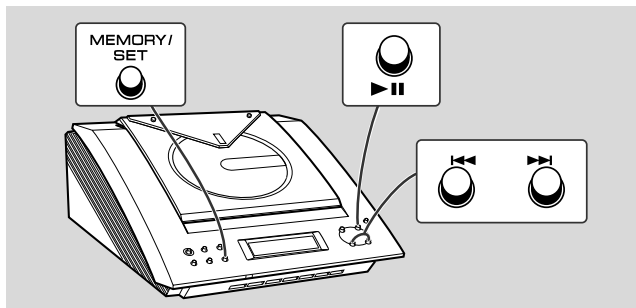

1 Whilst in the stop mode, press the **MEMORY/SET (MEMORY)** button to enter the programming save mode.



2 Within 30 seconds, press the **◀◀** or **▶▶** button to select the desired track.

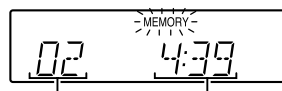

Selected track number Playback time

3 Press the **MEMORY/SET(MEMORY)** button to save the track number.

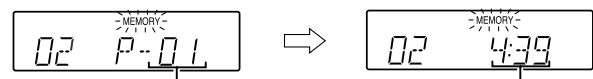

Playback order

Total playback time

4 Repeat steps 2 - 3 for other tracks. Up to 20 tracks can be programmed.

5 Press the **▶▶ (▶)** button to start playback.

To clear the programmed selections:

Press the **CLEAR** button on the remote control whilst the "MEMORY" indicator is flashing. Each time the button is pressed, one track will be cleared, beginning with the last track programmed.

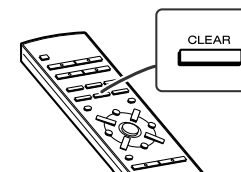

To cancel the programmed play mode:

Whilst in the stop mode and the "MEMORY" indicator is lit, press the **CLEAR** button on the remote control. The "MEMORY" indicator will disappear and all the programmed contents will be cleared.

Adding tracks to the programme:

If a programme has been previously stored, the "MEMORY" indicator will be displayed. Then follow steps 1 - 3 to add tracks. The new tracks will be stored after the last track of the original programme.

Notes:

- Opening the CD compartment automatically cancels the programmed sequence.
- Even if you press the **ON/STAND-BY** button to enter the stand-by mode or the function is changed from CD to some other function, the programmed selections will not be cleared.
- During programme operation, random play is not possible.

Listening to the Radio

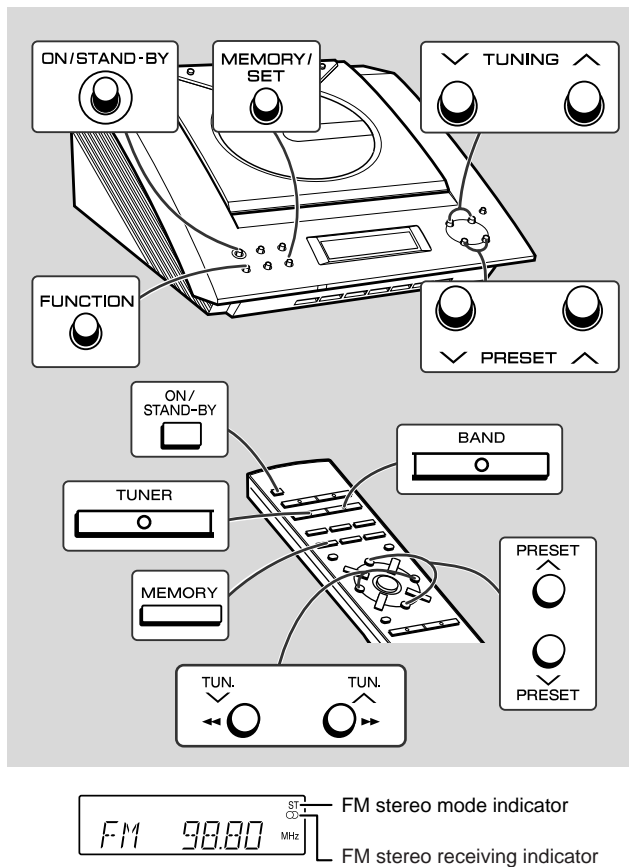

1 Press the ON/STAND-BY button to turn the power on.

2 Press the FUNCTION button until "FM" or "AM" appears on the display.

When operating with the remote control, press the TUNER button, and then the BAND button to select "FM" or "AM".

3 Press the TUNING (∨ or ∧) button to tune in to the desired station.

Manual tuning:

Press the TUNING button as many times as required to tune in to the desired station.

Auto tuning:

When the TUNING button is pressed for more than 0.5 seconds, scanning will start automatically and the tuner will stop at the first receivable broadcast station.

Notes:

- This can be operated by pressing the TUN. (∨ or ∧) button on the remote control.
- When radio interference occurs, auto scan tuning may stop automatically at that point.
- Auto scan tuning will skip weak signal stations.
- To stop the auto tuning, press the TUNING button again.

To receive an FM stereo transmission:

Press the FUNCTION (BAND) button to display the "ST" indicator.

- "∞" will appear when an FM broadcast is in stereo.
- If the FM reception is weak, press the FUNCTION (BAND) button to extinguish the "ST" indicator. The reception changes to monaural, and the sound becomes clearer.

After use:

Press the ON/STAND-BY button to enter the power stand-by mode.



Note:

This product can receive FM stereo/FM monaural and AM monaural broadcasts. AM stereo broadcasts will not be played in stereo.

Listening to the Memorised Station

■ Memorising a station

You can store 30 AM and FM stations in memory and recall them at the push of a button. (Preset tuning)

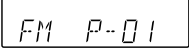
- 1 Perform the steps 1 - 3 in "Listening to the Radio" on page 19.**
- 2 Press the MEMORY/SET (MEMORY) button to enter the preset tuning saving mode.**

- 3 Within 5 seconds, press the PRESET (∨ or ∧) button to select the preset channel number.**
Store the stations in memory, in order, starting with preset channel 1.

- 4 Within 5 seconds, press the MEMORY/SET (MEMORY) button to store that station in memory.**
If the "MEMORY" and preset number indicators go out before the station is memorised, repeat the operation from step 2.

- 5 Repeat steps 1 - 4 to set other stations, or to change a preset station.**
When a new station is stored in memory, the station previously memorised will be erased.

Note:

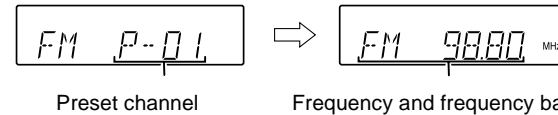
The backup function protects the memorised stations for a few hours should there be a power failure or the AC power lead disconnection.

■ To recall a memorised station

Press the PRESET (∨ or ∧) button for less than 0.5 seconds to select the desired station.



■ To scan the preset stations

The stations saved in memory can be scanned automatically. (Preset memory scan)

- 1 Press the PRESET (∨ or ∧) button for more than 0.5 seconds.**
The preset number will flash and the programmed stations will be tuned in sequentially, for 5 seconds each.
- 2 Press the PRESET (∨ or ∧) button again when the desired station is located.**

■ To clear a memorised station

- 1 Recall the memorised station.
- 2 Whilst it is displayed, press the MEMORY/SET (MEMORY) button.
- 3 Within 5 seconds, press the CLEAR button on the remote control.

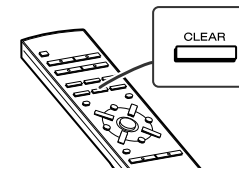

Timer and Sleep Operation

This may be operated only with the remote control.

Timer playback:

The unit turns on and plays the desired source (CD, tuner) at the preset time.

Sleep operation:

The radio and compact disc can all be turned off automatically.

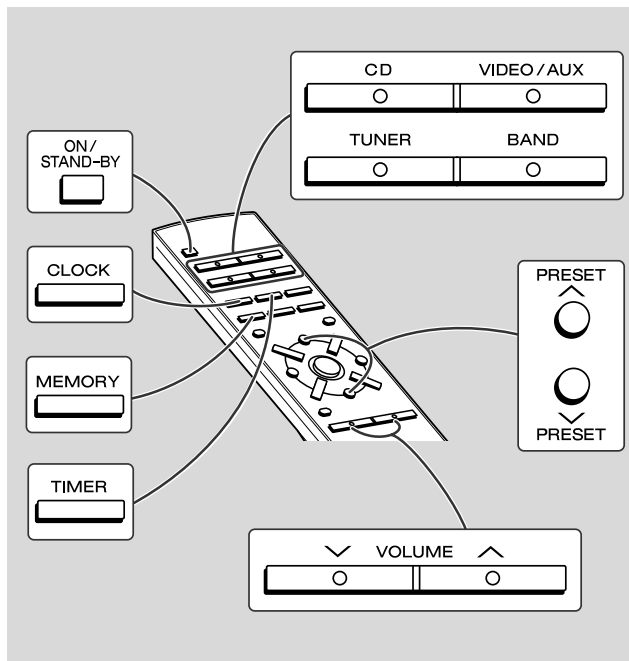

■ Timer playback

Before setting timer:

- 1 Press the CLOCK button to check that the clock is on time.



- 2 Load a disc to be played.



- 1 Press the ON/STAND-BY button to turn the power on.

- 2 Press the CD or TUNER button to select the desired function.

When you selected the TUNER, tune in to the desired station.

- 3 Adjust the volume using the VOLUME buttons.

Do not turn the volume up too high.

- 4 Press the TIMER button and within 6 seconds, press the MEMORY button.

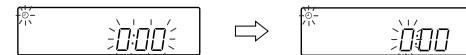

- 5 Within 1 minute, press the PRESET (∨ or ∧) button to specify the hour to start, then press the MEMORY button.

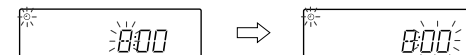

6 Within 1 minute, press the PRESET (∨ or ∧) button to specify the minutes to start, then press the MEMORY button.

- The timer playback starting time, function, and volume will be displayed, and then the unit will enter the stand-by mode automatically.
- "Ⓢ" will appear and the current time will be displayed.



To cancel the timer playback:

Press the ON/STAND-BY button to turn the power on.

7 When the preset time is reached, playback will start.

The volume will increase gradually until it reaches the volume you were listening at before your system enters the timer stand-by mode.

8 If you select CD, the unit will enter the stand-by mode after the playback. If you select TUNER, it will enter the stand-by mode one hour after the timer playback starts.

To reset or change the timer setting:

Perform "Timer playback" from the beginning.

Notes:

- Once the time is set, the setting will be retained until a new time is entered.
- When performing timer playback using another unit connected to the VIDEO/AUX IN sockets, select "VIDEO/AUX" in step 2. At this time, only this unit will be turned on or enter the power stand-by mode automatically. It will enter the power stand-by mode 1 hour after the timer playback starts. (Another unit will not be turned on or off.)

Timer and Sleep Operation (continued)

■ Sleep operation

1 Play back the desired sound source.

2 Press the SLEEP button.

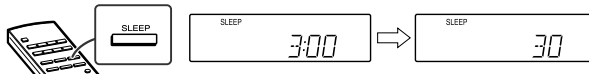

To change the sleep time:

Press the SLEEP button repeatedly to select the desired sleep time. The time will decrease as follows.

The amount of sleep time can also be changed whilst in the sleep mode.

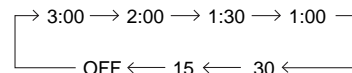

3 Your system will enter the power stand-by mode automatically after the preset time has elapsed.

The volume will be turned down 1 minute before the sleep operation finishes.

To cancel the sleep operation:

Press the ON/STAND-BY button whilst the sleep timer is set.

To confirm the remaining sleep time:

Press the SLEEP button once whilst the sleep timer is set. The remaining sleep time is displayed for about 3 seconds.

■ To use timer and sleep operation together

Example: To fall asleep and wake to the same radio station
You can play back the same source only (the function cannot be switched).

1 Set the sleep time (see left, steps 1 - 2).

2 Whilst the sleep timer is set, set the desired playback time (steps 4 - 6, pages 21 - 22).

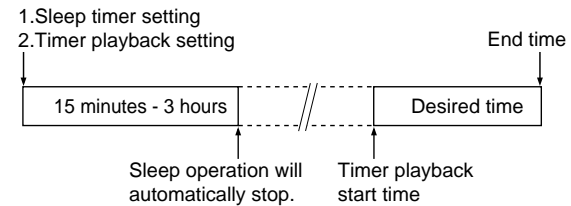

Enhancing Your System

The connection lead is not included. Purchase a commercially available lead as shown below.

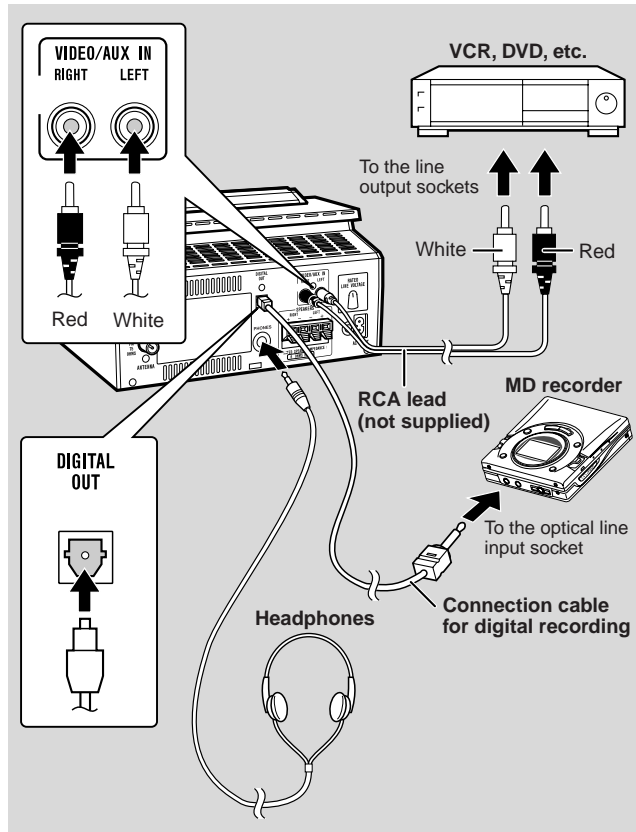

■ Listening to the playback sounds from VCR, DVD, etc.

- 1 Use a connection lead to connect the VCR, DVD, etc. to the VIDEO/AUX IN sockets.
When using video equipment, connect the audio output to this unit and the video output to a television.
- 2 Press the ON/STAND-BY button to turn the power on.
- 3 Press the FUNCTION button until "AUX" appears on the display.
When operating with the remote control, press the VIDEO/AUX button.
- 4 Play the VCR, DVD, etc.

Note:

To prevent hum interference, place this unit away from a television.

■ To record CD signals on MDs

The digital signal from this unit can be recorded by MiniDisc recorders, etc.

- 1 Remove the DIGITAL OUT socket cover.
- 2 Use a connection cable for digital recording to connect the unit to the OPTICAL IN socket of a MiniDisc recorder, etc.
- 3 Press the ON/STAND-BY button to turn the power on.
- 4 Put the MiniDisc recorder, etc. in the recording mode.
- 5 Play a CD on this unit.

Note:

Only CD signals can be output.

■ Headphones

- Before plugging in or unplugging the headphones, reduce the volume.
- Be sure your headphones have a 3.5 mm (1/8") diameter plug and are between 16 ohms and 50 ohms impedance. The recommended impedance is 32 ohms.
- Plugging in the headphones disconnects the speakers automatically. Adjust the volume using the VOLUME buttons.

Troubleshooting

■ If trouble occurs

When this product is subjected to strong external interference (mechanical shock, excessive static electricity, abnormal supply voltage due to lightning, etc.) or if it is operated incorrectly, it may malfunction.

If such a problem occurs, do the following:

- 1 **Set the unit to the stand-by mode and turn the power on again.**
- 2 **If the unit is not restored in step 1, unplug and plug in the unit, and then turn the power on.**
- 3 **If neither step 1 nor 2 restores the unit, do the following:**
 - ① Press the ON/STAND-BY button to enter the power stand-by mode.
 - ② Unplug the AC power lead from the AC INPUT socket on the unit.
 - ③ Whilst pressing down the MEMORY/SET button and the ►|| button, plug the AC power lead into the AC INPUT socket on the unit.

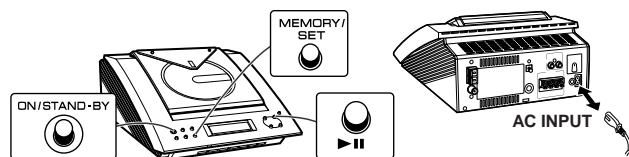

Caution:

- This operation will erase all data stored in memory including clock, timer settings, tuner preset, and CD programme.
- After the above operation, interval span setting for AM will be returned to 9 kHz (50 kHz for FM) automatically.

Maintenance

■ Cleaning the CD pickup lens

Do not touch the laser pickup lens. If fingerprints or dust accumulate on the pickup, clean it gently with a dry cotton swab.



■ Cleaning the cabinet

Periodically wipe the cabinet with a soft cloth and a diluted soap solution, then with a dry cloth.



Caution:

- Do not use chemicals for cleaning (petrol, paint thinner, etc.). It may damage the cabinet finish.
- Do not apply oil to the inside of the unit. It may cause malfunctions.

Specifications

As part of our policy of continuous improvement, SHARP reserves the right to make design and specification changes for product improvement without prior notice. The performance specification figures indicated are nominal values of production units. There may be some deviations from these values in individual units.

■ General

Power source	AC 110, 127, 220, 230 - 240 V, 50/60 Hz
Power consumption	48 W
Dimensions	Width: 230 mm (9-1/16") Height: 128 mm (5-1/16") Depth: 293 mm (11-9/16")
Weight	3.2 kg (7.1 lbs.)

■ Amplifier

Output power	MPO: 60 W (30 W + 30 W) (10 % T.H.D.) RMS: 40 W (20 W + 20 W) (10 % T.H.D.)
Output terminals	Speakers: 6 ohms Headphones: 16 - 50 ohms (recommended: 32 ohms) CD digital output (optical)
Input terminals	Video/Auxiliary (audio signal): 500 mV/47 kohms

■ CD player

Type	Compact disc player
Signal readout	Non-contact, 3-beam semiconductor laser pickup
D/A converter	1-bit D/A converter
Frequency response	20 - 20,000 Hz
Dynamic range	90 dB (1 kHz)

■ Tuner

Frequency range	FM: 88 - 108 MHz AM: 531 - 1,602 kHz
------------------------	---

■ Speaker

Type	2-way type speaker system 5 cm (2") Tweeter 10 cm (4") Woofer
Maximum input power	40 W
Rated input power	20 W
Impedance	6 ohms
Dimensions	Width: 140 mm (5-9/16") Height: 288 mm (11-3/8") Depth: 187 mm (7-3/8")
Weight	2.0 kg (4.4 lbs.)/each



SHARP
SHARP CORPORATION

TINSE0074SJZZ

B0103.HK

