

ONKYO®

AV Receiver

TX-SR309

Instruction Manual

Thank you for purchasing an Onkyo AV Receiver. Please read this manual thoroughly before making connections and plugging in the unit. Following the instructions in this manual will enable you to obtain optimum performance and listening enjoyment from your new AV Receiver. Please retain this manual for future reference.

Contents

Introduction2

Connections.....10

Turning On & Basic Operations 17

Advanced Operations29

Controlling Other Components 38

Appendix43



WARNING:

TO REDUCE THE RISK OF FIRE OR ELECTRIC SHOCK, DO NOT EXPOSE THIS APPARATUS TO RAIN OR MOISTURE.

CAUTION:

TO REDUCE THE RISK OF ELECTRIC SHOCK, DO NOT REMOVE COVER (OR BACK). NO USER-SERVICEABLE PARTS INSIDE. REFER SERVICING TO QUALIFIED SERVICE PERSONNEL.



WARNING
RISK OF ELECTRIC SHOCK
DO NOT OPEN

AVIS
RISQUE DE CHOC ELECTRIQUE
NE PAS OUVRIR



The lightning flash with arrowhead symbol, within an equilateral triangle, is intended to alert the user to the presence of uninsulated "dangerous voltage" within the product's enclosure that may be of sufficient magnitude to constitute a risk of electric shock to persons.



The exclamation point within an equilateral triangle is intended to alert the user to the presence of important operating and maintenance (servicing) instructions in the literature accompanying the appliance.

Important Safety Instructions

1. Read these instructions.
2. Keep these instructions.
3. Heed all warnings.
4. Follow all instructions.
5. Do not use this apparatus near water.
6. Clean only with dry cloth.
7. Do not block any ventilation openings. Install in accordance with the manufacturer's instructions.
8. Do not install near any heat sources such as radiators, heat registers, stoves, or other apparatus (including amplifiers) that produce heat.
9. Do not defeat the safety purpose of the polarized or grounding-type plug. A polarized plug has two blades with one wider than the other. A grounding type plug has two blades and a third grounding prong. The wide blade or the third prong are provided for your safety. If the provided plug does not fit into your outlet, consult an electrician for replacement of the obsolete outlet.
10. Protect the power cord from being walked on or pinched particularly at plugs, convenience receptacles, and the point where they exit from the apparatus.
11. Only use attachments/accessories specified by the manufacturer.
12. Use only with the cart, stand, tripod, bracket, or table specified by the manufacturer, or sold with the apparatus. When a cart is used, use caution when moving the cart/apparatus combination to avoid injury from tip-over.

PORTABLE CART WARNING
S3125A
13. Unplug this apparatus during lightning storms or when unused for long periods of time.
14. Refer all servicing to qualified service personnel. Servicing is required when the apparatus has been damaged in any way, such as power-supply cord or plug is damaged, liquid has been spilled or objects have fallen into the apparatus, the apparatus has been exposed to rain or moisture, does not operate normally, or has been dropped.
15. Damage Requiring Service
Unplug the apparatus from the wall outlet and refer servicing to qualified service personnel under the following conditions:
 - A. When the power-supply cord or plug is damaged,
 - B. If liquid has been spilled, or objects have fallen into the apparatus,
 - C. If the apparatus has been exposed to rain or water,
 - D. If the apparatus does not operate normally by following the operating instructions. Adjust only those controls that are covered by the operating instructions as an improper adjustment of other controls may result in damage and will often require extensive work by a qualified technician to restore the apparatus to its normal operation,
 - E. If the apparatus has been dropped or damaged in any way, and
 - F. When the apparatus exhibits a distinct change in performance this indicates a need for service.
16. Object and Liquid Entry
Never push objects of any kind into the apparatus through openings as they may touch dangerous voltage points or short-out parts that could result in a fire or electric shock.
The apparatus shall not be exposed to dripping or splashing and no objects filled with liquids, such as vases shall be placed on the apparatus.
Don't put candles or other burning objects on top of this unit.
17. Batteries
Always consider the environmental issues and follow local regulations when disposing of batteries.
18. If you install the apparatus in a built-in installation, such as a bookcase or rack, ensure that there is adequate ventilation.
Leave 20 cm (8") of free space at the top and sides and 10 cm (4") at the rear. The rear edge of the shelf or board above the apparatus shall be set 10 cm (4") away from the rear panel or wall, creating a flue-like gap for warm air to escape.
The temperature protection operates if the apparatus attain an abnormal high temperature.
The apparatus cannot operate until it has cooled down.

Precautions

1. **Recording Copyright**—Unless it's for personal use only, recording copyrighted material is illegal without the permission of the copyright holder.
2. **AC Fuse**—The AC fuse inside the unit is not user-serviceable. If you cannot turn on the unit, contact your Onkyo dealer.
3. **Care**—Occasionally you should dust the unit all over with a soft cloth. For stubborn stains, use a soft cloth dampened with a weak solution of mild detergent and water. Dry the unit immediately afterwards with a clean cloth. Don't use abrasive cloths, thinners, alcohol, or other chemical solvents, because they may damage the finish or remove the panel lettering.

4. Power

WARNING

BEFORE PLUGGING IN THE UNIT FOR THE FIRST TIME, READ THE FOLLOWING SECTION CAREFULLY.

AC outlet voltages vary from country to country. Make sure that the voltage in your area meets the voltage requirements printed on the unit's rear panel (e.g., AC 230 V, 50 Hz or AC 120 V, 60 Hz).

The power cord plug is used to disconnect this unit from the AC power source. Make sure that the plug is readily operable (easily accessible) at all times.

Pressing the [ON/STANDBY] button to select Standby mode does not fully disconnect from the mains. If you do not intend to use the unit for an extended period, remove the power cord from the AC outlet.

5. Preventing Hearing Loss

Caution

Excessive sound pressure from earphones and headphones can cause hearing loss.

6. Batteries and Heat Exposure

Warning

Batteries (battery pack or batteries installed) shall not be exposed to excessive heat as sunshine, fire or the like.

7. Never Touch this Unit with Wet Hands

—Never handle this unit or its power cord while your hands are wet or damp. If water or any other liquid gets inside this unit, have it checked by your Onkyo dealer.

8. Handling Notes

- If you need to transport this unit, use the original packaging to pack it how it was when you originally bought it.
- Do not leave rubber or plastic items on this unit for a long time, because they may leave marks on the case.
- This unit's top and rear panels may get warm after prolonged use. This is normal.
- If you do not use this unit for a long time, it may not work properly the next time you turn it on, so be sure to use it occasionally.

For U.S. models

FCC Information for User

CAUTION:

The user changes or modifications not expressly approved by the party responsible for compliance could void the user's authority to operate the equipment.

NOTE:

This equipment has been tested and found to comply with the limits for a Class B digital device, pursuant to Part 15 of the FCC Rules. These limits are designed to provide reasonable protection against harmful interference in a residential installation.

This equipment generates, uses and can radiate radio frequency energy and, if not installed and used in accordance with the instructions, may cause harmful interference to radio communications. However, there is no guarantee that interference will not occur in a particular installation. If this equipment does cause harmful interference to radio or television reception, which can be determined by turning the equipment off and on, the user is encouraged to try to correct the interference by one or more of the following measures:

- Reorient or relocate the receiving antenna.
- Increase the separation between the equipment and receiver.
- Connect the equipment into an outlet on a circuit different from that to which the receiver is connected.
- Consult the dealer or an experienced radio/TV technician for help.

For Canadian Models

NOTE: THIS CLASS B DIGITAL APPARATUS COMPLIES WITH CANADIAN ICES-003.

For models having a power cord with a polarized plug:

CAUTION: TO PREVENT ELECTRIC SHOCK, MATCH WIDE BLADE OF PLUG TO WIDE SLOT, FULLY INSERT.

Modèle pour les Canadien

REMARQUE: CET APPAREIL NUMÉRIQUE DE LA CLASSE B EST CONFORME À LA NORME NMB-003 DU CANADA.

Sur les modèles dont la fiche est polarisée:

ATTENTION: POUR ÉVITER LES CHOCS ÉLECTRIQUES, INTRODUIRE LA LAME LA PLUS LARGE DE LA FICHE DANS LA BORNE CORRESPONDANTE DE LA PRISE ET POUSSER JUSQU'AU FOND.

For British models

Replacement and mounting of an AC plug on the power supply cord of this unit should be performed only by qualified service personnel.

IMPORTANT

The wires in the mains lead are coloured in accordance with the following code:

Blue: Neutral

Brown: Live

As the colours of the wires in the mains lead of this apparatus may not correspond with the coloured markings identifying the terminals in your plug, proceed as follows:

The wire which is coloured blue must be connected to the terminal which is marked with the letter N or coloured black.

The wire which is coloured brown must be connected to the terminal which is marked with the letter L or coloured red.

IMPORTANT

The plug is fitted with an appropriate fuse. If the fuse needs to be replaced, the replacement fuse must be approved by ASTA or BSI to BS1362 and have the same ampere rating as that indicated on the plug. Check for the ASTA mark or the BSI mark on the body of the fuse.

If the power cord's plug is not suitable for your socket outlets, cut it off and fit a suitable plug. Fit a suitable fuse in the plug.

For European Models

Declaration of Conformity	
We, ONKYO EUROPE ELECTRONICS GmbH LIEGNITZERSTRASSE 6, 82194 GROEBENZELL, GERMANY	
declare in own responsibility, that the ONKYO product described in this instruction manual is in compliance with the corresponding technical standards such as EN60065, EN55013, EN55020 and EN61000-3-2, -3-3.	
GROEBENZELL, GERMANY	 K. MIYAGI
ONKYO EUROPE ELECTRONICS GmbH	

Supplied Accessories

Make sure you have the following accessories:

Indoor FM antenna (→ page 16)

AM loop antenna (→ page 16)

Power cord (Taiwan models) (→ page 16)

Speaker cable labels (→ page 11)

Remote controller (RC-799M) and two batteries (AA/R6) (→ page 4)

(Note for China: The battery for the remote controller is not supplied for this unit.)

* In catalogs and on packaging, the letter at the end of the product name indicates the color. Specifications and operations are the same regardless of color.

■ Installing the batteries

Note

- If the remote controller doesn't work reliably, try replacing the batteries.
- Don't mix new and old batteries or different types of batteries.
- If you intend not to use the remote controller for a long time, remove the batteries to prevent damage from leakage or corrosion.
- Remove expired batteries as soon as possible to prevent damage from leakage or corrosion.

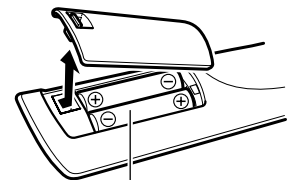

Batteries (AA/R6)

■ Aiming the remote controller

To use the remote controller, point it at the AV receiver's remote control sensor, as shown below.

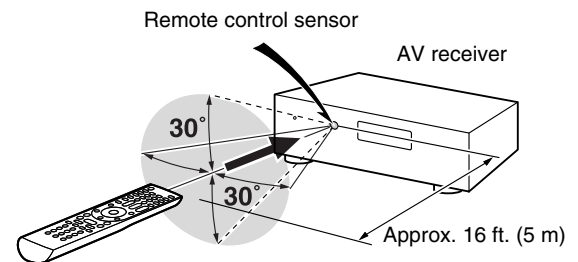

Contents

Introduction

Important Safety Instructions	2
Precautions.....	3
Supplied Accessories.....	4
Features	6
Front & Rear Panels.....	7
Front Panel.....	7
Display.....	8
Rear Panel	8
Remote Controller	9
Controlling the AV Receiver	9

Connections

Connecting the AV Receiver.....	10
Connecting Your Speakers	10
About AV Connections	12
Connecting Components with HDMI	13
Connecting Your Components	14
Connecting Onkyo RI Components	15
Connecting a Recording Component	15
Connecting Antenna.....	16
Connecting the Power Cord	16

Turning On & Basic Operations

Turning On/Off the AV Receiver	17
Turning On	17
Turning Off	17
Playback.....	18
Playing the Connected Component.....	18
Controlling Contents of USB Devices.....	18
Understanding Icons on the Display.....	19
Playing iPod/iPhone via USB	19
Playing USB Device	20
Listening to AM/FM Radio	20
Using Basic Functions	23
Using the Listening Modes	23
Using the Home Menu.....	26
Selecting Speakers A and B.....	26
Using the Sleep Timer.....	26
Setting the Display Brightness	27
Displaying Source Information	27
Changing the Input Display	27
Using the Music Optimizer	27
Muting the AV Receiver.....	28
Using Headphones.....	28
Recording	28

Advanced Operations

Advanced Setup	29
On-screen Setup Menus	29
Common Procedures in Setup Menu	29
HDMI Input	30
Component (Component Video Input).....	30
Digital Audio (Digital Audio Input).....	30
Sp Config (Speaker Configuration)	31
Sp Distance (Speaker Distance)	31
Level Cal (Level Calibration)	32
Audio Adjust	32
Source Setup.....	33
Hardware.....	34
HDMI Setup.....	35
Using the Audio Settings	36

Controlling Other Components

iPod/iPhone Playback via Onkyo Dock	38
Using the Onkyo Dock.....	38
Controlling Your iPod/iPhone	38
Controlling Other Onkyo Components	40
Preprogrammed Remote Control Codes	40
Entering Remote Control Codes.....	40
Remote Control Codes for Onkyo Components	
Connected via RI	40
Resetting REMOTE MODE Buttons	41
Resetting the Remote Controller	41
Controlling Other Components	41

Appendix

Troubleshooting	43
Connection Tips and Video Signal Path	47
USB Features	48
About HDMI.....	49
Using an RIHD-compatible TV, Player,	
or Recorder.....	50
Specifications	52

To reset the AV receiver to its factory defaults, turn it on and, while holding down VCR/DVR, press  ON/STANDBY (→ page 43).

Features

Amplifier

- 65 Watts/Channel @ 8 ohms (FTC)
- 100 Watts/Channel @ 6 ohms (IEC)
- 120 Watts/Channel @ 6 ohms (JEITA)
- Optimum Gain Volume Circuitry
- H.C.P.S. (High Current Power Supply) Massive High Power Transformer

Processing

- HDMI (Audio Return Channel, 3D, DeepColor, x.v.Color*¹, Lip Sync, DTS*²-HD Master Audio, DTS-HD High Resolution Audio, Dolby TrueHD*³, Dolby Digital Plus, DSD and Multi-CH PCM)
- Non-Scaling Configuration
- A-Form Listening Mode Memory
- Direct Mode
- Music Optimizer*⁴ for Compressed Digital Music files
- 192 kHz/24-bit D/A Converters
- Powerful and Highly Accurate 32-bit Processing DSP

Connections

- 3 HDMI*⁵ Inputs and 1 Output
- Onkyo **RIHD** for System Control
- 3 Digital Inputs (2 Optical/1 Coaxial)
- Component Video Switching (2 Inputs/1 Output)
- Front-Panel USB Input for Memory Devices and iPod®/iPhone® models*⁶

Miscellaneous

- 40 FM/AM Presets
- Crossover Adjustment (40/50/60/70/80/90/100/120/150/200 Hz)
- A/V Sync Control Function (up to 400 ms)
- Auto Standby Function
- On-Screen Display via HDMI

*1 “x.v.Color” is a trademark of Sony Corporation.

*2 

Manufactured under license under U.S. Patent #'s: 5,451,942; 5,956,674; 5,974,380; 5,978,762; 6,226,616; 6,487,535; 7,212,872; 7,333,929; 7,392,195; 7,272,567 & other U.S. and worldwide patents issued & pending. DTS and the Symbol are registered trademarks, & DTS-HD, DTS-HD Master Audio, and the DTS logos are trademarks of DTS, Inc. Product includes software.

© DTS, Inc. All Rights Reserved.

*3 

Manufactured under license from Dolby Laboratories. Dolby, Pro Logic and the double-D symbol are trademarks of Dolby Laboratories.

*4 Music Optimizer™ is a trademark of Onkyo Corporation.

*5 

“HDMI, the HDMI Logo, and High-Definition Multimedia Interface are trademarks or registered trademarks of HDMI Licensing LLC in the United States and other countries.”

*6



iPhone, iPod, iPod classic, iPod nano, iPod shuffle, and iPod touch are trademarks of Apple Inc., registered in the U.S. and other countries.

“Made for iPod” and “Made for iPhone” mean that an electronic accessory has been designed to connect specifically to iPod or iPhone, respectively, and has been certified by the developer to meet Apple performance standards. Apple is not responsible for the operation of this device or its compliance with safety and regulatory standards.

Please note that the use of this accessory with iPod or iPhone may affect wireless performance.

Front & Rear Panels

Front Panel

(North American and Taiwan models)

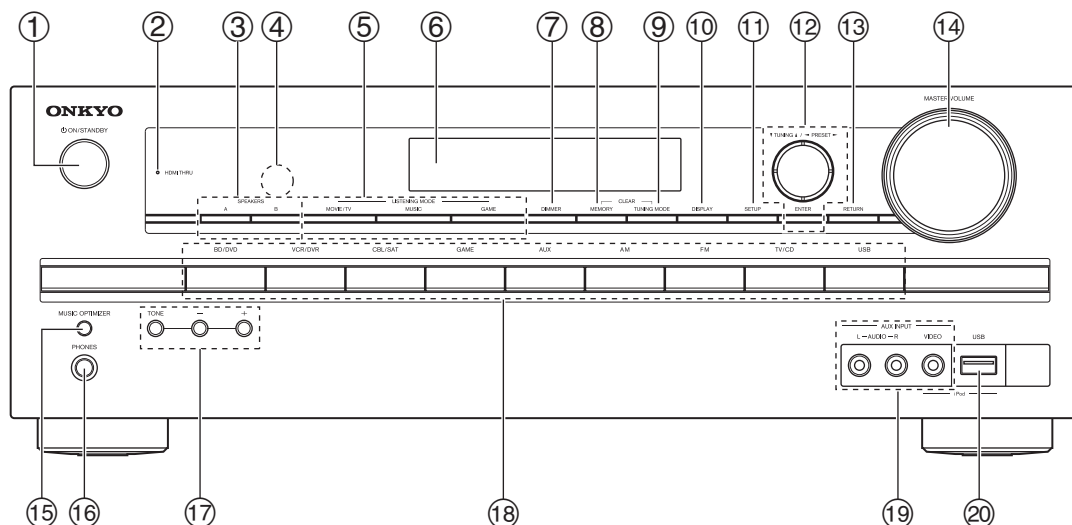

(European, Australian and Asian models)

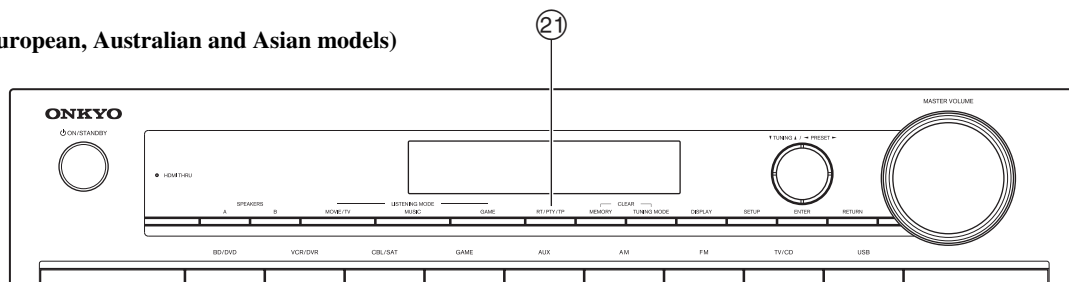

The page numbers in parentheses show where you can find the main explanation for each item.

- | | |
|--|--|
| ① ON/STANDBY button (17) | ⑫ TUNING, PRESET (20 to 21), arrow and ENTER buttons |
| ② HDMI THRU indicator (35) | ⑬ RETURN button |
| ③ SPEAKERS A and B buttons (26) | ⑭ MASTER VOLUME control (18) |
| ④ Remote control sensor (4) | ⑮ MUSIC OPTIMIZER button (27, 37) |
| ⑤ LISTENING MODE buttons (23) | ⑯ PHONES jack (28) |
| ⑥ Display (8) | ⑰ TONE and Tone Level buttons (36) |
| ⑦ DIMMER button (North American and Taiwan models) (27) | ⑱ INPUT selector buttons (18) |
| ⑧ MEMORY button (21) | ⑲ AUX INPUT AUDIO and VIDEO jacks (14, 28) |
| ⑨ TUNING MODE button (20) | ⑳ USB port (14) |
| ⑩ DISPLAY button (27) | ㉑ RT/PTY/TP button (European, Australian and Asian models) (22) |
| ⑪ SETUP button (29) | |

Display

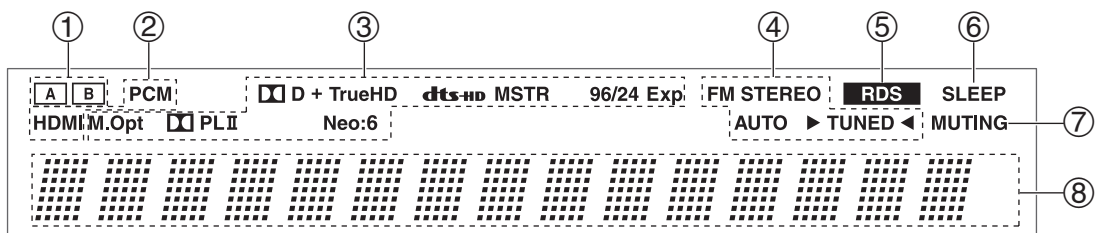

For detailed information, see the pages in parentheses.

- ① A and B speaker indicators (26)
- ② Audio input indicators
- ③ Listening mode and format indicators (23, 27)
- ④ Tuning indicators (20)
- ⑤ RDS indicator (excluding North American models) (21)
- ⑥ SLEEP indicator (26)
- ⑦ MUTING indicator (28)
- ⑧ Message area

Rear Panel

(North American, European, Australian and Asian models)

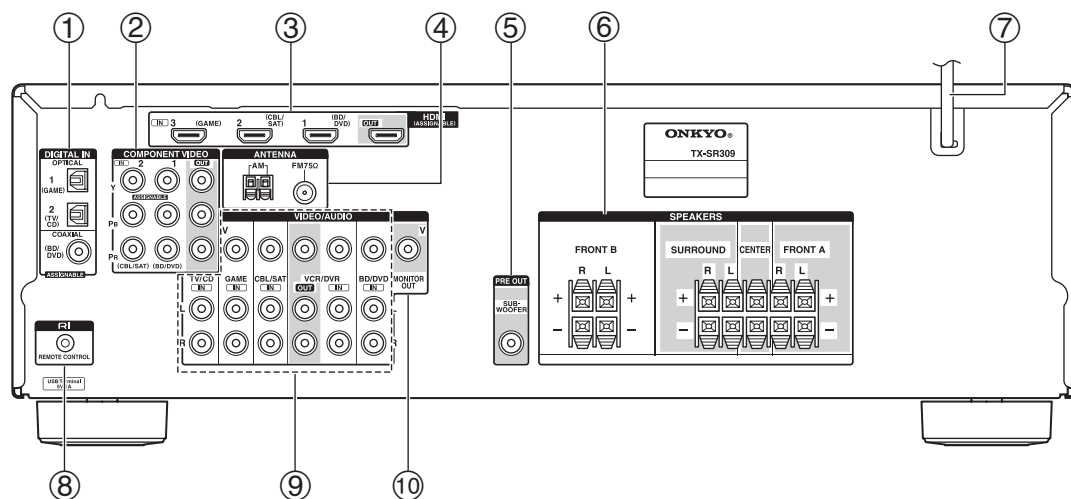

(Taiwan models)

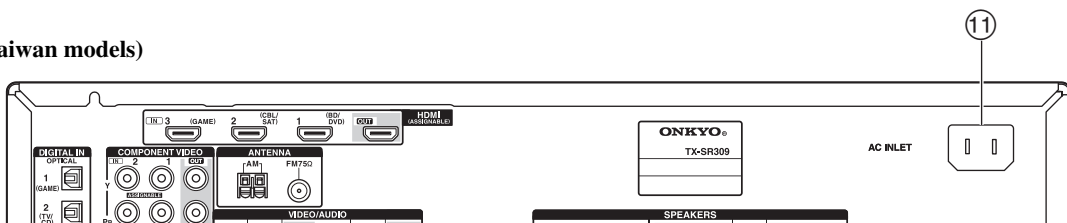

- ① DIGITAL IN COAXIAL and OPTICAL jacks
- ② COMPONENT VIDEO IN and OUT jacks
- ③ HDMI IN and OUT jacks
- ④ FM ANTENNA jack and AM ANTENNA terminal
- ⑤ SUBWOOFER PRE OUT jack
- ⑥ SPEAKERS terminals (FRONT A, CENTER, SURROUND, FRONT B)
- ⑦ Power cord (North American, European, Australian and Asian models)
- ⑧ RI REMOTE CONTROL jack
- ⑨ Composite video and analog audio jacks (BD/DVD IN, VCR/DVR IN and OUT, CBL/SAT IN, GAME IN, TV/CD IN)
- ⑩ MONITOR OUT V jack
- ⑪ AC INLET (Taiwan models)

See "Connecting the AV Receiver" for connection (→ pages 10 to 16).

Remote Controller

Controlling the AV Receiver

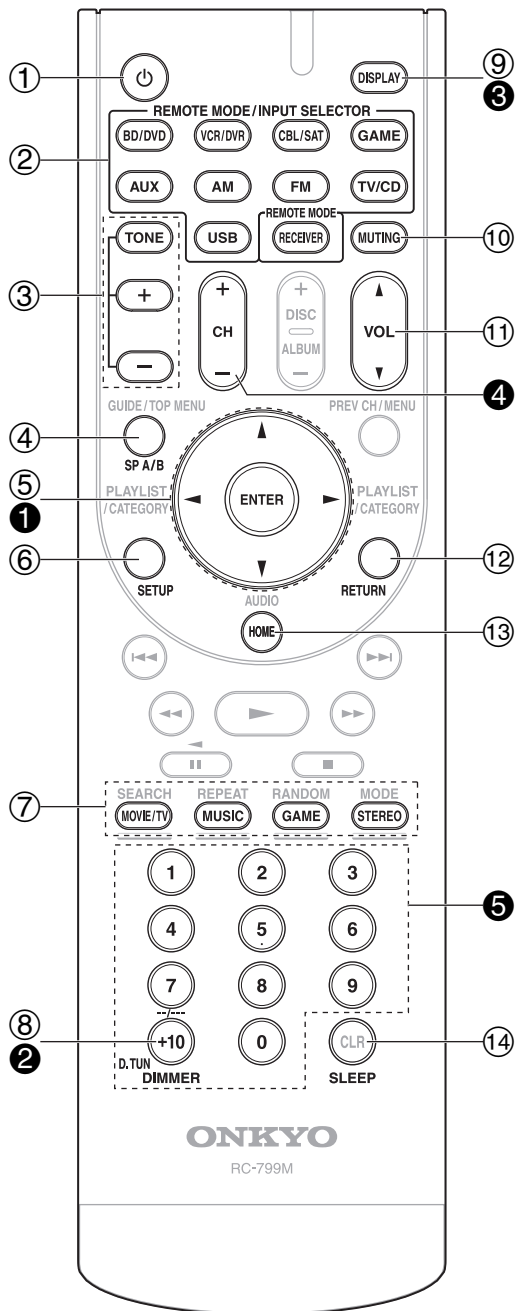

To control the AV receiver, press **RECEIVER** to select Receiver mode.

You can also use the remote controller to control Onkyo Blu-ray Disc/DVD player, CD player, and other components.

See “Entering Remote Control Codes” for more details (→ page 40).

For detailed information, see the pages in parentheses.

- ① **Power button (17)**
- ② **REMOTE MODE/INPUT SELECTOR buttons (18, 40 to 41)**
- ③ **TONE and Tone Level buttons (36)**
- ④ **SP A/B button (26)**
- ⑤ **Arrow $\blacktriangle/\blacktriangledown/\blacktriangleleft/\blacktriangleright$ and ENTER buttons**
- ⑥ **SETUP button (29)**
- ⑦ **LISTENING MODE buttons (23)**
- ⑧ **DIMMER button (27)**
- ⑨ **DISPLAY button (27)**
- ⑩ **MUTING button (28)**
- ⑪ **VOL $\blacktriangle/\blacktriangledown$ button (18)**
- ⑫ **RETURN button**
- ⑬ **HOME button (26)**
- ⑭ **SLEEP button (26)**

■ Controlling the tuner

To control the AV receiver’s tuner, press **AM** or **FM**.

- ① **Arrow $\blacktriangle/\blacktriangledown$ buttons (20)**
- ② **D.TUN button (21)**
- ③ **DISPLAY button (21)**
- ④ **CH +/- button (21)**
- ⑤ **Number buttons (21)**

Connecting the AV Receiver

Connecting Your Speakers

Connecting the Speaker Cables

The following illustration shows which speaker should be connected to each pair of terminals.

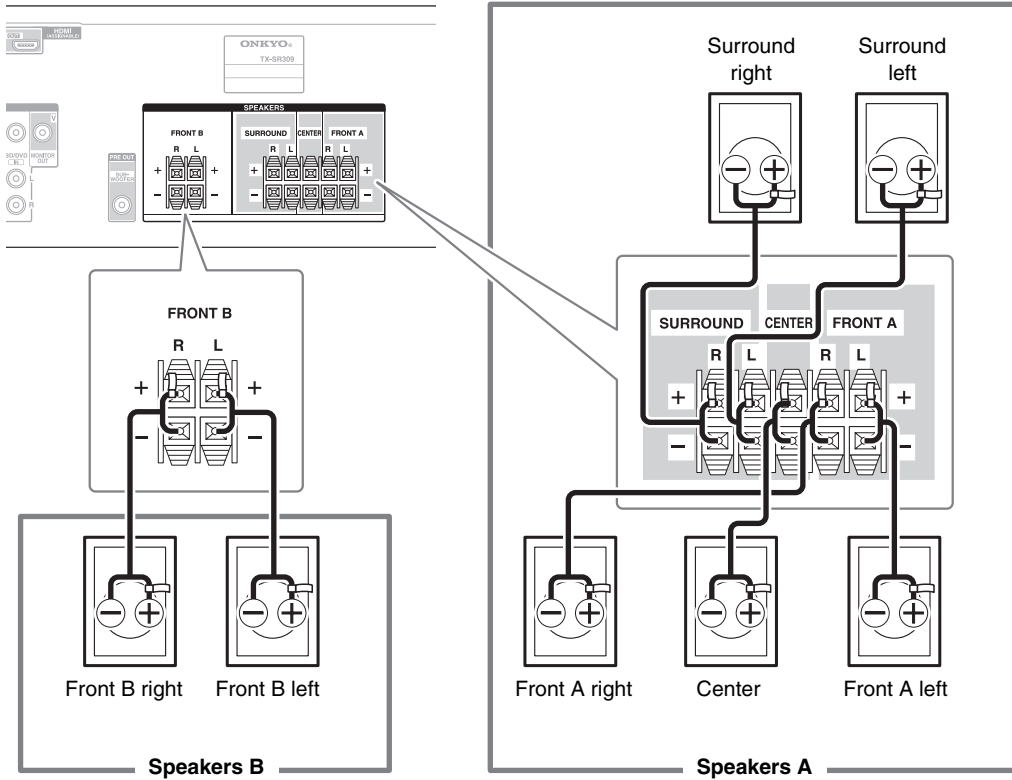

■ Push-type speaker terminals

Strip 3/8" to 1/2" (10 to 12 mm) of insulation from the ends of the speaker cables, and twist the bare wires tightly, as shown.

3/8" to 1/2" (10 to 12 mm)

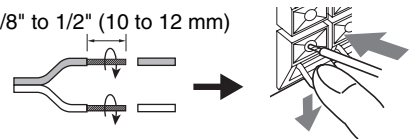

Speaker Configuration

The following table indicates the channels you should use depending on the number of speakers that you have.

No matter how many speakers you use, a powered subwoofer is recommended for a really powerful and solid bass.

To get the best from your surround sound system, you need to set the speaker settings manually (→ **page 31**).

Number of channels	2	3	4	5
Front speakers	✓	✓	✓	✓
Center speaker		✓		✓
Surround speakers			✓	✓

Attaching the Speaker Cable Labels

The speaker terminals are color-coded for identification purpose.

Speaker	Color
Front left	White
Front right	Red
Center	Green
Surround left	Blue
Surround right	Gray

The supplied speaker cable labels are also color-coded and you should attach them to the positive (+) side of each speaker cable in accordance with the table above. Then all you need to do is to match the color of each label to the corresponding speaker terminal.



Speaker Connection Precautions

Read the following before connecting your speakers:

- You can connect speakers with an impedance of between 6 and 16 ohms. If you use speakers with a lower impedance, and use the amplifier at high volume levels for a long period of time, the built-in amp protection circuit may be activated.
- Disconnect the power cord from the wall outlet before making any connections.
- Read the instructions supplied with your speakers.
- Pay close attention to speaker wiring polarity. In other words, connect positive (+) terminals only to positive (+) terminals, and negative (-) terminals only to negative (-) terminals. If you get them the wrong way around, the sound will be out of phase and will sound unnatural.
- Unnecessarily long, or very thin speaker cables may affect the sound quality and should be avoided.
- Be careful not to short the positive and negative wires. Doing so may damage the AV receiver.
- Make sure the metal core of the wire does not have contact with the AV receiver's rear panel. Doing so may damage the AV receiver.

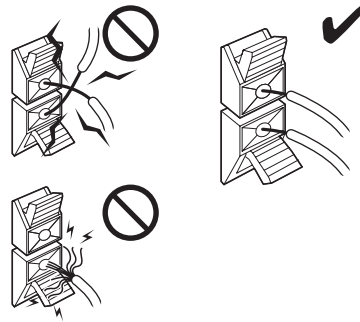

- Don't connect more than one cable to each speaker terminal. Doing so may damage the AV receiver.
- Don't connect one speaker to several terminals.

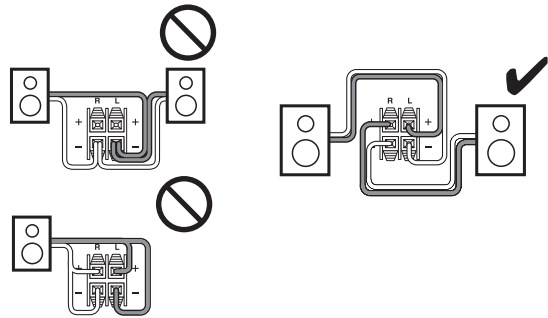

Using a Powered Subwoofer

To find the best position for your subwoofer, while playing a movie or some music with good bass, experiment by placing your subwoofer at various positions within the room, and choose the one that provides the most satisfying results.

Tip

- If your subwoofer is unpowered and you're using an external amplifier, connect the subwoofer pre out jack to an input on the amplifier.

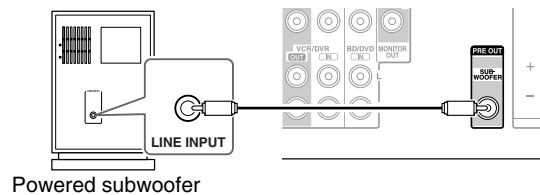

Powered subwoofer

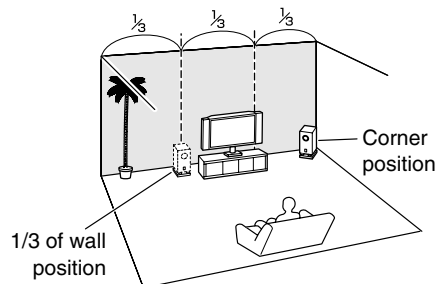



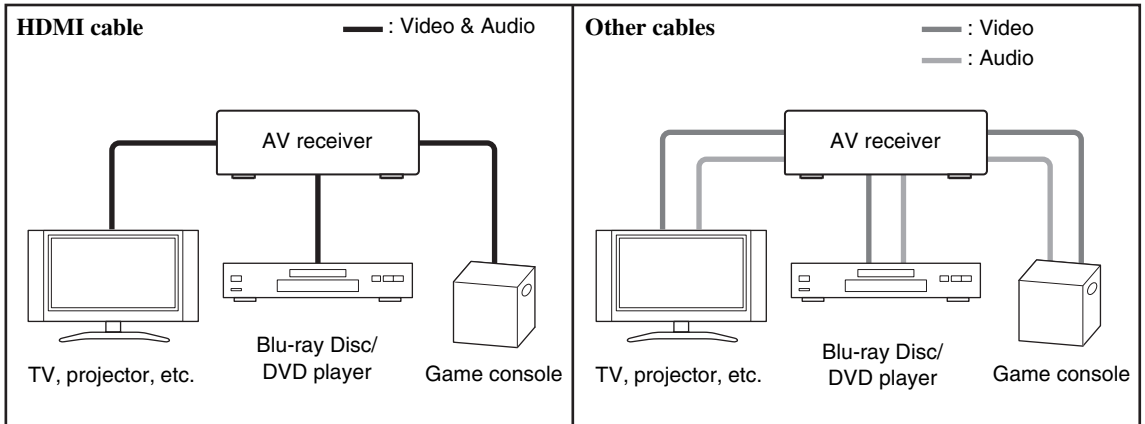

Connected image with AV components

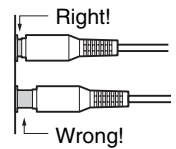

- Before making any AV connections, read the manuals supplied with your AV components.
- Don't connect the power cord until you've completed and double-checked all AV connections.
- Push plugs in all the way to make good connections (loose connections can cause noise or malfunctions).
- To prevent interference, keep audio and video cables away from power cords and speaker cables.

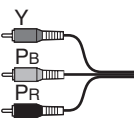

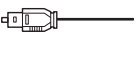
AV Cables and Jacks

Signal	Cable	Jack	Description
Video and Audio	HDMI		HDMI connections can carry digital video and audio.
Video	Component video		Y Green PB Blue PR Red
		Composite video	
Audio	Optical digital audio		Optical digital connections allow you to enjoy digital sound such as PCM*, Dolby Digital or DTS. The audio quality is the same as coaxial.
	Coaxial digital audio		Coaxial digital connections allow you to enjoy digital sound such as PCM*, Dolby Digital or DTS. The audio quality is the same as optical.
	Analog audio (RCA)		L White R Red

* Available sampling rate for PCM input signal is 32/44.1/48/88.2/96 kHz. Even 176.4/192 kHz is effective in case of the HDMI connection.

Note

- The AV receiver does not support SCART plugs.
- The AV receiver's optical digital jacks have shutter-type covers that open when an optical plug is inserted and close when it's removed. Push plugs in all the way.

Caution

- To prevent shutter damage, hold the optical plug straight when inserting and removing.

Connecting Components with HDMI

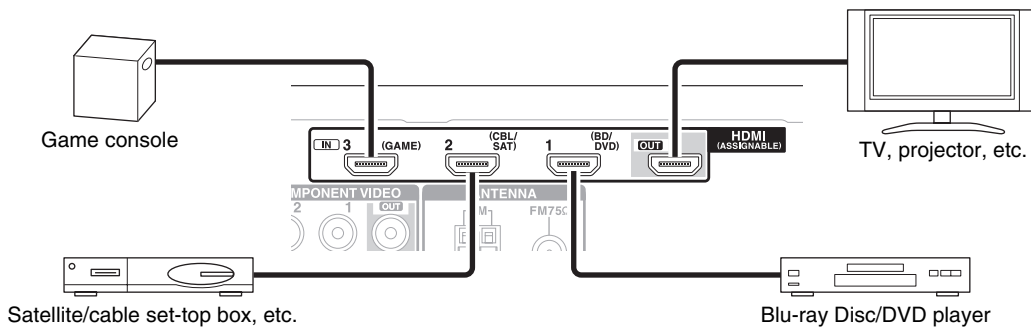

Connect your components to the appropriate jacks. The default input assignments are shown below.

✓: Assignment can be changed (→ page 30).

Jack		Components	Assignable
Input	HDMI IN1	Blu-ray Disc/DVD player	✓
	HDMI IN2	Satellite/cable set-top box, etc.	✓
	HDMI IN3	Game console	✓
Output	HDMI OUT	TV, projector, etc.	

See also:

- “Connection Tips and Video Signal Path” (→ page 47)
- “About HDMI” (→ page 49)
- “Using an RIHD-compatible TV, Player, or Recorder” (→ page 50)

■ Audio return channel (ARC) function

Audio return channel (ARC) function enables an HDMI capable TV to send the audio stream to the **HDMI OUT** of the AV receiver (→ page 35).

- To use ARC function, you must select the **TV/CD** input selector, your TV must support ARC function and “**HDMI Ctrl(RIHD)**” is set to “**On**” (→ page 35).

Tip

- To listen to audio received by the **HDMI IN** jacks through your TV’s speakers:
 - Set the “**HDMI Ctrl(RIHD)**” setting to “**On**” for an **RIHD**-compatible TV.
 - Set the “**Audio TV Out**” setting to “**On**” (→ page 35) when the TV is not compatible with **RIHD** or the “**HDMI Ctrl(RIHD)**” setting to “**Off**”.
 - Set your Blu-ray Disc/DVD player’s HDMI audio output setting to PCM.
 - To listen to TV audio through the AV receiver, see “Connecting Your Components” (→ page 14).

Note

- When listening to an HDMI component through the AV receiver, set the HDMI component so that its video can be seen on the TV screen (on the TV, select the input of the HDMI component connected to the AV receiver). If the TV power is off or the TV is set to another input source, this may result in no sound from the AV receiver or the sound may be cut off.
- When the “**Audio TV Out**” setting is set to “**On**” (→ page 35) to hear from your TV’s speakers, by controlling the AV receiver’s volume, the sound will be output from the AV receiver’s speakers, too. When the “**HDMI Ctrl(RIHD)**” setting is set to “**On**” (→ page 35) to hear from speakers of **RIHD**-compatible TV, by controlling the AV receiver’s volume, the AV receiver’s speakers will produce sound while the TV’s speakers are muted. To stop the AV receiver’s speakers producing sound, change the settings, change your TV’s settings, or turn down the AV receiver’s volume.

Connecting Your Components

The on-screen setup menus appear only on a TV that is connected to the **HDMI OUT**. If your TV is connected to the **MONITOR OUT V** or the **COMPONENT VIDEO OUT**, use the AV receiver's display when changing settings.

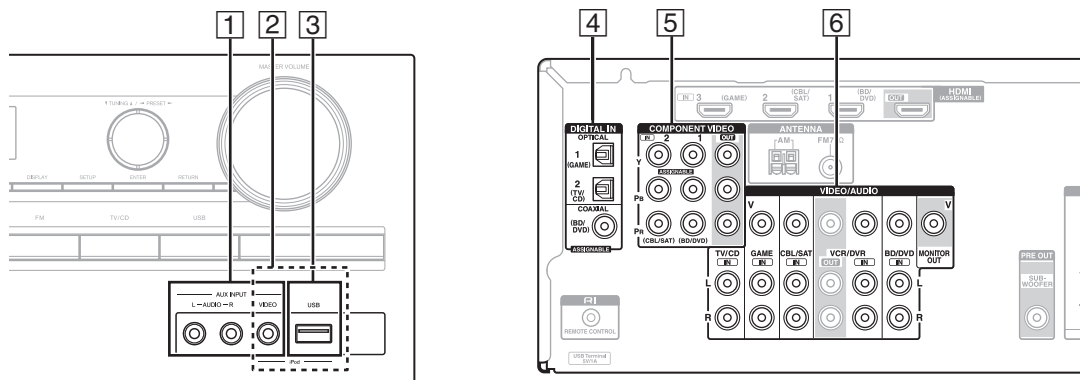

Connect your components to the appropriate jacks. The default input assignments are shown below.

✓: Assignment can be changed (→ page 30).

No.	Jack	Components	Assignable
1	AUX INPUT VIDEO	VIDEO	
		AUDIO L/R	
2	USB, AUX INPUT VIDEO*1	iPod/iPhone (video playback)	
3	USB*2	iPod/iPhone, MP3 player, USB flash drive	
4	DIGITAL IN	OPTICAL	
		1 (GAME)	Game console ✓
		2 (TV/CD)	TV, CD player ✓
5	COMPONENT VIDEO	COAXIAL (BD/DVD)	Blu-ray Disc/DVD player ✓
		IN 1 (BD/DVD)	Blu-ray Disc/DVD player, RI dock ✓
		IN 2 (CBL/SAT)	Satellite/cable set-top box, RI dock, etc. ✓
6	MONITOR OUT	TV, projector, etc.	
	BD/DVD IN	Blu-ray Disc/DVD player	
	VCR/DVR IN	VCR, DVD recorder/Digital Video Recorder, RI dock	
	CBL/SAT IN	Satellite/cable set-top box, etc.	
	GAME IN	Game console, RI dock	
	TV/CD IN	TV, CD player, cassette tape deck, MD, CD-R, Turntable*3, RI dock	

*1 When **USB** input is selected, you can input video signals from the **AUX INPUT VIDEO** jack. Video signals input from **AUX INPUT VIDEO** will be output from the **MONITOR OUT** jack.

*2 Do not connect the AV receiver's **USB** port to a USB port on your computer. Music on your computer cannot be played through the AV receiver in this way.

*3 Connect a turntable (MM) that has a phono preamp built-in. If your turntable (MM) doesn't have it, you'll need a commercially available phono preamp.

If your turntable has a moving coil (MC) type cartridge, you'll need a commercially available MC head amp or MC transformer as well as a phono preamp. See your turntable's manual for details.

• With connection 4, you can enjoy Dolby Digital and DTS.

• If your Blu-ray Disc/DVD player has both the main stereo and multichannel outputs, be sure to connect the main stereo output using connection 6.

■ How to record the video

See "Recording" to make a connection for video recording (→ page 28).

Connecting Onkyo RI Components

- 1 Make sure that each Onkyo component is connected with an analog audio cable (connection ⑥ in the hookup examples) (→ page 14).
- 2 Make the RI connection (see the illustration).
- 3 If you're using an RI Dock or cassette tape deck, change the Input Display (→ page 27).

With RI (Remote Interactive), you can use the following special functions:

■ System On/Auto Power On

When you start playback on a component connected via RI, if the AV receiver is on Standby, it will automatically turn on and select that component as the input source.

■ Direct Change

When playback is started on a component connected via RI, the AV receiver automatically selects that component as the input source.

■ Remote Control

You can use the AV receiver's remote controller to control your other RI-capable Onkyo components, pointing the remote controller at the AV receiver's remote control sensor instead of the component. You must enter the appropriate remote control code first (→ page 40).

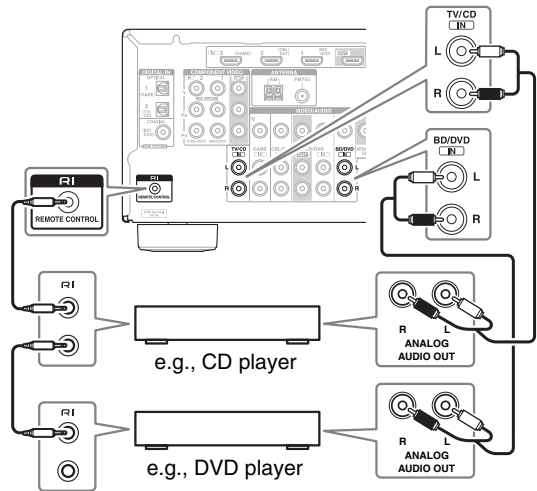

Note

- Use only RI cables for RI connections. RI cables are supplied with Onkyo players (DVD, CD, etc.).
- Some components have two RI jacks. You can connect either one to the AV receiver. The other jack is for connecting additional RI-capable components.
- Connect only Onkyo components to RI jacks. Connecting other manufacturer's components may cause a malfunction.
- Some components may not support all RI functions. Refer to the manuals supplied with your other Onkyo components.

Connecting a Recording Component

See "Recording" on the recording (→ page 28).

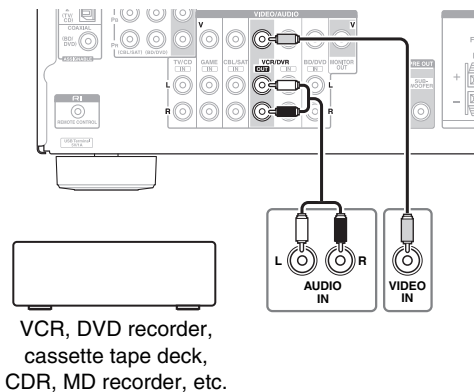

Note

- The AV receiver must be turned on for recording. Recording is not possible while it's in Standby mode.
- If you want to record directly from your TV or playback VCR to the recording VCR without going through the AV receiver, connect the TV/VCR's audio and video outputs directly to the recording VCR's audio and video inputs. See the manuals supplied with your TV and VCR for details.
- Video signals connected to composite video inputs can be recorded only via composite video outputs. If your TV/VCR is connected to a composite video input, the recording VCR must be connected to a composite video output.
- The surround sound and DSP listening modes cannot be recorded.
- Copy-protected Blu-ray discs and DVDs cannot be recorded.
- Sources connected to a digital input cannot be recorded. Only analog inputs can be recorded.
- DTS signals will be recorded as noise, so don't attempt analog recording of DTS CDs or LDs.

Connecting Antenna

This section explains how to connect the supplied indoor FM antenna and AM loop antenna.

The AV receiver won't pick up any radio signals without any antenna connected, so you must connect the antenna to use the tuner.

Caution

- Be careful that you don't injure yourself when using thumbtacks.

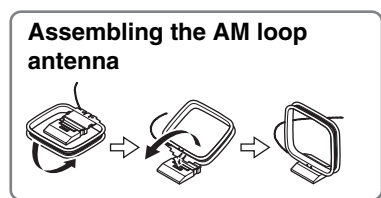
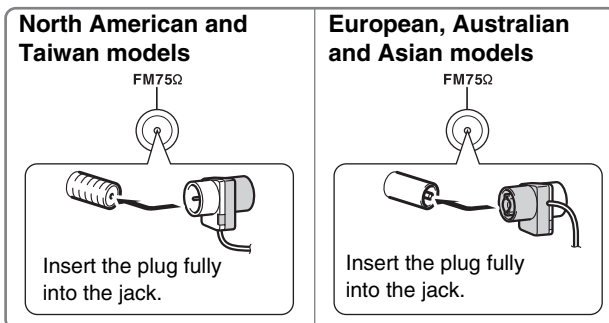
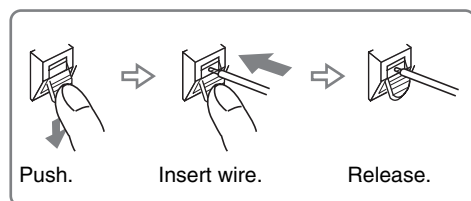

AM loop antenna (supplied)

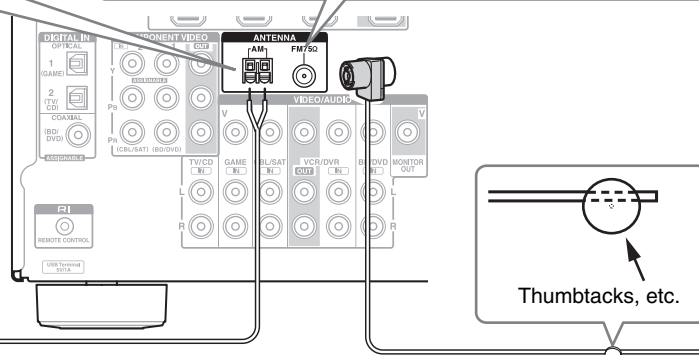

Indoor FM antenna (supplied)

Note

- Once your AV receiver is ready for use, you'll need to tune into a radio station and position the antenna to achieve the best possible reception.
- Keep the AM loop antenna as far away as possible from your AV receiver, TV, speaker cables, and power cords.

Tip

- If you cannot achieve good reception with the supplied indoor FM antenna, try a commercially available outdoor FM antenna instead.
- If you cannot achieve good reception with the supplied indoor AM loop antenna, try using it with a commercially available outdoor AM antenna.

Connecting the Power Cord

- (Taiwan models)**
Connect the supplied power cord to the AV receiver's AC INLET.

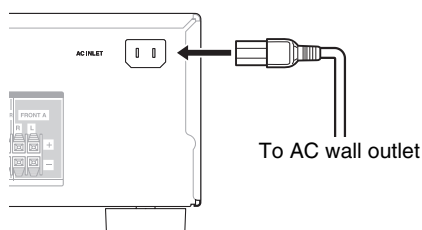

- Plug the power cord into an AC wall outlet.**

Note

- **Before connecting the power cord, connect all of your speakers and AV components.**
- Turning on the AV receiver may cause a momentary power surge that might interfere with other electrical equipment on the same circuit. If this is a problem, plug the AV receiver into a different branch circuit.
- Do not use a power cord other than the one supplied with the AV receiver. The supplied power cord is designed exclusively for use with the AV receiver and should not be used with any other equipment.
- Never disconnect the power cord from the AV receiver while the other end is still plugged into a wall outlet. Doing so may cause an electric shock. Always disconnect the power cord from the wall outlet first, and then the AV receiver.

Turning On/Off the AV Receiver

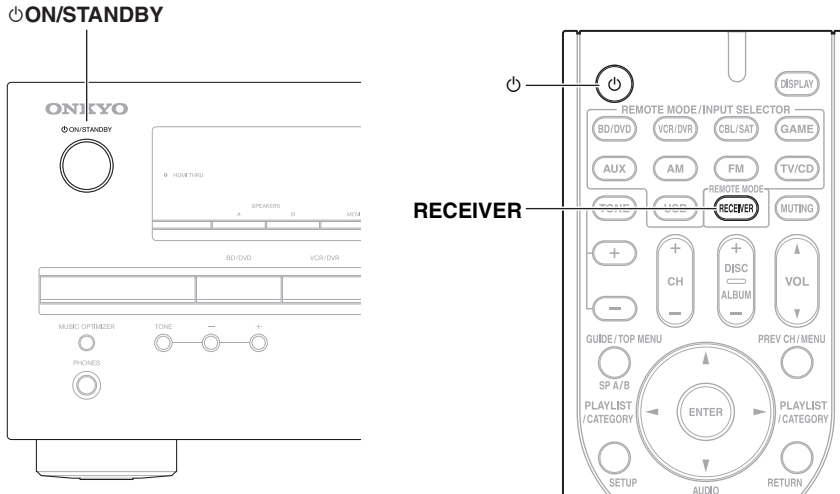

Turning On

- 1 Press **ON/STANDBY** on the front panel.
or
Press **RECEIVER** followed by **ON** on the remote controller.
The AV receiver comes on, the display lights.

Turning Off

- 1 Press **ON/STANDBY** on the front panel.
or
Press **RECEIVER** followed by **ON** on the remote controller.
The AV receiver will enter standby mode. To prevent any loud surprises when you turn on the AV receiver, always turn down the volume before you turn it off.

Tip

- See “Auto Standby” about a power management setting (→ [page 34](#)).

Playback

This manual describes the procedure using the remote controller unless otherwise specified.

Playing the Connected Component

■ Operating with the remote controller

- 1** Press **RECEIVER** followed by **INPUT SELECTOR**.
- 2** Start playback on the source component.
See also:
 - “Playing iPod/iPhone via USB” (→ **page 19**)
 - “Playing USB Device” (→ **page 20**)
 - “Listening to AM/FM Radio” (→ **page 20**)
 - “iPod/iPhone Playback via Onkyo Dock” (→ **page 38**)
 - “Controlling Other Onkyo Components” (→ **page 40**)
- 3** To adjust the volume, use **VOL ▲/▼**.
- 4** Select a listening mode and enjoy!
See also:
 - “Using the Listening Modes” (→ **page 23**)

■ Operating on the AV receiver

- 1** Use the input selector buttons to select the input source.
- 2** Start playback on the source component.
- 3** To adjust the volume, use the **MASTER VOLUME** control.
- 4** Select a listening mode and enjoy!

Controlling Contents of USB Devices

See “Controlling Other Onkyo Components” about the operation of other components (→ **page 40**).

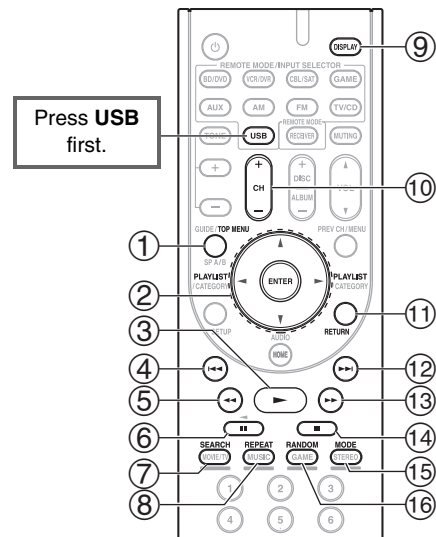

- | | |
|---|---|
| ① | TOP MENU
This button displays the top menu for each media or service. |
| ② | ▲/▼ and ENTER
These buttons navigate through the menus.
◀/▶
This button cycles through pages.
PLAYLIST ◀/▶
In Standard Mode (iPod/iPhone), this button selects playlists. |
| ③ | ▶
This button starts playback. |
| ④ | ◀◀
This button selects the beginning of the current song. Pressing this button twice selects the previous song. |
| ⑤ | ◀◀◀
This button fast-reverses the current song. |
| ⑥ |
This button pauses playback. |
| ⑦ | SEARCH
You can toggle between the playback screen and the list screen during playback. |
| ⑧ | REPEAT
Press this button repeatedly to cycle through the repeat modes.
To cancel repeat playback, press REPEAT repeatedly until you select Off. |
| ⑨ | DISPLAY
This button switches between song informations. |













⑩	CH +/- In Standard Mode (iPod/iPhone), this button selects albums.
⑪	RETURN This button returns to the previous menu.
⑫	▶▶ This button selects the next song.
⑬	▶▶▶ This button fast-forwards the current song.
⑭	■ This button stops playback.
⑮	MODE You can switch between Standard Mode and Extended Mode during iPod/iPhone playback.
⑯	RANDOM This button performs random playback. All of the songs in the current folder will be played in random order. When all of the songs in the folder have been played once, they'll all be played again in a different random order. To cancel random playback, press this button again.

Note

- The buttons you can use will differ depending on the devices and media used for playback.

Understanding Icons on the Display

This section describes icons that appear on the display during media playback.

Displayed Icons	
Icon	Description
	Folder
	Track
	Playback
	Pause
	Fast Forward
	Fast Reverse
	Artist
	Album
	Repeat One Track
	Repeat Folder (USB Device)
	Repeat
	Shuffle
	Shuffle Album (iPod/iPhone)

Playing iPod/iPhone via USB

The on-screen navigation menus appear only on a TV that is connected to the HDMI OUT.

This section explains how to play music files on the iPod/iPhone.

Compatible iPod/iPhone models

Made for:

iPod touch (1st, 2nd, 3rd and 4th generation), iPod classic, iPod with video, iPod nano (1st, 2nd, 3rd, 4th, 5th and 6th generation), iPhone 4, iPhone 3GS, iPhone 3G, iPhone

- 1 Press USB to select the “USB” input.**
- 2 Connect the USB cable that comes with the iPod/iPhone to the USB port at the front of the AV receiver.**
While reading the contents of your iPod/iPhone, the message “**Connecting...**” appears on the display.
- 3 Press MODE to switch to Extended Mode.**
A list of your iPod/iPhone model’s contents appears. Use ▲/▼ to open a folder, and then press **ENTER**.

Tip

- With the default settings, iPod/iPhone is operated in Standard Mode.
- Pressing **MODE** again switches back to Standard Mode.
- When you disconnect the iPod/iPhone, the AV receiver stores the mode. This means that if you disconnect when in Extended Mode, the AV receiver will start in Extended Mode when you next connect the iPod/iPhone.
- You can also use the ▲/▼, **ENTER** and **TUNING MODE** buttons on the front panel. **TUNING MODE** allows you to switch modes.
- When connecting your iPod/iPhone with a USB cable, we recommend you use an official USB cable from Apple Inc.

- 4 Use ▲/▼ to select a music file, and press ENTER or ▶ to start playback.**

Note

- Do not disconnect the USB device or USB cable that comes with iPod/iPhone to the **USB** port at the front of the AV receiver, while the message “**Connecting...**” appears on the display.

Standard Mode control

The content information is not displayed on-screen, but can be operated using the iPod/iPhone or the remote controller (**USB**).

Note

- The following iPod models are not supported in Standard Mode. These iPod models can only be controlled in Extended Mode.
 - iPod with video
 - iPod nano (1st generation)

Extended Mode control

The content information is displayed (lists are displayed) on-screen, and you can control the content while looking at the screen.

Top screen list:

Playlists, Artists, Albums, Genres, Songs, Composers, Shuffle Songs, Now Playing

Playing USB Device

The on-screen navigation menus appear only on a TV that is connected to the HDMI OUT.

This section explains how to play music files on a USB device (e.g., USB flash drives and MP3 players).

See also:

- “USB Features” (→ page 48).

1 Press **USB** to select the “USB” input.

2 Plug your USB device into the **USB** port at the front of the AV receiver.

While reading the contents of your USB device, the message “Connecting...” appears on the display.

3 Press **ENTER**.

A list of the device’s contents appears. To open a folder, use ▲/▼ to select it, and then press **ENTER**.

4 Use ▲/▼ to select a music file, and press **ENTER** or ► to start playback.

Note

- If the media you connect is not supported, the message “No Storage” will appear on the display.
- If you connect a USB hard disk drive to the AV receiver’s **USB** port, we recommend that you use its AC adapter to power it.
- The AV receiver supports USB MP3 players that support the USB Mass Storage Class standard, which allows USB storage devices to be connected to computers without the need for special drivers or software. Note that not all USB MP3 players support the USB Mass Storage Class standard. Refer your USB MP3 player’s instruction manual for details.
- Protected WMA music files on an MP3 player cannot be played.
- Onkyo accepts no responsibility whatsoever for the loss or damage to data stored on a USB mass storage device when that device is used with the AV receiver. We recommend that you back up your important music files beforehand.
- MP3 players containing music files that are managed with special music software are not supported.
- Operation with all USB mass storage devices including the ability to power them is not guaranteed.
- Do not connect your USB mass storage device via a USB hub. The USB mass storage device must be connected directly to the AV receiver’s **USB** port.
- If the USB mass storage device contains a lot of data, the AV receiver may take a while to read it.
- USB memory devices with security functions cannot be played.
- Do not disconnect the USB device or USB cable that comes with iPod/iPhone to the **USB** port at the front of the AV receiver, while the message “Connecting...” appears on the display.

Listening to AM/FM Radio

This section describes the procedure using the buttons on the front panel unless otherwise specified.

Using the Tuner

With the built-in tuner you can enjoy AM and FM radio stations. You can store your favorite stations as presets for quick selection.

You can change the frequency steps (→ page 34).

- 1** Press **AM** or **FM** to select either “AM” or “FM”. In this example, FM has been selected.

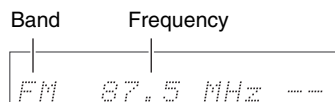

(Actual display depends on the country.)

Tuning into Radio Stations

■ Auto tuning mode

- 1** Press **TUNING MODE** so that the **AUTO** indicator lights on the display.

2 Press **TUNING** ▲/▼.

Searching stops when a station is found.

When tuned into a station, the **TUNED** indicator lights. When tuned into a stereo FM station, the **FM STEREO** indicator lights on the display, as shown.

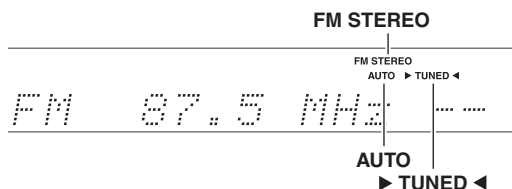

Tip

- **Tuning into weak FM stereo stations**
If the signal from a stereo FM station is weak, it may be impossible to get good reception. In this case, switch to manual tuning mode and listen to the station in mono.
- Alternatively, you can use the remote controller’s **MODE** and arrow buttons.

■ Manual tuning mode

In manual tuning mode, FM stations will be in mono.

- 1 Press TUNING MODE** so that the **AUTO** indicator goes off on the display.
- 2 Press and hold TUNING ▲/▼.**
The frequency stops changing when you release the button.
Press the buttons repeatedly to change the frequency one step at a time.

■ Tuning into stations by frequency

You can tune into AM and FM stations directly by entering the appropriate frequency.

- 1 On the remote controller, press AM or FM** to select “AM” or “FM”, followed by **D.TUN.**

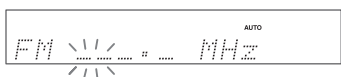

(Actual display depends on the country.)

- 2 Within 8 seconds, use the number buttons to enter the frequency of the radio station.**
For example, to tune to 87.5 (FM), press **8, 7, 5.**
If you have entered the wrong number, you can retry after 8 seconds.

Presetting AM/FM Stations

You can store a combination of up to 40 of your favorite AM/FM radio stations as presets.

- 1 Tune into the AM/FM station that you want to store as a preset.**

See the previous section.

- 2 Press MEMORY.**

The preset number flashes.

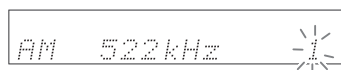

(Actual display depends on the country.)

- 3 While the preset number is flashing (about 8 seconds), use PRESET ◀/▶ to select a preset from 1 through 40.**

- 4 Press MEMORY again to store the station or channel.**

The station or channel is stored and the preset number stops flashing.

Repeat this procedure for all of your favorite AM/FM radio stations.

■ Selecting Presets

- 1 To select a preset, use PRESET ◀/▶ on the AV receiver, or the remote controller's CH +/-.**

Tip

- You can also use the remote controller's number buttons to select a preset directly.

■ Deleting Presets

- 1 Select the preset that you want to delete.**
See the previous section.
- 2 While holding down MEMORY, press TUNING MODE.**
The preset is deleted and its number disappears from the display.

Using RDS (excluding North American and Taiwan models)

RDS works only in areas where RDS broadcasts are available.

When tuned into an RDS station, the **RDS** indicator lights. When the station is broadcasting text information, the text can be displayed.

■ What is RDS?

RDS stands for Radio Data System and is a method of transmitting data in FM radio signals. It was developed by the European Broadcasting Union (EBU) and is available in most European countries. Many FM stations use it these days. In addition to displaying text information, RDS can also help you find radio stations by type (e.g., news, sport, rock, etc.).

The AV receiver supports four types of RDS information:

PS (Program Service)

When tuned to an RDS station that's broadcasting PS information, the station's name will be displayed. Pressing **DISPLAY** will display the frequency for 3 seconds.

RT (Radio Text)

When tuned to an RDS station that's broadcasting text information, the text will be shown on the display as described in the next section.

PTY (Program Type)

This allows you to search for RDS radio stations by type (→ **page 22**).

TP (Traffic Program)

This allows you to search for RDS radio stations that broadcast traffic information (→ **page 22**).

Note

- In some cases, the text characters displayed on the AV receiver may not be identical to those broadcast by the radio station. Also, unexpected characters may be displayed when unsupported characters are received. This is not a malfunction.
- If the signal from an RDS station is weak, RDS data may be displayed intermittently or not at all.

■ Displaying Radio Text (RT)

1 Press RT/PTY/TP once.

The RT information scrolls across the display.

Note

- The message “**Waiting**” may appear while the AV receiver waits for the RT information.
- If the message “**No Text Data**” appears on the display, no RT information is available.

■ Finding Stations by Type (PTY)

You can search for radio stations by type.

1 Press RT/PTY/TP twice.

The current program type appears on the display.

2 Use PRESET ◀/▶ to select the type of program you want.

See the table shown later in this chapter.

3 To start the search, press ENTER.

The AV receiver searches until it finds a station of the type you specified, at which point it stops briefly before continuing with the search.

4 When a station you want to listen to is found, press ENTER.

If no stations are found, the message “**Not Found**” appears.

■ Listening to Traffic News (TP)

You can search for stations that broadcast traffic news.

1 Press RT/PTY/TP three times.

If the current radio station is broadcasting TP (Traffic Program), “[TP]” will appear on the display, and traffic news will be heard as and when it’s broadcast. If “**TP**” without square brackets appears, this means that the station is not broadcasting TP.

2 To locate a station that is broadcasting TP, press ENTER.

The AV receiver searches until it finds a station that’s broadcasting TP.

If no stations are found, the message “**Not Found**” appears.

RDS program types (PTY)

Type	Display
None	None
News reports	News
Current affairs	Affairs
Information	Info
Sport	Sport
Education	Educate
Drama	Drama
Culture	Culture
Science and technology	Science
Varied	Varied
Pop music	Pop M
Rock music	Rock M
Middle of the road music	Easy M
Light classics	Light M
Serious classics	Classics
Other music	Other M
Weather	Weather
Finance	Finance
Children’s programmes	Children
Social affairs	Social
Religion	Religion
Phone in	Phone In
Travel	Travel
Leisure	Leisure
Jazz music	Jazz
Country music	Country
National music	Nation M
Oldies music	Oldies
Folk music	Folk M
Documentary	Document
Alarm test	TEST
Alarm	Alarm!

Using Basic Functions

Using the Listening Modes

Selecting Listening Modes

See “Listening Modes” for detailed information about the listening modes (→ page 24).

■ Listening Mode Buttons

MOVIE/TV button

This button selects the listening modes intended for use with movies and TV.

MUSIC button

This button selects the listening modes intended for use with music.

GAME button

This button selects the listening modes intended for use with video games.

STEREO button

This button selects the Stereo listening mode and All Channel Stereo listening mode.

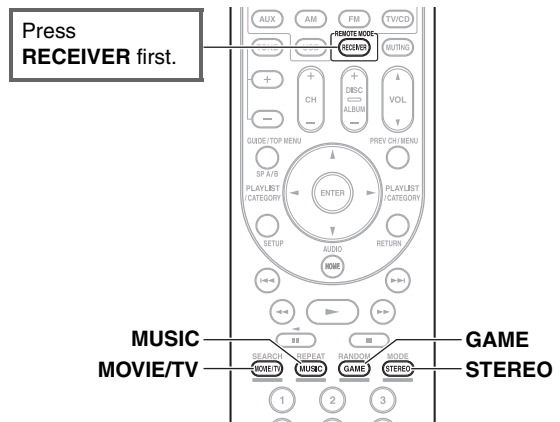

- The Dolby Digital and DTS listening modes can only be selected if your Blu-ray Disc/DVD player is connected to the AV receiver with a digital audio connection (coaxial, optical, or HDMI).
- The listening modes you can select depends on the format of the input signal. To check the format, see “Displaying Source Information” (→ page 27).
- While a pair of headphones is connected, you can select the following listening modes: Mono, Direct, and Stereo.
- While Speakers A and B are on, you can select only the Direct, Stereo, Mono, or T-D (Theater-Dimensional) listening mode.

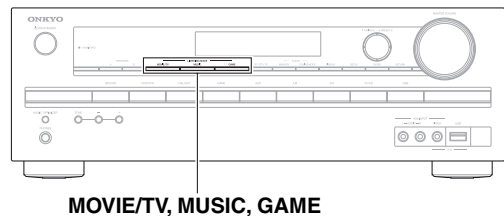

About Listening Modes

The AV receiver’s listening modes can transform your listening room into a movie theater or concert hall, with high fidelity and stunning surround sound.

■ Explanatory Notes

Input Source

The following audio formats are supported by the listening mode.

MONO	This is mono (monophonic) sound.
STEREO	This is stereo (stereophonic) sound. Two independent audio signal channels are reproduced through two speakers.
5.1ch	This is 5.1-channel surround sound. This surround system has five main channels of sound and a sixth subwoofer channel (called the point-one channel).
7.1ch ^{*1}	This is 7.1-channel surround sound. This is a further sound enhancement to 5.1 channel sound with two additional speakers that provide greater sound envelopment and more accurate positioning of sounds.

^{*1} The AV receiver outputs this source in 5.1-channel surround sound.

Speaker Layout

The illustration shows which speakers are activated in each channel. See “Sp Config (Speaker Configuration)” for the speaker setup (→ **page 31**).

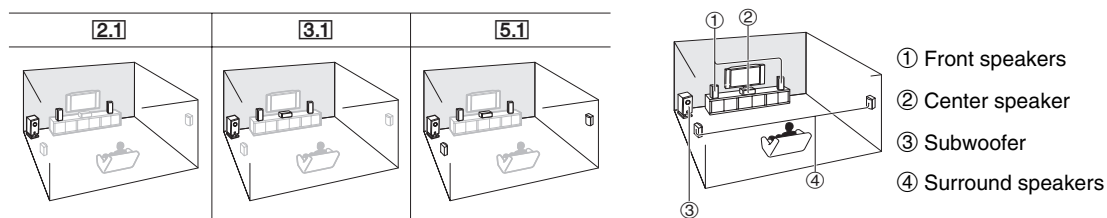

■ Onkyo-Original DSP Listening Modes

Listening Mode	Description	Input Source	Speaker Layout
Orchestra ^{*1} <i>Orchestra</i>	Suitable for classical or operatic music, this mode emphasizes the surround channels in order to widen the stereo image, and simulates the natural reverberation of a large hall.	MONO STEREO 5.1ch 7.1ch	5.1
Unplugged ^{*1} <i>Unplugged</i>	Suitable for acoustic instruments, vocals, and jazz, this mode emphasizes the front stereo image, giving the impression of being right in front of the stage.		
Studio-Mix ^{*1} <i>Studio-Mix</i>	Suitable for rock or pop music, listening to music in this mode creates a lively sound field with a powerful acoustic image, like being at a club or rock concert.		
TV Logic ^{*1} <i>TV Logic</i>	This mode adds realistic acoustics to TV shows produced in a TV studio, surround effects to the entire sound, and clarity to voices.		
Game-RPG ^{*1} <i>Game-RPG</i>	In this mode, the sound has a dramatic feel with a similar atmosphere to Orchestra mode.		
Game-Action ^{*1} <i>Game-Action</i>	In this mode, sound localization is distinct with emphasis on bass.		
Game-Rock ^{*1} <i>Game-Rock</i>	In this mode, sound pressure is emphasized to heighten live feel.		
Game-Sports ^{*1} <i>Game-Sports</i>	In this mode, reverberation is increased and sound localization decreased slightly.		
All Ch Stereo <i>All Ch Stereo</i>	Ideal for background music, this mode fills the entire listening area with stereo sound from the front, surround, and surround back speakers.		3.1 5.1
Full Mono <i>Full Mono</i>	In this mode, all speakers output the same sound in mono, so the sound you hear is the same regardless of where you are within the listening room.		
T-D (Theater-Dimensional) ^{*1} <i>T-D</i>	With this mode you can enjoy a virtual surround sound even with only two or three speakers. This works by controlling how sounds reach the listener's left and right ears. Good results may not be possible if there's too much reverb, so we recommend that you use this mode in an environment with little or no natural reverb.		2.1 3.1 5.1

■ Listening Modes

Listening Mode	Description	Input Source	Speaker Layout
Direct <i>Direct</i>	In this mode, audio from the input source is output without surround-sound processing. The speaker configuration (presence of speakers) and speaker distance settings are enabled, but much of the processing set via Home menu is disabled. A/V Sync does not have effect on the analog audio. See “Advanced Setup” for more details (→ page 29).	MONO STEREO 5.1ch 7.1ch	2.1 3.1 5.1
Stereo <i>Stereo</i>	Sound is output from the front left and right speakers and subwoofer.		
Mono <i>Mono</i>	Use this mode when watching an old movie with a mono soundtrack, or use it with the foreign language soundtracks recorded in the left and right channels of some movies. It can also be used with DVDs or other sources containing multiplexed audio, such as karaoke DVDs.		

Listening Mode	Description	Input Source	Speaker Layout	
Multichannel <i>Multich</i>	This mode is for use with PCM multichannel sources.	5.1ch	3.1 5.1	
Dolby Pro Logic II <i>PLII Movie</i> <i>PLII Music</i> <i>PLII Game</i>	Dolby Pro Logic II expands any 2-channel source for 5.1-channel playback. It provides a very natural and seamless surround-sound experience that fully envelops the listener. As well as music and movies, video games can also benefit from the dramatic spatial effects and vivid imaging. <ul style="list-style-type: none"> • Dolby PLII Movie Use this mode with DVDs and videos that bear the Dolby Surround logo or TV shows that feature Dolby Surround. You can also use this mode with stereo movies or TV shows and the AV receiver will create a 5.1 surround mix from the 2-channel stereo. • Dolby PLII Music Use this mode to add 5.1 surround to stereo sources such as music CDs and DVDs. • Dolby PLII Game Use this mode when playing game discs. 	STEREO	3.1 5.1	
Dolby Digital <i>Dolby D</i>	In this mode, audio from the input source is output without surround-sound processing. The speaker configuration (presence of speakers), crossover frequency, speaker distance, A/V Sync and much of the processing set via Home menu are enabled. See “Advanced Setup” for more details (→ page 29).	5.1ch 7.1ch	3.1 5.1	
Dolby Digital Plus*2 <i>Dolby D +</i>				
Dolby TrueHD <i>Dolby TrueHD</i>				
DTS <i>DTS</i>		5.1ch	3.1 5.1	
DTS-HD High Resolution Audio <i>DTS-HD HR</i>		5.1ch 7.1ch	3.1 5.1	
DTS-HD Master Audio <i>DTS-HD MSTR</i>				
DTS Express <i>DTS Express</i>		5.1ch	3.1 5.1	
DSD*3 <i>DSD</i>				
DTS 96/24 <i>DTS 96/24</i>		This mode is for use with DTS 96/24 sources. This is high-resolution DTS with a 96 kHz sampling rate and 24-bit resolution, providing superior fidelity. Use it with DVDs that bear the DTS 96/24 logo.	5.1ch	3.1 5.1
Neo:6 <i>Neo:6 Cinema</i> <i>Neo:6 Music</i>		This mode expands any 2-channel source for up to 5.1-channel playback. It uses seven full-bandwidth channels of matrix decoding for matrix-encoded material, providing a very natural and seamless surround sound experience that fully envelops the listener. <ul style="list-style-type: none"> • Neo:6 Cinema Use this mode with any stereo movie (e.g., TV, DVD, VHS). • Neo:6 Music Use this mode with any stereo music source (e.g., CD, radio, cassette, TV, VHS, DVD). 	STEREO	3.1 5.1

Note

*1 These listening modes cannot be selected during USB or iPod playback.

*2 For the Blu-ray Discs, Dolby Digital is used.

*3 AV receiver can input the DSD signal from HDMI IN. Setting the output setting on the player side to PCM might obtain a better sound according to the player. In that case, set the output setting on the player side to PCM.

• The listening modes cannot be selected with some source formats.

Setting the Display Brightness

You can adjust the brightness of the AV receiver's display.

- 1 Press **RECEIVER** followed by **DIMMER** repeatedly to select: **dim**, **dimmer**, or **normal** brightness.

Tip

- (North American and Taiwan models) Alternatively, you can use the AV receiver's **DIMMER**.

Displaying Source Information

You can display various information about the current input source as follows.

- 1 Press **RECEIVER** followed by **DISPLAY** repeatedly to cycle through the available information.

The following information can typically be displayed.



Tip

- Alternatively, you can use the AV receiver's **DISPLAY**.
- *1 When AM or FM radio is used, the band, preset number, and frequency are displayed.
- * If the input signal is analog, "Analog" is displayed. If the input signal is PCM, the sampling frequency is displayed. If the input signal is digital but not PCM, the signal format is displayed. Information is displayed for about three seconds, then the previously displayed information reappears.

Changing the Input Display

When you connect an **RI**-capable Onkyo component, you must configure the input display so that **RI** can work properly.

This setting can be done only from the front panel.

- 1 Press **TV/CD**, **GAME** or **VCR/DVR**. "TV/CD", "GAME" or "VCR/DVR" appears on the display.
- 2 Press and hold down the same button (about 3 seconds) to change the input display. Repeat this step to select the desired input display.

■ TV/CD:

TV/CD → DOCK
↑ TAPE ←

■ GAME:

GAME ↔ DOCK

■ VCR/DVR:

VCR/DVR ↔ DOCK

Note

- **DOCK** cannot be selected for multiple input selectors at the same time.
- Enter the appropriate remote control code before using the remote controller for the first time (→ page 40).

Using the Music Optimizer

The Music Optimizer function enhances the sound quality of compressed music files.

- 1 Press **MUSIC OPTIMIZER** on the front panel. The **M.Opt** indicator lights on the display.

Tip

- Alternatively, you can use the remote controller's **HOME** and arrow buttons.
- See "Music Optimizer" for more details (→ page 37).

Muting the AV Receiver

You can temporarily mute the output of the AV receiver.

1 Press **RECEIVER** followed by **MUTING**.

The output is muted and the **MUTING** indicator flashes on the display.

Tip

- To unmute, press **MUTING** again or adjust the volume.
- The mute is cancelled when the AV receiver is set to Standby.

Using Headphones

1 Connect a pair of stereo headphones with a standard plug (1/4 inch or 6.3 mm) to the **PHONES** jack.

Note

- Always turn down the volume before connecting your headphones.
- While the headphones plug is inserted in the **PHONES** jack, the speakers are turned off.
- When you connect a pair of headphones, the listening mode is set to Stereo, unless it's already set to Stereo, Mono, or Direct.

Recording

This section explains how to record the selected input source to a component with recording capability, and how to record audio and video from different sources.

AV Recording

Audio sources can be recorded to a recorder (e.g., cassette tape deck, CDR, MD recorder). Video sources can be recorded to a video recorder (e.g., VCR, DVD recorder).

1 Use the input selector buttons to select the source that you want to record.

You can watch the source while recording. The AV receiver's **MASTER VOLUME** control has no effect on recording.

2 On your recorder, start recording.

3 On the source component, start playback.

If you select another input source during recording, that input source will be recorded.

Recording Separate AV Sources

Here you can record audio and video from completely separate sources, allowing you to overdub audio onto your video recordings. This function takes advantage of the fact that when an audio-only input source (TV/CD) is selected, the video input source remains unchanged.

In the following example, audio from the CD player connected to the **TV/CD IN** and video from the camcorder connected to the **AUX INPUT VIDEO** are recorded by the VCR connected to the **VCR/DVR OUT** jacks.

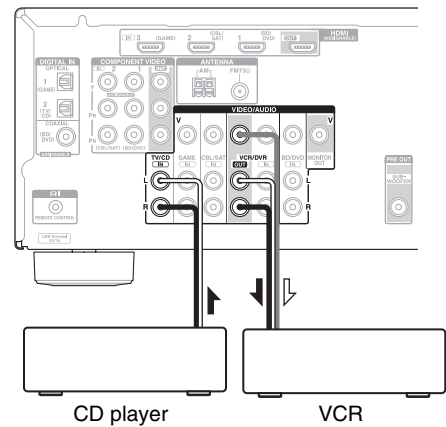
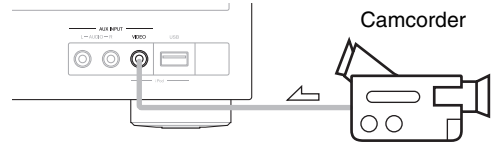

↗ : Video signal
↘ : Audio signal

1 Prepare the camcorder and CD player for playback.

2 Prepare the VCR for recording.

3 Press **AUX** input selector.

4 Press **TV/CD** input selector.

This selects the CD player as the audio source, but leaves the camcorder as the video source.

5 Start recording on the VCR and start playback on the camcorder and CD player.

The video from the camcorder and the audio from the CD player are recorded by the VCR.

Advanced Setup

On-screen Setup Menus

The on-screen setup menus appear only on a TV that is connected to the HDMI OUT. If your TV is connected to the MONITOR OUT V or the COMPONENT VIDEO OUT, use the AV receiver's display when changing settings.

Note

- The on-screen setup menus are displayed when:
 - There is no video input, or
 - The video input is 480p, 576p, 720p, 1080i, or 1080p.

Setup Menu		
①	1. HDMI Input	BD/DVD
②	2. Component	VCR/DVR
③	3. Digital Audio	CBL/SAT
④	4. Sp Config	GAME
⑤	5. Sp Distance	AUX
⑥	6. Level Cal	TUNER
⑦	7. Audio Adjust	TV/CD
⑧	8. Source Setup	
⑨	9. Hardware	
⑩	10. HDMI Setup	

① HDMI Input (→ page 30)

BD/DVD
VCR/DVR
CBL/SAT
GAME
AUX
TUNER
TV/CD

② Component (→ page 30)

BD/DVD
VCR/DVR
CBL/SAT
GAME
AUX
TUNER
TV/CD

③ Digital Audio (→ page 30)

BD/DVD
VCR/DVR
CBL/SAT
GAME
AUX
TUNER
TV/CD

④ Sp Config (→ page 31)

Subwoofer
Front
Center
Surround
Crossover
Double Bass

⑤ Sp Distance (→ page 31)

Unit
Left
Center
Right
Surround Right
Surround Left
Subwoofer

⑥ Level Cal (→ page 32)

Left
Center
Right
Surround Right
Surround Left
Subwoofer

⑦ Audio Adjust (→ page 32)

Input Ch (Mux)
Input Ch (Mono)
Panorama
Dimension
Center Width
Center Image
Listening Angle

⑧ Source Setup (→ page 33)

A/V Sync
Name
Audio Selector
Fixed Mode

⑨ Hardware (→ page 34)

Volume OSD
Remote ID
AM/FM Freq Step
Auto Standby

⑩ HDMI Setup (→ page 35)

HDMI CtrI (RIHD)
HDMI Through
Audio TV Out
Audio Return Ch
LipSync

Common Procedures in Setup Menu

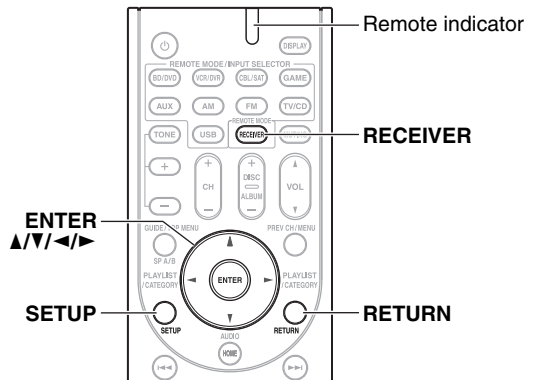

The on-screen setup menus appear on the connected TV and provide a convenient way to change the AV receiver's various settings. Settings are organized into 10 categories on the main menu.

Carry out the settings by using the on-screen display.

1 Press RECEIVER followed by SETUP.

Tip

- If the main menu doesn't appear, make sure the appropriate external input is selected on your TV.

2 Use ▲/▼ to select a menu, and then press ENTER.

3 Use ▲/▼ to select target, and use ◀/▶ to change the setting.

Press **SETUP** to close the menu.

Press **RETURN** to return to the main menu.

Note

- This procedure can also be performed on the AV receiver by using **SETUP**, arrow buttons, and **ENTER**.

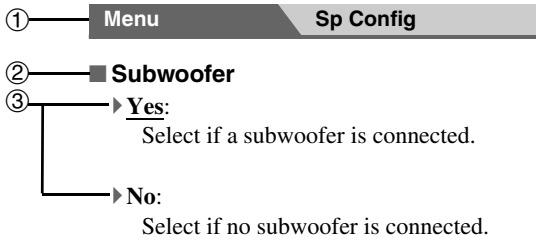

- ① Menu selection
- ② Setting target
- ③ Setting options (default setting underlined)

HDMI Input

Menu HDMI Input

If you connect a video component to an HDMI input, you must assign that input to an input selector. For example, if you connect your Blu-ray Disc/DVD player to **HDMI IN 2**, you must assign “**HDMI2**” to the “**BD/DVD**” input selector.

Here are the default assignments.

Input selector	Default assignment
BD/DVD	HDMI1
VCR/DVR	-----
CBL/SAT	HDMI2
GAME	HDMI3
AUX	-----
TV/CD	-----

■ BD/DVD, VCR/DVR, CBL/SAT, GAME, AUX, TV/CD

▶ HDMI1, HDMI2, HDMI3:

Select a corresponding HDMI input that the video component has been connected.

▶ -----:

Select if you're not using the **HDMI OUT**.

Each HDMI input cannot be assigned to two input selectors or more. When **HDMI1 - HDMI3** have already been assigned, you must set first any unused input selectors to “-----”, or you will be unable to assign **HDMI1 - HDMI3** to input selector.

Note

- When an **HDMI IN** is assigned to an input selector as explained here, the digital audio input for that input selector is automatically set to the same **HDMI IN**.
- Do not assign the component connected with the HDMI input to **TV/CD** selector when you set “**HDMI Ctrl (RIHD)**” setting to “**On**” (→ **page 35**). Otherwise, appropriate CEC (Consumer Electronics Control) operation will not be guaranteed.

Component (Component Video Input)

Menu Component

If you connect a video component to a component video input, you must assign that input to an input selector. For example, if you connect your Blu-ray Disc/DVD player to **COMPONENT VIDEO IN 2**, you must assign “**IN2**” to the “**BD/DVD**” input selector.

Here are the default assignments.

Input selector	Default assignment
BD/DVD	IN1
VCR/DVR	-----
CBL/SAT	IN2
GAME	-----
AUX	-----
TV/CD	-----

■ BD/DVD, VCR/DVR, CBL/SAT, GAME, AUX, TV/CD

▶ IN1, IN2:

Select a corresponding component video input that the video component has been connected.

▶ -----:

Select if you're not using the **COMPONENT VIDEO OUT**.

Digital Audio (Digital Audio Input)

Menu Digital Audio

If you connect a component to a digital audio input, you must assign that input to an input selector. For example, if you connect your CD player to the **OPTICAL IN 1**, you must assign “**OPTICAL1**” to the “**TV/CD**” input selector.

Here are the default assignments.

Input selector	Default assignment
BD/DVD	COAXIAL
VCR/DVR	-----
CBL/SAT	-----
GAME	OPTICAL1
AUX	-----
TV/CD	OPTICAL2

■ BD/DVD, VCR/DVR, CBL/SAT, GAME, AUX, TV/CD

▶ COAXIAL, OPTICAL1, OPTICAL2:

Select a corresponding digital audio input that the component has been connected.

▶ -----:

Select if the component is connected to an analog audio input.

Note

- When an **HDMI IN** is assigned to an input selector in “**HDMI Input**” (→ **page 30**), this input assignment is automatically set to the same **HDMI IN**. And in addition to the usual inputs (e.g., **COAXIAL**, etc.), you can also select HDMI inputs.

- Available sampling rate for PCM signals from a digital input (optical and coaxial) is 32/44.1/48/88.2/96 kHz/16, 20, 24 bit.

Sp Config (Speaker Configuration)

Menu Sp Config

This section explains how to specify which speakers are connected and their sizes.

For speakers with a cone diameter larger than 6-1/2 inches (16 cm), specify **Large** (full band). For those with a smaller diameter, specify **Small** (default crossover 100 Hz).

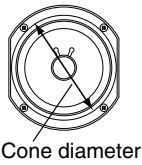

The crossover frequency can be changed in the “Crossover (Crossover Frequency)” (→ **page 31**).

Note

- These settings are disabled when:
 - a pair of headphones is connected, or
 - the “**Audio TV Out**” setting is set to “**On**” (→ **page 35**), or
 - “**HDMI Ctrl (RIHD)**” is set to “**On**” (→ **page 35**) and you’re listening through your TV speakers, or
 - Speakers B is on, or
 - Speakers A is off.

Subwoofer

▶ Yes:

Select if a subwoofer is connected.

▶ No:

Select if no subwoofer is connected.

Front

▶ Small:

▶ Large:

Select based on the cone diameter.

Note

- If the “**Subwoofer**” setting is set to “**No**”, this setting is fixed at “**Large**” and does not appear.

Center^{*1}, Surround^{*1}

▶ Small:

▶ Large:

Select based on the cone diameter.

▶ None:

Select if no speaker is connected.

Note

- *1 If the “**Front**” setting is set to “**Small**”, the “**Large**” option cannot be selected.

Crossover (Crossover Frequency)

This setting is advantageous for the speakers that you specified as “**Small**” in the “Sp Config (Speaker Configuration)” (→ **page 31**). To get the best bass performance from your speaker system, you need to set the crossover frequency according to the size and frequency response of your speakers.

▶ **40Hz, 50Hz, 60Hz, 70Hz, 80Hz, 90Hz, 100Hz, 120Hz, 150Hz, 200Hz**

Use the diameter of the smallest speaker in your system when choosing the crossover frequency.

Speaker cone diameter	Crossover frequency
Over 8 in. (20 cm)	40/50/60 Hz*
6-1/2 to 8 in. (16 to 20 cm)	70/80/90 Hz*
5-1/4 to 6-1/2 in. (13 to 16 cm)	100 Hz
3-1/2 to 5-1/4 in. (9 to 13 cm)	120 Hz
Under 3-1/2 in. (9 cm)	150/200 Hz*

* Choose the setting suitable for the speaker.

Note

- For a more accurate setting, look up the frequency response in the manuals supplied with your speakers and set accordingly.
- Choose a higher crossover frequency if you want more sound from your subwoofer.

Double Bass

▶ On

▶ Off

Turn this setting on to boost bass output by feeding bass sounds from the front left, right, and center channels to the subwoofer.

Note

- This function can be set only if the “**Subwoofer**” setting is set to “**Yes**”, and the “**Front**” setting is set to “**Large**” (→ **page 31**).

Sp Distance (Speaker Distance)

Menu Sp Distance

Here you can specify the distance from each speaker to the listening position so that the sound from each speaker arrives at the listener’s ears as the sound designer intended.

Note

- These settings are disabled when:
 - a pair of headphones is connected, or
 - the “**Audio TV Out**” setting is set to “**On**” (→ **page 35**), or
 - “**HDMI Ctrl (RIHD)**” is set to “**On**” (→ **page 35**) and you’re listening through your TV speakers, or
 - Speakers B is on, or
 - Speakers A is off.
- Speakers that you set to “**No**” or “**None**” in the “Sp Config (Speaker Configuration)” (→ **page 31**) cannot be selected.

Unit

▶ feet:

Distances can be set in feet. Range: **1ft to 30ft** in 1 foot steps.

▶ meters:

Distances can be set in meters. Range: **0.3m to 9.0m** in 0.3 meter steps.

(The default setting varies from country to country.)

Left, Center, Right, Surround Right, Surround Left, Subwoofer

- ▶ Specify the distance from the each speaker to your listening position.

Level Cal (Level Calibration)

Menu

Level Cal

Here you can adjust the level of each speaker with the built-in test tone so that the volume of each speaker is the same at the listening position.

■ Left, Center^{*1}, Right, Surround Right, Surround Left

▶ **-12 dB** to **0 dB** to **+12 dB** in 1 dB step.

■ Subwoofer^{*1}

▶ **-15 dB** to **0 dB** to **+12 dB** in 1 dB step.

Note

- Speakers that you set to “No” or “None” in the “Sp Config (Speaker Configuration)” (→ **page 31**) cannot be selected.
- These settings cannot be calibrated in either of the following cases:
 - a pair of headphones is connected.
 - Speakers B is on.
 - Speakers A is off.
 - the “Audio TV Out” setting is set to “On” (→ **page 35**).
 - “HDMI Ctrl (RIHD)” is set to “On” (→ **page 35**) and you’re listening through your TV speakers.
 - the AV receiver is muted.

^{*1} For the center speaker and subwoofer, the level settings made by using **HOME** are saved here as the default settings.

Tip

- If you’re using a handheld sound level meter, adjust the level of each speaker so that it reads 75 dB SPL at the listening position, measured with C-weighting and slow reading.

Audio Adjust

Menu

Audio Adjust

With the Audio Adjust functions and settings, you can adjust the sound and listening modes as you like.

Multiplex/Mono Settings

■ Multiplex

Input Ch (Mux)

▶ **Main**

▶ **Sub**

▶ **Main/Sub**

This setting determines which channel of a stereo multiplex source is output. Use it to select audio channels or languages with multiplex sources, multilingual TV broadcasts, and so on.

■ Mono

Input Ch (Mono)

▶ **Left + Right**

▶ **Left**

▶ **Right**

This setting specifies the channel to be used for playing any 2-channel digital source such as Dolby Digital, or 2-channel analog/PCM source in the Mono listening mode.

Dolby Settings

■ PLII Music (2ch Input)

These settings apply to only 2-channel stereo sources.

Panorama

▶ **On**

▶ **Off**

Turn this setting on to broaden the width of the front stereo image when using the Dolby Pro Logic II Music listening mode.

Dimension

▶ **-3** to **0** to **+3**

With this setting, you can move the sound field forward or backward when using the Dolby Pro Logic II Music listening mode. Higher settings move the sound field backward. Lower settings move it forward.

If the stereo image feels too wide, or there’s too much surround sound, move the sound field forward to improve the balance. Conversely, if the stereo image feels like it’s in mono, or there’s not enough surround sound, move it backward.

Center Width

▶ **0** to **3** to **7**

With this setting, you can adjust the width of the sound from the center speaker when using the Dolby Pro Logic II Music listening mode. Normally, if you’re using a center speaker, the center channel sound is output from only the center speaker. (If you’re not using a center speaker, the center channel sound will be distributed to the front left and right speakers to create a phantom center). This setting controls the front left, right, and center mix, allowing you to adjust the weight of the center channel sound.

DTS Setting

■ Neo:6 Music

Center Image

▶ **0** to **2** to **5**

With this setting, you can specify by how much the front left and right channel output is attenuated in order to create the center channel.

Setting a value “0” in the middle is set to hear a sound. Sound is spread in left and right (the outside) so that the set value is made big. Please adjust by liking.

Theater-Dimensional Setting

■ Listening Angle

▶ **Wide:**

Select if the listening angle is 40 degrees.

▶ **Narrow:**

Select if the listening angle is 20 degrees.

With this setting, you can optimize the Theater-Dimensional listening mode by specifying the angle of the front left and right speakers relative to the listening position. Ideally, the front left and right speakers should be equidistant from the listening position and at an angle close to one of the two available settings.

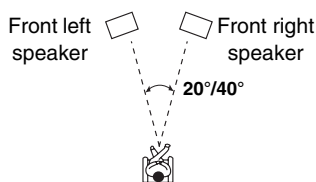

Source Setup

Menu

Source Setup

Preparation

Press the input selector buttons to select an input source.

A/V Sync

■ A/V Sync

▶ **0 ms to 400 ms** in 10 ms steps

When using progressive scanning on your Blu-ray Disc/DVD player, you may find that the picture and sound are out of sync. With this setting, you can correct this by delaying the audio signals.

To view the TV picture while setting the delay, press **ENTER**.

To return to the previous screen, press **RETURN**.

The range of values you can adjust will depend on whether your TV or display supports HDMI Lip Sync and if the “**LipSync**” setting is set to “**On**” or not (→ [page 36](#)).

Note

- A/V Sync is disabled when the Direct listening mode is used with an analog input source.

Name

■ Name

▶ **- - -**, **Blu-ray**, **DVD**, **HD DVD**, **VCR**, **DVR**, **Tivo**, **CableSTB**, **SAT STB**, **PS3**, **Wii**, **Xbox**, **PC**, **TV**, **CD**, **TAPE**, **iPod**:

To reset to the default, select “- - -”.

You can enter a preset name for each individual input selector for easy identification. When entered, the preset name will appear on the display.

Note

- Can not set the input selector by the same name.
- This menu cannot be used for the **AM**, **FM** or **USB** input selector.

Audio Selector

■ Audio Selector

▶ **ARC:**

The audio signal from your TV tuner can be sent to the **HDMI OUT** of the AV receiver.*1

With this selection the TV’s audio can be automatically selected as a priority among other assignments.

▶ **HDMI:**

This can be selected when **HDMI IN** has been assigned as an input source. If both **HDMI (HDMI IN)** and digital audio inputs (**COAXIAL IN** or **OPTICAL IN**) have been assigned, **HDMI** input is automatically selected as a priority.

▶ **COAXIAL:**

This can be selected when **COAXIAL IN** has been assigned as an input source. If both coaxial and **HDMI** inputs have been assigned, coaxial input is automatically selected as a priority.

▶ **OPTICAL:**

This can be selected when **OPTICAL IN** has been assigned as an input source. If both optical and **HDMI** inputs have been assigned, optical input is automatically selected as a priority.

▶ **Analog:**

The AV receiver always outputs analog signals.

You can set priorities of audio output when there are both digital and analog inputs.

Note

- The setting is stored individually for each input selector.
 - This setting can be made only for the input source that is assigned as **HDMI IN**, **COAXIAL IN**, or **OPTICAL IN**. If both **HDMI (HDMI IN)** and digital audio inputs (**COAXIAL IN** or **OPTICAL IN**) are assigned, **HDMI** input will be selected as a priority by setting to “**ARC**” (→ [page 35](#)). To select the digital audio input, see “Digital Audio (Digital Audio Input)” (→ [page 30](#)).
- *1 You can select “**ARC**” if you select the **TV/CD** input selector. But you cannot select it if you’ve selected “**Off**” in the “**Audio Return Ch**” setting (→ [page 35](#)).

Setting the Incoming Digital Signal (Fixed Mode)

■ Fixed Mode

▶ Off:

The format is detected automatically. If no digital input signal is present, the corresponding analog input is used instead.

▶ PCM:

Only 2-channel PCM format input signals will be heard. If the input signal is not PCM, the **PCM** indicator will flash and noise may also be produced.

▶ DTS:

Only DTS (but not DTS-HD) format input signals will be heard. If the input signal is not DTS, the **DTS** indicator will flash and there will be no sound.

When “**HDMI**”, “**COAXIAL**” or “**OPTICAL**” is selected in the “**Audio Selector**” setting, you can then specify the signal type in “**Fixed Mode**”.

Normally, the AV receiver detects the signal format automatically. However, if you experience either of the following issues when playing PCM or DTS material, you can manually set the signal format to PCM or DTS.

- If the beginnings of tracks from a PCM source are cut off, try setting the format to PCM.
- If noise is produced when fast forwarding or reversing a DTS CD, try setting the format to DTS.

Note

- The setting will be reset to “**Off**” when you change the setting in the “**Audio Selector**” (→ **page 33**).

Hardware

Menu

Hardware

OSD Setting

■ Volume OSD

▶ On

▶ Off

You can select if you wish to display the volume level on-screen, when it is adjusted.

Remote Control Settings

■ Remote ID

▶ 1, 2, or 3

When several Onkyo components are used in the same room, their remote ID codes may overlap. To differentiate the AV receiver from the other components, you can change its remote ID from “**1**”, to “**2**” or “**3**”.

Note

- If you do change the AV receiver’s remote ID, be sure to change the remote controller to the same ID (see below), otherwise, you won’t be able to control it with the remote controller.

Changing the remote controller’s ID

- 1** While holding down **RECEIVER**, press and hold down **SETUP** until the remote indicator lights (about 3 seconds) (→ **page 29**).
- 2** Use the number buttons to enter **ID 1, 2, or 3**. The remote indicator flashes twice.

Tuner

■ AM/FM Freq Step (North American and Taiwan models)

▶ 10kHz/200kHz:

▶ 9kHz/50kHz:

Select the frequency step according to your area.

■ AM Freq Step (European, Australian and Asian models)

▶ 10kHz:

▶ 9kHz:

Select the frequency step according to your area.

For AM/FM tuning to work properly, you must specify the AM/FM frequency step used in your area. Note that when this setting is changed, all radio presets will be deleted.

Auto Standby

■ Auto Standby

▶ Off

▶ On

When “**Auto Standby**” is set to “**On**”, AV receiver will automatically perform standby operation if there is no operation for 30 minutes with no audio and no video signal input.

“**Auto Standby**” will display on the display and OSD from 30 seconds before the Auto Standby functions.

Default setting: **On (European, Australian and Asian models)**, **Off (North American and Taiwan models)**

Note

- Depending on some sources, the Auto Standby function may activate during playback.

■ HDMI Ctrl (RIHD)

▶ **Off**

▶ **On**

Turn this setting on to allow **RIHD**-compatible components connected via HDMI to be controlled by the AV receiver (⇒ **page 50**).

Note

- When set to “On” and close the menu, the name of connected **RIHD**-compatible components and “RIHD On” are displayed on the AV receiver.
“Search...” → “(name)” → “RIHD On”
When the AV receiver cannot receive the name of the component, it is displayed as “Player*” or “Recorder*”, etc (“*” means the number of two or more component).
- When an **RIHD**-compatible component is connected to the AV receiver via the HDMI cable, the name of the connected component is displayed on the AV receiver display. For example, while you are watching TV broadcasting, if you operate a Blu-ray Disc/DVD player (being powered on) by the remote control of the AV receiver, the name of the Blu-ray Disc/DVD player is displayed on the AV receiver.
- Set to “Off” when a connected piece of equipment is not compatible or it is unclear whether the equipment is compatible or not.
- If movement is unnatural when set to “On”, change the setting to “Off”.
- Refer to the connected component’s instruction manual for details.
- When “HDMI Ctrl (RIHD)” setting is set to “On”, the power consumption on standby mode slightly increases. (Depending on the TV status, the AV receiver will enter standby mode as usual.)

■ HDMI Through

▶ **Off**

▶ **Auto:**

Detects the signal and automatically selects the input source.

▶ **BD/DVD, VCR/DVR, CBL/SAT, GAME, AUX, TV/CD:**

Selects the input source for which the HDMI Through function is enabled.

▶ **Last:**

The HDMI Through function is activated on the input source selected at the time of setting the AV receiver to Standby mode.

When enabling the HDMI Through function, regardless of whether the AV receiver is On or in Standby, both audio and video stream from an HDMI input will be output to the TV or other components via HDMI connection. The **HDMI THRU** and **HDMI** indicators light when enabled.

This setting is set to “Auto” automatically when the above “HDMI Ctrl (RIHD)” is set to “On”.

Note

- Only the input source assigned to the **HDMI IN** via “HDMI Input” is enabled (⇒ **page 30**).
- The power consumption during standby mode will increase during the HDMI through function; however in the following cases, the power consumption can be saved:
 - The TV is in standby mode.
 - You are watching a TV program.
- Refer to the connected component’s instruction manual for details.
- Depending on the connected component, the correct input source may not be selected with the setting set to “Auto”.
- This setting is set to “Off” automatically when the “HDMI Ctrl (RIHD)” setting is set to “Off”.

■ Audio TV Out

▶ **Off**

▶ **On**

This preference determines whether the incoming audio signal is output from the HDMI output. You may want to turn this preference on if your TV is connected to the HDMI output and you want to listen to the audio from a connected component through your TV’s speakers. Normally, this should be set to “Off”.

Note

- Listening mode cannot be changed when this setting is set to “On” and the input source is not HDMI.
- If “On” is selected and the signal can be output from the TV, the AV receiver will output no sound through its speakers. In this case, “TV Speaker” appears on the display by pressing **DISPLAY**.
- When “HDMI Ctrl (RIHD)” is set to “On”, this setting is fixed to “Auto”.
- With some TVs and input signals, no sound may be output even when this setting is set to “On”.
- When the “Audio TV Out” setting is set to “On”, or “HDMI Ctrl (RIHD)” is set to “On” and you’re listening through your TV’s speakers (⇒ **page 13**), if you turn up the AV receiver’s volume control, the sound will be output from the AV receiver’s front left and right speakers. To stop the AV receiver’s speakers producing sound, change the settings, change your TV’s settings, or turn down the AV receiver’s volume.

■ Audio Return Ch (ARC)

▶ **Off**

▶ **Auto:**

The audio signal from your TV tuner can be sent to the **HDMI OUT** of the AV receiver.

The audio return channel (ARC) function allows an ARC capable TV to send the audio stream to the **HDMI OUT** of the AV receiver. To use this function, you must select the **TV/CD** input selector and your TV must support ARC function.

Note

- If you set “Audio Return Ch” to “Auto”, the “Audio Selector” settings of the **TV/CD** input selector will be automatically switched to “ARC” (⇒ **page 33**).
- The “Audio Return Ch” setting can be set only when the above “HDMI Ctrl (RIHD)” setting is set to “On”.
- This setting is set to “Auto” automatically when the above “HDMI Ctrl (RIHD)” is set to “On” first time.

■ LipSync

- ▶ **Off**
- ▶ **On**

This function allows the AV receiver to automatically correct any delay between the video and the audio, based on the data from the connected monitor.

Note

- This function works only if your HDMI-compatible TV supports HDMI Lip Sync.

After changing the settings of the “**HDMI Ctrl (RIHD)**”, “**HDMI Through**” or “**Audio Return Ch**”, turn off the power to all connected pieces of equipment and then turn them on again. Refer to the instructions for all connected pieces of equipment.

Using the Audio Settings

You can change various audio settings from the Home menu (→ **page 26**).

- 1** Press **RECEIVER** followed by **HOME**.
- 2** Use **▲/▼** and **ENTER** to select “**Audio**”, and then use **▲/▼/◀/▶** to make the desired selection.

Note

- These settings are disabled when the “**Audio TV Out**” setting is set to “**On**” (→ **page 35**) and an input selector other than HDMI is selected.

Tone Control Settings

■ Bass

- ▶ **-10 dB** to **0 dB** to **+10 dB** in 2 dB steps
You can boost or cut low-frequency sounds output from the front speakers.

■ Treble

- ▶ **-10 dB** to **0 dB** to **+10 dB** in 2 dB steps
You can boost or cut high-frequency sounds output from the front speakers.

You can adjust the bass and treble for Speakers A and B front speakers, except when the Direct listening mode is selected.

Operating on the AV receiver

- 1** Press **TONE** on the AV receiver repeatedly to select either “**Bass**” or “**Treble**”.
- 2** Use **+** and **-** on the AV receiver to adjust.

Note

- To bypass the bass and treble tone circuits, select the Direct listening mode.

Speaker Levels

■ Subwoofer Level

- ▶ **-15 dB** to **0 dB** to **+12 dB** in 1 dB steps

■ Center Level

- ▶ **-12 dB** to **0 dB** to **+12 dB** in 1 dB steps

You can adjust the volume of each speaker while listening to an input source.

These temporary adjustments are cancelled when the AV receiver is set to Standby. To save the setting you made here, go to “**Level Cal (Level Calibration)**” (→ **page 32**) before setting the AV receiver to Standby.

Note

- You cannot use this function while the AV receiver is muted.
- Speakers that are set to “**No**” or “**None**” in the “**Sp Config (Speaker Configuration)**” (→ **page 31**) cannot be adjusted.

Late Night Function

■ Late Night

For **Dolby Digital** and **Dolby Digital Plus** sources, the options are:

- ▶ **Off**
- ▶ **Low:**
Small reduction in dynamic range.
- ▶ **High:**
Large reduction in dynamic range.

For **Dolby TrueHD** sources, the options are:

- ▶ **Auto:**
The Late Night function is set to “**On**” or “**Off**” automatically.
- ▶ **Off**
- ▶ **On**

Turn this setting on to reduce the dynamic range of Dolby Digital material so that you can still hear quiet parts even when listening at low volume levels—ideal for watching movies late at night when you don’t want to disturb anyone.

Note

- The effect of the Late Night function depends on the material that you are playing and the intention of the original sound designer, and with some material there will be little or no effect when you select the different options.
- The Late Night function can be used only when the input source is Dolby Digital, Dolby Digital Plus, or Dolby TrueHD.
- The Late Night function is set to “**Off**” when the AV receiver is set to Standby. For Dolby TrueHD sources, it will be set to “**Auto**”.

Music Optimizer

■ Music Optimizer

- ▶ Off
- ▶ **On**

Turn this setting on to enhance the sound quality of compressed music files. Use it with music files that use “lossy” compression, such as MP3.

Tip

- Alternatively, you can use the AV receiver’s **MUSIC OPTIMIZER**.

Note

- The Music Optimizer function only works with PCM digital audio input signals with a sampling rate below 48 kHz and analog audio input signals. The Music Optimizer is disabled when the Direct listening mode is selected.
- The setting is stored individually for each input selector.
- The **M.Opt** indicator will light (→ **page 8**).

CinemaFILTER

■ Cinema Filter

- ▶ Off
- ▶ **On**

Turn this setting on to soften overly bright movie soundtracks, which are typically mixed for reproduction in a movie theater.

CinemaFILTER can be used with the following listening modes: Dolby Digital, Dolby Digital Plus, Dolby TrueHD, Dolby Pro Logic II Movie, Multichannel, DTS, DTS Neo:6 Cinema, DTS 96/24, DTS-HD High Resolution Audio, DTS-HD Master Audio and DTS Express.

Note

- The CinemaFILTER may not work when used with certain input sources.

iPod/iPhone Playback via Onkyo Dock

Using the Onkyo Dock

Dock is sold separately. Models sold are different depending on the region.

For the latest information on the Onkyo Dock components, see the Onkyo web site at:

<http://www.onkyo.com>

Before using the Onkyo Dock components, update your iPod/iPhone with the latest software, available from the Apple web site.

For supported iPod/iPhone models, see the instruction manual of the Onkyo Dock.

RI Dock

With the RI Dock, you can easily play the music stored on your Apple iPod/iPhone through the AV receiver and enjoy great sound, and watch iPod/iPhone slideshows and videos on your TV. In addition, the onscreen display (OSD) allows you to view, navigate, and select your iPod/iPhone model's contents on your TV, and with the supplied remote controller, you can control your iPod/iPhone from the comfort of your sofa. You can even use the AV receiver's remote controller to operate your iPod/iPhone.

Note

- Enter the appropriate remote control code before using the AV receiver's remote controller for the first time (→ page 40).
- Connect the RI Dock to the AV receiver with an **RI** cable (→ page 15).
- Set the RI Dock's RI MODE switch to "HDD" or "HDD/DOCK".
- Set the AV receiver's Input Display to "DOCK" (→ page 27).

System Function

System On

When you turn on the AV receiver, RI Dock and iPod/iPhone turn on automatically. In addition, when RI Dock and iPod/iPhone are on, the AV receiver can be turned on by pressing ϕ .

Auto Power On

If you press the remote controller's \blacktriangleright (Playback) while the AV receiver is on Standby, the AV receiver will automatically turn on, select your iPod/iPhone as the input source, and your iPod/iPhone will start playback.

Direct Change

If you start iPod/iPhone playback while listening to another input source, the AV receiver will automatically switch to the input to which RI Dock is connected.

Other Remote Controllers

You can use the remote controller that came with the AV receiver to control other iPod/iPhone functions. The available functionality depends on the AV receiver.

iPod/iPhone Alarm

If you use the Alarm function on your iPod/iPhone to start playback, the AV receiver will turn on at the specified time and select your iPod/iPhone as the input source automatically.

Note

- Linked operations do not work with video playback or when the alarm is set to play a sound.
- If you use your iPod/iPhone with any other accessories, iPod/iPhone playback detection may not work.

Operating Notes

- Use the AV receiver's volume control to adjust the playback volume.
- While your iPod/iPhone is inserted in RI Dock, its volume control has no effect.
- If you do adjust the volume control on your iPod/iPhone while it's inserted in RI Dock, be careful that it's not set too loud before you reconnect your earphones.

Note

- On the iPod with video and iPod nano (1st generation), the click wheel is disabled during playback.

Controlling Your iPod/iPhone

By pressing **REMOTE MODE** that's been programmed with the remote control code for your Dock, you can control your iPod/iPhone in the Dock with the following buttons.

See "Remote Control Codes for Onkyo Components Connected via **RI**" for details on entering a remote control code (→ page 40).

See to the Dock's instruction manual for more information.

RI Dock

- Set the RI Dock's RI MODE switch to "HDD" or "HDD/DOCK".
- ϕ may not work with a remote control code (without **RI**). In this case, make an **RI** connection and enter a remote control code **81993** (with **RI**).

With the RI Control

In this case, make an **RI** connection and enter a remote control code **81993** (with **RI**).

- Set the AV receiver's Input Display to "DOCK" (→ page 27).

Without the RI Control

You must enter a remote control code **82990** first (→ page 40).

✓: Available buttons

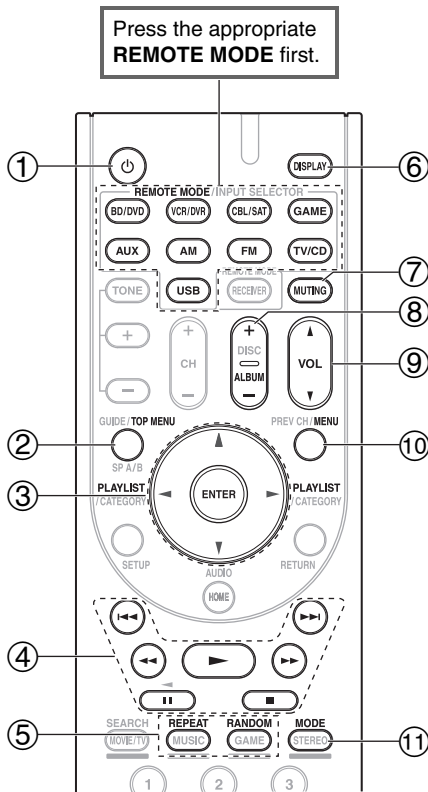

Onkyo Dock		RI Dock
Buttons		
①	⏻*1	✓
②	TOP MENU*2	✓
③	▲/▼/◀/▶, ENTER PLAYLIST ◀/▶	✓
④	▶, II, ■, ◀◀, ▶▶, ◀◀, ▶▶	✓
⑤	REPEAT RANDOM	✓
⑥	DISPLAY*3	✓
⑦	MUTING	✓
⑧	ALBUM +/-	✓
⑨	VOL ▲/▼	✓
⑩	MENU	✓
⑪	MODE*4	✓

Note

- With some iPod/iPhone models and generations, certain buttons may not work as expected.
- For detailed operation of the iPod/iPhone, please refer to the instruction manual.
- *1 This button does not turn the Onkyo DS-A2 or DS-A2X RI Dock on or off. Your iPod/iPhone may not respond the first time you press this button, in which case you should press it again.
This is because the remote controller transmits the On and Standby commands alternately, so if your iPod/iPhone is already on, it will remain on when the remote controller transmits an On command.
Similarly, if your iPod/iPhone is already off, it will remain off when the remote controller transmits an Off command.
- *2 **TOP MENU** works as a Mode button when used with a DS-A2 RI Dock.
- *3 **DISPLAY** turns on backlight for 30 seconds.
- *4 **Resume mode**
With the Resume function, you can resume playback of the song that was playing when you removed your iPod/iPhone from the RI Dock or changed the OSD mode to Off.

Controlling Other Onkyo Components

You can use the AV receiver's remote controller to control your other Onkyo AV components. This section explains how to enter the remote control code (with the default underlined) for a component that you want to control: DVD, CD, etc.

Preprogrammed Remote Control Codes

The following **REMOTE MODE** are preprogrammed with remote control codes for controlling the components listed. You do not need to enter a remote control code to control these components.

For details on controlling these components, see the pages indicated.

BD/DVD Onkyo Blu-ray Disc player (→ page 41)

TV/CD Onkyo CD player (→ page 41)

Entering Remote Control Codes

You'll need to enter a code for each component that you want to control.

- 1 Look up the appropriate remote control code in the **Remote Control Codes for Onkyo Components Connected via RI**.
- 2 While holding down **REMOTE MODE** to which you want to enter a code, press and hold down **DISPLAY** (about 3 seconds).

Note

- Remote control codes cannot be entered for **RECEIVER**.
- Apart from **RECEIVER**, remote control codes from any category can be entered for **REMOTE MODE**. However, these buttons also work as input selector buttons (→ page 18), so choose a **REMOTE MODE** that corresponds with the input to which you connect your component. For example, if you connect your CD player to the CD input, choose **TV/CD** when entering its remote control code.

- 3 Within 30 seconds, use the number buttons to enter the 5-digit remote control code.

The remote indicator flashes twice.

If the remote control code is not entered successfully, the remote indicator will flash once slowly.

Remote Control Codes for Onkyo Components Connected via RI

Onkyo components that are connected via **RI** are controlled by pointing the remote controller at the AV receiver, not the component. This allows you to control components that are out of view, in a rack, for example.

- 1 Make sure the Onkyo component is connected with an **RI** cable and an analog audio cable (RCA). See "Connecting Onkyo **RI** Components" for details (→ page 15).
- 2 Enter the appropriate remote control code for **REMOTE MODE** referring to the previous section.
 - ▶ **42157**:
Onkyo cassette tape deck with **RI**
 - ▶ **81993**:
Onkyo Dock with **RI**
- 3 Press **REMOTE MODE**, point the remote controller at the AV receiver, and operate the component.

Controlling Onkyo components without RI

If you want to control an Onkyo component by pointing the remote controller directly at it, or you want to control an Onkyo component that's not connected via **RI**, use the following remote control codes:

- ▶ **30627**:
Onkyo DVD player without **RI**
- ▶ **71817**:
Onkyo CD player without **RI**
- ▶ **32900/33000**:
Onkyo Blu-ray Disc player
- ▶ **32901/33004**:
Onkyo HD DVD player
- ▶ **70868**:
Onkyo MD recorder without **RI**
- ▶ **71323**:
Onkyo CD recorder without **RI**
- ▶ **82990**:
Onkyo Dock without **RI**

Resetting REMOTE MODE Buttons

You can reset a **REMOTE MODE** to its default remote control code.

- 1 While holding down REMOTE MODE that you want to reset, press and hold down HOME until the remote indicator lights (about 3 seconds).**
- 2 Within 30 seconds, press REMOTE MODE again.**
The remote indicator flashes twice, indicating that the button has been reset.
Each of **REMOTE MODE** is preprogrammed with a remote control code. When a button is reset, its preprogrammed code is restored.

Resetting the Remote Controller

You can reset the remote controller to its default settings.

- 1 While holding down RECEIVER, press and hold down HOME until the remote indicator lights (about 3 seconds).**
- 2 Within 30 seconds, press RECEIVER again.**
The remote indicator flashes twice, indicating that the remote controller has been reset.

Controlling Other Components

By pressing **REMOTE MODE** that's been programmed with the remote control code for your component, you can control Onkyo component as below.

For details on entering a remote control code for a different component (→ **page 40**).

Controlling a Blu-ray Disc/DVD Player, HD DVD Player

BD/DVD is preprogrammed with the remote control code for controlling a component that supports the **RIHD***1. The component must be able to receive remote control commands via **RIHD** and be connected to the AV receiver via HDMI.

Use the following remote control codes:

▶ **32910/33001/31612:**

Blu-ray Disc/DVD player with **RIHD**

*1 The **RIHD** supported by the AV receiver is the CEC system control function of the HDMI standard.

✓: Available buttons

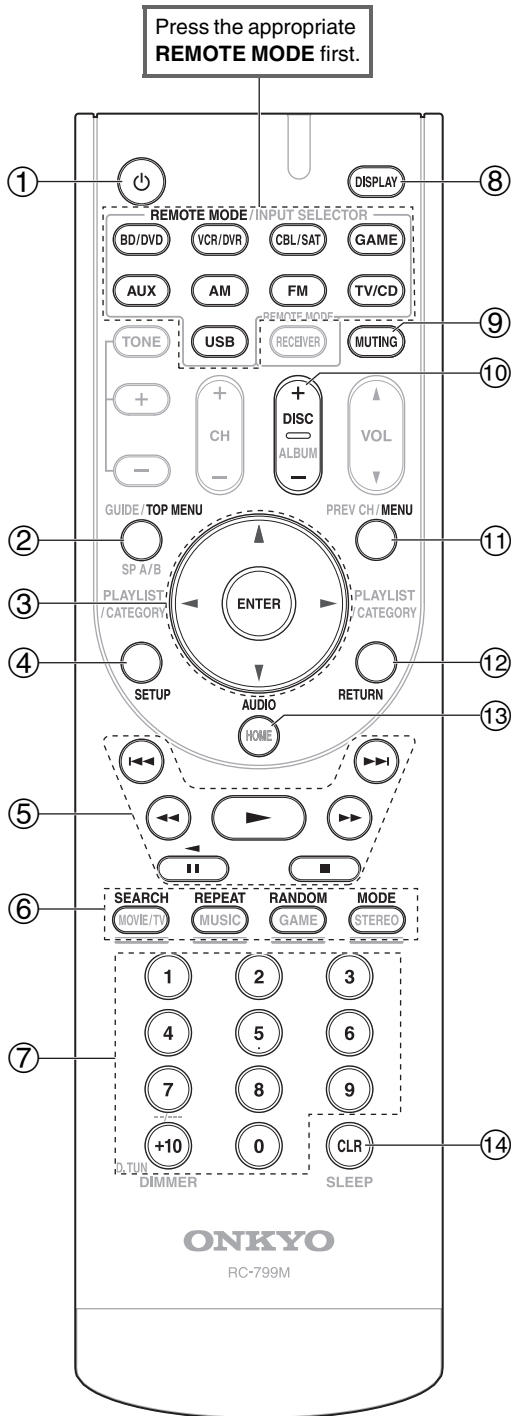

Note

- With some components, certain buttons may not work as expected, and some may not work at all.

Buttons	Components			
	DVD player	Blu-ray Disc player HD DVD player	CD player/CD recorder MD recorder	Cassette tape deck
① ⏻	✓		✓	✓
② TOP MENU	✓			
③ ▲/▼/◀/▶, ENTER	✓		✓	
④ SETUP	✓		✓	
⑤ ▶, , ■, ◀, ▶▶, ◀◀, ▶▶▶	✓		✓	✓ ³
⑥ SEARCH	✓ ¹	✓ ²	✓	
REPEAT	✓	✓ ²	✓	
RANDOM	✓ ¹	✓ ²	✓	
MODE	✓ ¹	✓ ²	✓	
⑦ Number: 1 to 9, 0	✓		✓	
Number: +10	✓ ¹		✓	
⑧ DISPLAY	✓		✓	
⑨ MUTING	✓		✓	✓
⑩ DISC +/-	✓		✓	
⑪ MENU	✓			
⑫ RETURN	✓			
⑬ AUDIO	✓ ¹			
⑭ CLR	✓		✓	

*1 The **RIHD** function is not supported. The **RIHD** supported by the AV receiver is the CEC system control function of the HDMI standard.

*2 These buttons function as colored buttons or A, B, C, D buttons.

*3 || (Pause) functions as reverse playback.

Note

- See the “Controlling Your iPod/iPhone” about the operation of iPod/iPhone (→ page 38).

Troubleshooting

If you have any trouble using the AV receiver, look for a solution in this section. If you can't resolve the issue yourself, contact your Onkyo dealer.

If you can't resolve the issue yourself, try resetting the AV receiver before contacting your Onkyo dealer.

To reset the AV receiver to its factory defaults, turn it on and, while holding down VCR/DVR, press  ON/STANDBY. "Clear" will appear on the display and the AV receiver will enter Standby mode.

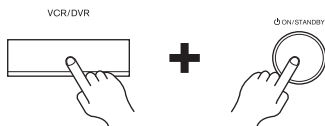

Note that resetting the AV receiver will delete your radio presets and custom settings.

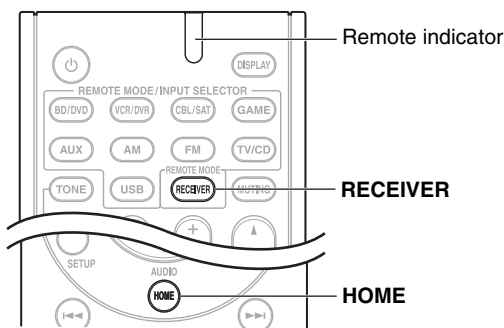

To reset the remote controller to its factory defaults, while holding down **RECEIVER**, press and hold down **HOME** until the remote indicator lights (about 3 seconds). Within 30 seconds, press **RECEIVER** again.

The on-screen setup menus appear only on a TV that is connected to the HDMI OUT. If your TV is connected to the MONITOR OUT V or the COMPONENT VIDEO OUT, use the AV receiver's display when changing settings.

Power

■ Can't turn on the AV receiver

Make sure that the power cord is properly plugged into the wall outlet. —

Unplug the power cord from the wall outlet, wait five seconds or more, then plug it in again. —

■ The AV receiver turns off unexpectedly

When the set Auto Standby starts running, the AV receiver will automatically go standby. **34**

■ When the power is restored after a power interruption, "CHECK SP WIRE" appears on the display

The protection circuitry has been activated. —
Remove the power cord from the wall outlet immediately. Disconnect all speaker cables and input sources, and then leave the AV receiver with its power cord disconnected for 1 hour. After that, reconnect the power cord and set the volume to maximum. If the AV receiver stays on, set then the volume to minimum, disconnect the power cord, and reconnect your speakers and input sources. If the AV receiver turns off when you set the volume to maximum, disconnect the power cord, and contact your Onkyo dealer.

Audio

■ There's no sound, or it's very quiet

Press **SPEAKERS A** or **B** to turn on the speaker indicator that you want to output sound. **26**

Make sure that the digital input source is selected properly. **30**

Make sure that all audio connecting plugs are pushed in all the way. **12**

Make sure that the inputs and outputs of all components are connected properly. **13-15**

Make sure that the polarity of the speaker cables is correct, and that the bare wires are in contact with the metal part of each speaker terminal. **11**

Make sure that the input source is properly selected. **18**

Make sure that the speaker cables are not shorting. **11**

Check the volume. The AV receiver is designed for home theater enjoyment. It has a wide volume range, allowing precise adjustment. **18**

If the **MUTING** indicator is flashing on the display, press the remote controller's **MUTING** to unmute the AV receiver. **28**

While a pair of headphones is connected to the **PHONES** jack, no sound is output from the speakers. **28**

If there's no sound from a DVD player connected to an HDMI IN, check the DVD player's output settings, and be sure to select a supported audio format. **49**

Check the digital audio output setting on the connected device. On some game consoles, such as those that support DVD, the default setting is off. —

With some DVD-Video discs, you need to select an audio output format from a menu. —

If your turntable uses an MC cartridge, you must connect an MC head amp, or an MC transformer. **14**

Make sure that none of the connecting cables are bent, twisted, or damaged. —

Not all listening modes use all speakers. **23**

Specify the speaker distances and adjust the individual speaker levels. **31**

The input signal format is set to "PCM" or "DTS". Set it to "Off". **34**

■ Only the front speakers produce sound

When the Stereo or Mono listening mode is selected, only the front speakers and subwoofer produce sound. **24**

Check the Speaker Configuration. **31**

■ Only the center speaker produces sound

If you use the Dolby Pro Logic II Movie, Dolby Pro Logic II Music, or Dolby Pro Logic II Game listening mode with a mono source, such as an AM radio station or mono TV program, the sound is concentrated in the center speaker. —

Make sure the speakers are configured correctly. **31**

■ The surround speakers produce no sound

When the T-D (Theater-Dimensional), Stereo or Mono listening mode is selected, the surround speakers produce no sound. **24**

Depending on the source and current listening mode, not much sound may be produced by the surround speakers. Try selecting another listening mode. **23–24**

Make sure the speakers are configured correctly. **31**

■ The center speaker produces no sound

When the Stereo or Mono listening mode is selected, the center speaker produces no sound. **24**

Make sure the speakers are configured correctly. **31**

■ The subwoofer produces no sound

The subwoofer outputs no sound while only Speakers B is on. Turn on Speakers A. **26**

When you play source material that contains no information in the LFE channel, the subwoofer produces no sound. —

Make sure the speakers are configured correctly. **31**

■ There's no sound with a certain signal format

Check the digital audio output setting on the connected device. On some game consoles, such as those that support DVD, the default setting is off. —

With some DVD-Video discs, you need to select an audio output format from a menu. —

Depending on the input signal, some listening modes cannot be selected. **23–24**

■ Can't get 5.1 playback

When Speaker B is turned on, Speakers A is reduced to 2.1 channel playback. **26**

You can not always select all of the listening modes, depending on the number of the speakers connected. **23–24**

■ The speaker volume cannot be set as required

After the volume level of each individual speaker has been adjusted, the maximum volume may be reduced. **32**

■ Noise can be heard

Using cable ties to bundle audio cables with power cords, speaker cables, and so on may degrade the audio performance, so don't do it. —

An audio cable may be picking up interference. Try repositioning your cables. —

■ The Late Night function doesn't work

Make sure the source material is Dolby Digital, Dolby Digital Plus, or Dolby TrueHD. **36**

■ About DTS signals

When DTS program material ends and the DTS bitstream stops, the AV receiver remains in DTS listening mode and the DTS indicator remains on. This is to prevent noise when you use the pause, fast forward, or fast reverse function on your player. If you switch your player from DTS to PCM, because the AV receiver does not switch formats immediately, you may not hear any sound, in which case you should stop your player for about three seconds, and then resume playback. —

With some CD and LD players, you won't be able to playback DTS material properly even though your player is connected to a digital input on the AV receiver. This is usually because the DTS bitstream has been processed (e.g., output level, sampling rate, or frequency response changed) and the AV receiver doesn't recognize it as a genuine DTS signal. In such cases, you may hear noise. —

When playing DTS program material, using the pause, fast forward, or fast reverse function on your player may produce a short audible noise. This is not a malfunction. —

■ The beginning of audio received by an HDMI IN can't be heard

Since it takes longer to identify the format of an HDMI signal than it does for other digital audio signals, audio output may not start immediately. —

Video

■ There's no picture

Make sure that all video connecting plugs are pushed in all the way. **12**

Make sure that each video component is properly connected. **13, 15**

If the video source is connected to a component video input, you must assign that input to an input selector, and your TV must be connected to **COMPONENT VIDEO OUT**. **14, 30**

If the video source is connected to a composite video input, your TV must be connected to the corresponding composite video output. **14**

If the video source is connected to an HDMI input, you must assign that input to an input selector, and your TV must be connected to the **HDMI OUT**. **13, 30**

On your TV, make sure that the video input to which the AV receiver is connected is selected. —

■ There's no picture from a source connected to an HDMI IN

Reliable operation with an HDMI-to-DVI adapter is not guaranteed. In addition, video signals from a PC are not guaranteed. **50**

■ The on-screen menus don't appear

On your TV, make sure that the video input to which the AV receiver is connected is selected. —

When the AV receiver doesn't connect TV with HDMI, onscreen menus are not displayed. —

Tuner

■ Reception is noisy, FM stereo reception is noisy, or the FM STEREO indicator doesn't light

Relocate your antenna. —

Move the AV receiver away from your TV or computer. —

Listen to the station in mono. 21

When listening to an AM station, operating the remote controller may cause noise. —

Passing cars and airplanes can cause interference. —

Concrete walls weaken radio signals. —

If nothing improves the reception, install an outdoor antenna. —

Remote Controller

■ The remote controller doesn't work

Before operating this unit, be sure to press **RECEIVER**. —

Make sure that the batteries are installed with the correct polarity. 4

Install new batteries. Don't mix different types of batteries, or old and new batteries. 4

Make sure that the remote controller is not too far away from the AV receiver, and that there's no obstruction between the remote controller and the AV receiver's remote control sensor. 4

Make sure that the AV receiver is not subjected to direct sunshine or inverter-type fluorescent lights. Relocate if necessary. —

If the AV receiver is installed in a rack or cabinet with colored-glass doors, the remote controller may not work reliably when the doors are closed. —

Make sure you've selected the correct remote controller mode. 9, 41

Make sure you've entered the correct remote control code. 40

Make sure to set the same ID on both the AV receiver and remote controller. 34

■ Can't control other components

If it's an Onkyo component, make sure that the **RI** cable and analog audio cable are connected properly. Connecting only an **RI** cable won't work. 15

Make sure you've selected the correct remote controller mode. 9, 41

If you've connected a cassette tape deck, to the **TV/CD IN** jack, or an **RI Dock** to the **TV/CD IN** or **GAME IN** or **VCR/DVR IN** jacks, for the remote controller to work properly, you must set the display. 27

If you cannot operate it, you will need to enter the appropriate remote control code. 40

To control an Onkyo component that's connected via **RI**, point the remote controller at the AV receiver. Be sure to enter the appropriate remote control code first. 40

To control an Onkyo component that's not connected via **RI** point the remote controller at the component. Be sure to enter the appropriate remote control code first. 40

Recording

■ Can't record

On your recorder, make sure the correct input is selected. —

To prevent signal loops and damage to the AV receiver, input signals are not fed through to outputs with the same name (e.g., **VCR/DVR IN** to **VCR/DVR OUT**). —

USB Device Playback

■ Can't access the music files on a USB device

Make sure the USB device is plugged in properly. —

The AV receiver supports USB devices that support the USB mass storage device class. However, playback may not be possible with some USB devices even if they conform to the USB mass storage device class. 48

USB memory devices with security functions cannot be played. 20

Others

■ Standby power consumption

In the following cases, the power consumption may reach up to a maximum of 31 W: 35

- “**HDMI Ctrl (RIHD)**” setting is set to “**On**”.
- (Depending on the TV status, the AV receiver will enter Standby mode as usual.)

■ The sound changes when I connect my headphones

When a pair of headphones is connected, the listening mode is set to Stereo, unless it's already set to Stereo, Mono, or Direct. —

■ How do I change the language of a multiplex source

Use the “**Input Ch (Mux)**” setting on the “**Audio Adjust**” menu to select “**Main**” or “**Sub**”. 32

■ The **RI** functions don't work

To use **RI**, you must make an **RI** connection and an analog audio connection (RCA) between the component and AV receiver, even if they are connected digitally. 15

■ **The following settings can be made for the composite video inputs**

You must use the buttons on the unit to make these settings.

On the AV receiver, press the input selector for the input source that you want to set and the **SETUP** button simultaneously. While holding down the input selector button, press **SETUP** until “**Video ATT:ON**” appears on the display. Then, release both buttons. To reactivate the setting, repeat the above process so that “**Video ATT:OFF**” appears on the display, and release the buttons.

• **Video Attenuation**

This setting can be made for the **BD/DVD, VCR/DVR, CBL/SAT, GAME, or AUX** input.

If you have a games console connected to the composite video input, and the picture isn't very clear, you can attenuate the gain.

Video ATT:OFF: (default).

Video ATT:ON: Gain is reduced by 2 dB.

■ **If the picture on your TV/monitor connected to HDMI OUT is unstable, try switching the DeepColor function off**

To turn off the DeepColor function, simultaneously press the **CBL/SAT** and **ON/STANDBY** buttons on the AV receiver. While holding down **CBL/SAT**, press **ON/STANDBY** until “**Off**” appears on the display. Then, release both buttons. To reactivate the DeepColor function, repeat the above process until “**On**” appears on the display and release the buttons.

The AV receiver contains a microcomputer for signal processing and control functions. In very rare situations, severe interference, noise from an external source, or static electricity may cause it to lockup. In the unlikely event that this happens, unplug the power cord from the wall outlet, wait at least five seconds, and then plug it back in again.

Onkyo is not responsible for damages (such as CD rental fees) due to unsuccessful recordings caused by the unit's malfunction. Before you record important data, make sure that the material will be recorded correctly.

Before disconnecting the power cord from the wall outlet, set the AV receiver to Standby.

Connection Tips and Video Signal Path

The AV receiver supports several connection formats for compatibility with a wide range of AV equipment. The format you choose will depend on the formats supported by your components. Use the following sections as a guide.

The on-screen setup menus appear only on a TV that is connected to the HDMI OUT. If your TV is connected to the MONITOR OUT V or the COMPONENT VIDEO OUT, use the AV receiver's display when changing settings.

Note

- The on-screen setup menus are displayed when:
 - There is no video input, or
 - The video input is 480p, 576p, 720p, 1080i, or 1080p.

Video Connection Formats

Video component can be connected by using any one of the following video connection formats: composite video, component video, or HDMI, the latter offering the best picture quality.

When choosing a connection format, bear in mind that the AV receiver doesn't convert between formats, so only outputs of the same format as the input will output the signal.

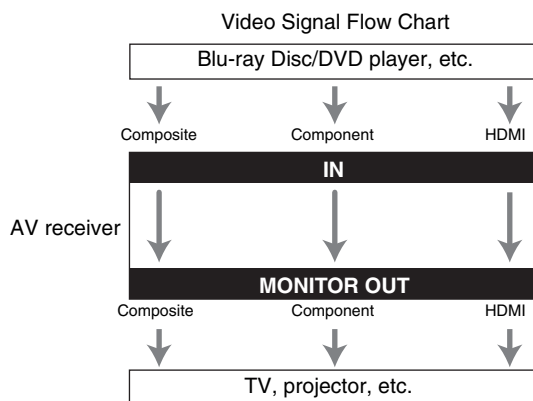

Audio Connection Formats

Audio component can be connected by using any of the following audio connection formats: analog, optical, coaxial, or HDMI.

When choosing a connection format, bear in mind that the AV receiver does not convert digital input signals for analog line outputs and vice versa. For example, audio signals connected to an optical or coaxial digital input are not output by the analog **VCR/DVR OUT**.

If signals are present at more than one input, the inputs will be selected automatically in the following order of priority: HDMI, digital, analog.

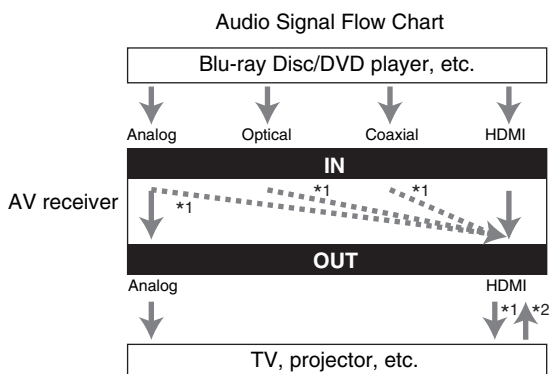

*1 Depends on the "Audio TV Out" setting (→ page 35).

*2 This setting is available, when "Audio Return Ch" setting is set to "Auto" (→ page 35), you must select the TV/CD input selector and your TV must support ARC function.

USB Features

USB Device Requirements

- USB mass storage device class (but not always guaranteed).
- FAT16 or FAT32 file system format.
- Each folder may contain up to 255 music files and folders, and folders may be nested up to 8 levels deep.
- USB hubs and USB devices with hub functions are not supported.

Supported Audio File Formats

For and playback from a USB device, the AV receiver supports the following music file formats.

Variable bit-rate (VBR) files are supported. (Playing times may not display correctly.)

■ **MP3 (.mp3 or .MP3)**

- MP3 files must be MPEG-1/MPEG-2.5 Audio Layer 3 format with a sampling rate of 8 kHz, 11.025 kHz, 12 kHz, 16 kHz, 22.05 kHz, 24 kHz, 32 kHz, 44.1 kHz, 48 kHz and a bit-rate of between 8 kbps and 320 kbps. Incompatible files cannot be played.

■ **WMA (.wma or .WMA)**

WMA stands for Windows Media Audio and is an audio compression technology developed by Microsoft Corporation. Audio can be encoded in WMA format by using Windows Media® Player.

- WMA files must have the copyright option turned off.
- Sampling rates of 32 kHz, 44.1 kHz, 48 kHz and bitrates of between 48 kbps and 320 kbps are supported.
- WMA DRM/Pro/Voice formats are not supported.

■ **AAC (.aac/.m4a/.mp4/.3gp/.3g2/.AAC/.M4A/.MP4/.3GP or .3G2)**

AAC stands for MPEG-2/MPEG-4 Audio.

- Sampling rates of 16 kHz, 22.05 kHz, 24 kHz, 32 kHz, 44.1 kHz, 48 kHz and bitrates of between 8 and 320 kbps, are supported.

■ **FLAC (.flac or .FLAC)**

FLAC is a file format for lossless audio data compression.

- Sampling rates of 32 kHz, 44.1 kHz and 48 kHz are supported.
- Quantization bit: 16 bit, 24 bit

About HDMI

Designed to meet the increased demands of digital TV, HDMI (High Definition Multimedia Interface) is a new digital interface standard for connecting TVs, projectors, Blu-ray Disc/DVD players, set-top boxes, and other video components. Until now, several separate video and audio cables have been required to connect AV components. With HDMI, a single cable can carry control signals, digital video, and up to eight channels of digital audio (2-channel PCM, multichannel digital audio, and multichannel PCM).

The HDMI video stream (i.e., video signal) is compatible with DVI (Digital Visual Interface)*1, so TVs and displays with a DVI input can be connected by using an HDMI-to-DVI adapter cable. (This may not work with some TVs and displays, resulting in no picture.)

The AV receiver uses HDCP (High-bandwidth Digital Content Protection)*2, so only HDCP-compatible components can display the picture.

The AV receiver's HDMI interface is based on the following:

Audio Return Channel, 3D, x.v.Color, Deep Color, Lip Sync, DTS-HD Master Audio, DTS-HD High Resolution Audio, Dolby TrueHD, Dolby Digital Plus, DSD and Multichannel PCM

Supported Audio Formats

- 2-channel linear PCM (32–192 kHz, 16/20/24 bit)
- Multichannel linear PCM (up to 7.1 ch, 32–192 kHz, 16/20/24 bit)
- Bitstream (DSD, Dolby Digital, Dolby Digital Plus, Dolby TrueHD, DTS, DTS-HD High Resolution Audio, DTS-HD Master Audio)

Your Blu-ray Disc/DVD player must also support HDMI output of the above audio formats.

About Copyright Protection

The AV receiver supports HDCP (High-bandwidth Digital Content Protection)*2, a copy-protection system for digital video signals. Other devices connected to the AV receiver via HDMI must also support HDCP.

*1 DVI (Digital Visual Interface): The digital display interface standard set by the DDWG*3 in 1999.

*2 HDCP (High-bandwidth Digital Content Protection): The video encryption technology developed by Intel for HDMI/DVI. It's designed to protect video content and requires a HDCP-compatible device to display the encrypted video.

*3 DDWG (Digital Display Working Group): Lead by Intel, Compaq, Fujitsu, Hewlett Packard, IBM, NEC, and Silicon Image, this open industry group's objective is to address the industry's requirements for a digital connectivity specification for high-performance PCs and digital displays.

Note

- The HDMI video stream is compatible with DVI (Digital Visual Interface), so TVs and displays with a DVI input can be connected by using an HDMI-to-DVI adapter cable. (Note that DVI connections only carry video, so you'll need to make a separate connection for audio.) However, reliable operation with such an adapter is not guaranteed. In addition, video signals from a PC are not supported.
- The HDMI audio signal (sampling rate, bit length, etc.) may be restricted by the connected source component. If the picture is poor or there's no sound from a component connected via HDMI, check its setup. Refer to the connected component's instruction manual for details.

Using an RIHD-compatible TV, Player, or Recorder

RIHD, which stands for Remote Interactive over HDMI, is the name of the system control function found on Onkyo components. The AV receiver can be used with CEC (Consumer Electronics Control), which allows system control over HDMI and is part of the HDMI standard. CEC provides interoperability between various components, however, operation with components other than **RIHD**-compatible components cannot be guaranteed.

About RIHD-compatible components

The following components are **RIHD**-compatible. (As of January 2011)

■ TV

- Toshiba REGZA-LINK compatible TV
- Sharp TV

■ Players/Recorders

- Onkyo and Integra **RIHD**-compatible players
- Toshiba REGZA-LINK compatible players and recorders (only when used together with Toshiba REGZA-LINK compatible TV)
- Sharp players and recorders (only when used together with Sharp TV)

* Models other than those mentioned above may have some interoperability if compatible with CEC which is part of the HDMI Standard, but operation cannot be guaranteed.

Note

- Do not connect the **RIHD**-compatible component more than the following number to the HDMI input terminal so that the linked operations work properly.
 - Blu-ray Disc/DVD player is up to three.
 - Blu-ray Disc recorder/DVD recorder/Digital Video Recorder is up to three.
 - Cable/Satellite Set-top box is up to four.
- Do not connect the AV receiver to the other AV receiver/AV amplifier via HDMI.
- When the **RIHD**-compatible component more than the above-mentioned is connected, the linked operations are not guaranteed.

Operations that can be performed with RIHD connection

■ For RIHD-compatible TV

The following linked operation is possible by connecting the AV receiver to an **RIHD**-compatible TV.

- The AV receiver will enter Standby mode when the power of the TV is turned to Standby.
- You can set on the menu screen of the TV to either output the audio from the speakers connected to the AV receiver, or from the speakers of the TV.
- It is possible to output the video/audio from the antenna or from the input jack of the TV from the speakers connected to the AV receiver. (A connection such as optical digital cable or similar is required above the HDMI cable.)
- Input to the AV receiver can be selected with the remote controller of the TV.
- Operations such as volume adjustment or similar for the AV receiver can be performed from the remote controller of the TV.

■ For RIHD-compatible players/recorders

The following link operation is possible by connecting the AV receiver to an **RIHD**-compatible player/recorder.

- When the playback is started on the player/recorder, input of the AV receiver will switch to the HDMI input of the player/recorder that is playing back.
- Operation of the player/recorder is possible with the remote controller supplied with the AV receiver.

* Not all functions may operate depending on the model.

■ How to connect and setup

1 Confirm the connecting and setting.

1. Connect the **HDMI OUT** jack to the HDMI input jack of the TV.

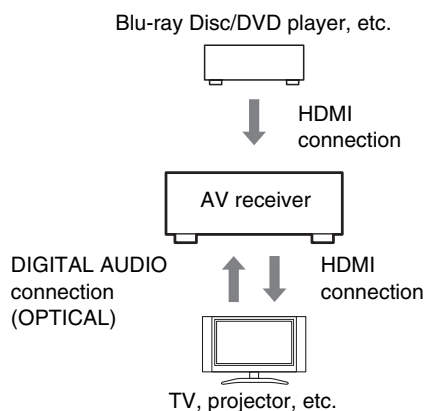

2. Connect the audio output from the TV to the **OPTICAL IN 2** jack of the AV receiver using an optical digital cable.

Note

- When the audio return channel (ARC) function is used with an ARC capable TV, this connection is not necessary (→ [page 35](#)).
3. Connect the HDMI output of the Blu-ray Disc/DVD player/recorder to the **HDMI IN 1** jack of the AV receiver.

Note

- It is necessary to assign the HDMI input when connecting the Blu-ray Disc/DVD player/recorder to other jacks (→ [page 30](#)). Do not assign the components connected to the HDMI IN to the TV/CD input at this time. Appropriate CEC (Consumer Electronics Control) operation can not be guaranteed.

2 Each of the “HDMI Setup” is changed to the following setting.

- **HDMI Ctrl (RIHD): On**
- **Audio Return Ch (ARC): Auto**

See details of each setting (→ [page 35](#)).

3 Confirm the settings.

1. Turn on the power for all connected components.
2. Turn off the power of the TV, and confirm that the power of the connected components is turned off automatically with the link operation.
3. Turn on the power of the Blu-ray Disc/DVD player/recorder.
4. Start playback of the Blu-ray Disc/DVD player/recorder, and confirm the following.
 - The power of the AV receiver is turned on automatically, and input with the Blu-ray Disc/DVD player/recorder connected is selected.
 - The power of the TV is turned on automatically, and input with the AV receiver connected is selected.
5. Following the operating instructions of the TV, select “Use the TV speakers” from the menu screen of the TV, and confirm that the audio is output from the speakers of the TV, and not from the speakers connected to the AV receiver.
6. Select “Use the speakers connected from the AV receiver” from the menu screen of the TV, and confirm that the audio is output from the speakers connected to the AV receiver, and not from the TV speakers.

Note

- Perform the above operations when you initially use the AV receiver, when the settings of each component are changed, when the main power of each component is turned off, when the power cable is disconnected from the power supply, or when there has been a power outage.

4 Operate with the remote controller.

For buttons that can be operated (→ [page 40](#)).

Note

- Audio from DVD-Audio or Super Audio CD may not output from the TV speakers. You will be able to output the audio from the TV speakers by setting the audio output of the DVD player to 2ch PCM. (It may not be possible depending on the player models.)
- Even if you set to output audio on the TV speakers, audio will be output from the speakers connected to the AV receiver when you adjust the volume or switch the input on the AV receiver. To output audio from the TV speakers, redo the operations on the TV.
- Do not connect the **RI** cable when connecting to the **RI** and **RI** audio control compatible components.
- When you select anything other than the HDMI jack where the AV receiver is connected as the input on the TV, input on the AV receiver will be switched to “TV/CD”.
- The AV receiver will automatically power on in conjunction when it determines it to be necessary. Even if the AV receiver is connected to an **RIHD** compatible TV or player/recorder, it will not power on if it is not necessary. It may not power on in conjunction when the TV is set to output audio from the TV.
- Linked functions with the AV receiver may not work depending on the model. Operate the AV receiver directly in such cases.

Specifications

Amplifier Section

Rated Output Power

All channels: (North American)
65 watts minimum continuous power per channel, 8 ohm loads, 2 channels driven from 20 Hz to 20 kHz, with a maximum total harmonic distortion of 0.7% (FTC)
90 watts minimum continuous power per channel, 6 ohm loads, 2 channels driven at 1 kHz, with a maximum total harmonic distortion of 0.9% (FTC)

(Others)

1 ch × 100 W at 6 ohms, 1 kHz,
1 ch driven of 1% (IEC)

Maximum Effective Output Power

(Australian and Asian)

1 ch × 120 W at 6 ohms, 1 kHz, 1 ch driven (JEITA)

Dynamic Power*

* IEC60268-Short-term maximum output power

160 W (3 Ω, Front)
125 W (4 Ω, Front)
85 W (8 Ω, Front)

THD+N (Total Harmonic Distortion+Noise)

0.08% (20 Hz - 20 kHz, half power)

Damping Factor

60 (Front, 1 kHz, 8 Ω)

Input Sensitivity and Impedance (Unbalance)

200 mV/47 kΩ (LINE)

Rated RCA Output Level and Impedance

200 mV/2.2 kΩ (REC OUT)

Maximum RCA Output Level and Impedance

2 V/2.2 kΩ (REC OUT)

Frequency Response

20 Hz - 50 kHz/+1 dB, -3 dB (DSP bypass)

Tone Control Characteristics

±10 dB, 50 Hz (BASS)
±10 dB, 20 kHz (TREBLE)

Signal to Noise Ratio

100 dB (LINE, IHF-A)

Speaker Impedance

6 Ω - 16 Ω

Video Section

Input Sensitivity/Output Level and Impedance

1 V_{p-p}/75 Ω (Component Y)
0.7 V_{p-p}/75 Ω (Component P_B/C_B, P_R/C_R)
1 V_{p-p}/75 Ω (Composite)

Component Video Frequency Response

5 Hz - 100 MHz/+0 dB, -3 dB

Tuner Section

FM Tuning Frequency Range

(North American)
87.5 MHz - 107.9 MHz
(Taiwan)
87.5 MHz - 108.0 MHz
(Others)
87.5 MHz - 108.0 MHz, RDS

AM Tuning Frequency Range

522/530 kHz - 1611/1710 kHz

Preset Channel

40

General

Power Supply

(North American and Taiwan)
AC 120 V, 60 Hz
(European) AC 230 V, 50 Hz
(Others) AC 220 - 240 V, 50/60 Hz

Power Consumption

(North American) 3.3 A
(European) 300 W
(Others) 330 W

Stand-by Power Consumption

(North American and Taiwan) 0.2 W
(Others) 0.3 W

Dimensions

(W × H × D)

435 mm × 150 mm × 328 mm
17-1/8" × 5-7/8" × 12-15/16"

Weight

7.5 kg (16.5 lbs.)

■ HDMI

Input

IN 1, IN 2, IN 3

Output

OUT

Video Resolution

1080p

Audio Format

Dolby TrueHD, DTS Master Audio,
DVD-Audio, DSD

Supported

3D, Audio Return Channel, DeepColor,
x.v.Color, LipSync, CEC (RIHD)

■ Video Inputs

Component

IN 1, IN 2

Composite

BD/DVD, VCR/DVR, CBL/SAT, GAME,
AUX

■ Video Outputs

Component

OUT

Composite

MONITOR OUT, VCR/DVR OUT

■ Audio Inputs

Digital

Optical: 2
Coaxial: 1

Analog

BD/DVD, VCR/DVR, CBL/SAT, GAME,
TV/CD, AUX

■ Audio Outputs

Analog

VCR/DVR

Subwoofer Pre Output

1

Speaker Outputs

SP-A (L, R, C, SL, SR) + SP-B (L, R)

Phones

1 (6.3 ϕ)

■ Others

USB

1 (Front)

RI

1

Specifications and features are subject to change without notice.

Memo

Memo



Memo

ONKYO®

ONKYO SOUND & VISION CORPORATION

2-1, Nisshin-cho, Neyagawa-shi, OSAKA 572-8540, JAPAN
Tel: 072-831-8023 Fax: 072-831-8163

ONKYO U.S.A. CORPORATION

18 Park Way, Upper Saddle River, N.J. 07458, U.S.A.
Tel: 800-229-1687, 201-785-2600 Fax: 201-785-2650
<http://www.us.onkyo.com/>

ONKYO EUROPE ELECTRONICS GmbH

Liegnitzerstrasse 6, 82194 Groebenzell, GERMANY
Tel: +49-8142-4401-0 Fax: +49-8142-4401-555
<http://www.eu.onkyo.com/>

ONKYO EUROPE ELECTRONICS GmbH (UK BRANCH)

The Coach House 81A High Street, Marlow, Buckinghamshire, SL7 1AB, UK
Tel: +44-(0)1628-473-350 Fax: +44-(0)1628-401-700

ONKYO CHINA LIMITED

Unit 1 & 12, 9/F, Ever Gain Plaza Tower 1, 88, Container Port Road, Kwai Chung,
N.T., Hong Kong. Tel: 852-2429-3118 Fax: 852-2428-9039
<http://www.ch.onkyo.com/>

SN 29400557

(C) Copyright 2010 ONKYO SOUND & VISION CORPORATION Japan. All rights reserved.

Y1012-1



* 2 9 4 0 0 5 5 7 *