



HEAVY DUTY HOT KNIFE

Model 66182

SET UP AND OPERATING INSTRUCTIONS



Distributed exclusively by Harbor Freight Tools®.

3491 Mission Oaks Blvd., Camarillo, CA 93011

Visit our website at: <http://www.harborfreight.com>



**Read this material before using this product.
Failure to do so can result in serious injury.
SAVE THIS MANUAL.**

Copyright© 2008 by Harbor Freight Tools®. All rights reserved. No portion of this manual or any artwork contained herein may be reproduced in any shape or form without the express written consent of Harbor Freight Tools. Diagrams within this manual may not be drawn proportionally. Due to continuing improvements, actual product may differ slightly from the product described herein. Tools required for assembly and service may not be included.

For technical questions or replacement parts, please call 1-800-444-3353.

SAVE THIS MANUAL

Keep this manual for the safety warnings and precautions, assembly, operating, inspection, maintenance and cleaning procedures. Write the product's serial number in the back of the manual (or month and year of purchase if product has no number). Keep this manual and the receipt in a safe and dry place for future reference.

IMPORTANT SAFETY INFORMATION

In this manual, on the labeling, and all other information provided with this product:



This is the safety alert symbol. It is used to alert you to potential personal injury hazards. Obey all safety messages that follow this symbol to avoid possible injury or death.

DANGER

DANGER indicates a hazardous situation which, if not avoided, will result in death or serious injury.

WARNING

WARNING indicates a hazardous situation which, if not avoided, could result in death or serious injury.

CAUTION

CAUTION, used with the safety alert symbol, indicates a hazardous situation which, if not avoided, could result in minor or moderate injury.

NOTICE

NOTICE is used to address practices not related to personal injury.

CAUTION

CAUTION, without the safety alert symbol, is used to address practices not related to personal injury.

General Safety Warnings



WARNING! Read all safety warnings and instructions. *Failure to follow the warnings and instructions may result in electric shock, fire and/or serious injury. Save all warnings and instructions for future reference. The term "power tool" in the warnings refers to your line-operated (corded) power tool.*

1. **Work area safety**
 - a. **Keep work area clean and well lit.** *Cluttered or dark areas invite accidents.*
 - b. **Do not operate power tools in explosive atmospheres, such as in the presence of flammable liquids, gases or dust.** *Power tools create sparks which may ignite the dust or fumes.*
 - c. **Keep children and bystanders away while operating a power tool.** *Distractions can cause you to lose control.*
2. **Electrical safety**
 - a. **Power tool plugs must match the outlet. Never modify the Power Plug in any way. Do not use any adapter plugs with grounded power tools.** *Unmodified plugs and*

matching outlets will reduce risk of electric shock.

- b. Avoid body contact with grounded surfaces such as pipes, radiators, ranges and refrigerators.** *There is an increased risk of electric shock if your body is grounded.*
 - c. Do not expose power tools to rain or wet conditions.** *Water entering a power tool will increase the risk of electric shock.*
 - d. Do not abuse the Power Cord.** **Never use the Cord for carrying, pulling or unplugging the power tool. Keep the Cord away from heat, oil, sharp edges or moving parts.** *Damaged or entangled cords increase the risk of electric shock.*
 - e. When operating a power tool outdoors, use an Extension Cord (not included) suitable for outdoor use.** *Use of a cord suitable for outdoor use reduces the risk of electric shock.*
 - f. If operating a power tool in a damp location is unavoidable, use a Ground Fault Circuit Interrupter (GFCI) protected supply.** *Use of a GFCI reduces the risk of electric shock.*
- 3. Personal safety**
 - a. Stay alert, watch what you are doing and use common sense when operating a power tool. Do not use a power tool while you are tired or under the influence of drugs, alcohol or medication.** *A moment of inattention while operating power tools may result in serious personal injury.*
 - b. Use personal protective equipment. Always wear ANSI-approved safety goggles.** *Safety equipment such as NIOSH-approved dust mask/respirator, non-skid safety shoes, hard hat, or hearing protection used for appropriate conditions will reduce personal injuries.*
 - c. Prevent unintentional starting.** **Ensure the Power Switch is in the off-position before connecting to power source and/or picking up or carrying the tool.** *Carrying power tools with your finger on the Switch or energizing power tools that have the Switch on invites accidents.*
 - d. Remove any adjusting key or wrench before turning the power tool on.** *A wrench or a key left attached to a rotating part of the power tool may result in personal injury.*
 - e. Do not overreach. Keep proper footing and balance at all times.** *This enables better control of the power tool in unexpected situations.*
 - f. Dress properly. Do not wear loose clothing or jewelry. Keep your hair, clothing and gloves away from moving parts.** *Loose clothes, jewelry or long hair can be caught in moving parts.*
 - g. Only use safety equipment that has been approved by an appropriate standards agency.** *Unapproved safety equipment may not provide adequate protection. Eye protection must be ANSI-approved and breathing protection must be NIOSH-approved for the specific hazards in the work area.*
- 4. Power tool use and care**
 - a. Do not force the power tool. Use the correct power tool for your application.** *The correct power tool will*

do the job better and safer at the rate for which it was designed.

- b. Do not use the power tool if the Power Switch does not turn it on and off.** *Any power tool that cannot be controlled with the Switch is dangerous and must be repaired.*
 - c. Disconnect the Power Plug from the power source before making any adjustments, changing accessories, or storing power tools.** *Such preventive safety measures reduce the risk of starting the power tool accidentally.*
 - d. Store idle power tools out of the reach of children and do not allow persons unfamiliar with the power tool or these instructions to operate the power tool.** *Power tools are dangerous in the hands of untrained users.*
 - e. Maintain power tools. Check for misalignment or binding of moving parts, breakage of parts and any other condition that may affect the power tool's operation. If damaged, have the power tool repaired before use.** *Many accidents are caused by poorly maintained power tools.*
 - f. Use the power tool and its accessories in accordance with these instructions, taking into account the working conditions and the work to be performed.** *Use of the power tool for operations different from those intended could result in a hazardous situation.*
- 5. Service**
- a. Have your power tool serviced by a qualified repair person using only identical replacement parts.**

This will ensure that the safety of the power tool is maintained.

Specific Safety Warnings

1. Maintain labels and nameplates on the Hot Knife. These carry important safety information. If unreadable or missing, contact Harbor Freight Tools for a replacement.
2. This Hot Knife can create heat up to approximately 840° Fahrenheit. Always keep fingers, hands, body, and clothing away from the heated components of this tool.
3. Avoid unintentional starting. Prepare to begin work before turning on the Hot Knife.
4. Do not allow any objects (liquid or metal) to fall into the Heat Block holes of the tool. Doing so can cause short circuiting and/or electric shock.
5. Do not lay the Hot Knife down on a flammable surface. Use and lay this tool on a fireproof work surface only.
6. Always keep multiple class ABC fire extinguishers nearby.
7. Use the Hot Knife in a well ventilated area only.
8. Do not leave the Hot Knife unattended when it is plugged into an electrical outlet. Turn off the tool, and unplug it from its electrical outlet before leaving.
9. Allow the Hot Knife to completely cool before storing.
10. This product is not a toy. Keep it out of reach of children.

11. People with pacemakers should consult their physician(s) before use. Electromagnetic fields in close proximity to heart pacemaker could cause pacemaker interference or pacemaker failure. In addition, people with pacemakers should:
 - Avoid operating alone.
 - Do not use with Power Switch (19) locked on.
 - Properly maintain and inspect to avoid electrical shock.
 - Any Power Cord (21) must be properly grounded. Ground Fault Circuit Interrupter (GFCI) should also be implemented – it prevents sustained electrical shock.

12. **WARNING:** Handling the Power Cord (21) on this product will expose you to lead, a chemical known to the State of California to cause cancer, and birth defects or other reproductive harm. Wash hands after handling. (California Health & Safety Code § 25249.5, et seq.)

13. The warnings, precautions, and instructions discussed in this instruction manual cannot cover all possible conditions and situations that may occur. It must be understood by the operator that common sense and caution are factors which cannot be built into this product, but must be supplied by the operator.



SAVE THESE INSTRUCTIONS.

GROUNDING

⚠ WARNING TO PREVENT ELECTRIC SHOCK



AND DEATH FROM INCORRECT GROUNDING WIRE CONNECTION:

Check with a qualified electrician if you are in doubt as to whether the Outlet is properly grounded. Do not modify the Power Cord Plug (21) provided with the tool. Never remove the grounding prong from the Plug. Do not use the tool if the Power Cord or Plug is damaged. If damaged, have it repaired by a service facility before use. If the Plug will not fit the Outlet, have a proper Outlet installed by a qualified electrician.

Grounded Tools: Tools with Three Prong Plugs

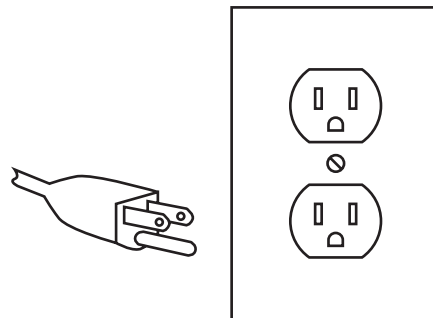

3-Prong Plug and Outlet

1. Tools marked with “Grounding Required” have a three wire cord and three prong grounding plug. The plug must be connected to a properly grounded outlet. If the tool should electrically malfunction or break down, grounding provides a low resistance path to carry electricity away from the user, reducing the risk of

electric shock.

(See 3-Prong Plug and Outlet.)

- The grounding prong in the plug is connected through the green wire inside the cord to the grounding system in the tool. The green wire in the cord must be the only wire connected to the tool's grounding system and must never be attached to an electrically "live" terminal.

(See 3-Prong Plug and Outlet.)

- The tool must be plugged into an appropriate outlet, properly installed and grounded in accordance with all codes and ordinances. The plug and outlet should look like those in the preceding illustration.

(See 3-Prong Plug and Outlet.)

- If you are using one Extension Cord for more than one tool, add the nameplate amperes and use the sum to determine the required minimum Cord size. **(See Table A.)**
- If you are using an Extension Cord outdoors, make sure it is marked with the suffix "W-A" ("W" in Canada) to indicate it is acceptable for outdoor use.
- Make sure the Extension Cord is properly wired and in good electrical condition. Always replace a damaged Extension Cord or have it repaired by a qualified electrician before using it.
- Protect the Extension Cords from sharp objects, excessive heat, and damp or wet areas.

EXTENSION CORDS

- Grounded tools require a three wire extension cord.
- As the distance from the supply outlet increases, you must use a heavier gauge Extension Cord. Using extension cords with inadequately sized wire causes a serious drop in voltage, resulting in loss of power and possible tool damage. **(See Table A.)**
- The smaller the gauge number of the wire, the greater the capacity of the Cord. For example, a 14 gauge Cord can carry a higher current than a 16 gauge Cord. **(See Table A.)**
- When using more than one Extension Cord to make up the total length, make sure each Cord contains at least the minimum wire size required. **(See Table A.)**





RECOMMENDED MINIMUM WIRE GAUGE FOR EXTENSION CORDS*
(120/240 VOLT)

NAMEPLATE AMPERES (at full load)	EXTENSION CORD LENGTH				
	25'	50'	75'	100'	150'
0 – 2.0	18	18	18	18	16
2.1 – 3.4	18	18	18	16	14
3.5 – 5.0	18	18	16	14	12
5.1 – 7.0	18	16	14	12	12
7.1 – 12.0	18	14	12	10	-
12.1 – 16.0	14	12	10	-	-
16.1 – 20.0	12	10	-	-	-

TABLE A

* Based on limiting the line voltage drop to five volts at 150% of the rated amperes.

SYMBOLOLOGY

	Double Insulated
	Canadian Standards Association
	Underwriters Laboratories, Inc.
	Volts Alternating Current
	Amperes
n_0 xxxx/min.	No Load Revolutions per Minute (RPM)

SPECIFICATIONS

Electrical Requirements	120 V~ / 60 Hz / 130 Watts Power Switch: Push Button ON/OFF Power Cord: 18 AWG x 3C Power Plug: 3-Prong, Grounded Internal Temperature Control: Rheostat Power Indicator Light: Red L.E.D.
Product Applications	Sharp edge of Blade for line cutting. Side of Blade for wide groove cutting.
Cutting Depth Adjustments	(3-3/4" with Scale Bracket) (5-7/16" without Scale Bracket)
Temperature Ranges	1-Level = 0° Fahrenheit 2-Level = 248° Fahrenheit 3-Level = 527° Fahrenheit 4-Level = 725° Fahrenheit 5-Level = 840° Fahrenheit
Additional Features	Push Button, momentary, ON/OFF Power Switch (Automatically returns to OFF position when released).

UNPACKING

When unpacking, check to make sure that the item is intact and undamaged. If any parts are missing or broken, please call Harbor Freight Tools at the number shown on the cover of this manual as soon as possible.

PRODUCT FEATURES

FIGURE A

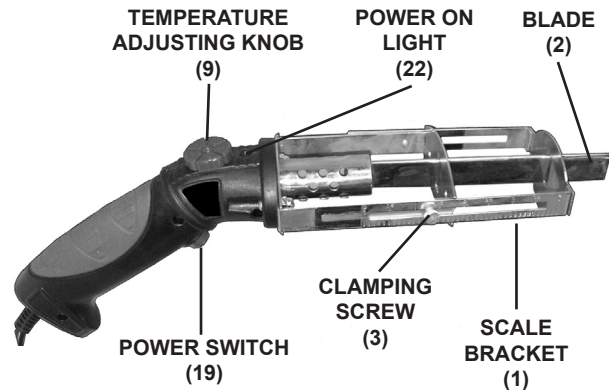

OPERATING INSTRUCTIONS



Read the **ENTIRE IMPORTANT SAFETY INFORMATION** section at the beginning of this manual including all text under subheadings therein before set up or use of this product.



TO PREVENT SERIOUS INJURY

FROM ACCIDENTAL OPERATION:

Turn the Power Switch (19) of the tool to its "OFF" position and unplug the tool from its electrical Outlet before performing any inspection, maintenance, or cleaning procedures.

To Adjust The Cutting Depth:

1. The cutting depth of the Hot Knife may be adjusted up to 3-3/4" when using the Scale Bracket. To adjust the depth, loosen the two Clamping Screws (3). Pull out or retract the Scale Bracket to the desired cut-

ting depth. Then retighten the two Clamping Screws. **(See Figure A.)**

Work Area and Workpiece Set Up:

1. Designate a well ventilated work area that is clean and well-lit. The work area must not allow access by children or pets to prevent injury and distraction.
2. Use and lay this Hot Knife on a non-flammable surface only.
3. Always have multiple class ABC fire extinguishers nearby.
4. Route the Power Cord (21) along a safe route to reach the work area without creating a tripping hazard or exposing the Power Cord to possible damage. The Power Cord must reach the work area with enough extra length to allow free movement while working.
5. There must not be hazardous objects, such as utility lines or foreign objects, nearby that will present a hazard while working.

General Operating Instructions

1. Plug the Power Cord Plug (21) into the nearest 120 volt, grounded, electrical outlet.
2. Turn the Temperature Selector Knob (9) to the desired temperature. **(See Figure A.)**
 - **1-Level = 0° Fahrenheit**
 - **2-Level = 248° Fahrenheit**
 - **3-Level = 527° Fahrenheit**
 - **4-Level = 725° Fahrenheit**
 - **5-Level = 840° Fahrenheit**

3. Press and hold the Power Switch (19) to heat up the Blade (2). The Blade will reach the pre-set operating temperature in about one minute and will remain at the temperature selected. Also, the Power ON Light (22) will illuminate during operation. **(See Figure A.)**
4. When the Blade (2) has reached the pre-set temperature, you may use the *sharp edge* of the Blade for line cutting or use the *side* of the Blade for wide groove cutting.
5. When pressure on the Power Switch (19) is released, power to the Blade (2) is cut off and the Blade will cool down gradually. **(See Figure A.)**

WARNING

6. The residual heat on the Blade (2) takes several minutes to dissipate. Use caution while the Blade is still hot.
7. Unplug the Hot Knife from its electrical outlet.
8. Once the Hot Knife has completely cooled store the tool in a clean, dry, and safe location out of reach of children and other unauthorized persons.

MAINTENANCE AND SERVICING



Procedures not specifically explained in this manual must be performed only by a qualified technician.

⚠️ WARNING

TO PREVENT SERIOUS INJURY

FROM ACCIDENTAL OPERATION:

Turn the Power Switch (19) of the Hot Knife to its “OFF” position and unplug the tool from its electrical Outlet before performing any inspection, maintenance, or cleaning procedures.

TO PREVENT SERIOUS INJURY FROM TOOL FAILURE:

Do not use damaged equipment. If abnormal noise or vibration occurs, have the problem corrected before further use.

1. BEFORE EACH USE, inspect the general condition of the Hot Knife. Check for loose screws, misalignment or binding of moving parts, cracked or broken parts, damaged electrical wiring, and any other condition that may affect its safe operation.
2. AFTER USE, clean external surfaces of the tool with clean cloth.
3. **⚠️ WARNING!** If the Power Cord (21) of this power tool is damaged, it must be replaced only by a qualified service technician.

TROUBLESHOOTING

Problem	Possible Cause	Possible Solution
Hot Knife will not turn on.	<ol style="list-style-type: none"> 1. No power at electrical outlet. 2. Power Switch not pressed. 	<ol style="list-style-type: none"> 1. Check power at outlet. 2. Press and hold Power Switch.
Hot Knife turns on, but does not heat up.	<ol style="list-style-type: none"> 1. Temperature on Selector Knob not selected. 	<ol style="list-style-type: none"> 1. Turn the Temperature Selector Knob to the desired temperature setting.
Hot Knife does not maintain pre-selected heat temperature during operation.	<ol style="list-style-type: none"> 1. Power Switch not pressed and held. 	<ol style="list-style-type: none"> 1. Press and hold Power Switch throughout operation.



Follow all safety precautions whenever diagnosing or servicing the Hot Knife. Disconnect power supply before servicing.

PARTS LIST & ASSEMBLY DIAGRAM

Part #	Description	Qty.	Part #	Description	Qty.
1	Scale Bracket	1	12	Self Tapping Screw (ST3 x 14)	3
2	Blade	1	13	Housing (B)	1
3	Clamping Screw (M4 x 8)	2	14	Sheath	1
4	Blade Bracket	1	15	Electric Wire	1
5	Nut with Cover (M4)	2	16	Rubber Grip	1
6	Nut (M4)	2	17	On/Off Switch	1
7	Insulating Patch	1	18	Housing (A)	1
8	Heating Assembly	1	19	Power Switch	1
9	Temperature Selector Knob	1	20	Rating Label	2
10	Circuit Board	1	21	Power Cord/Plug	1
11	Pan Head Screw (M4 x 15)	2	22	Power ON Light	1

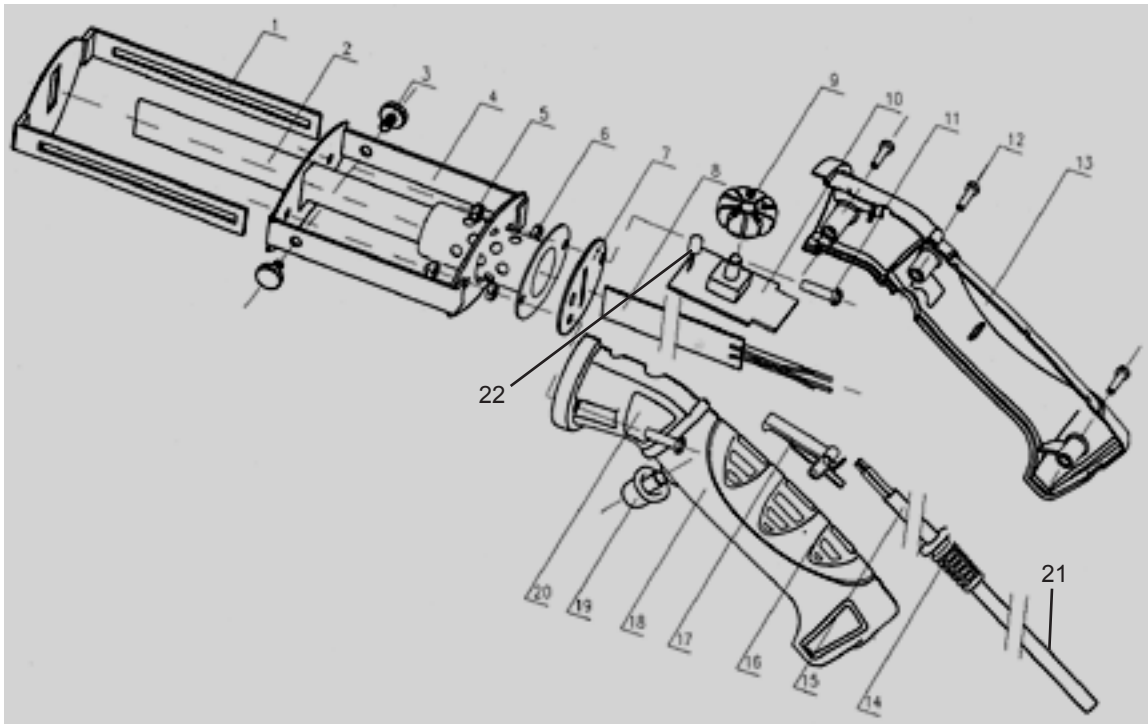

LIMITED 90 DAY WARRANTY

Harbor Freight Tools Co. makes every effort to assure that its products meet high quality and durability standards, and warrants to the original purchaser that this product is free from defects in materials and workmanship for the period of 90 days from the date of purchase. This warranty does not apply to damage due directly or indirectly, to misuse, abuse, negligence or accidents, repairs or alterations outside our facilities, criminal activity, improper installation, normal wear and tear, or to lack of maintenance. We shall in no event be liable for death, injuries to persons or property, or for incidental, contingent, special or consequential damages arising from the use of our product. Some states do not allow the exclusion or limitation of incidental or consequential damages, so the above limitation of exclusion may not apply to you. THIS WARRANTY IS EXPRESSLY IN LIEU OF ALL OTHER WARRANTIES, EXPRESS OR IMPLIED, INCLUDING THE WARRANTIES OF MERCHANTABILITY AND FITNESS.

To take advantage of this warranty, the product or part must be returned to us with transportation charges prepaid. Proof of purchase date and an explanation of the complaint must accompany the merchandise. If our inspection verifies the defect, we will either repair or replace the product at our election or we may elect to refund the purchase price if we cannot readily and quickly provide you with a replacement. We will return repaired products at our expense, but if we determine there is no defect, or that the defect resulted from causes not within the scope of our warranty, then you must bear the cost of returning the product.

This warranty gives you specific legal rights and you may also have other rights which vary from state to state.

3491 Mission Oaks Blvd. • PO Box 6009 • Camarillo, CA 93011 • (800) 444-3353

PLEASE READ THE FOLLOWING CAREFULLY

THE MANUFACTURER AND/OR DISTRIBUTOR HAS PROVIDED THE PARTS LIST AND ASSEMBLY DIAGRAM IN THIS MANUAL AS A REFERENCE TOOL ONLY. NEITHER THE MANUFACTURER OR DISTRIBUTOR MAKES ANY REPRESENTATION OR WARRANTY OF ANY KIND TO THE BUYER THAT HE OR SHE IS QUALIFIED TO MAKE ANY REPAIRS TO THE PRODUCT, OR THAT HE OR SHE IS QUALIFIED TO REPLACE ANY PARTS OF THE PRODUCT. IN FACT, THE MANUFACTURER AND/OR DISTRIBUTOR EXPRESSLY STATES THAT ALL REPAIRS AND PARTS REPLACEMENTS SHOULD BE UNDERTAKEN BY CERTIFIED AND LICENSED TECHNICIANS, AND NOT BY THE BUYER. THE BUYER ASSUMES ALL RISK AND LIABILITY ARISING OUT OF HIS OR HER REPAIRS TO THE ORIGINAL PRODUCT OR REPLACEMENT PARTS THERETO, OR ARISING OUT OF HIS OR HER INSTALLATION OF REPLACEMENT PARTS THERETO.

Record Product's Serial Number Here: _____

Note: If product has no serial number, record month and year of purchase instead.

Note: Some parts are listed and shown for illustration purposes only, and are not available individually as replacement parts.