

# EZI2996 Series User's Guide

## What's in the box?

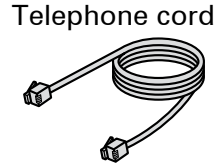

## You might also find:

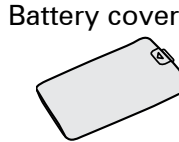
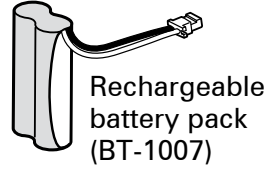
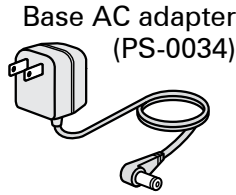
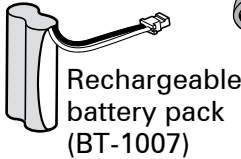
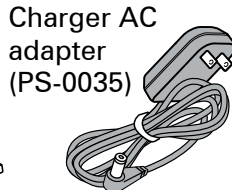

If you purchased model number:	You should have:
EZI2996	None
EZI2996-2	1 of each
EZI2996-3	2 of each
EZI2996-4	3 of each
EZI2996-5	4 of each
EZI2996-6	5 of each

If any items are missing or damaged, contact our Customer Care Line immediately. Never use damaged products!

Need Help? Get answers 24/7 at our website: [www.uniden.com](http://www.uniden.com).

If You...	Contact Uniden's...	Phone Number
have a question or problem	Customer Care Line*	817-858-2929 or 800-297-1023
need a replacement part or accessory (such as a belt clip, headset, or wall mount bracket)	Parts Department*	800-554-3988
need special assistance due to a disability	Accessibility Help Line	800-874-9314 (voice or TTY)

\* During regular business hours, Central Standard Time. Visit our website for detailed business hours.

## What's in the manual?

<b>Installing Your Phone</b> .....	<b>1</b>	<b>Using Special Features</b> .....	<b>15</b>
Charge the Battery .....	1	Using Do Not Disturb .....	15
Connect the Telephone Cord.....	2	Adjusting the Base Visual Ringer .....	16
<b>Getting to Know Your Phone</b> .....	<b>3</b>	Using the Audio Boost .....	16
Base Keys and How They Work .....	3	Using Text-To-Speech .....	16
Parts of the Handset.....	4	<b>Using a Voice Mail Service</b> .....	<b>17</b>
<b>Using the Menus</b> .....	<b>7</b>	Setting Up Your Voice Mail .....	17
The <i>Handset Setup</i> Menu .....	7	Getting Your Messages.....	17
<i>Day &amp; Time</i> Setting .....	8	Resetting the Voice Message Indicator	17
The <i>Global Setup</i> Menu .....	8	<b>Solving Problems</b> .....	<b>18</b>
Entering Text on Your Phone .....	8	Weak or Hard To Hear Audio .....	19
<b>Using Your Phone</b> .....	<b>9</b>	Noise or Static On The Line .....	19
Changing the Volume .....	10	Changing from Tone to Pulse Dialing ..	20
Using the Redial List.....	10	Resetting and Registering Handsets ...	21
Using Caller ID and Call Waiting .....	11	Handling Liquid Damage .....	22
Using Seven-Digit Dialing .....	12	<b>Important Information</b> .....	<b>23</b>
Using the Phonebook.....	12	Terms Used In This Guide .....	23
Chain Dialing .....	13	Specifications .....	23
Finding a Lost Handset .....	13	Battery Information .....	23
Using an Optional Headset .....	13	Compliance information .....	24
<b>Using Multi-Handset Features</b> .....	<b>14</b>	One-year Limited Warranty .....	26
Expanding Your Phone .....	14		
Using Conference Calling .....	14		
Using Call Transfer.....	14		
Using the Intercom.....	15		
Using Privacy Mode .....	15		

## Important Safety Precautions!

When using your telephone equipment, basic safety precautions should always be followed to reduce the risk of fire, electric shock and injury to persons, including the following:

- ◆ **This unit is NOT waterproof.** Do not expose it to rain or moisture.
- ◆ Do not use this product near water, for example, near a bath tub, wash bowl, kitchen sink or laundry tub, in a wet basement or near a swimming pool.
- ◆ Avoid using a telephone (other than a cordless type) during an electrical storm. There may be a remote risk of electric shock from lightning.
- ◆ Do not use the telephone to report a gas leak in the vicinity of the leak.
- ◆ Use only the power cord and batteries indicated in this manual. Do not dispose of batteries in a fire. They may explode. Check with local codes for possible special disposal instructions.
- ◆ Do not place the handset in any charging cradle without the battery installed and the battery cover securely in place.

---

**SAVE THESE INSTRUCTIONS!**

---

# Installing Your Phone

## Charge the Battery

- 1) Unpack all handsets, battery packs, and battery covers. If any battery cover is already on the handset, press in on the notch and slide the cover down and off.

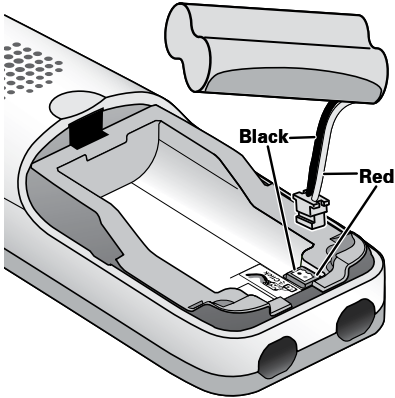
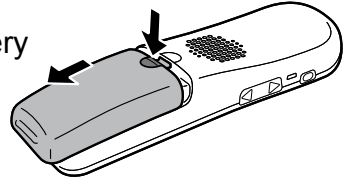

- 2) Line up the red and black wires on the battery pack with the label inside the handset.
- 3) Push the battery pack connector in until it clicks into place. Tug gently on the wires to make sure the battery pack is securely connected.
- 4) Place the cover over the battery compartment and slide it up into place.

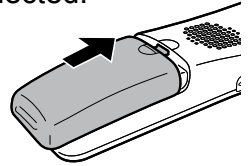

- 5) Connect the base AC adapter to the **AC IN 7.8V** jack on the back of the base. Route the cord through the molded wiring channel as shown.

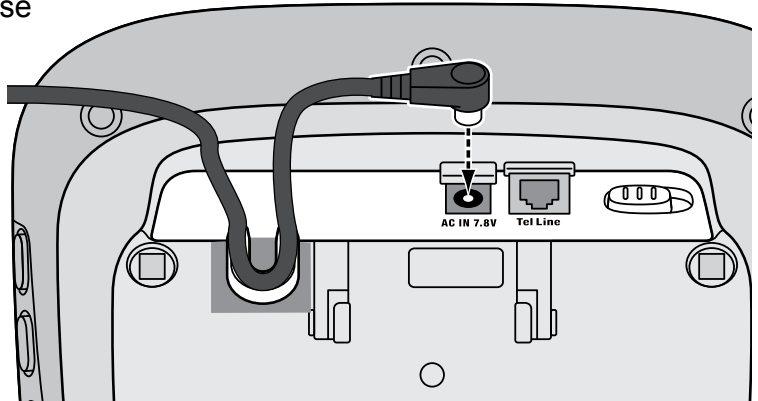

- 6) If you have accessory handsets, connect a charger AC adapter to each charger's **AC IN 8V** jack and set the plug into the notch as shown. (These adapters might already be connected.)
- 7) Plug the other end of each adapter into a standard 120V AC power outlet.

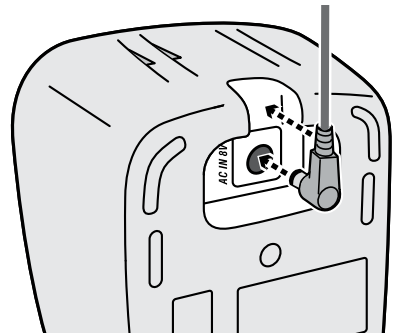

- 8) Place a handset in the base and any accessory handset(s) in the charger(s) with the display(s) facing forward. The **CHARGE** light on the base and each charger should all turn on.

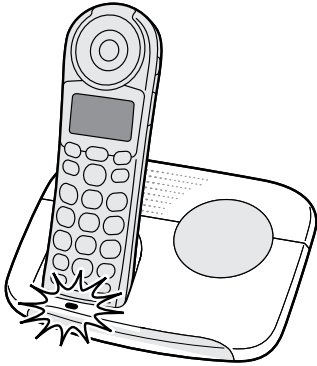

If...	Try...
the <b>CHARGE</b> light does not turn on	- reseating the handset. - checking the AC adapter connection. - seeing if the outlet is controlled by a wall switch.

**Charge all handsets completely (about 15 hours) before using them.**

## Connect the Telephone Cord

Use the telephone cord to connect the **TEL LINE** jack to a standard telephone wall jack.

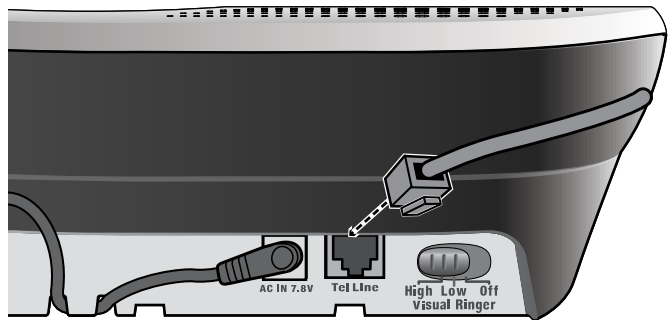

### Test the connection

- 1) Pick up the handset from the cradle and press **TALK**. You should hear a dial tone, and the display should say *Talk*.

If...	Try...
you don't hear a dial tone or the display says <i>Check Tel Line</i>	checking the connection between the base and the phone jack.

- 2) Make a quick test call. (Press **TALK** again to hang up.)

If...	Try...
you keep hearing a dial tone	changing to pulse dialing mode (see page 20).
there's a lot of noise or static	see page 19 for tips on avoiding interference.

- 3) Test any accessory handsets the same way. If you can't get a dial tone or the handset display says *Unavailable*, try moving the handset closer to the base or resetting it (see page 21).

# Getting to Know Your Phone

## Base Keys and How They Work

Front view

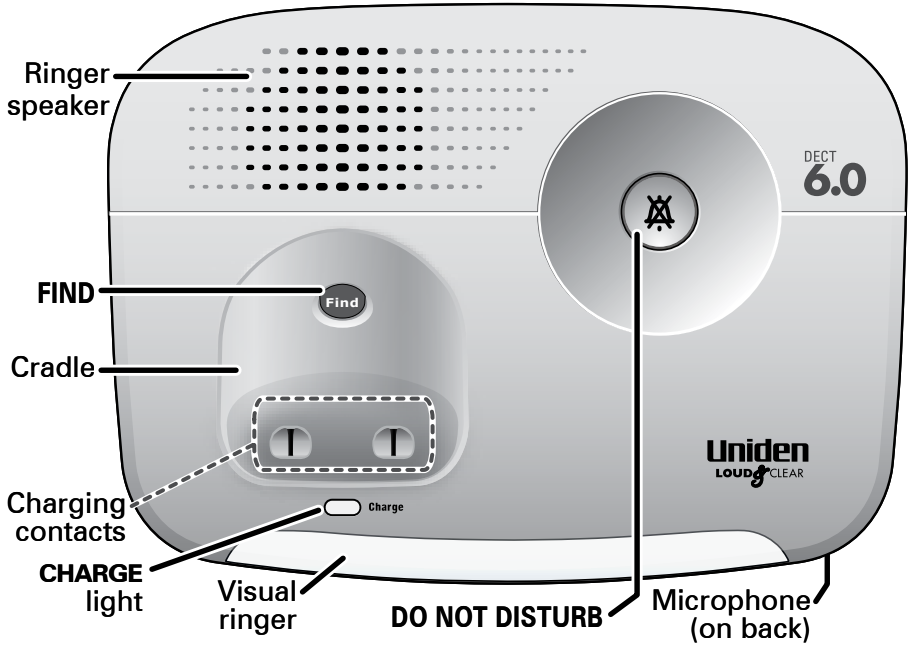

Side View

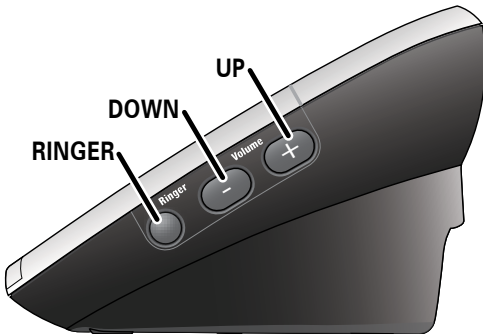

Back View

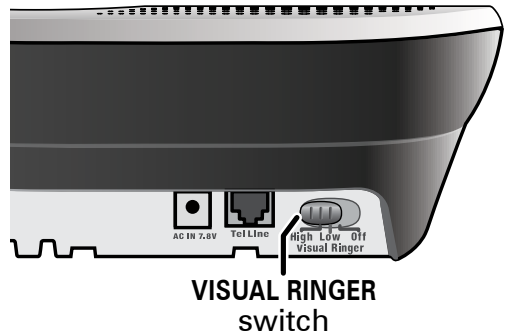

Key name (& icon)	What it does
DO NOT DISTURB (X)	- In standby: turn the Do Not Disturb feature on or off (see page 15).
FIND	- In standby: page all handsets so you can find a lost one.
RINGER	- In standby: cycle through the 4 different ringer tones.

Key name (& icon)	What it does
DOWN (—)	- In standby or while the phone is ringing: decrease the ringer volume.
UP (+)	- In standby or while the phone is ringing: increase the ringer volume.
VISUAL RINGER switch	- In standby: adjust the brightness of the base visual ringer (see page 16).

## Parts of the Handset

If the key name is spelled out on the key itself, it's not labeled in the drawing below.









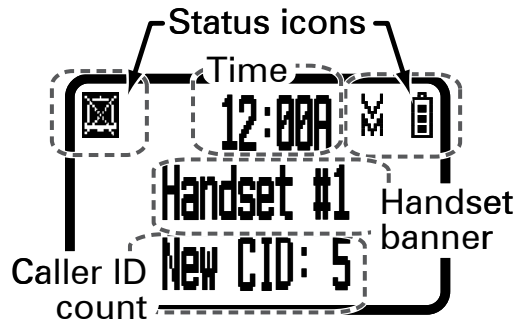

## Handset keys and how they work

Key name (and icon)	What it does
PHONEBOOK/ LEFT (PHBK)	<ul style="list-style-type: none"><li>- In standby or during a call: open the phonebook.</li><li>- In the menu: go back to the previous screen.</li><li>- During text entry: move the cursor to the left.</li></ul>
SPEAKER (SPKR)	<ul style="list-style-type: none"><li>- Switch a normal call to the speakerphone (and back).</li></ul>
SELECT/ MENU	<ul style="list-style-type: none"><li>- In standby: open the menu.</li><li>- In the menu or any list: select the highlighted item.</li></ul>
CALLER ID/ RIGHT (CID)	<ul style="list-style-type: none"><li>- In standby or during a call: open the Caller ID list.</li><li>- During text entry: move the cursor to the right.</li></ul>
TALK	<ul style="list-style-type: none"><li>- In standby: start a telephone call (get a dial tone).</li><li>- During a call: hang up.</li></ul>
FLASH/EXIT	<ul style="list-style-type: none"><li>- During a call: switch to a waiting call.</li><li>- While the phone is ringing: mute the ringer for this call only.</li><li>- In the menu or any list: exit the menu and go back to the previous operation.</li></ul>
CLEAR/ INTERCOM	<ul style="list-style-type: none"><li>- In standby: page another handset using the intercom.</li><li>- During a call: put the call on hold and start a call transfer.</li><li>- While entering text: delete the last character, or press and hold to delete all the characters.</li></ul>
REDIAL/ PAUSE	<ul style="list-style-type: none"><li>- In standby: open the redial list.</li><li>- During a phone number entry: insert a two-second pause.</li></ul>
MUTE/ MESSAGES	<ul style="list-style-type: none"><li>- In standby: access your voice mail (see page 17).</li><li>- During a call: mute the microphone.</li><li>- While the phone is ringing: mute the ringer for this call only.</li></ul>
BOOST	<ul style="list-style-type: none"><li>- During a call: boost the volume of the earpiece (see page 16).</li></ul>
UP (▲)	<ul style="list-style-type: none"><li>- In standby: increase the ringer volume.</li><li>- During a call: increase the call volume.</li><li>- In the menu or any list: move the cursor up one line.</li></ul>
DOWN (▼)	<ul style="list-style-type: none"><li>- In standby: decrease the ringer volume.</li><li>- During a call: decrease the call volume.</li><li>- In the menu or any list: move the cursor down one line.</li></ul>
TONE	<ul style="list-style-type: none"><li>- During a call: adjust the audio tone (see page 19).</li></ul>

## Reading the handset display

The table below shows the possible icons and what they mean. Since the icons appear based on what you're doing with the phone, you won't ever see all of these icons at the same time.



Icon	What it means
	The volume of the earpiece is boosted (see page 16).
	The ringer is turned off: this handset will not ring when a call comes in.
	You have a voice message waiting (see the section titled "Using a Voice Mail Service" on page 17).
	Privacy Mode is on: no other handset can use the line or join your call.
	The speakerphone is on.
	The microphone is muted, and the caller can't hear you.
	T-coil mode is on. (See "Do you have a T-coil hearing aid?" on page 19.)
	The battery is 1) fully charged, 2) half charged, 3) getting low, or 4) empty.



# Using the Menus

The menus are designed to be as easy as possible. Some users don't even need the manual once they know how to perform these basic actions:

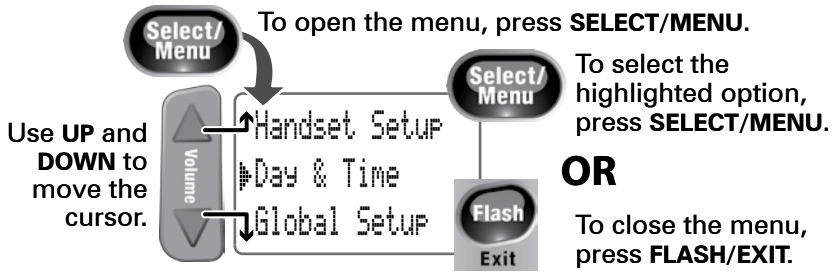

Open the menu	Press <b>SELECT/MENU</b> .
Move the cursor	The arrow cursor on the left side of the line shows which menu item is currently highlighted. Use <b>UP</b> to move the cursor up and <b>DOWN</b> to move it down.
Select an option	Move the cursor to highlight the option, then press <b>SELECT/MENU</b> .
Go back to the previous screen	Press <b>PHONEBOOK/LEFT</b> .
Close the menu	Press <b>FLASH/EXIT</b> .

**If you don't press any keys for thirty seconds, the phone times out and exits the menu. (When setting the day and time, the time-out period is extended to two minutes.)**

## The Handset Setup Menu

You have to change these settings separately for each handset.

<i>T-coil</i>	Turn on T-coil mode to reduce noise on certain hearing aids (see "Do you have a T-coil hearing aid?" on page 19).
<i>Edit Voice Mail</i>	Program an access number so you can access a voice mail service with the touch of a button (see "Using a Voice Mail Service" on page 17).
<i>Ringer Tones</i>	Choose one of two melodies or five tones for the handset's main ring tone. As you highlight each ring tone, the phone plays a sample of the tone. When you hear the tone you want, press <b>SELECT/MENU</b> .
<i>Personal Ring</i>	Turn on the personal ring feature. If you have Caller ID, this feature lets you assign special ring tones to anyone in your phonebook, and your phone uses the special ring tone when that person calls.

<i>Autotalk</i>	Turn on Auto Talk so you can answer the phone just by picking up the handset from the cradle (without pressing any buttons).
<i>Any Key Answer</i>	Turn on Any Key Answer so you can answer the phone by pressing any key on the twelve-key dial pad.
<i>Banner</i>	Change the name used on the handset's display.
<i>Handset Language</i>	Change the display language to <i>Spanish</i> or <i>French</i> .
<i>Key Touch Tone</i>	Have your keypad sound a tone when you press a key.
<i>LCD Contrast</i>	Change the contract of the display to make it easier to read. Choose one of ten different levels of contrast.
<i>TTS On/Off</i>	Turn on the Text-To-Speech (TTS) feature (see page 16).

## Day & Time Setting

If you set the day & time, the clock in your handset's display will be correct.

- 1) Use **UP** and **DOWN** to choose the day of the week; press **SELECT/MENU**.
- 2) Use the number keypad to enter the hour and minutes.
- 3) Use **UP** and **DOWN** to select *AM* or *PM*; press **SELECT/MENU**.

## The Global Setup Menu

The settings on this menu apply to all the handsets and the base. Before changing these settings, make sure the phone is in standby and all handsets are within range of the base. (Only one handset at a time can change these settings.)

<i>Area Code</i>	Enter your area code so the phone hides the area code on incoming local calls (see "Using Seven-digit Dialing" on page 12).
<i>Dial Mode</i>	Change the way your phone communicates with the telephone network (see "Changing from Tone to Pulse Dialing" on page 20).
<i>Voice Mail Tone</i>	Change the way your phone communicates with a voice mail service (see "Using a Voice Mail Service" on page 17).
<i>Set Line Mode</i>	Do not change this setting unless instructed to by customer service.

## Entering Text on Your Phone

When you want to enter text into your phone (for example, a name in the phonebook), use the twelve-key dial pad to enter the letters printed on the number keys. Here's how it works:

- ◆ The phone enters the letters in the order they appear on the key. For example, if you press the number key 2 once, the phone enters the letter *A*. Press 2 twice for *B*, and three times for *C*.
- ◆ If you press the key again after the last letter, the phone starts the same letter sequence with small letters. If you press 2 four times in a row, the phone enters *a* (small letter). Press 2 five times for *b*, and six times for *c*.
- ◆ If you see the icon *[Aa]* in the display, the phone enters capital letters first (*A B C*), then small letters (*a b c*), then the number on the key (2). The icon *[aA]* means the phone starts at the small letters, so it enters small letters first, then the number on the key, then capital letters.
- ◆ The phone automatically uses a capital letter for the first letter and any letter directly after a space; all other times, it uses small letters.
- ◆ If two letters in a row use the same number key, enter the first letter, then use **CALLER ID/RIGHT** to move the cursor to the next position to enter the second letter.

Switch between capital letters and small letters	Press <b>*</b> .
Move the cursor	Press <b>PHONEBOOK/LEFT</b> to move the cursor to the left. Press <b>CALLER ID/RIGHT</b> to move the cursor to the right.
Leave a blank space	Press <b>POUND (#)</b> .
Erase one letter	Move the cursor to the letter you want to erase and press <b>CLEAR/INTERCOM</b> .
Erase the entire entry	Press and hold <b>CLEAR/INTERCOM</b> .
Enter punctuation or a symbol	Press <b>0</b> to rotate through the available symbols.

---

## Using Your Phone

To...	With the earpiece	With the handset speaker
make a call: Dial the number, then...	press <b>TALK</b> . (To switch the call to the speaker, press <b>SPEAKER</b> .)	press <b>SPEAKER</b> . (To switch the call to the earpiece, press <b>SPEAKER</b> .)
answer a call	Press <b>TALK</b> .	Press <b>SPEAKER</b> .
hang up	Press <b>TALK</b> or return the handset to the cradle.	
put a call on hold	Press <b>CLEAR/INTERCOM</b> .	
return to a call on hold	Press <b>TALK</b> .	Press <b>SPEAKER</b> .
mute the microphone during a call	Press <b>MUTE/MESSAGES</b> . Press again to turn the microphone back on.	

## Changing the Volume

You can set the ringer, earpiece, and speaker volume separately for each handset. You can change the ringer volume on the base, also.

To change the...	Follow these steps...
handset ringer volume	With the phone in standby, press <b>UP</b> or <b>DOWN</b> to cycle through the available ringer volumes: <i>Off, Low, Medium, or High</i> .
handset speaker volume	While the speaker is playing (e.g., during a speakerphone call), press <b>UP</b> to make the speaker louder or <b>DOWN</b> to make it softer. Choose one of 6 volume levels.
handset earpiece volume	During a normal call, press <b>UP</b> to make the earpiece louder or <b>DOWN</b> to make it softer. Choose one of 6 volume levels.
base ringer volume	With the phone in standby or while it is ringing, press <b>UP</b> to make the ringer louder or <b>DOWN</b> to make it softer. Choose one of 3 volume levels or off.

**To change the volume of Caller ID announcements, change the ringer volume.**

### *Muting the ringer*

If you want a handset to stop ringing just for "right now", you can *mute* the ringer instead of turning it off. While the phone is ringing, press **MUTE/MESSAGES** or **FLASH/EXIT** to turn the ringer off for the current call only: the ringer automatically turns back on when the next call comes in.

## Using the Redial List

Each handset saves the last 5 numbers you dial on it.

Open the redial list	Press <b>REDIAL/PAUSE</b> .
Scroll through the list	Press <b>DOWN</b> to scroll through the list from newest to oldest. Press <b>UP</b> to scroll from oldest to newest.
Close the redial list	Press <b>FLASH/EXIT</b> or <b>PHONEBOOK/LEFT</b> .

With the phone in standby, open the list. Find the number you want, then:

to redial the selected number	Press <b>TALK</b> or <b>SPEAKER</b> .
to delete the number	Press <b>SELECT/MENU</b> and select <i>Delete Entry</i> .
to save it to the phonebook	Press <b>SELECT/MENU</b> and select <i>Store Into Pb</i> .

## Using Caller ID and Call Waiting

You have to subscribe to **Caller ID, Call Waiting, and Caller ID on Call Waiting** services to use the features described in this section: **contact your telephone provider for more information.**

When a call comes in, the phone displays the caller's number and name (if available); if you turned on Text-To-Speech, it also announces the name. The phone saves the information for the last 30 received calls to the *CID list*. When it's in standby, the phone displays how many new calls you've received since the last time you checked the CID list.

Open the CID list	Press <b>CALLER ID/RIGHT</b> .
Scroll through the CID list	Press <b>DOWN</b> to scroll through the list from newest to oldest. Press <b>UP</b> to scroll from oldest to newest.
Close the CID list	Press <b>PHONEBOOK/LEFT</b> .

### *Dialing from the Caller ID list*

- 1) Find the entry you want to dial.
- 2) If the phone number is a long distance or toll call, but the CID record doesn't have a **1** in front of it, press **\*** to add the **1**.
- 3) To dial the number, press **TALK** (or **SPEAKER** to use the speakerphone). You can also press **TALK** or **SPEAKER** before you open the CID list. Find the number you want to dial, then press **SELECT/MENU**.

### *Caller ID menu options*

Open the CID list with the phone in standby. Find the number you want and press **SELECT/MENU** to open the CID menu. You have these options:

<i>Delete Entry</i>	Erase this Caller ID number.
<i>Store Into Pb</i>	Add this number to this handset's phonebook. The handset will prompt you to enter the name, edit the phone number, and choose a personal ring.
<i>Delete All</i>	Erase this handset's CID list. (This does not affect the CID lists saved on any other handsets.)

### *Using Call Waiting*

If you get a Call Waiting call, the phone can sound a tone and display any CID information received for the waiting call. Press **FLASH/EXIT** to switch between your current call and the waiting call; remember, each time you switch, there is a short pause before you're connected to the other caller.

## Using Seven-Digit Dialing

If you can make a local call by dialing only seven digits instead of ten, you can tell the phone to hide your local area code in the CID list.

- 1) Open the menu and select *Global Setup*, then select *Area Code*.
- 2) Use the number keypad (0 - 9) to enter your three-digit area code.
- 3) Press **SELECT/MENU** when you're finished.

- ◆ The phone uses the programmed code as a filter. When calls come in, the phone compares the received area code to the programmed one. If they match, the phone hides the area code in the CID list.
- ◆ When you're in the CID list, press # to show the area code & re-hide it.
- ◆ If you dial a CID record or save it in the phonebook, the phone dials or saves the digits exactly as they appear on the display. If you have to use 10 digits, show the area code before you dial or save the number.

## Using the Phonebook

Each handset can store up to 70 entries in its phonebook.

Open or close the phonebook	Press <b>PHONEBOOK/LEFT</b> .
Scroll through the entries	Press <b>DOWN</b> to scroll through the phonebook from A to Z or <b>UP</b> to scroll from Z to A.
Jump to entries that start with a certain letter	Press the number key corresponding to the letter you want to jump to.
Dial an entry	Find the entry you want to dial and press <b>TALK</b> (or <b>SPEAKER</b> ).

### *Phonebook menu options*

Open the phonebook with the phone in standby, then press **SELECT/MENU** to open the phonebook menu. Choose one of these options:

<i>Create New</i>	Add an entry to your phonebook. The handset will prompt you to enter the name, edit the phone number, and choose a personal ring.
<i>Copy All</i>	Copy the whole phonebook to another handset. (You must have at least two handsets to use this feature.)
<i>Delete All</i>	Erase all the entries in this handset's phonebook. (This does not affect the entries saved on any other handsets.)

## Phonebook entry options

With the phone in standby, open the phonebook and find the entry you want. Press **SELECT/MENU** to open the individual phonebook entry menu. Choose one of these options:

<i>Edit</i>	Edit this entry. The handset will prompt you to edit the name and number, and choose a personal ring.
<i>Copy</i>	Copy this entry to another handset. (You must have at least two handsets to use this feature.)
<i>Delete</i>	Erase this entry.

## Chain Dialing

- ◆ If you often have to enter a series of digits or a code number during a call, you can save that code number to a phonebook entry and use the phonebook to send the code number.
- ◆ Enter the code number (up to 20 digits) into the phonebook just like a regular phonebook entry. Be sure to enter the code number into the phonebook exactly as you would enter it during a call.
- ◆ When you hear the prompt that tells you to enter the number, open the phonebook and find the entry that contains your code number. Press **SELECT/MENU** to transmit the code. The phone transmits the code number exactly as you entered it in the phonebook.

## Finding a Lost Handset

With the phone in standby, press **FIND** on the base. All handsets will beep for one minute, or until you press **FIND** again or press any key on the found handset.

## Using an Optional Headset

You can use a standard 2.5 mm telephone headset with your handsets. To purchase headsets, contact the Parts Department (see the front cover).

- ◆ To install a headset, remove the headset jack cover and insert the headset plug into the jack.
- ◆ Just make and receive calls as usual, and use your headset to talk to the caller after the call connects.
- ◆ When you connect a headset, the handset automatically mutes the earpiece and speaker. To re-activate the earpiece or speaker, just unplug the headset.

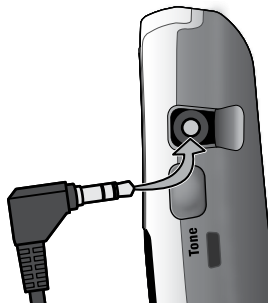

# Using Multi-Handset Features

The expandable base works together with the accessory handsets to give you some useful multi-handset features. You must have at least two handsets to use the features in this section.

## Expanding Your Phone

- ◆ Your base supports a total of six EZX290 accessory handsets, including any that were supplied with your phone. (The cordless handset that comes with your base counts as one of the six.)
- ◆ Your phone may be compatible with other Uniden accessory handsets. Please visit our website for a list of compatible handsets for your base.
- ◆ Accessory handsets must be registered to the base before you can use them. Handsets that have not been registered display a *Handset not registered* message. See page 21 for instructions on registering handsets to this base, or see the manual for the accessory handset.
- ◆ Any accessory handsets that came packaged with the base are already registered to that base for you.
- ◆ If a handset was previously registered to a base, you have to reset it so you can register it to a new base (see page 21 for EZX290 handsets).

## Using Conference Calling

When an outside call comes in, two handsets can join in a conference call with the outside caller. To join the call, just press **TALK**. To leave the conference call, hang up normally; the other handset remains connected to the call. (You can also use the speakerphone for a conference call, just like you can with a normal call.)

## Using Call Transfer

You can transfer an outside call to any handset. Follow these steps to...

transfer a call	<ol style="list-style-type: none"><li>1. Press <b>CLEAR/INTERCOM</b> to put the call on hold.</li><li>2. Select the handset you want to transfer the call to (select <i>A//</i> to page all the handsets).</li></ol> <p>When the other handset accepts the call, you'll be disconnected, but you can join the call again.</p>
cancel a transfer and return to the call	Press <b>TALK</b> .
accept a transferred call	<ol style="list-style-type: none"><li>1. Press <b>CLEAR/INTERCOM</b> to answer the page and speak to the transferring handset.</li><li>2. To accept the call, press <b>TALK</b>.</li></ol>



## Using the Intercom

Here are some general things you need to know about using the intercom:

- ◆ Whenever the phone is in standby, you can make an intercom call between handsets without using the phone line.
- ◆ You can make an intercom call from any handset, but only two handsets can be in an intercom call at any time.
- ◆ If an outside call comes in during an intercom call, the phone displays the Caller ID information. If the other handset hasn't answered the page, the phone cancels the page so you can answer the incoming call.

Follow these steps...

make an intercom page	1. Press <b>CLEAR/INTERCOM</b> . 2. Select the handset you want to talk with (select <i>All</i> to page all handsets).
cancel a page	Press <b>FLASH/EXIT</b> .
answer an intercom page	Press <b>CLEAR/INTERCOM</b> or <b>TALK</b> .
leave an intercom call	Press <b>FLASH/EXIT</b> .
answer an outside call during an intercom call	Press <b>TALK</b> .

## Using Privacy Mode

You can prevent other handsets from joining a call. Start your call as usual, then press **SELECT/MENU**: the display shows *Call Privacy*. Press **SELECT/MENU** again to turn privacy mode on (you'll see a **P** in the display). When you hang up this call, privacy mode turns off automatically.

As long you have privacy mode on, no other handsets can interrupt your call. If you want to let another handset join the call, repeat the process above (press **SELECT/MENU** twice) to turn privacy mode off.

---

## Using Special Features

### Using Do Not Disturb

- ◆ The *Do Not Disturb (DND)* feature turns off the audio ringers of the base and all handsets at the same time. (It doesn't affect the visual ringers.)
- ◆ With the phone in standby, press and hold **DO NOT DISTURB** on the base. The phone shows *Do Not Disturb* in the display on all handsets.
- ◆ To cancel, press **DO NOT DISTURB**.

## Adjusting the Base Visual Ringer

The **VISUAL RINGER** switch is at the back of the base; use this switch to change the brightness of the base visual ringer. (It doesn't affect the audio ringers.)

Slide the switch so that its center (marked with the arrow in the picture) lines up with the brightness you want to use: **HIGH**, **LOW**, or **OFF**.

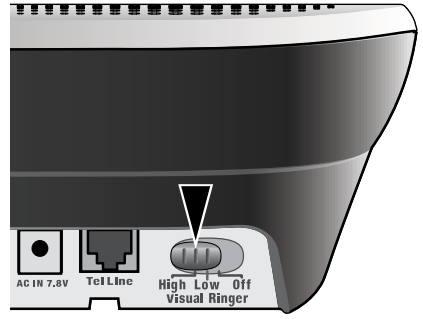

## Using the Audio Boost

You can increase the earpiece volume for normal calls and intercom calls. During a call, press **BOOST** to increase the volume of the audio. While audio boost is on,  appears in the display. Press **BOOST** again to turn off.

## Using Text-To-Speech

With the Text To Speech (TTS) feature, your phone can announce phone numbers or names in several different situations.

When you... (from standby)	The phone announces...
Receive a call	The caller's name (if sent by a Caller ID service)
Dial a number	The phone number you dialed
Open the phonebook	The name of the entry you are looking at

Things to know about TTS:

- ◆ You have to turn on TTS separately for each handset. Open the menu and select *Handset Setup*. Then, select *TTS On/off*, and select *On* or *Off* for each handset.
- ◆ To make sure it doesn't interrupt a call or an intercom page, the phone only uses TTS when it starts out in standby. For example, if you open the phonebook during a call, the phone won't announce the names in your phonebook.
- ◆ It takes at least 2 rings for the phone to receive Caller ID information and announce it. If the phone is answered before the end of the second ring, the phone won't have time to announce the name of the caller.
- ◆ To change the volume used for CID announcements, change the ringer volume. For other TTS features, change the handset speaker volume.
- ◆ The TTS feature only uses English to announce the name and numbers, regardless of what language is use for the display.

---

# Using a Voice Mail Service

If you subscribe to a voice mail service, your phone can notify you when you have a new message waiting; you can also program your access number so you can get your messages at the touch of a button.

## Setting Up Your Voice Mail

When you sign up for your voice mail, your service provider should give you an *access number* and the *message notification signal type*. If you don't have this information, contact your provider before you start.

- 1) With the phone in standby, open the menu.
- 2) Select *Handset Setup*, then select *Edit Voice Mail*. (You have to program the voice mail access number separately for each handset.)
- 3) Enter your access number exactly as you would dial it. You can enter a total of 20 digits. If you need the phone to wait for a few seconds between digits (to wait for the service to answer, for example), press **REDIAL/PAUSE** to insert a 2-second pause. If two seconds isn't long enough, you can insert as many pauses as you need, but each pause counts as one digit. Press **SELECT/MENU** when you're finished.
- 4) From the main menu, select *Global Setup*, then *Voice Mail Tone*.
- 5) If your voice mail service uses a *Frequency Shift Keying* or *FSK* message signal to let you know you have a new message, set the *Voice Mail Tone* to *Off*; if your service uses a *Stutter Dial Tone* or *SDT* signal, set the *Voice Mail Tone* to *On*.

**If you can't find out which signal your provider uses, leave the Voice Mail Tone on. If you don't see the voice message icon (📞) when you know there's a new message, turn the Voice Mail Tone off.**

## Getting Your Messages

When you have new messages, the voice message icon (📞) appears in the handset display. Press **MUTE/MESSAGES** to dial the access number you programmed into this handset.

## Resetting the Voice Message Indicator

If the voice message icon won't go away after you check your messages, you can reset it. Press and hold **FIND** until the light turns off (about five seconds).

**Your handsets will beep during this process: just ignore them.**

# Solving Problems

If you have any trouble with your phone, try these simple steps first. If you still have a question, call our Customer Care Line listed on the front cover.

If...	Try...
No handsets can make or receive calls.	<ul style="list-style-type: none"> <li>- Checking the telephone cord connection.</li> <li>- Disconnecting the base AC adapter. Wait a few minutes, then reconnect it.</li> </ul>
One handset can't make or receive calls.	<ul style="list-style-type: none"> <li>- Moving the handset closer to the base.</li> <li>- Resetting the handset.</li> </ul>
A handset can make calls, but it won't ring.	<ul style="list-style-type: none"> <li>- Making sure the ringer is turned on.</li> <li>- Making sure Do Not Disturb is turned off.</li> </ul>
A handset's display won't turn on.	<ul style="list-style-type: none"> <li>- Charging the battery for 15-20 hours.</li> <li>- Checking the battery pack connection.</li> </ul>
A handset is not working.	<ul style="list-style-type: none"> <li>- Checking the battery pack connection.</li> <li>- Charging the battery for 15-20 hours.</li> <li>- Resetting the handset.</li> </ul>
A handset says <i>Unavailable</i> .	<ul style="list-style-type: none"> <li>- Moving the handset closer to the base.</li> <li>- Seeing if another handset has Privacy Mode on.</li> <li>- Making sure the base is plugged in.</li> </ul>
No handsets will display any Caller ID information.	<ul style="list-style-type: none"> <li>- Letting incoming calls ring at least twice before answering.</li> <li>- Seeing if the call was placed through a switchboard.</li> <li>- Checking with your telephone service provider to make sure your Caller ID service is active.</li> </ul>
Caller ID displays briefly and then clears.	<ul style="list-style-type: none"> <li>- You may have to change the line mode. Contact customer service for more information.</li> </ul>
Caller ID displays, but I can't hear the CID announcements.	<ul style="list-style-type: none"> <li>- Making sure TTS (Text-To-Speech) is turned on.</li> <li>- Increasing the ringer volume so the CID announcements are louder.</li> </ul>
I can't transfer calls.	<ul style="list-style-type: none"> <li>- Resetting all the handsets.</li> </ul>
I can't get two handsets to talk to the caller.	<ul style="list-style-type: none"> <li>- Making sure both handsets are registered to this base.</li> <li>- Making sure a handset is not in Privacy Mode.</li> </ul>
The phone keeps ringing when I answer on an extension.	<ul style="list-style-type: none"> <li>- You may have to change the line mode. Contact customer service for more information.</li> </ul>
The voice message icon never shows up.	<ul style="list-style-type: none"> <li>- Checking the <i>Voice Mail Tone</i>. If it's set to Off, try turning it on, and vice versa (see page 17).</li> </ul>

If...	Try...
The voice message icon won't go away.	- Resetting the Voice Message Waiting Indicator (see page 17).
I can't register a handset.	- Seeing if you already have 6 handsets registered to this base. - Resetting the handset.

## Weak or Hard To Hear Audio

If a caller's voice sounds weak or soft, the signal might be blocked by large metal objects or walls; you might also be too far from the base, or the handset's battery may be weak.

- ◆ Try moving around while you're on a call or moving closer to the base to see if the sound gets louder.
- ◆ Make sure the handset's battery is fully charged.
- ◆ Try adjusting the volume of the earpiece or the audio tone (see below).

### *Adjust the audio tone*

During a call, press **TONE** to cycle through the three audio tone options: *High Tone*, *Natural Tone* (recommended for hearing aid users), or *Low Tone*. (The tone setting appears in the display as you do this.) You may have to experiment to figure out which audio tone works best for you.

## Noise or Static On The Line

The most common cause of noise or static on a cordless phone is interference. Here are some common household sources of interference:

- ◆ electrical appliances, especially microwave ovens
- ◆ computer equipment, especially wireless LAN equipment and DSL modems
- ◆ radio-based wireless devices, such as room monitors, wireless controllers, or wireless headphones or speakers
- ◆ large florescent light fixtures (especially if they give off a buzzing noise)

### **Do you have a T-Coil hearing aid?**

If you have a hearing aid equipped with a telecoil (T-coil) feature, the interaction between the hearing aid and digital cordless phones can cause noise in the handset. If you have a T-coil hearing aid and you have problems with noise on the line, try turning on *T-coil* mode. Open the menu. Select *Handset Setup*, then select *T-coil*.

**Using T-coil mode can shorten the handset's talk time; make sure to watch your battery status and keep the battery charged.**

- ◆ other services that use your phone line, like alarm systems, intercom systems, or broadband Internet service

Here are some hints for when the static is...

on 1 handset or in 1 location:	on all handsets or in all locations:
<ul style="list-style-type: none"> <li>- Check nearby for one of the common interference sources.</li> <li>- Try moving the handset away from a suspected source, or try moving the suspected source so it's not between the handset and the base.</li> <li>- Try moving closer to the base. There is always more noise at the edges of the base's range. If the handset displays an <i>Out of Range</i> message, you need to move closer to the base.</li> </ul>	<ul style="list-style-type: none"> <li>- Check near the base for the source of interference.</li> <li>- Try moving the base away from a suspected source, or turn off the source if possible.</li> <li>- If the base has an adjustable antenna, try raising the antenna so it stands straight up.</li> <li>- If you have any service that uses the phone line, you might need a filter (see below).</li> </ul>

### *Installing a telephone line filter or DSL filter*

Sometimes, broadband Internet services that use the telephone line can interfere with phones. One of these services—DSL—often causes static on telephones. A *DSL filter* or telephone line filter usually solves this problem. The technician who installed your DSL service might have left some filters for you; if not, call your DSL provider or look in any electronics store.

Plug the DSL filter into the telephone wall jack and then plug your phone's base into the filter. Make a test call to make sure the noise is gone.

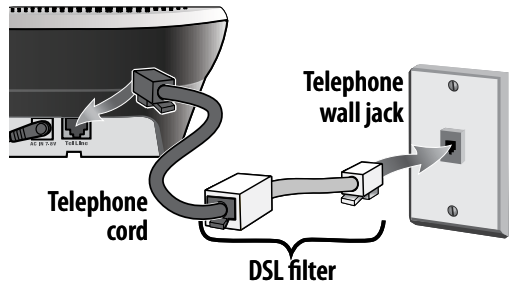

## **Changing from Tone to Pulse Dialing**

Your phone can communicate with the telephone network in two different ways: tone dialing or pulse dialing. These days, most telephone companies use tone dialing. If your phone company uses pulse dialing, you need to change the dial mode.

- 1) With the phone in standby, open the menu and select *Global Setup*.
- 2) Select *Dial Mode*, then select *Pulse*. The phone sounds a confirmation tone.

If you use pulse dialing and you need to send DTMF tones during a call (if you're using an automated response system, for example), press **★** to temporarily switch to tone dialing. When the call ends, the phone automatically returns to pulse dialing mode.

## Resetting and Registering Handsets

If you are having trouble with a handset or if you want to replace one, you need to clear the registration information from the base and the handset:

Do you have the base the handset is registered to?	
Yes	No
<ol style="list-style-type: none"> <li>1. Press and hold <b>FLASH/EXIT</b> and <b>POUND (#)</b> until the <i>System Reset</i> menu appears (about 5 seconds).</li> <li>2. Select <i>Deregister HS</i>. The display lists all registered handsets.</li> <li>3. Select the handset you want to reset.</li> <li>4. When the phone asks you to confirm, select <i>Yes</i>. The handset clears its information from the base and deletes its own link to the base.</li> </ol>	<ol style="list-style-type: none"> <li>1. Press and hold <b>FLASH/EXIT</b> and <b>POUND (#)</b> until the <i>System Reset</i> menu appears (about 5 seconds).</li> <li>2. Select <i>Base Unavailable</i>.</li> <li>3. When the phone asks you to confirm, select <i>Yes</i>. The handset deletes its own link without contacting the base.</li> </ol>

When you reset a handset (or if you purchase a new one), that handset displays a *Handset Not Registered* message. If you see this message on a handset, you need to register it to a base before you can use it.

### Registering a handset

Does the handset fit in the base cradle?	
Yes	No
Place the handset in the base. The display should say <i>Handset Registering</i> .	<ol style="list-style-type: none"> <li>1. Disconnect the base AC adapter.</li> <li>2. Press and hold <b>FIND</b> while you reconnect the adapter.</li> <li>3. On the handset, press and hold <b>POUND (#)</b> until the display says <i>Handset Registering</i> (about 2 seconds).</li> </ol>

In about 30 seconds, the display should say *Registration Complete*. Pick up the handset and press **TALK**. Make sure you get a dial tone.

If...	Try...
<ul style="list-style-type: none"> <li>- you don't hear a dial tone</li> <li>- the display says <i>Registration Failed</i></li> </ul>	Making sure the handset is fully charged, then trying again.

**To register a handset to a different base, see the section "Expanding Your Phone" in the user's guide for the other base.**

# Handling Liquid Damage

Moisture and liquid can damage your cordless phone.

- ◆ If the handset or base is exposed to moisture or liquid, but only the exterior plastic housing is affected, wipe off the liquid & use as normal.
- ◆ If moisture or liquid has entered the plastic housing (i.e. liquid can be heard in the phone or liquid has entered the handset battery compartment or vent openings on the base), follow the steps below:

Handset	Base
<ol style="list-style-type: none"><li>1. Remove the battery cover and leave it off for ventilation.</li><li>2. Disconnect the battery pack. Leave the battery cover off &amp; the battery pack disconnected for at least 3 days.</li><li>3. Once the handset is completely dry, reconnect the battery pack and the battery cover.</li><li>4. Recharge the battery pack for 15-20 hours before using.</li></ol>	<ol style="list-style-type: none"><li>1. Disconnect the AC adapter, cutting off electrical power.</li><li>2. Disconnect the telephone cord from the base.</li><li>3. Let dry for at least 3 days.</li></ol>

**IMPORTANT: You must unplug the telephone line while recharging the battery pack to avoid charge interruption.**

---

***CAUTION! DO NOT use a microwave oven to speed up the drying process. This will cause permanent damage to the handset, base and the microwave oven.***

---



# Important Information

## Terms Used In This Guide

Accessory Handset	An extra handset that can register to and be used with an expandable phone base. All accessory handsets must be registered to a base.
Base	The main part of the phone. It connects to your phone line and lets you make and receive calls. Most bases also have a cradle to store a handset.
CIDCW	(CID on Call Waiting.) A service that shows CID for calls that come in during another call.
Call Waiting	A service that lets you receive calls while you are on another call.
Caller ID	(Also called CID.) A service that shows the name and number of incoming callers.
Charger	A cradle that stores and charges a handset but doesn't connect to the phone line.
Cradle	The part of the phone that stores a handset. While in a cradle, a handset is always in standby, and any keys are locked.
During a call	The handset is currently on a call or has activated a dial tone.
Handset	A cordless handset that you use to dial the phone and talk to callers.
In standby	The phone is inactive at the moment: there is no dial tone, no handset is on a call or listening to messages.
TTS	(Text to speech) A technology that reads data in a synthesized voice. TTS is used to announce incoming CID information, read numbers from the phonebook, etc.

## Specifications

AC adapter		Base	Charger
	Part number	PS-0034	PS-0035
	Input voltage	120V AC, 60 Hz	120V AC, 60 Hz
	Output voltage	7.8V AC @ 450mA	8V AC @ 300mA
Battery pack	Part number	BT-1007	
	Capacity	500mAh, 2.4V DC	

- ◆ Use only the supplied AC adapters.
- ◆ Be sure to use the proper adapter for the base and any chargers.
- ◆ Do not place the base in direct sunlight or subject it to high temperatures.
- ◆ Do not place the power cord where it creates a trip hazard or where it could become chafed and create a fire or electrical hazard.

## Battery Information

- ◆ Fully charged, the battery should provide about 10 hours of talk time and about 7 days of standby time. For best results, return the handset to the cradle after each call to keep it fully charged.
- ◆ Keep an eye on the battery status icon. When the battery gets too low, the handset shows a low battery alert. If you hear a strange beep during a call, check the display: if you see the low battery alert, finish your conversation as quickly as possible and return the handset to the cradle. If the handset is in standby, none of the keys will operate.
- ◆ With normal use, the battery should last about one year. Replace the battery when the talk time becomes short even when the battery is charged. To buy a replacement battery, call the Parts Department listed on the front cover.

## Rechargeable Nickel-Cadmium Battery Warning

**CAUTION! Risk of explosion if battery is replaced by an incorrect type! Dispose of used batteries according to the instructions. Do not open or mutilate the battery. Disconnect the battery before shipping this product.**

- ◆ This equipment contains a rechargeable nickel-cadmium (Ni-Cd) battery.
- ◆ Cadmium and Nickel are chemicals known to the State of California to cause cancer.
- ◆ Do not short-circuit the battery.

- ◆ The rechargeable Ni-Cd battery contained in this equipment may explode if disposed of in a fire.
- ◆ Do not charge the battery used in this equipment in any charger other than the one designed to charge this battery as specified in the owner's manual. Using another charger may damage the battery or cause it to explode.
- ◆ As part of our commitment to protecting our environment and conserving natural resources, Uniden voluntarily participates in an RBRC® industry program to collect and recycle used Ni-Cd batteries within the United States. Please call 1-800-8-BATTERY for information on Ni-Cd battery recycling in your area. (RBRC® is a registered trademark of the Rechargeable Battery Recycling Corporation.)



### **Rechargeable Batteries Must Be Recycled or Disposed of Properly.**

**Uniden works to reduce lead content in PVC coated cords in our products and accessories.**

---

***Warning! The cords on this product and/or accessories contain lead, a chemical known to the State of California to cause birth defects or other reproductive harm. Wash hands after handling.***

---

## **Compliance information**

### ***FCC Part 68 information***

This equipment complies with Part 68 of the FCC rules and the requirements adopted by the ACTA. On the bottom of this equipment is a label that contains, among other information, a product identifier in the format US: AAAEQ##TXXXX. If requested, this number must be provided to the phone company.

An applicable Universal Service Order Codes (USOC) certification for the jacks used in this equipment is provided (i.e., RJ11C) in the packaging with each piece of approved terminal equipment. A plug and jack used to connect this equipment to the premises wiring and telephone network must comply with the applicable FCC Part 68 rules and requirements adopted by the ACTA. A compliant telephone cord and modular plug is provided with this product. It is designed to be connected to a compatible modular jack that is also compliant. See installation instructions for details.

The REN is used to determine the number of devices that may be connected to a phone line. Excessive RENs on a phone line may result in devices not ringing in response to an incoming call. In most but not all areas, the sum of RENs should not exceed five (5.0). To be certain of the number of devices that may be connected to a line, as determined by the total RENs, contact the telephone provider. The REN for this product is part of the product identifier that has the format US: AAAEQ##TXXXX. The digits represented by ## are the REN without a decimal point (e.g., 03 is a REN of 0.3).

If this equipment causes harm to the telephone network, the telephone company will notify you in advance that temporary discontinuance of service may be required. But if advance notice isn't practical, the telephone company will notify the customer as soon as possible. Also, you will be advised of your right to file a complaint with the FCC if you believe it is necessary. The telephone company may make changes in its facilities, equipment, operations or procedures that could affect the operation of the equipment. If this happens the telephone company will provide advance notice in order for you to make necessary modifications to maintain uninterrupted service.

Please follow instructions for repairing, if any (e.g. battery replacement section); otherwise do not substitute or repair any parts of the device except as specified in this manual. Connection to party line service is subject to state tariffs. Contact the state public utility commission, public service commission or corporation commission for information. This equipment is hearing aid compatible.

If you experience trouble with this equipment, contact the manufacturer (see the cover of this manual for contact information) or an authorized agent. If the equipment is causing harm to the telephone network, the telephone company may request that you disconnect the equipment until the problem is resolved.

If your home has wired alarm equipment connected to a phone line, be sure that installing the system does not disable your alarm equipment. If you have questions about what will disable alarm equipment, contact your telephone company or a qualified installer.

Any changes or modifications to this product not expressly approved by the manufacturer or other party responsible for compliance could void your authority to operate this product.

NOTICE: According to telephone company reports, AC electrical surges, typically resulting from lightning strikes, are very destructive to telephone equipment connected to AC power sources. To minimize damage from these types of surges, a surge arrestor is recommended.

### ***FCC Part 15 information***

This device complies with part 15 of the FCC rules. Operation is subject to the following two conditions: (1) This device may not cause harmful interference, and (2) This device must accept any interference received, including interference that may cause undesired operation. Privacy of communications may not be ensured when using this phone.

**FCC PART 15.105(b):** Note: This equipment has been tested and found to comply with the limits for a Class B digital device, pursuant to part 15 of the FCC Rules. These limits are designed to provide reasonable protection against harmful interference in a residential installation. This equipment generates, uses and can radiate radio frequency energy and, if not installed and used in accordance with the instructions, may cause harmful interference to radio communications. However, there is no guarantee that interference will not occur in a particular installation. If this equipment does cause harmful interference to radio or television reception, which can be determined by turning the equipment off and on, the user is encouraged to try to correct the interference by one or more of the following measures:

- ◆ Reorient or relocate the receiving antenna.
- ◆ Increase the separation between the equipment and receiver.
- ◆ Connect the equipment into an outlet on a circuit different from that to which the receiver is connected.
- ◆ Consult the dealer or an experienced radio/TV technician for help.

This product complies with FCC radiation exposure limits under the following conditions:

- ◆ The base must be placed to allow a minimum of 20 cm (8 in) between the antenna and all persons during normal operation.
- ◆ The base must not be collocated or operated in conjunction with any other antenna or transmitter.
- ◆ The handset is designed for body-worn operation and meets FCC RF exposure guidelines when used with any belt clip, carrying case, or other accessory supplied with this product. (All necessary accessories are included in the package; any additional or optional accessories are not required for compliance with the guidelines.) Third party accessories (unless approved by the manufacturer) should be avoided as these might not comply with FCC RF exposure guidelines.

### ***Industry Canada (I.C.) Notice***

#### ***Terminal equipment***

NOTICE: This equipment meets the applicable Industry Canada Terminal Equipment Technical Specifications. This is confirmed by the registration number. The abbreviation *IC* before the registration number signifies that registration was performed based on a Declaration of Conformity indicating that Industry Canada technical specifications were met. It does not imply that Industry Canada approved the equipment.

NOTICE: The Ringer Equivalence Number (REN) for this terminal equipment is marked on the equipment itself. The REN assigned to each terminal equipment provides an indication of the maximum number of terminals allowed to be connected to a telephone interface. The termination on an interface may consist of any combination of devices subject only to the requirement that the sum of the Ringer Equivalence Numbers of all the devices does not exceed 5.

#### ***Radio equipment***

The term *IC* before the radio certification number only signifies that Industry Canada technical specifications were met. Operation is subject to the following two conditions: (1) this device may not cause interference, and (2) this device must accept any interference, including interference that may cause undesired operation of the device. "Privacy of communications may not be ensured when using this telephone".

# One-year Limited Warranty

**Important: Evidence of original purchase is required for warranty service.**

**WARRANTOR: UNIDEN AMERICA CORPORATION ("Uniden") ELEMENTS OF WARRANTY:**

Uniden warrants, for one year, to the original retail owner, this Uniden Product to be free from defects in materials and craftsmanship with only the limitations or exclusions set out below.

**WARRANTY DURATION:** This warranty to the original user shall terminate and be of no further effect 12 months after the date of original retail sale. The warranty is invalid if the Product is (A) damaged or not maintained as reasonable or necessary, (B) modified, altered, or used as part of any conversion kits, subassemblies, or any configurations not sold by Uniden, (C) improperly installed, (D) serviced or repaired by someone other than an authorized Uniden service center for a defect or malfunction covered by this warranty, (E) used in any conjunction with equipment or parts or as part of any system not manufactured by Uniden, or (F) installed or programmed by anyone other than as detailed by the owner's manual for this product.

**STATEMENT OF REMEDY:** In the event that the product does not conform to this warranty at any time while this warranty is in effect, warrantor will either, at its option, repair or replace the defective unit and return it to you without charge for parts, service, or any other cost (except shipping and handling) incurred by warrantor or its representatives in connection with the performance of this warranty. Warrantor, at its option, may replace the unit with a new or refurbished unit. THE LIMITED WARRANTY SET FORTH ABOVE IS THE SOLE and ENTIRE WARRANTY PERTAINING TO THE PRODUCT and IS IN LIEU OF and EXCLUDES ALL OTHER WARRANTIES OF ANY NATURE WHATSOEVER, WHETHER EXPRESS, IMPLIED OR ARISING BY OPERATION OF LAW, INCLUDING, BUT NOT LIMITED TO ANY IMPLIED WARRANTIES OF MERCHANTABILITY OR FITNESS FOR A PARTICULAR PURPOSE. THIS WARRANTY DOES NOT COVER OR PROVIDE FOR THE REIMBURSEMENT OR PAYMENT OF INCIDENTAL OR CONSEQUENTIAL DAMAGES. Some states do not allow this exclusion or limitation of incidental or consequential damages so the above limitation or exclusion may not apply to you.

**LEGAL REMEDIES:** This warranty gives you specific legal rights, and you may also have other rights which vary from state to state. This warranty is void outside the United States of America and Canada.

**PROCEDURE FOR OBTAINING PERFORMANCE OF WARRANTY:** If, after following the instructions in the owner's manual you are certain that the Product is defective, pack the Product carefully (preferably in its original packaging). Disconnect the battery from the Product and separately secure the battery in its own separate packaging within the shipping carton. The Product should include all parts and accessories originally packaged with the Product. Include evidence of original purchase and a note describing the defect that has caused you to return it. The Product should be shipped freight prepaid, by traceable means, to warrantor at:

Uniden America Service  
4700 Amon Carter Blvd.  
Fort Worth, TX 76155

As an Energy Star<sup>®</sup> Partner, Uniden has determined that this product meets the Energy Star<sup>®</sup> guidelines for energy efficiency. Energy Star<sup>®</sup> is a U.S. registered mark.



- ◆ Uniden<sup>®</sup> is a registered trademark of Uniden America Corporation.
- ◆ Call waiting, CID, CIDCW, and Voice Mail are telephone line services. Your phone supports these services, but you have to arrange for them through your telephone provider. Contact your provider for details.
- ◆ The pictures in this manual are for example only. Your phone may not look exactly like the pictures.

May be covered under one or more of the following U.S. patents:

5,801,466	5,825,161	5,864,619	5,893,034	5,912,968	5,915,227	5,929,598	5,930,720	5,960,358
5,987,330	6,044,281	6,070,082	6,076,052	6,125,277	6,253,088	6,314,278	6,321,068	6,418,209
6,618,015	6,714,630	6,782,098	6,788,920	6,788,953	6,839,550	6,889,184	6,901,271	6,907,094
6,914,940	6,940,867	6,953,118	7,023,176	7,030,819	7,146,160	7,203,307	7,206,403	7,310,398

Other patents pending.

© 2009 Uniden America Corp.  
Ft. Worth, TX 76155

Printed in Vietnam  
UNZZ01053BZ(0)