

# TOSHIBA

OWNER'S MANUAL

**3LCD DATA PROJECTOR**

---

**TLP560**

**TLP561**

*(WITH DOCUMENT IMAGING CAMERA)*

**TLP260**

**TLP261**

*(WITH DOCUMENT IMAGING CAMERA)*

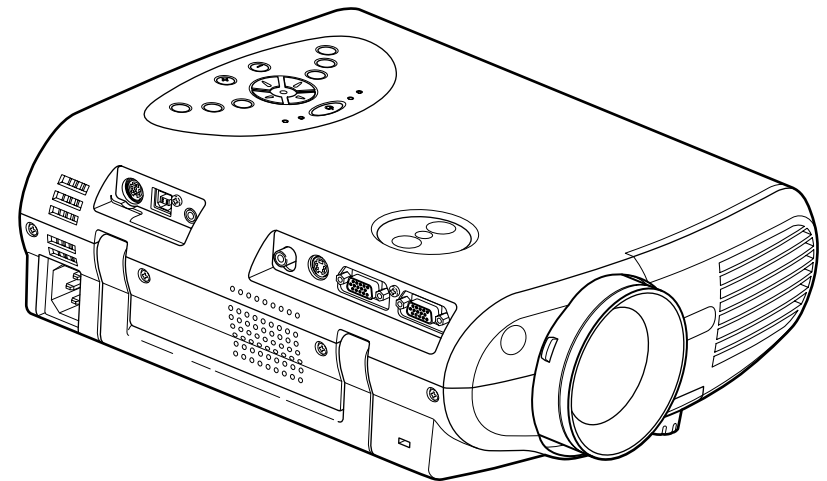

**TLP560/TLP260**

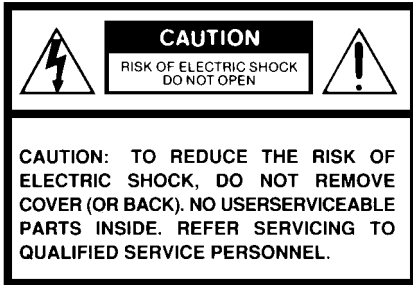

**WARNING: TO REDUCE THE RISK OF FIRE OR ELECTRIC SHOCK, DO NOT EXPOSE THIS APPLIANCE TO RAIN OR MOISTURE. DANGEROUS HIGH VOLTAGES ARE PRESENT INSIDE THE ENCLOSURE. DO NOT OPEN THE CABINET. REFER SERVICING TO QUALIFIED PERSONNEL ONLY.**



The lightning flash with arrowhead symbol, within an equilateral triangle, is intended to alert the user to the presence of uninsulated “dangerous voltage” within the product’s enclosure that may be of sufficient magnitude to constitute a risk of electric shock to persons.



The exclamation point within an equilateral triangle is intended to alert the user to the presence of important operating and maintenance (servicing) instructions in the literature accompanying the appliance.

# IMPORTANT PRECAUTIONS

## Save Original Packing Materials

The original shipping carton and packing materials will come in handy if you ever have to ship your LCD projector. For maximum protection, repack the set as it was originally packed at the factory.

## Avoid Volatile Liquid

Do not use volatile liquids, such as an insect spray, near the unit. Do not leave rubber or plastic products touching the unit for a long time. They will mar the finish.

## Moisture Condensation

Never operate this unit immediately after moving it from a cold location to a warm location. When the unit is exposed to such a change in temperature, moisture may condense on the crucial internal parts. To prevent the unit from possible damage, do not use the unit for at least 2 hours when there is an extreme or sudden change in temperature.

## Exemption Clauses

- Toshiba Corporation bears no responsibility in the case of damages arising from earthquakes, fire not liable to Toshiba Corporation, operating by third parties, other accidents, or use under abnormal conditions including erroneous or improper operation and other problems.
- Toshiba Corporation bears no responsibility for incidental damages (lost profit, work interruption, corruption or loss of the memory contents, etc.) arising from the use of or the inability to use this unit.
- Toshiba Corporation accepts no liability whatsoever for any damages arising from not having followed the descriptions in this Owner's Manual.
- Toshiba Corporation accepts no liability whatsoever for any damages arising from malfunctions arising from combination with equipment or software that is not related to Toshiba Corporation.

In the spaces provided below, record the Model and Serial No. located at the bottom of your LCD projector.

Model No. \_\_\_\_\_ Serial No. \_\_\_\_\_

Retain this information for future reference.

**CAUTION: PLEASE READ AND OBSERVE ALL WARNINGS AND INSTRUCTIONS GIVEN IN THIS OWNER'S MANUAL AND THOSE MARKED ON THE UNIT. RETAIN THIS BOOKLET FOR FUTURE REFERENCE.**

This set has been designed and manufactured to assure personal safety. Improper use can result in electric shock or fire hazard. The safeguards incorporated in this unit will protect you if you observe the following procedures for installation, use and servicing. This unit is fully transistorized and does not contain any parts that can be repaired by the user.

**DO NOT REMOVE THE CABINET COVER, OR YOU MAY BE EXPOSED TO DANGEROUS VOLTAGE. REFER SERVICING TO QUALIFIED SERVICE PERSONNEL ONLY.**

## 1. Read Owner's Manual

After unpacking this product, read the owner's manual carefully, and follow all the operating and other instructions.



## 2. Power Sources

This product should be operated only from the type of power source indicated on the marking label. If you are not sure of the type of power supply to your home, consult your product dealer or local power company. For products intended to operate from battery power, or other sources, refer to the operating instructions.



## 3. Source of Light

Do not look into the lens while the lamp is on. The strong light from the lamp may cause damage to your eyes or sight.

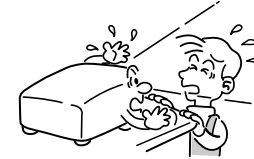

## 4. Ventilation

Openings in the cabinet are provided for ventilation and to ensure reliable operation of the product and to protect it from overheating, and these openings must not be blocked or covered. The openings should never be blocked by placing the product on a bed, sofa, rug or other similar surface. This product should not be placed in a built-in installation such as a bookcase or rack unless proper ventilation is provided or the manufacturer's instructions have been adhered to.



## 5. Heat

The product should be situated away from heat sources such as radiators, heat registers, stoves, or other products (including amplifiers) that produce heat.

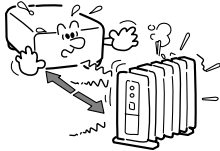

## 7. Cleaning

Unplug this product from the wall outlet before cleaning. Do not use liquid cleaners or aerosol cleaners. Use a damp cloth for cleaning.

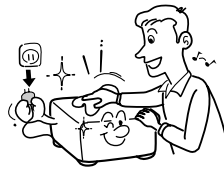

## 9. Overloading

Do not overload wall outlets; extension cords, or integral convenience receptacles as this can result in a risk of fire or electric shock.



## 6. Water and Moisture

Do not use this product near water – for example, near a bath tub, wash bowl, kitchen sink, or laundry tub; in a wet basement; or near a swimming pool and the like.

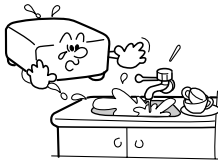

## 8. Power-Cord Protection

Power-supply cords should be routed so that they are not likely to be walked on or pinched by items placed upon or against them, paying particular attention to cords at plugs, convenience receptacles, and the point where they exit from the product.



## 10. Lightning

For added protection for this product during storm, or when it is left unattended and unused for long periods of time, unplug it from the wall outlet. This will prevent damage to the product due to lightning and power-line surges.

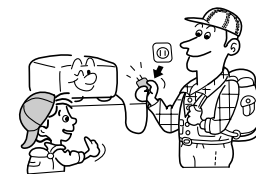

## 11. Object and Liquid Entry

Never push objects of any kind into this product through openings as they may touch dangerous voltage points or short-out parts that could result in a fire or electric shock. Never spill liquid of any kind on the product.



## 13. Stack Inhibited

Do not stack other equipment on this product or do not place this product on the other equipment. Top and bottom plates of this product develops heat and may give some undesirable damage to other unit.



## 12. Do not place the product vertically

Do not use the product in the upright position to project the pictures at the ceiling, or any other vertical positions. It may fall down and dangerous.

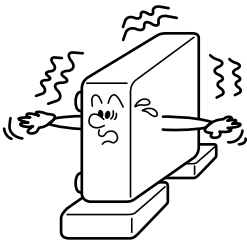

## 14. Attachments

Do not use attachments not recommended by the product manufacturer as they may cause hazards.



## 15. Accessories

Do not place this product on an unstable cart, stand, tripod, bracket, or table. The product may fall, causing serious injury to a child or adult, and serious damage to the product. Use only with a cart, stand, tripod, bracket, or table recommended by the manufacturer, or sold with the product. Any mounting of the product should follow the manufacturer's instructions, and should use a mounting accessory recommended by the manufacturer. A product and cart combination should be moved with care. Quick stops, excessive force, and uneven surfaces may cause the product and cart combination to overturn.

## 16. Damage Requiring Service

Unplug this product from the wall outlet and refer servicing to qualified service personnel under the following conditions:

- a) When the power-supply cord or plug is damaged.
- b) If liquid has been spilled, or objects have fallen into the product.
- c) If the product has been exposed to rain or water.
- d) If the product does not operate normally by following the operating instructions. Adjust only those controls that are covered by the operating instructions as an improper adjustment of other controls may result in damage and will often require extensive work by a qualified technician to restore the product to its normal operation.
- e) If the product has been dropped or damaged in any way.
- f) When the product exhibits a distinct change in performance – this indicates a need for service.

## 17. If glass components, including lens and lamp, should break, contact your dealer for repair service.

This product incorporates glass components, including a lens and a lamp. If such parts should break, please handle with care to avoid injury and contact your dealer for repair service. The broken pieces of glass may cause to injury.

In the unlikely event of the lamp rupturing, thoroughly clean the area around the projector and discard any edible items placed in that area.

## 18. Servicing

Do not attempt to service this product yourself as opening or removing covers may expose you to dangerous voltage or other hazards. Refer all servicing to qualified service personnel.



## 19. Replacement Parts

When replacement parts are required, be sure the service technician has used replacement parts specified by the manufacturer or have the same characteristics as the original part. Unauthorized substitutions may result in fire, electric shock, or other hazards. (Replacement of the lamp only should be made by users.)

## 20. Safety Check

Upon completion of any service or repairs to this product, ask the service technician to perform safety checks to determine that the product is in proper operating condition.

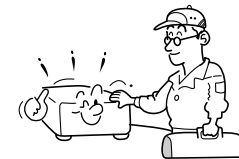

- 21. Do not get your hands between the camera arm and the main unit when setting the camera arm back in its original position.**

To avoid injury, be careful not to get your hands caught when setting the camera arm back in its original position. Families with children should be particularly careful.

- 23. Do not leave documents on the unit or near of the air exhaust for long periods of time.**

The heat could erase or discolor the letters on a thermal paper.

- 25. Do not look into the arm light while it is lit.**

The strong light may cause damage to your eyes or sight.

- 22. Do not carry by the camera arm.**

Do not carry the projector by the camera arm. Doing so can result in damage or injury.



- 24. Do not move the projector while the arm is still erect.**



Always store the arm back in position when moving the projector. Otherwise injury or damage may result.





# Power supply cord selection

If your line voltage is 220 to 240V, use one of the following types of cable.

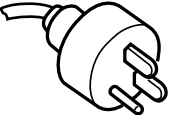
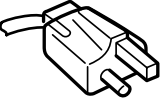
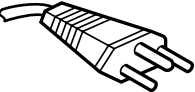
Plug configuration	Plug type	Line voltage
	EURO 240V 10 – 15A	220 – 240V
	UK 240V 6A	200 – 240V
	Australian 240V 10A	200 – 240V
	North American 240V 15A	200 – 240V
	Switzerland 240V 6A	200 – 240V

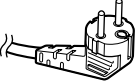
Plug configuration	Plug type	Line voltage
	EURO	220 – 240V

	UK	220 – 240V
---	----	------------

Use a 5A fuse which is approved by ASTA or BSI to BSI362.  
Always replace the fuse cover after changing the fuse.

## Before use

<i>SAFETY PRECAUTIONS</i> .....	2
<i>IMPORTANT PRECAUTIONS</i> .....	3
<i>IMPORTANT SAFETY INSTRUCTIONS</i> .....	4
<i>Power supply cord selection</i> .....	9
<i>Contents</i> .....	10
<i>Names of each part on the main unit</i> .....	11
<i>Names of each part on the remote control</i> .....	14
<i>Loading batteries</i> .....	15
<i>Remote control operation</i> .....	16

## Installation and connections

<i>Floor-mounted projector placement</i> .....	17
<i>Lens shift function</i> .....	20
<i>Projector placement angle adjustment (Foot adjuster)</i> ..	21
<i>Ceiling-mounted projector placement</i> .....	22
<i>Connecting a computer</i> .....	23
<i>Connecting video equipment</i> .....	24
<i>Projector operation control by a computer</i> .....	26
<i>How to use the output connector</i> .....	27

## Operations

<i>Projection on the screen</i> .....	28
<i>Turning the power off</i> .....	33
<i>Adjusting the picture automatically</i> .....	34
<i>Correcting the keystone distortion</i> .....	35
<i>Cutting off the picture and sound temporarily</i> .....	36
<i>Freezing the picture</i> .....	37
<i>Enlarging the picture size</i> .....	38
<i>Displaying PIP Sub-pictures</i> .....	39
<i>Displaying Information</i> .....	40
<i>Operating the presentation mode</i> .....	41

## Adjustments & Settings

<i>Operating the menu screen</i> .....	43
<i>GUIDE MENU adjustments and settings</i> .....	45
<i>FULL MENU adjustments and settings - Picture</i> .....	46
<i>FULL MENU adjustments - Position</i> .....	47
<i>FULL MENU adjustments - Color</i> .....	48
<i>FULL MENU adjustments and settings - Audio</i> .....	49
<i>FULL MENU adjustments and settings - Display</i> .....	50
<i>FULL MENU settings - Default setting</i> .....	51
<i>FULL MENU settings - Reset</i> .....	52
<i>PIP menu setting</i> .....	53

## Document imaging camera

<i>Part names (of the document imaging camera model) ...</i>	54
<i>Preparation of the document imaging camera</i> .....	55
<i>Picture projection with the document imaging camera</i> ..	56
<i>Locking the white balance</i> .....	59
<i>Correcting illuminated defects</i> .....	60

## Maintenance

<i>Trouble indications</i> .....	61
<i>Air filter cleaning</i> .....	62
<i>Lens and main unit cleaning</i> .....	64
<i>Lamp replacement</i> .....	65

## Others

<i>Before calling service personal</i> .....	67
<i>Pin assignment of COMPUTER IN, COMPUTER OUT connector</i> ....	69
<i>Applicable signal</i> .....	70
<i>Controlling the projector by using RS-232C</i> .....	72
<i>Specifications</i> .....	77

# Names of each part on the main unit

## CAUTION

Openings in the cabinet are provided for ventilation and to ensure reliable operation of the product and to protect it from overheating, and these openings must not be blocked or covered.

The explanation here is only for the model without the document imaging camera. For the model with the document imaging camera, refer to [54](#).

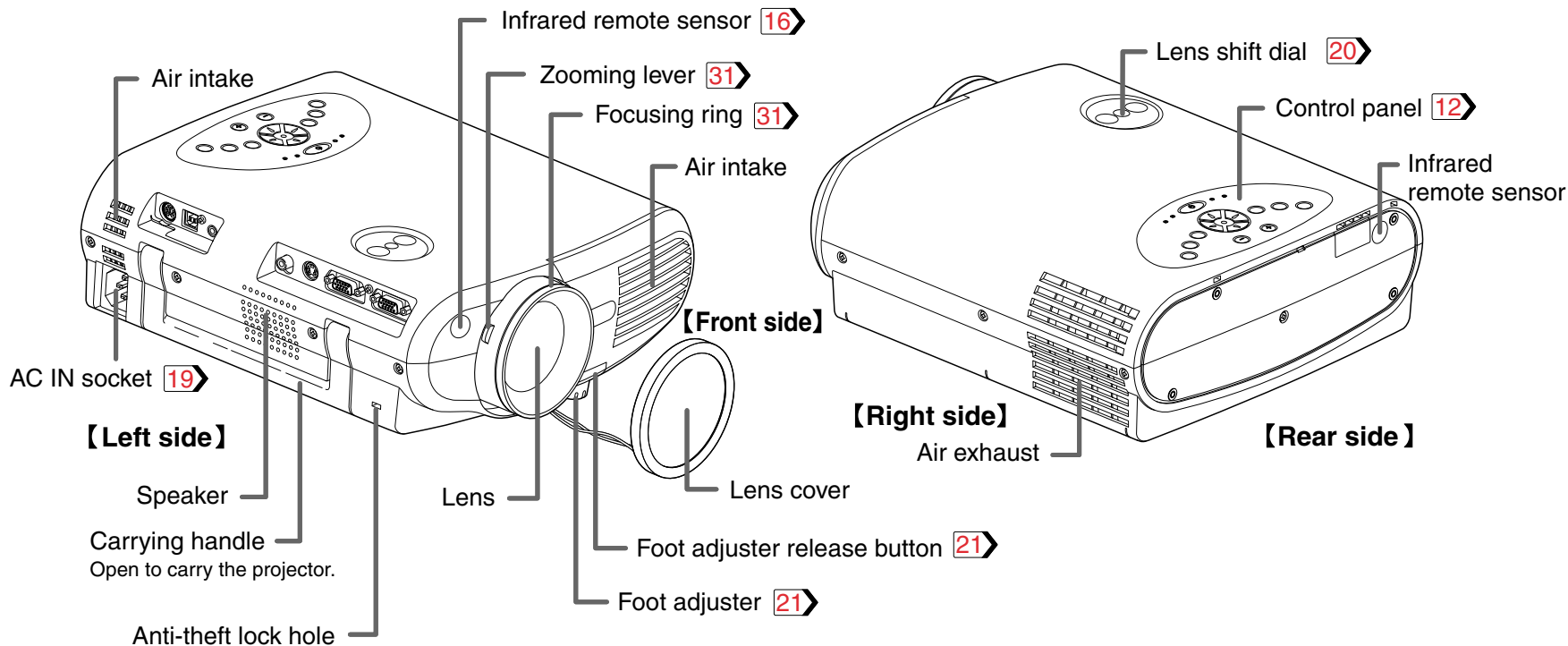

## Note

The air exhaust discharges high temperature air. Do not put anything around the air exhaust, otherwise it may deform due to the high temperature air.

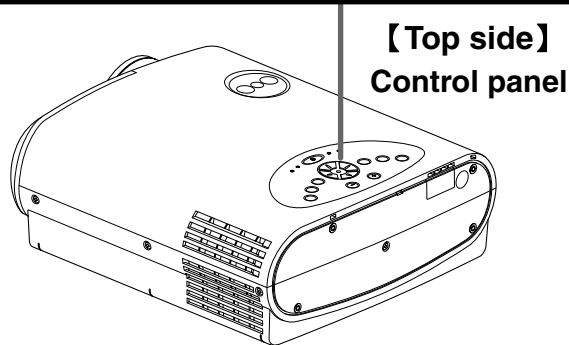
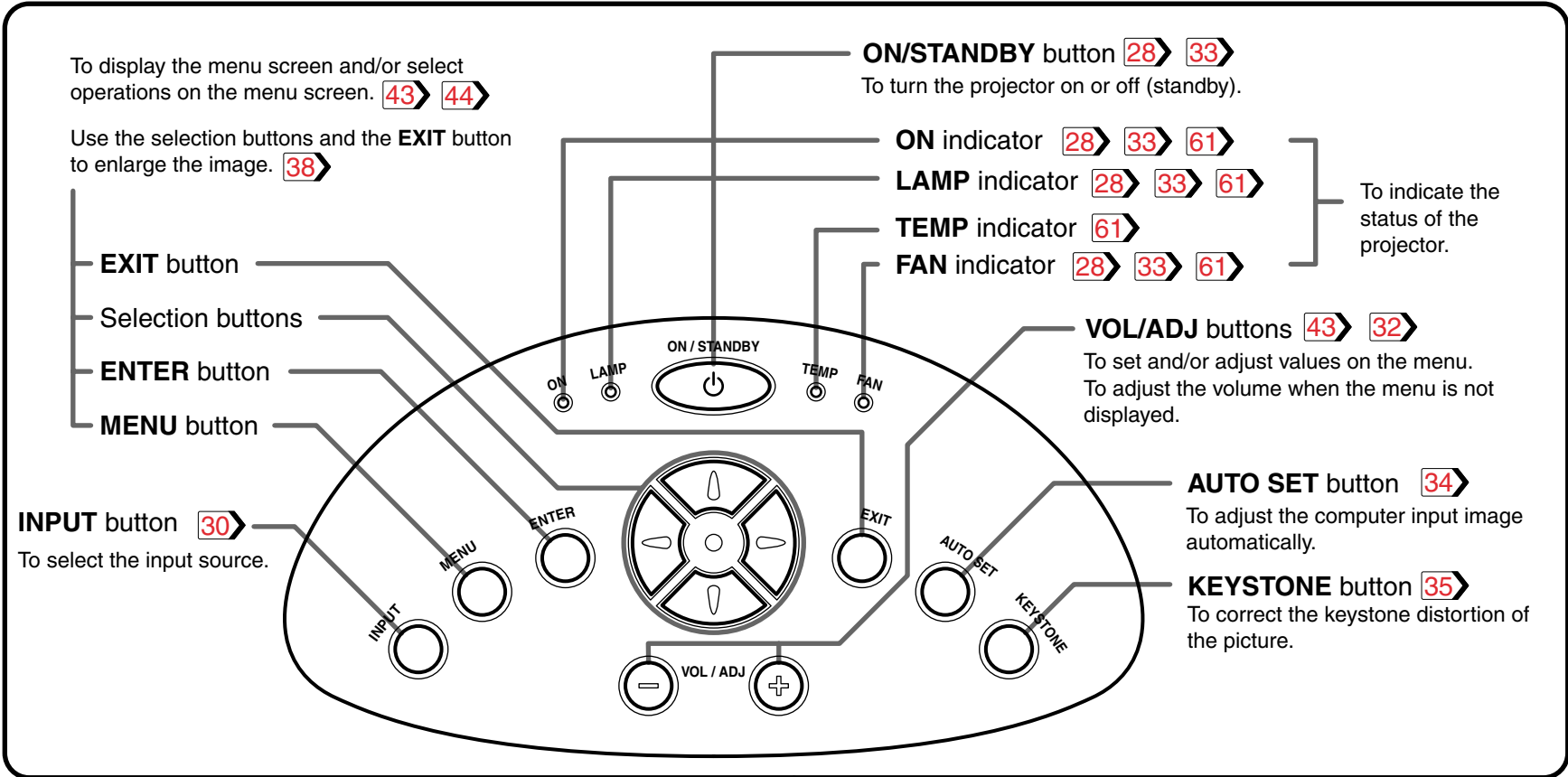

# Names of each part on the main unit (continued)

AUDIO IN jack **23** - **25**  
(Ø 3.5mm stereo mini-jack)  
To enter audio signal from a computer or a video equipment.

USB connector **41**  
To connect to a USB connector of a computer when using the presentation mode.

CONTROL connector **26** **72**  
(RS-232C connector)  
To connect a computer to control the projector.

VIDEO IN jack **24**  
To enter video signal from a video equipment, etc.

S-VIDEO IN connector **24**  
To enter S-Video signal from video equipment, etc.

COMPUTER OUT connector **27**  
To connect a monitor, etc.

COMPUTER IN connector **23** **25**  
To enter RGB signal from a computer, etc. or component video signal (Y/P<sub>B</sub>/P<sub>R</sub> Signal) from a video equipment.

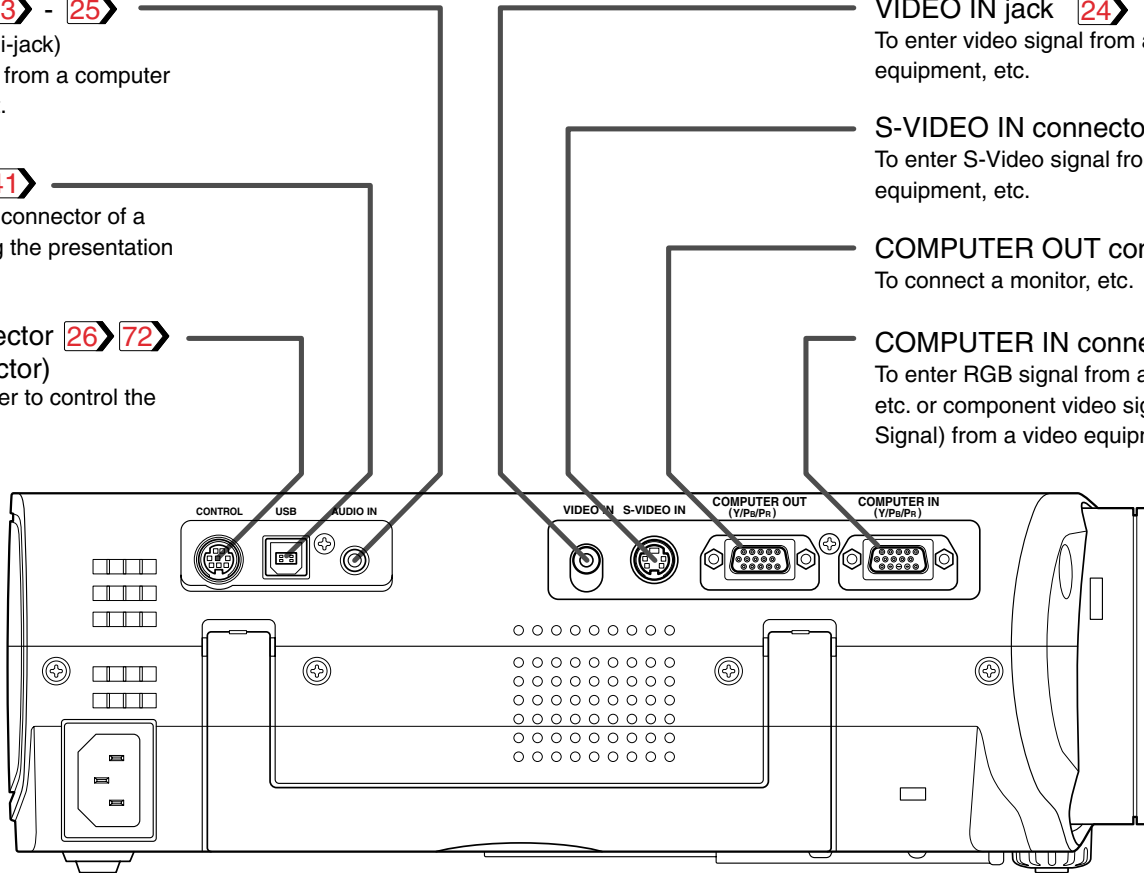

**【Left side】**

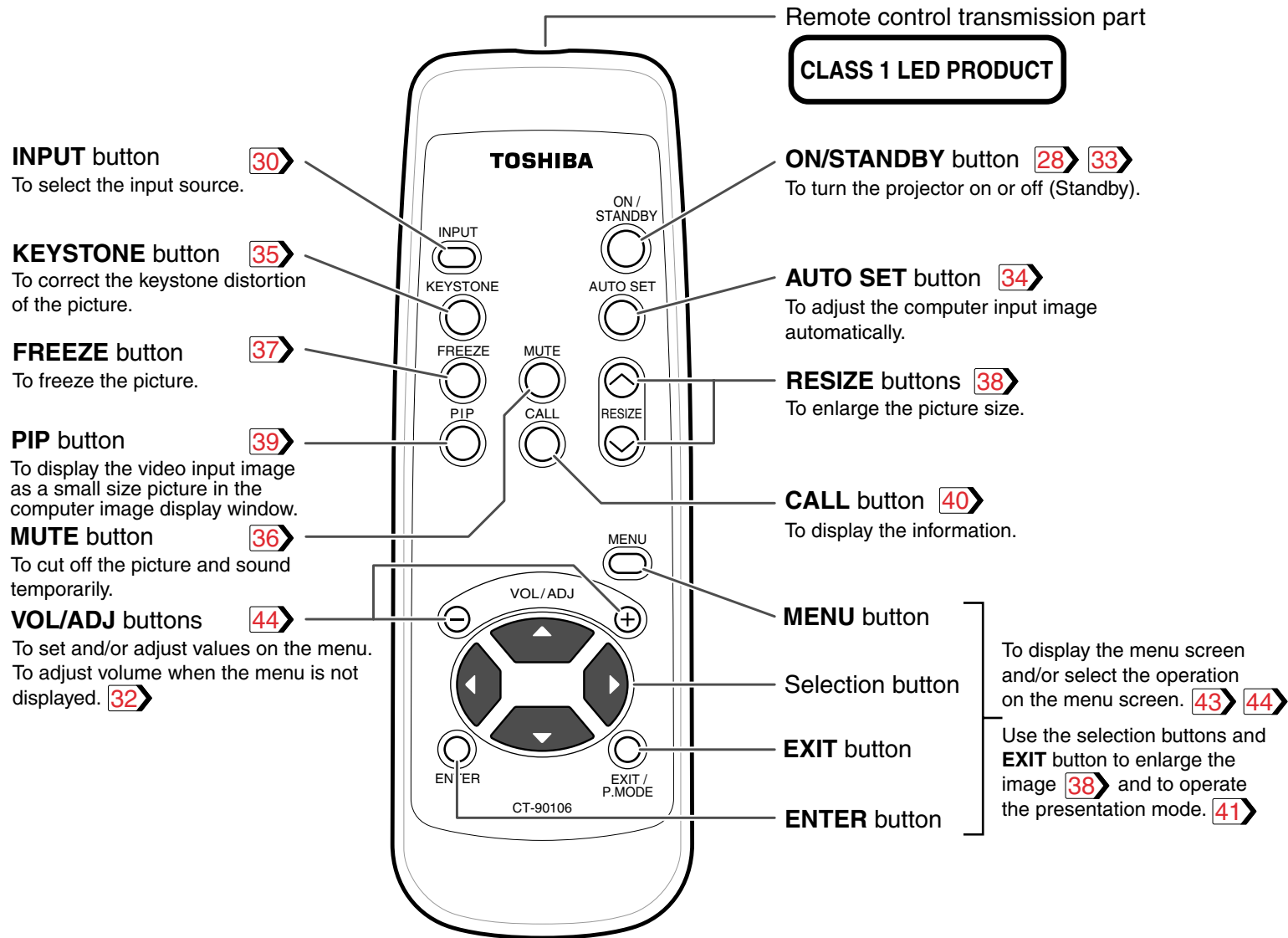

## Notes

Using batteries incorrectly can cause them to leak or burst. Strictly observe the following.

- Install the batteries with their + and – ends facing correctly.
- Do not charge, heat, disassemble, or short the batteries or throw them into a fire.
- Do not leave any exhausted batteries in the remote control.
- Do not mix different types of batteries or new and old batteries.
- When you will not be using the remote control for a prolonged period, take the batteries out of the remote control.
- When the remote control stops working or only works at very close range, replace all the batteries with new ones.
- When replacing the batteries, use longer life alkaline batteries.
- If a battery has leaked, carefully wipe off any residue inside the battery case before loading new batteries.

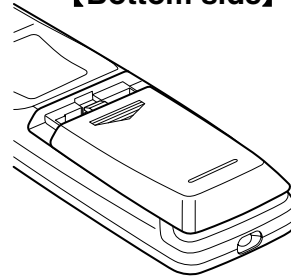
**1****【Bottom side】****Open the cover.****2****Install the batteries.**

Make sure that the +/- polarities match the illustration in the compartment.

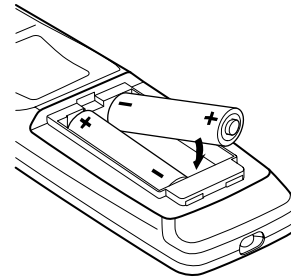
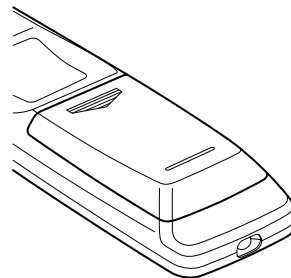
**3****Attach the cover.**

# Remote control operation

Point the remote control at the infrared remote sensor and press a button.

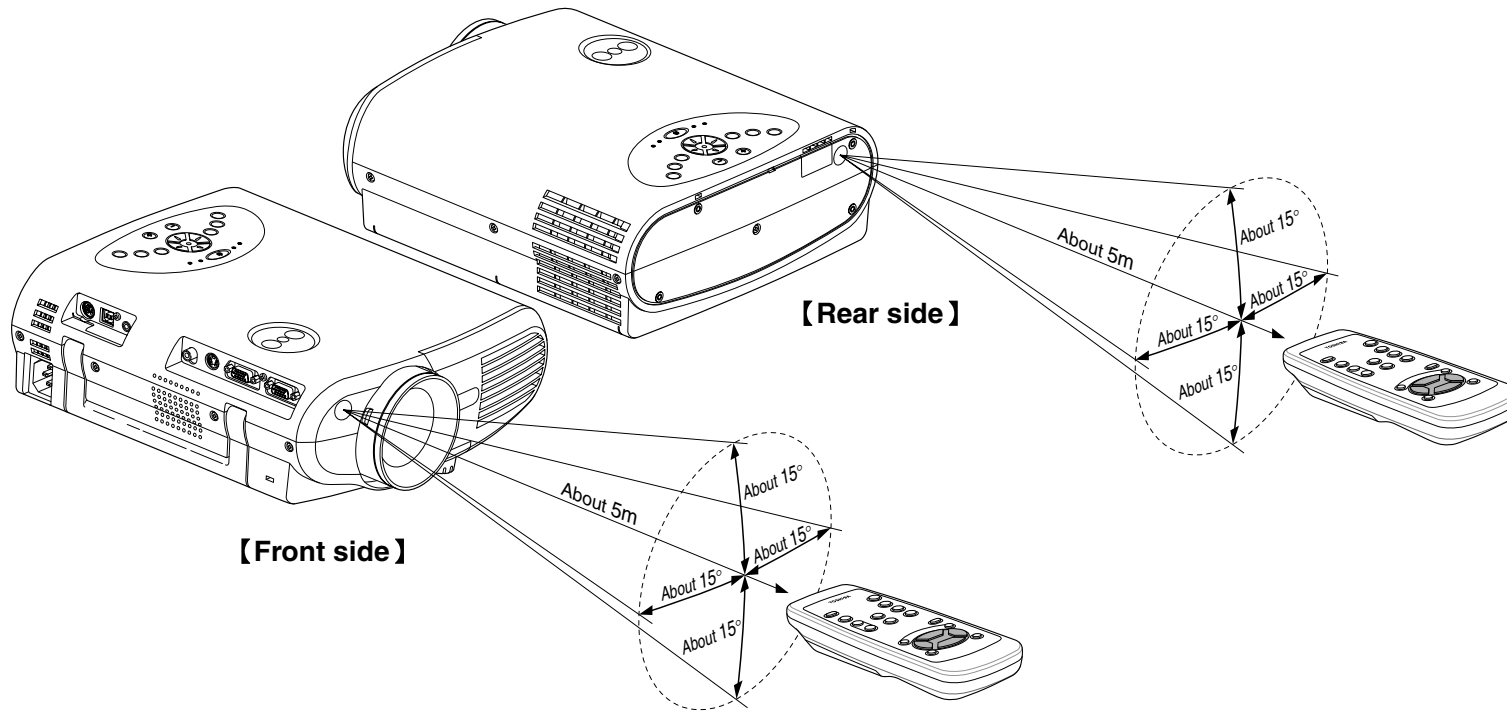

## Notes

- The remote control may not operate when there is sunlight or other strong light such as a fluorescent lamp shining on the projector's remote sensor.
- Operate the remote control from a position where the remote sensor is visible.
- Do not drop the remote control or otherwise jolt it.
- Keep the remote control out of locations with excessively high temperature or humidity.
- Do not get water on the remote control or place wet objects on it.
- Do not disassemble the remote control.
- Under unusual circumstances the remote control may not operate well due to the location being used or the surroundings. At such times, change the direction of the remote control to the projector and retry the operation.



# Floor-mounted projector placement

There are two ways to place the floor-mounted projector.

When the projector is mounted in the rear projection mode, the picture is reversed. Set the “Projection mode” (on the menu screen) according to the projection method. [51](#) At shipping from factory, it is set for the Floor-mounted front projection.

For the ceiling-mounted projector placement, refer to the page [22](#).

## Floor-mounted front projection

Viewing a picture projected on the front of the screen from a floor installation.

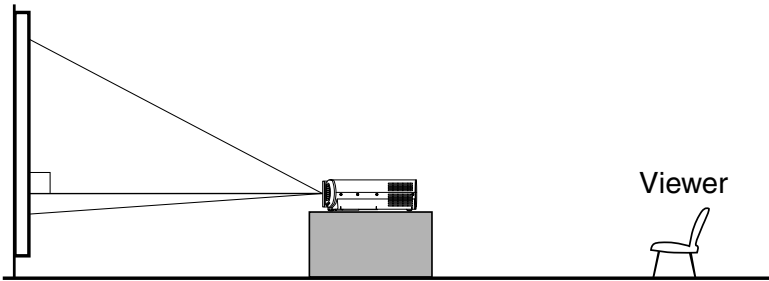

## Floor-mounted rear projection

Viewing a picture projected through the back of the screen from a floor installation.

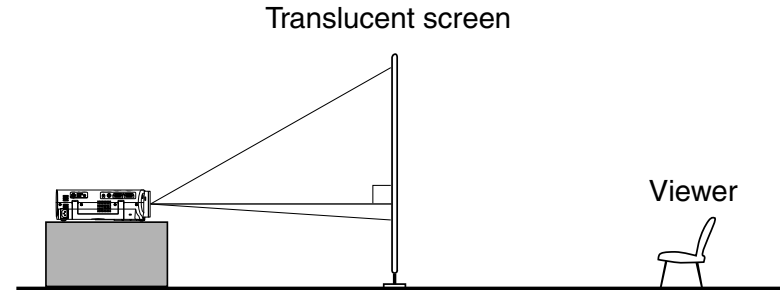

**1 Place the projector on a steady, level surface such as a table.**  
 To obtain proper screen projection, place the projector so that the light beam hits the screen squarely.

Top view

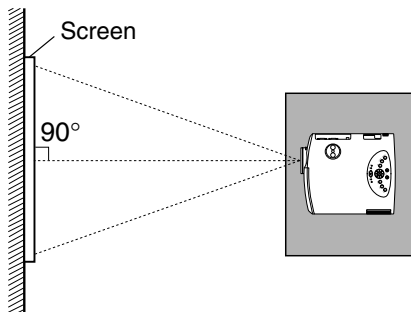

Point the lens straight at the center of the screen as above.

Side view

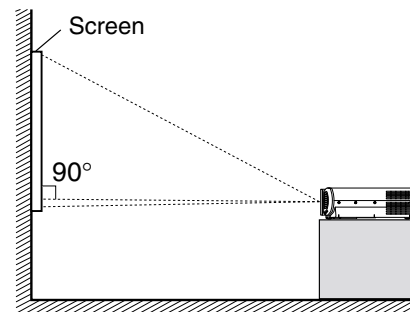

Place the projector horizontally so that the projecting light hits the screen squarely.

**2 Determine the screen size projected on the screen.**  
 The projection size depends on the distance between the lens and the screen.  
 Adjust the projection size by changing the distances as shown below.

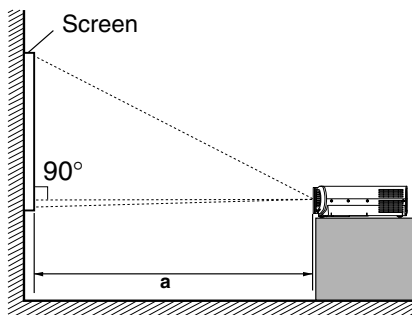

$$a \text{ (min.)} = \frac{\text{Projection size} \times 20.32 - 31}{1000}$$

$$a \text{ (max.)} = \frac{\text{Projection size} \times 24.38 - 32}{1000}$$

a: Distance between the lens and the screen (m)  
 Limit: 0.70m < a < 3.63m

• The values are approximations.

Projection size (inches)	a (m)	
	Minimum (At maximum zoom)	Maximum (At minimum zoom)
30	–	0.70
36	0.70	0.85
50	0.98	1.19
80	1.59	1.92
100	2.00	2.41
120	2.41	2.89
150	3.02	3.63
180	3.63	–

**Note**

You can adjust the vertical projection position with the lens shift dial. **20**

Continued

## 3 Connect the power cord.

- Insert one end into the AC IN socket on the projector.
- Insert the other end into a wall outlet.

The three indicators, TEMP, LAMP, and ON, light in green for several seconds and then the ON indicator lights in orange and the projector turns to the standby mode.

Do not perform any operations while the three indicators are lit green.

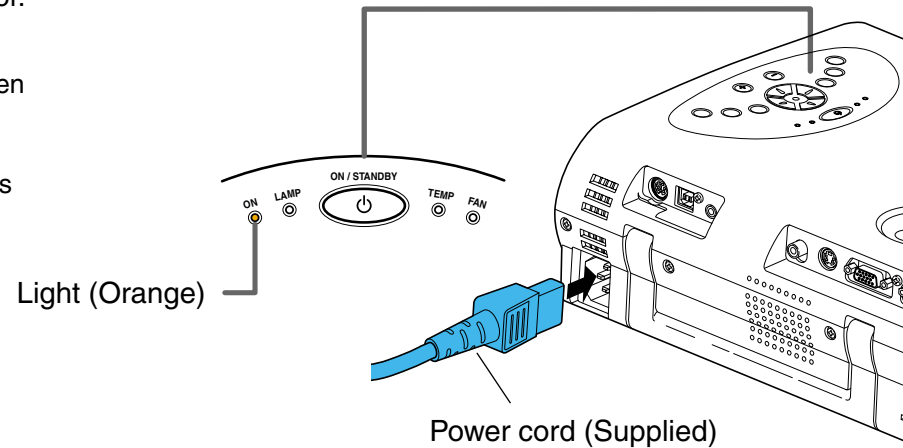

## 4 Take off the lens cover.

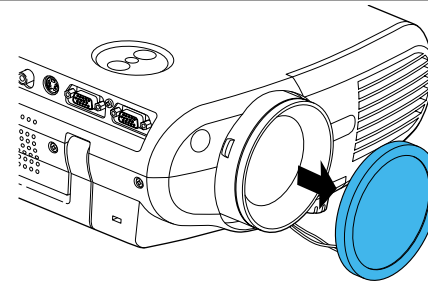

### Notes

- When the projector is moved from a cold location to a warm location, or when the ambient temperature in the projection room has risen suddenly, moisture may condense on the lens or the internal optical section to blur the projected pictures. In such a case, leave the projector for an adequate time (1 to 2 hours, depending on the room's condition) before using it, so it adjusts to the ambient temperature.
- If the screen is exposed to direct sunlight or other strong light, the projected picture will become too faint to see. Shut out the light with curtains or by other means.
- If the screen and the projector are not installed properly, the projected picture may be distorted.

# Lens shift function

When turning the lens shift dial, the lens moves to upward or downward and the projection position on the screen is to be adjusted. At shipping from factory, it is set to the state turned clockwise fully (the highest projection position). Refer to “Projection on the screen” [28](#), and adjust it after projecting a picture.

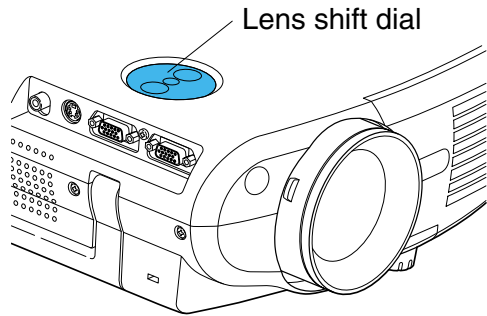

When the lens shift dial is turned counterclockwise fully, the projection position becomes the lowest.

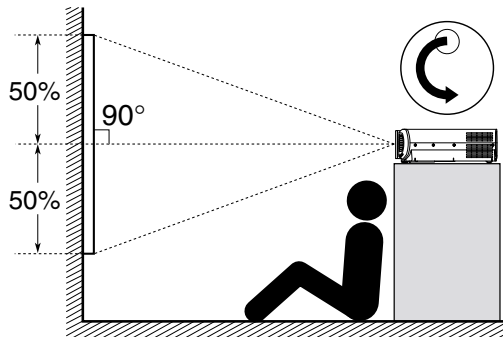

When the lens shift dial is turned clockwise fully, the projection position becomes the highest. At shipping from factory, the lens shift dial is set to this state.

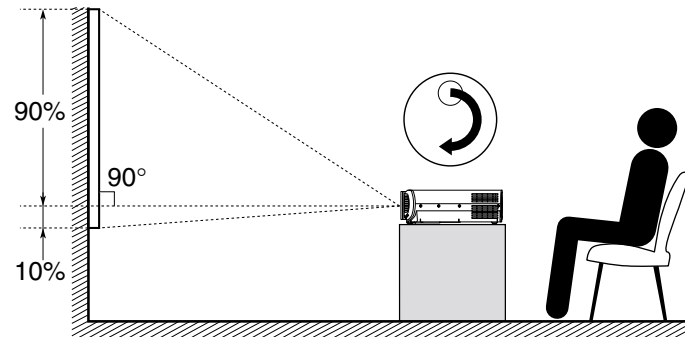

## Notes

- Never give strong force to the lens shift dial as this may cause malfunction.
- At the ceiling-mounted projector placement [22](#), the relation between the moving direction of the projection position and the turning direction of the lens shift dial becomes contrary from the case of the floor-mounted projector placement.

# Projector placement angle adjustment (Foot adjuster)

The tilt of the projector can be adjusted using the foot adjuster. Adjust this when the highest position by the lens shift dial [20](#) is insufficient. Refer to “Projection on the screen” [28](#), and adjust the foot adjuster after projecting a picture.

1

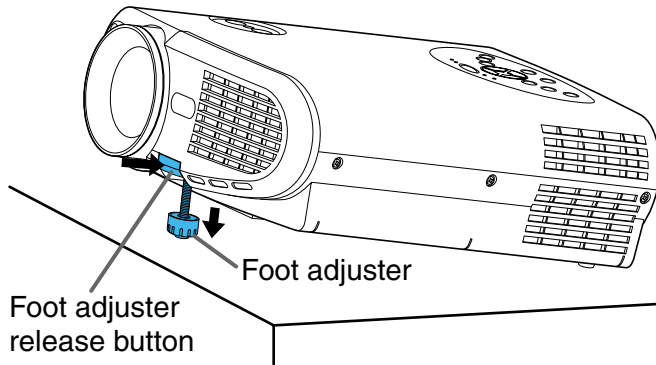

**Lift the front of the projector until the desired tilt angle is obtained and hold down the foot adjuster release button.**

The foot adjuster will extend.  
Release the button to lock in position.

2

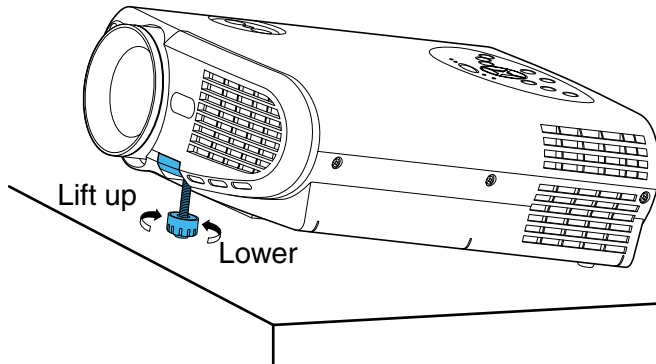

**Turn the foot adjuster to make fine adjustment to the height.**

Turn clockwise to lift up.  
Turn counterclockwise to lower.

## Notes

- To put the foot adjuster back, hold down the foot adjuster release button and lower the front slowly.
- Be sure to hold the projector when putting the foot adjuster back so as not to let the front fall on your fingers.
- Do not tilt the projector at an angle exceeding the range adjustable by the foot adjusters, since the life duration of the lamp may be shortened.

## CAUTION

When a ceiling mount is required, please consult with the dealer.

### Ceiling-mounted front projection

Viewing a picture projected on the front of the screen from a ceiling installation.

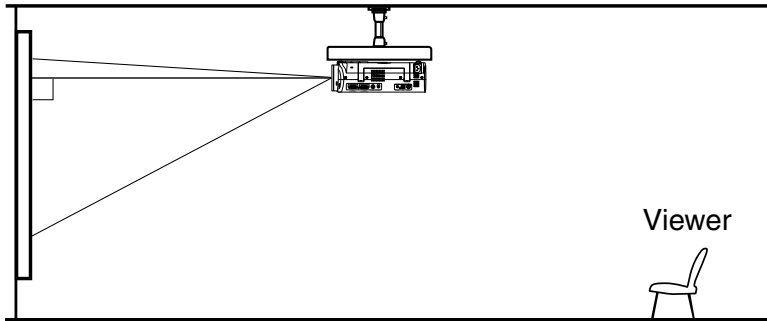

### Ceiling-mounted rear projection

Viewing a picture projected through the back of the screen from a ceiling installation.

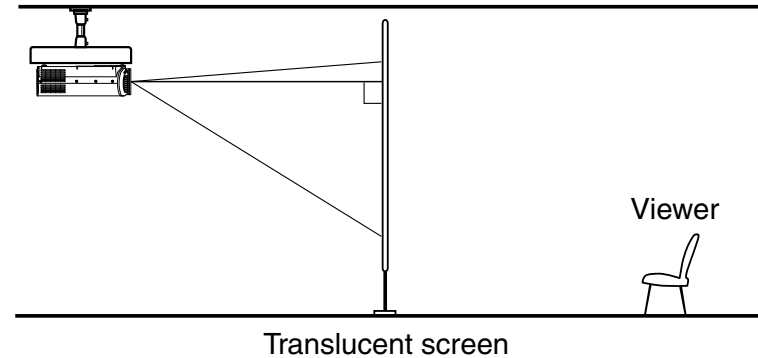

Perform the “Projection mode” setting on the menu screen for the projection method. [51](#)

## Note

The relation between the projection size and the distance to the screen is the same as that of the floor-mounted projection mode [18](#).

# Connecting a computer

You can project the picture from the computer.

Check that the power supplies for the projector and for the computer are off before connecting the cables.

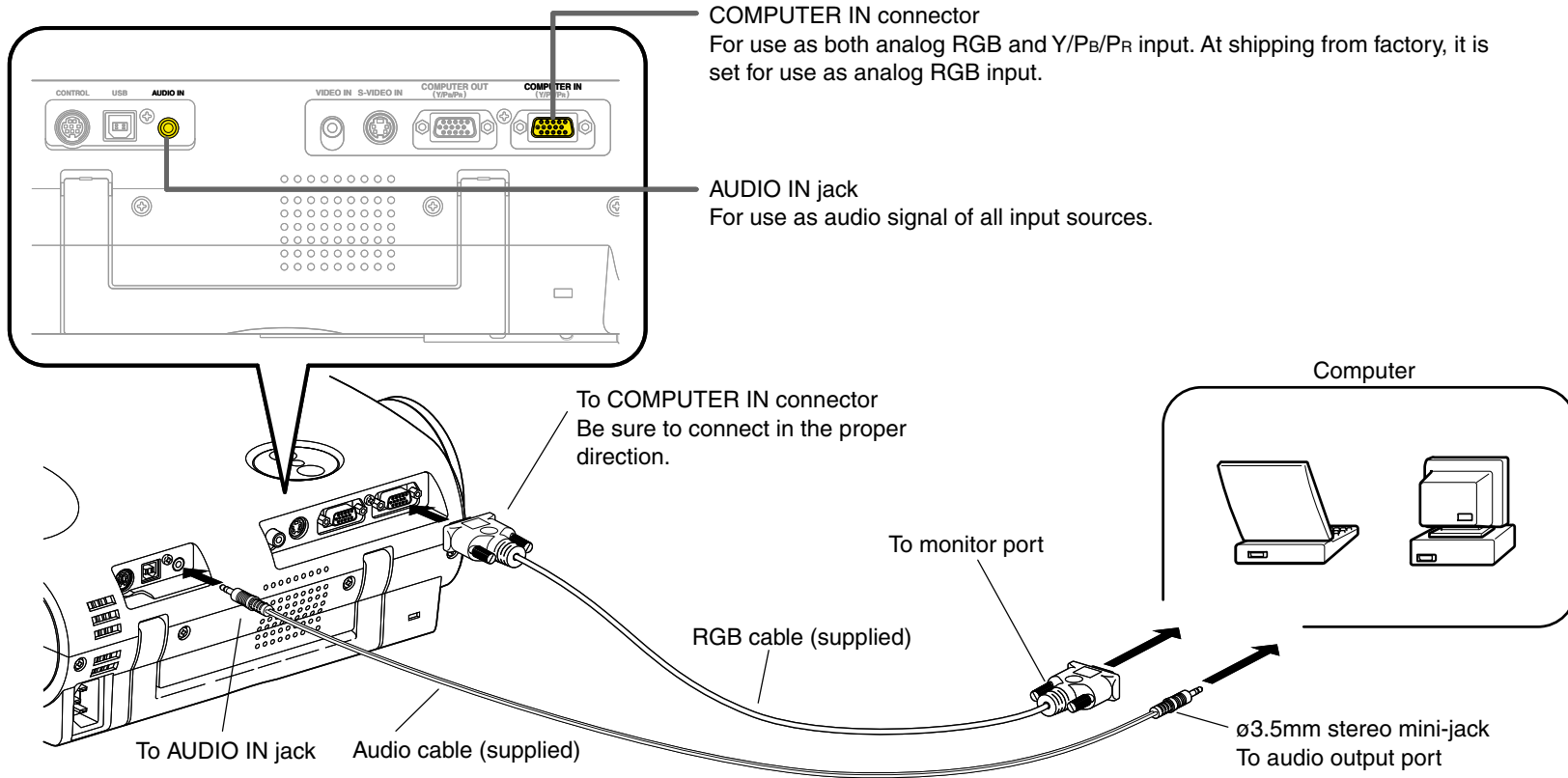

## Notes

- The projector cannot be connected to a computer without an analog RGB connector. For details, refer to the computer manual.
- You may not be able to connect some computers to the projector. For details, consult the dealer.
- When connecting to a Macintosh computer, some models may need a Mac adapter for connection.
- Some computers may have output modes which are not compatible with this projector. Check the compatibility of the connectors, signal levels, timing, resolutions, etc.

# Connecting video equipment

You can project the picture from video equipment.

Check that the power supplies for the projector and for the video equipment are off before connecting the cables.

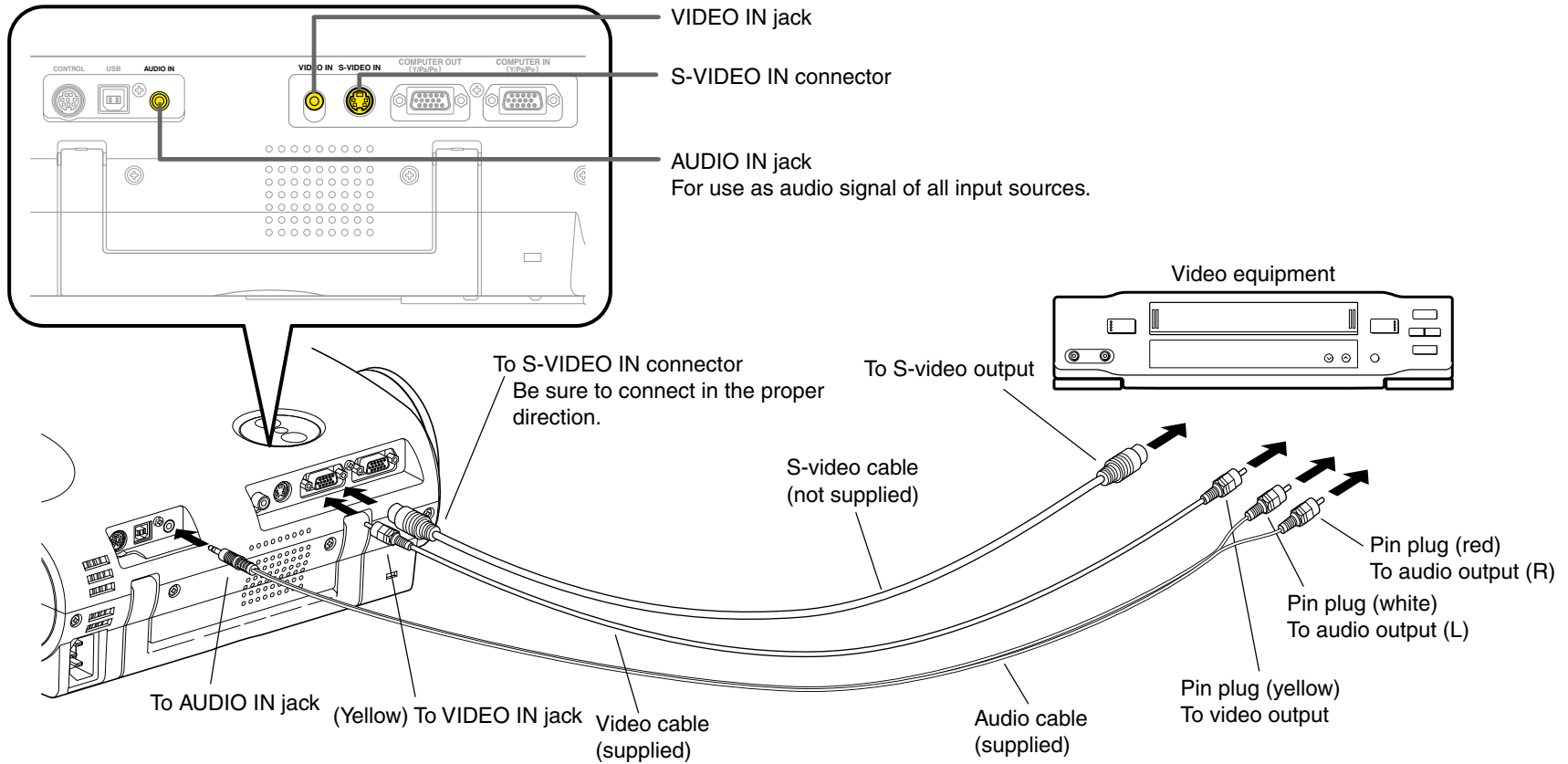

**Note**  
The S-VIDEO IN connector and VIDEO IN jack can be used independently, but the audio input jack is used for all input sources.



# Connecting video equipment (continued)

You can project the picture from video equipment with component video output jack.  
Check that the power supplies for the projector and for the video equipment are off before connecting the cables.

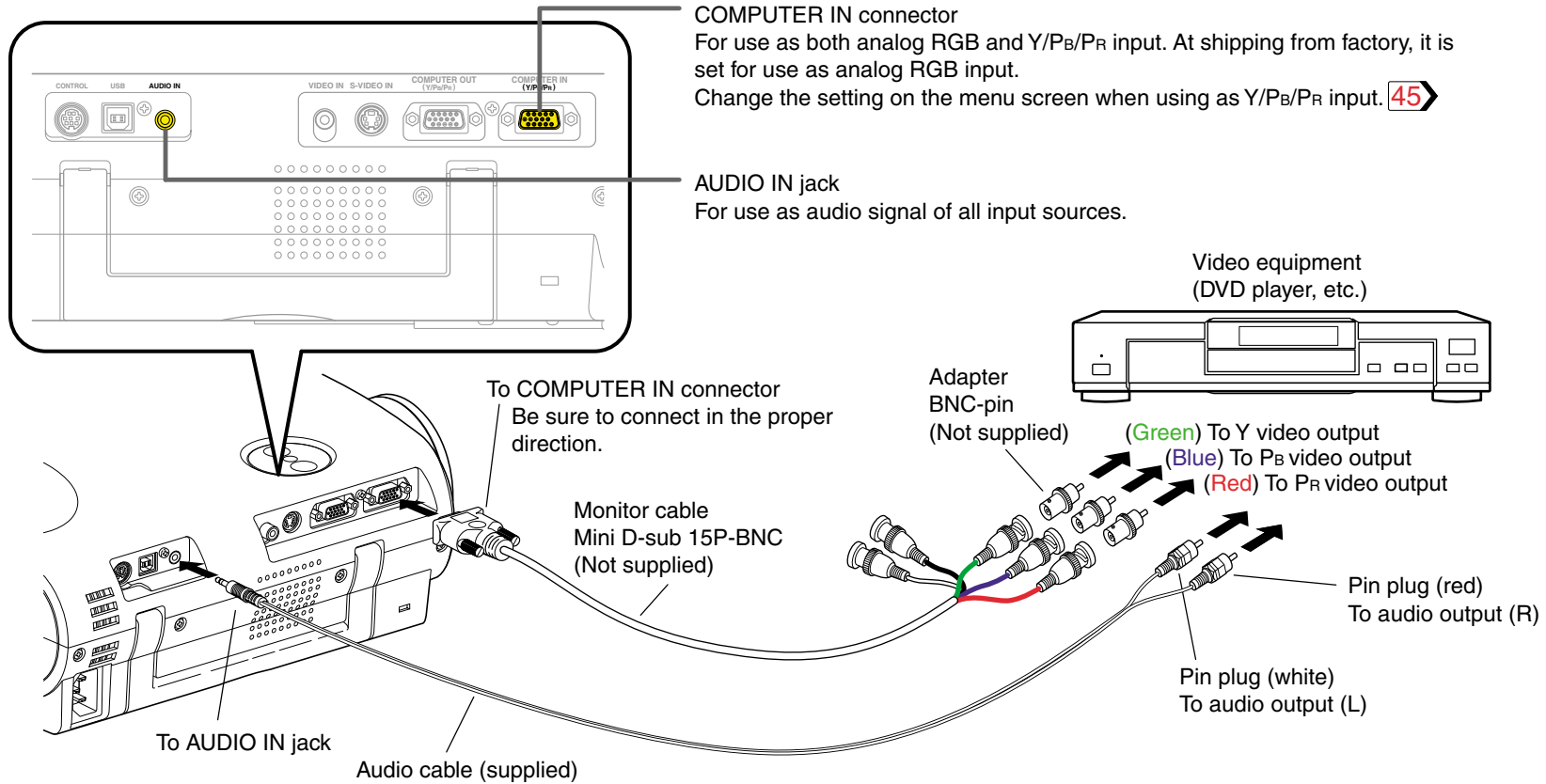

# Projector operation control by a computer

You can control the projector by a computer connected with the control cable supplied. **72**➤  
Check that the power supplies for the projector and for the computer are off before connecting the cables.

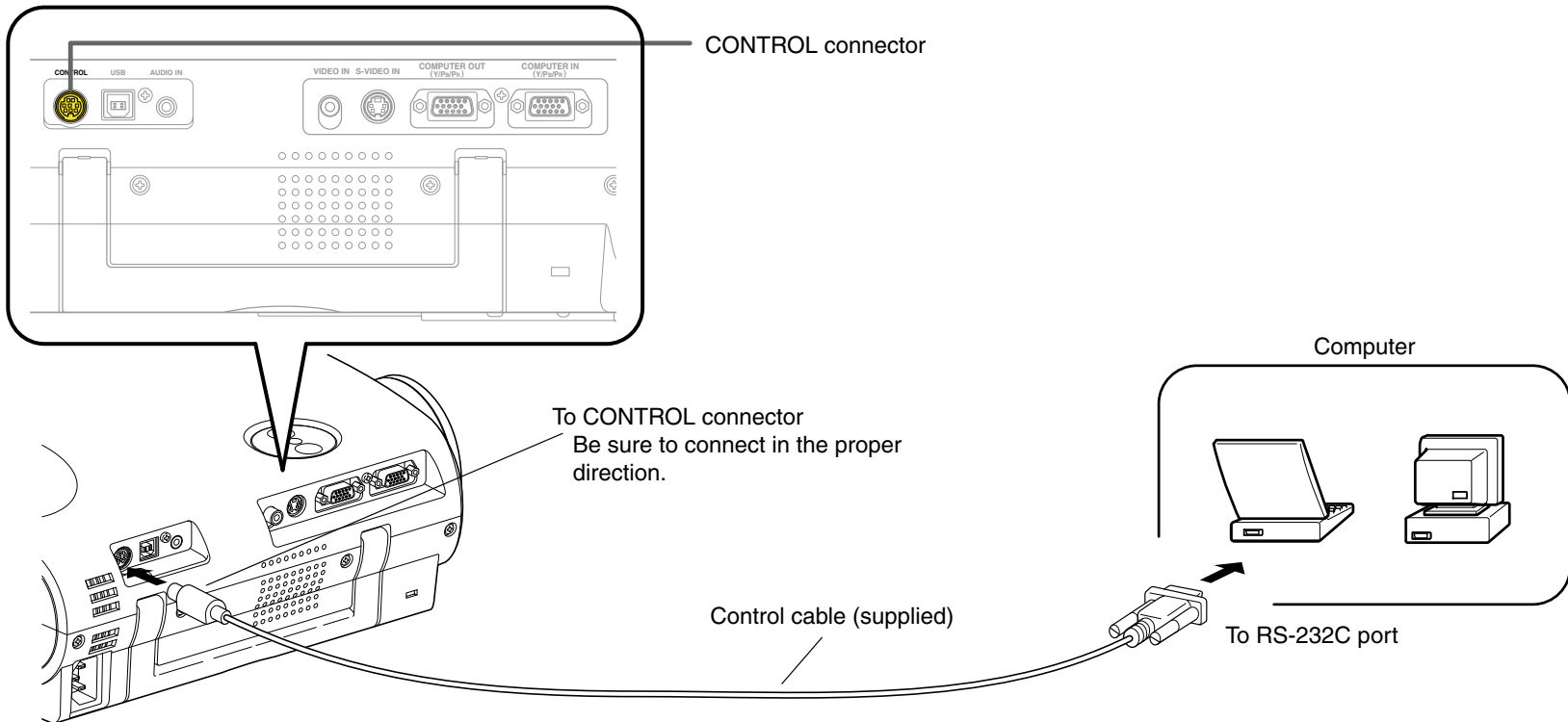

**Note**  
Do not connect any cable other than the exclusive one supplied.

# How to use the output connector

You can output analog RGB signal to a computer monitor, etc.

Check that the power supplies for the projector and for the computer are off before connecting the cables.

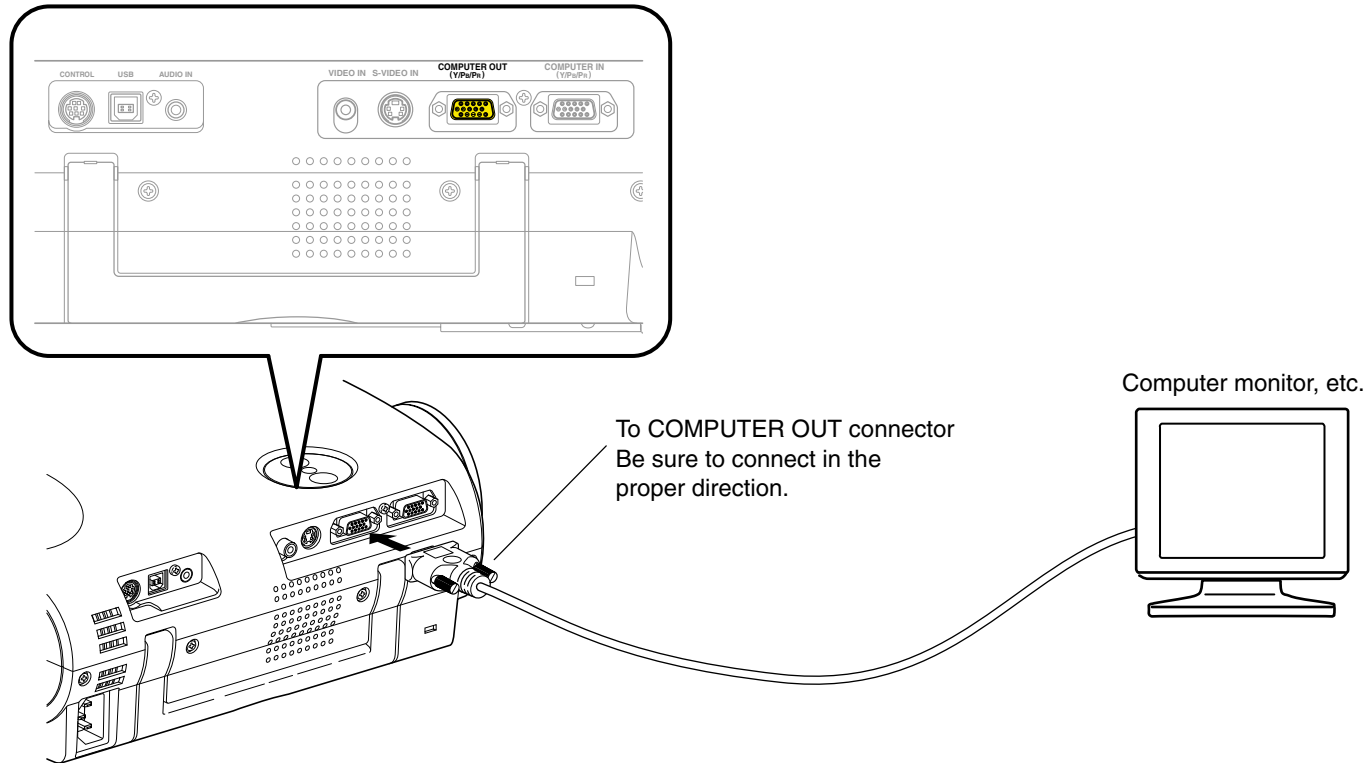

## Notes

- The analog RGB signals or Y/Pb/Pr signals of the COMPUTER IN connector are output from the COMPUTER OUT connector.
- Signals are output from the COMPUTER OUT connector even when in the standby mode.
- A general computer monitor may not display a normal picture with Y/Pb/Pr signals.

**CAUTION** – Do not look into the projection lens while operating the projector.

### Remote control

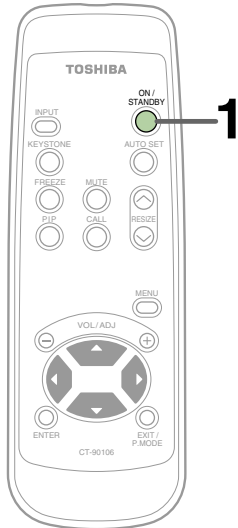

### Control panel (Main unit side)

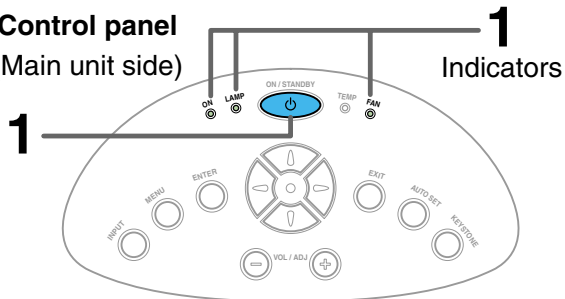

### Preparation

- 1 Install and connect the projector properly.
- 2 Take off the lens cover.

1

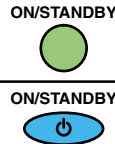

### Press ON/STANDBY.

The projector turns on and the ON, LAMP and FAN indicators light in green.  
(The LAMP indicator blinks while the lamp is warming up.)

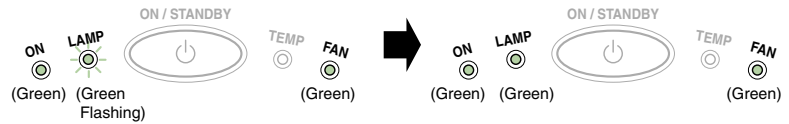

The lamp lights and the start up display appears.

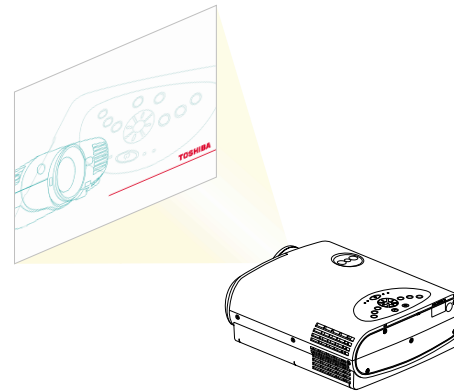

### Notes

- The startup screen disappears when you push the **EXIT** button or wait for a while. You can also set the startup screen not to be displayed on the menu screen. [51](#)
- When a projector is used for the first time, the language selection menu is displayed after the startup screen disappears. Set it up with procedures 2 and 3 on the next page.

Remote control



2,3

Control panel  
(Main unit side)

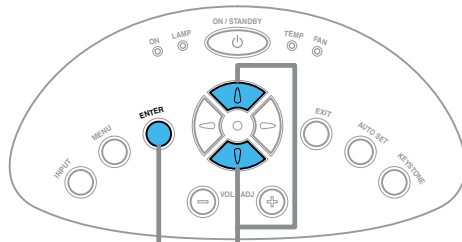

2,3 2

When a projector is used for the first time, the language selection menu, which is to select a language for displaying menus or messages, is displayed. Select a desired language. (At shipping from factory, it is set to English.)

2



**Select a desired language with the selection buttons (▲/▼), and press ENTER.**

A menu confirming the selection result is displayed in the selected language.

3



**Press ENTER to confirm.**

Press EXIT to return to step 2 if you want to re-select a language.

### Notes

- The language selection menu will not be displayed on the second and subsequent times you turn on the power. However, if “Reset all” [52](#) is executed, the language selection menu will be displayed when the power is turned on next.
- The language can also be selected on the menu screen. [50](#)
- This Owner’s manual is described on the supposition that English was selected.

4



**Turn on the connected equipment and put it in playback mode.**



Select “Cancel” or install driver contained in the supplied CD-ROM, when the dialog box of the Add New Hardware Wizard screen appears on the computer when connecting a computer. (The supplied CD-ROM contains a driver information file named TOSHIBA\_TLP.inf. Click the Browse button of the dialog box to find and designate this file.)

### Remote control

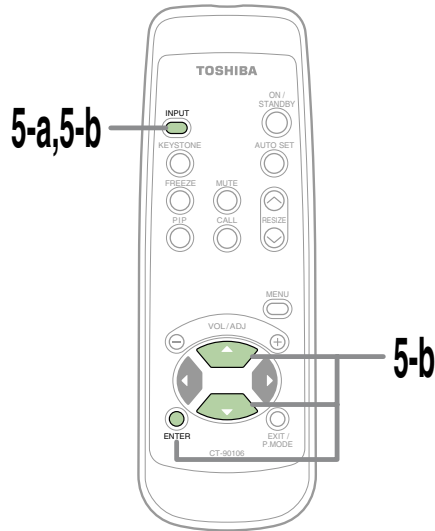

### Control panel (Main unit side)

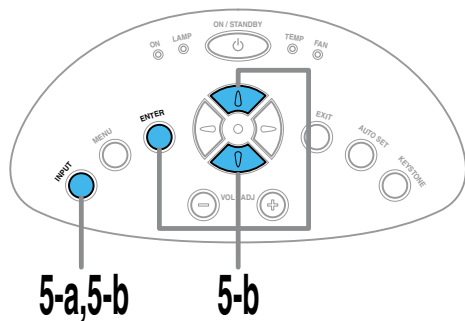

Select the input source to project.

There are two kinds of methods as follows (5-a and 5-b.)

## 5-a

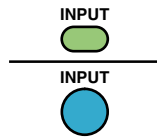

### Select the input source by pressing INPUT repeatedly.

At shipping from factory, "Analog RGB" connected to COMPUTER IN connector or "Video" connected to VIDEO IN Jack can be selected. (You can select "Camera" when using the model with a document imaging camera.)

The icon and the name of the selected input source appear on the screen.

### Note

The types of input sources selected when the INPUT button is pressed repeatedly can be set from the menu screen. [45](#)

## 5-b

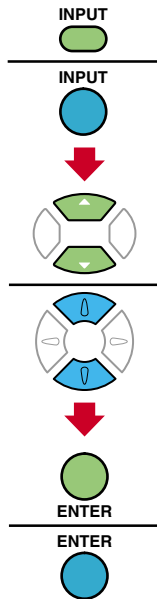

### Press INPUT and hold for two seconds.

The input source selection menu appears.

### Select the input source to project with the selection buttons (▲/▼).

Regardless of the contents of input source settings on the menu screen, all the input sources are displayed here for selection.

### Press ENTER.

A picture of the selected input source is projected.

When a sound signal source is also connected, sound is emitted from the speaker.

## Notes

(Signal sent from the computer)

- If you project an image from a computer with an LCD screen while monitoring the image on the computer, the image may not be projected properly, depending on the computer model. In this case, turn off the computer display. For details on controlling the computer display, etc., refer to the computer's manual and description on the software for the computer used.
- The TLP560/TLP561 projects an image by XGA signal (1024 x 768) in full screen. The image quality from a computer signal other than XGA may be inferior. It is recommended to set the external monitor connected to the computer to XGA mode (1024 x 768).
- The TLP260/TLP261 projects an image by SVGA signal (800 x 600) in full screen. The image quality of a computer signal except SVGA may deteriorate. It is recommended to set the external monitor connected to the computer to SVGA mode (800 x 600).
- The projector can be also applied to DDC2B (Display Data Channel 2B). If your computer is applied to the DDC, start up your computer after turning on the projector. If the order is reversed, the computer may not output any signal.

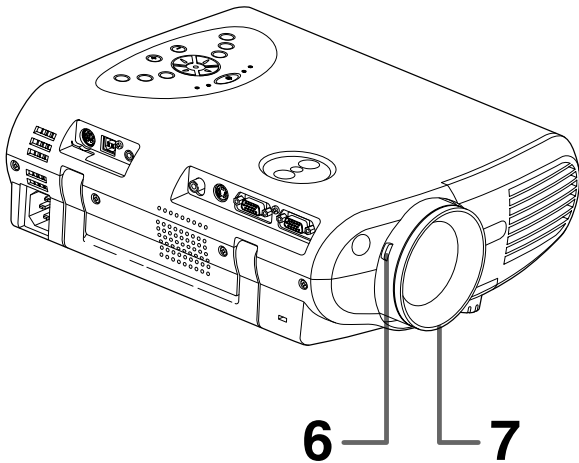

6

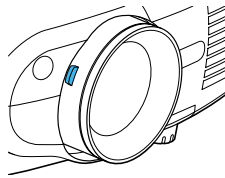

### Adjust the picture size by turning the zooming lever.

Turn to the right to enlarge the picture.  
Turn to the left to reduce the picture.

7

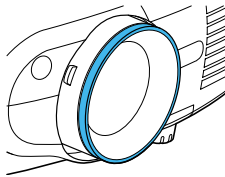

### Focus on the picture by turning the focusing ring.

A still picture is recommended for focusing.

## Remote control

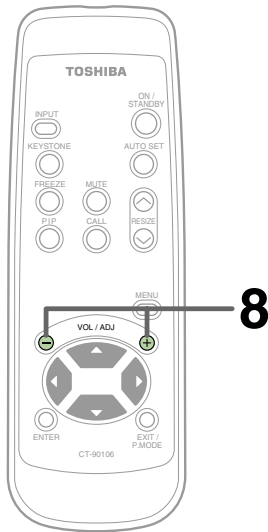

## Control panel (Main unit side)

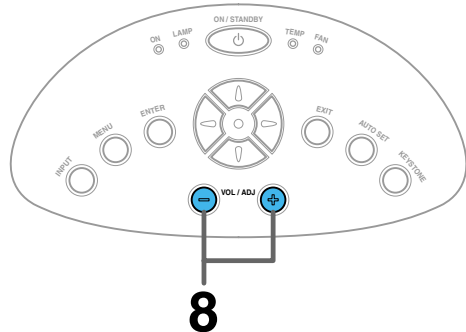

## 8

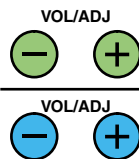

### Press VOL/ADJ (+/-) to adjust volume.

Press the (+) button to increase volume.

Press the (-) button to decrease volume.

### Notes

- To change the projecting angle, adjust the foot adjuster. [21](#)
- If the screen image suffers keystone distortion, press the **KEystone** button to adjust the distortion. [35](#)
- Due to lamp characteristics, flickers may occasionally occur in a picture. This is not malfunction of the unit.
- The lamp may rarely burst with a loud sound.
- The projector's liquid crystal panel is made using extremely advanced technology, but there may be black spots (pixels that do not light) or bright spots (pixels that are constantly lit) on the panel. Please note that these are not malfunctions.
- When trying to press a button whose operation is not available, the icon appears.
- When supplying the signal not compatible with the projector, the icon appears.
- When signals are not input from the input source, the **OFF** icon appears.
- The projector may stop operating if the surrounding temperature is too high or if the air filter is clogged with dust. [61](#)

### About the LCD Panel

The life of the LCD panel is limited.

Take care over the points below so as to use the panel for years.

- To prolong the life of this panel, never fail to turn the power off when the panel is not in use and make sure that the lamp has gone out. The state of the lamp being extinguished helps enhance the effect of energy saving.
- If the air filter is stained and is clogged up, the main unit inner temperature rises. As a result, the life of the LCD is shortened and a malfunction may also occur. Clean the air filter from time to time [62](#) and replace it regularly. It is recommended that this replacement be done at the time of replacing a lamp. (Ask a dealer where the unit was purchased or your nearby service station about an air filter for replacement.)



### Remote control

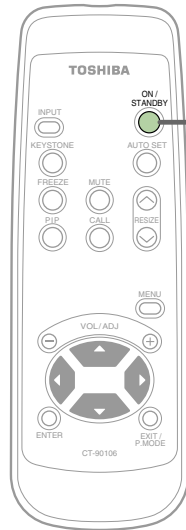

### Control panel (Main unit side)

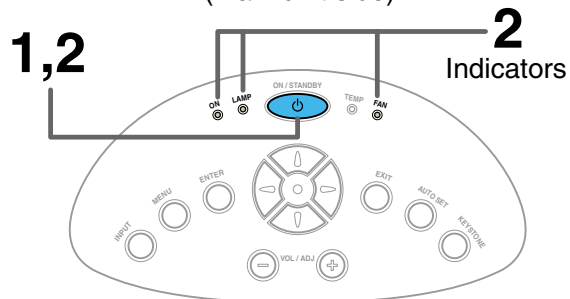

# 1

ON/STANDBY

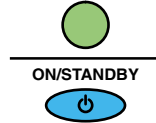

## Press ON/STANDBY after using the projector.

An instruction message for turning the power off appears on the screen and disappears after a while. When the message disappears, operation becomes invalid.

# 2

ON/STANDBY

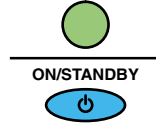

## Press ON/STANDBY again.

Cooling starts. Once cooling is completed, the LAMP and FAN indicators turn off and the standby mode is set. (The ON indicator turns in orange.)

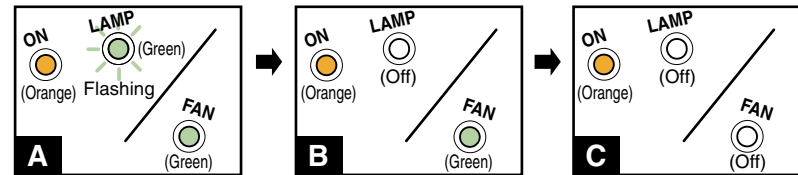

- A** To protect the light source lamp, the LAMP indicator blinks as long as a minimum of cooling is necessary. The power cannot be turned back on during this time. Unplugging the power cord at this time will shorten the lamp's duration life.
- B** The cooling fan continues to run for a while to expel the heat remaining inside. If you are in a hurry, however, you may unplug the power cord at this time.
- C** The standby mode is set.

### Notes

- The projector consumes about 15W of power in the standby mode. We recommend you unplug the power cord when not using the projector for long periods of time.
- Be sure that the LAMP indicator has turned off before unplugging the power cord. Cutting the power by unplugging the power cord while the projector is operating or the light source lamp is being cooled will shorten the lamp's duration life. **Should a fault or some other irregularity arise with this unit, unplug the power cord.**
- When reinserting the power plug before the lamp has cooled, please wait until the lamp has cooled sufficiently before use. When the lamp is at a high temperature, it may not light and its life duration will be shortened.

Remote control

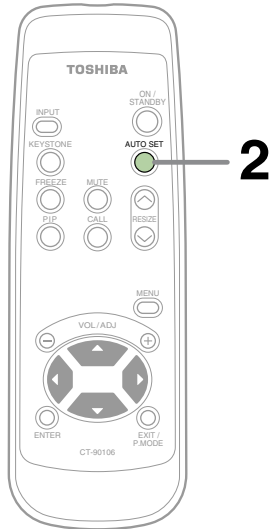

Control panel  
(Main unit side)

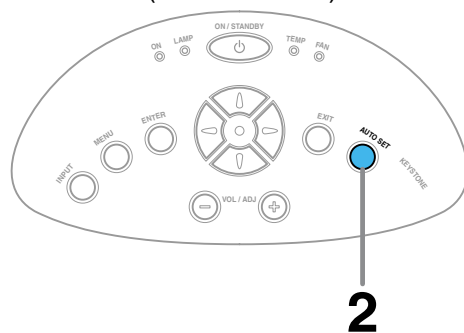

You can adjust the optimum horizontal position, vertical position, sampling phase and sampling frequency for projecting analog RGB signals at the touch of a button.

# 1

**Input full screen video signals from the input source (computer) and project the image.**

Adjustments may not be performed properly for images that are not displayed on the entire screen or for extremely dark images.

# 2

AUTO SET



AUTO SET



**Press AUTO SET.**

The horizontal position, vertical position, sampling phase and sampling frequency are adjusted automatically.

The icon  appears during signal processing.

## Notes

- Automatic adjustment may not be performed properly for signals other than those computers' signals with which the projector is compatible.
- The horizontal position, vertical position, sampling phase and sampling frequency can also be adjusted from the menu screen [47](#).

### \* Sampling frequency

Analog RGB signals input from the computer are converted into digital signals inside the projector. The sampling frequency is the number of times per second the analog signals are converted into digital signals. In order to capture (sample) each individual dot of the computer's signals, the sampling frequency must be adjusted to match the computer's dot clock frequency. If this adjustment is off, details of the image details may be blurred, a striped pattern may appear if images with many vertical lines are displayed, or the image's width may change. For computer signals with which are projector-compatible, the sampling frequency is adjusted automatically even when the **AUTO SET** button is not pressed.

### \* Sampling phase

The sampling phase is the timing at which the computer's analog RGB signals are sampled. If the sampling phase is off, the individual dots cannot be sampled at the proper timing, resulting in blurred or flickering images.

Remote control

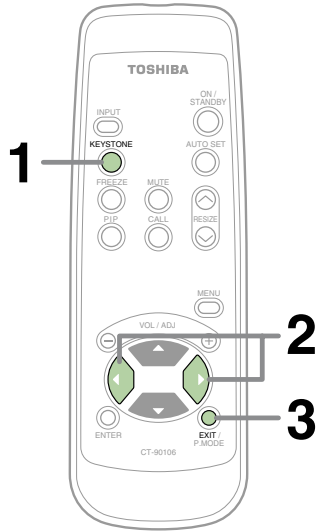

Control panel  
(Main unit side)

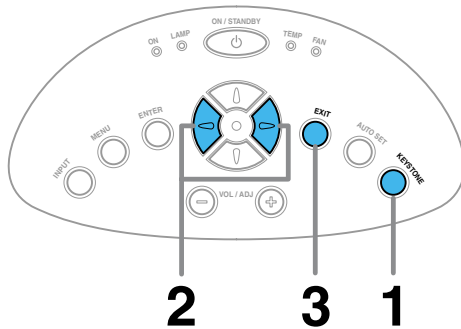

A picture may be expanded on the upper side if projected upward from the projector lifted up by the foot adjuster. The projector can correct this keystone distortion.

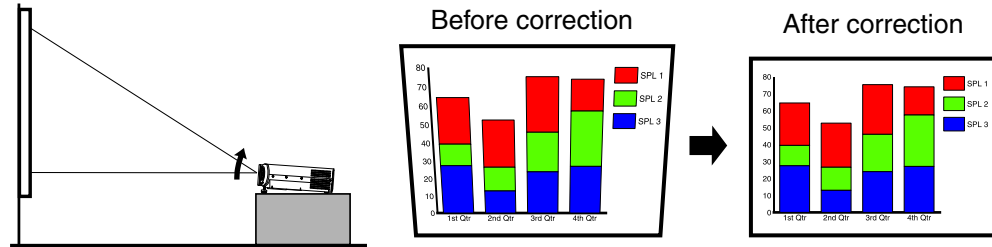

1

KEYSTONE



KEYSTONE



**Press KEYSTONE.**

The keystone adjustment menu appears.

(This menu is the same as the sub-menu which is displayed when “Correct the keystone distortion of the screen” is selected from GUIDE MENU. **45**)

2



**Adjust the distortion with the selection buttons (</>).**

: The upper part of the screen shrinks.

: The upper part of the screen expands.

3



EXIT



**To finish the adjustment, press EXIT repeatedly until the menu disappears.**

**Notes**

- Turn the lens shift dial clockwise fully before using the foot adjuster. **20**
- Due to digital correction processing, some of the information may be dropped or the picture quality may be degraded depending on the keystone correction setting or the contents of the signal source.

Remote control

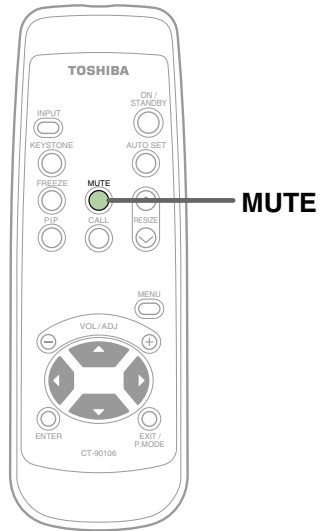

The image and sound of this projector can be turned off if you wish to temporarily project the image from another projector or an OHP, etc., onto the screen.



## Press MUTE.

The sound and picture are cut off temporarily.  
To cancel the mute mode, press **MUTE** again. The image and sound will be output.

The  icon appears in the mute mode.

### Note

The mute mode is cancelled if another operation is performed during the mute mode.

## Remote control

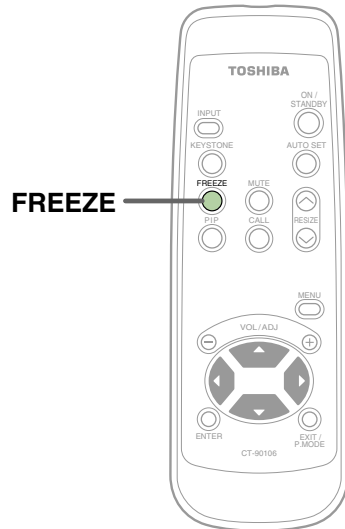

You can freeze the image being projected.

Use this function to stop moving images from a video recorder during presentations.

FREEZE



### Press **FREEZE**.

The picture freezes.

To release the picture, press **FREEZE** again.



The icon appears in the freeze mode.

### Notes

- The frozen image can be enlarged with the **RESIZE** buttons. The freeze mode is cancelled if any operation other than **RESIZE** is performed.
- The freeze mode cannot be set when there is no input (when no signals are being supplied from a signal source).
- The input source's moving image continues to run even when the projector is set in freeze mode.

## Remote control

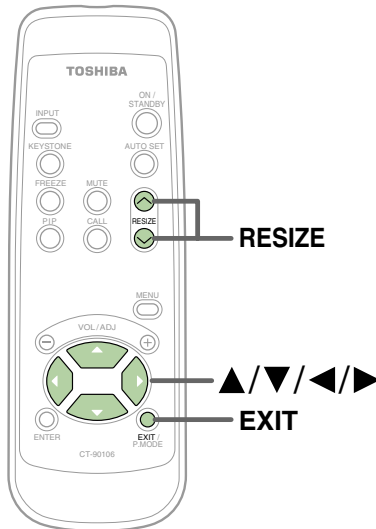

The icon  appears in the resize mode.

You can enlarge (resize) the picture size projected.

  
 RESIZE

### Press RESIZE (^).

The enlargement ratio increases each time the **RESIZE (^)** button is pressed.

The enlargement ratio can be increased continuously by keeping the button pressed in.

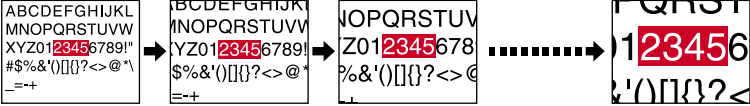

  
 RESIZE

### To reduce the enlargement ratio, press the RESIZE (v) button.

The enlargement ratio can be reduced continuously by keeping the button pressed in.

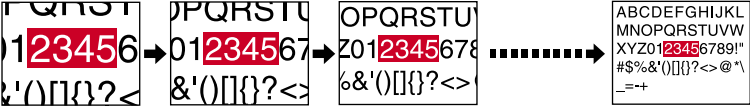



### The enlarged section is moved when the selection buttons (▲/▼/◀/▶) are pressed.

The section can be moved continuously by keeping the button pressed in.

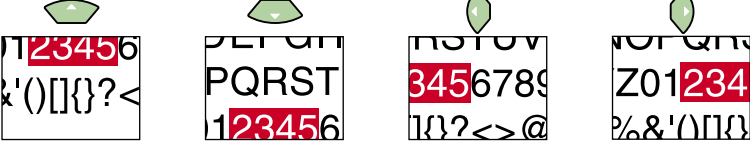

  
 EXIT

### Press the EXIT button to cancel the resize mode and return to the original size.

## Notes

- Enlarged images can be frozen by pressing the **FREEZE** button. The frozen image can also be enlarged or reduced.
- The resize mode is cancelled if any operation other than setting the freeze mode is performed.
- This projector uses electrical digital resizing, so the picture quality degrades when images are enlarged.
- In rare cases, the picture may be disturbed while the magnification section is being moved.
- This function does not work in no input status (no signal is supplied from the signal source).

Remote control

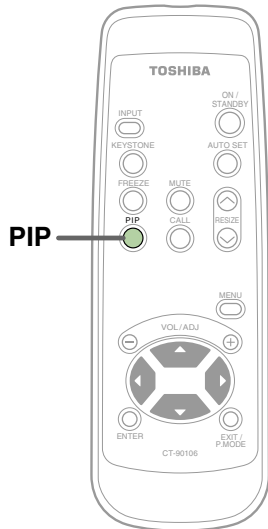

Video or S-video images can be displayed as small images within the computer's image. (Referred to as "sub-pictures" in this manual.)



## Press PIP.

A sub-picture is displayed.

Press the **PIP** button again to turn off the sub-picture.

### Notes

- The PIP function cannot be used when a source other than an RGB input source is selected.
- The PIP function cannot be used without signals supplied from an RGB signal source.
- The sub-picture turns off if any other operation is performed.
- The signal source, size and display position to display sub-pictures can be changed from the menu screen. [53](#)

## Remote control

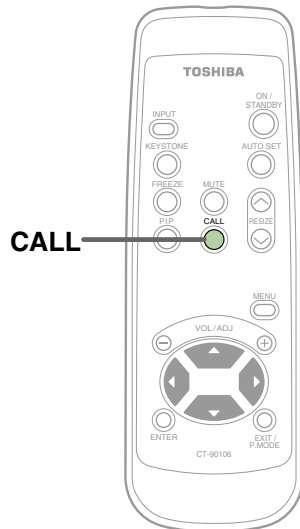

Information on the input signal source, etc., can be displayed.



### Press CALL.

The information described below is displayed.

The information display turns off when the **CALL** button is pressed again.



### Status display

- Input - current input source
- H-resolution - the horizontal resolution of the input signal (at RGB input)
- V-resolution - the vertical resolution of the input signal (at RGB input)
- H-frequency - the horizontal frequency of the input signal (at RGB input)
- V-frequency - the vertical frequency of the input signal (at RGB input)
- Sync - the polarity of the sync signal (at RGB input)
- Video mode - the color mode of the video signal (at Video, S-Video input)
- Signal format - the formatting of the Y/P<sub>B</sub>/P<sub>R</sub> signal (at Y/P<sub>B</sub>/P<sub>R</sub> input)
- Lamp time - the elapsed usage time of the lamp
- Version - the version of the firmware
- Shutter - the shutter speed of the document imaging camera (at document imaging camera input)

### Notes

- The information displayed is not refreshed even if it changes. To refresh the information, turn off the information display, then turn it back on.
- The information display turns off if any other operation is performed.
- The “Lamp time” shows an approximate time for lamp replacement. (It should not be used as a lamp warranty time counter.) If the time indicated here nears 1500H, contact your store of purchase about obtaining a replacement lamp (TLPL55, sold separately).
- The “Lamp time” can be reset when the lamp is replaced.
- The “Version” is the version of the control program used in the projector and is used for servicing, etc.



You can change the slide, for the presentation on the computer, by using the remote control when connecting the projector to the computer with the supplied USB cable.

## 1 Connect a computer to the projector with the supplied USB cable.

Also connect the RGB cable and the audio cable if necessary. [23](#)

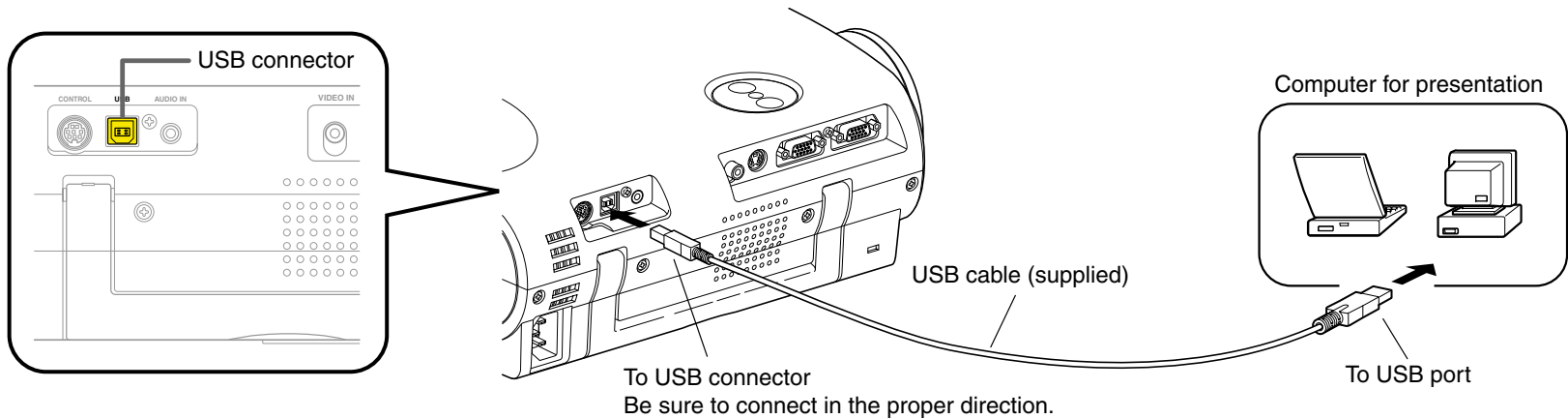

### Notes

- This function is available with O.S (operating system) of Windows 98/98SE, Windows Me, Windows 2000, Windows XP or Mac OS9 with a USB port as standard.
- When connecting to the computer's USB port for the first time, a message asking you to insert the Windows98 or Windows 98SE CD-ROM may appear on the computer's monitor screen, depending on whether or not the device driver is installed. If so, do as the message says.
- When using a USB cable other than the supplied one, be sure to use a shielded type.

## 2



### Start a presentation on the computer.

- In case of Microsoft® PowerPoint®, start the slide show to make a state of displaying the first slide.
- In case of Adobe® Acrobat® or AcrobatReader®, make state that [Full Screen] is selected from [View] menu.
- This function is also available in other application software that can change a slide by pressing , of a computer.

Remote control

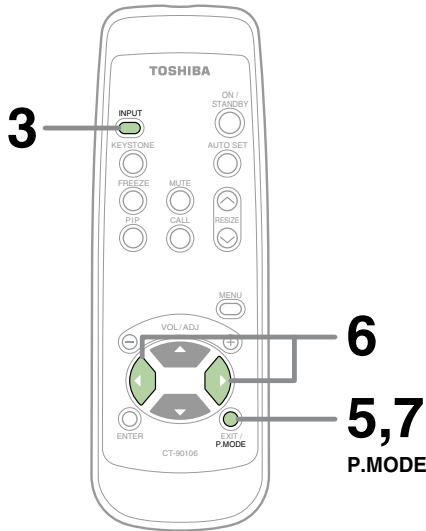

Control panel  
(Main unit side)

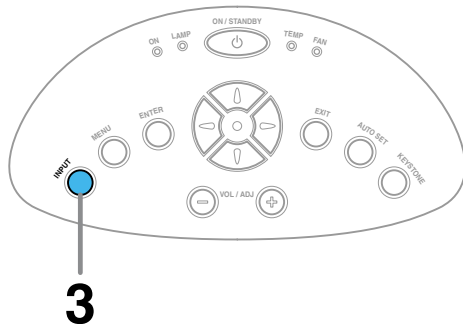

3

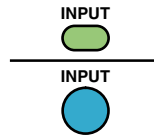

Select the computer input with INPUT.

You can change the order of procedure 1 to 3.

4

Adjust the projector before presentation if necessary.

In the presentation mode after step 5, the projector cannot be adjusted.

5



Press P.MODE and hold for two seconds.

The projector enters into the presentation mode.

The icon  appears in the presentation mode.

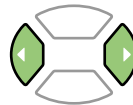

6



Change a slide with the selection buttons (◀/▶).

 : Advancing to the next slide.

 : Returning to the previous slide.

- The selection buttons of the main unit can not be used.
- The slide can not be switched even if you press and hold the selection buttons continuously.  
(The function is different from the ,  keys of the computer.)

7



When the presentation is finished;

To exit the presentation mode, press P.MODE.

The projector returns to the normal mode.

Various adjustments and settings can be made on the menu screen. The basic operations on the menu screen are shown here.

**Start** **GUIDE MENU:** You can adjust or set the functions used frequently.

**Press MENU.**  
Then GUIDE MENU appears. (Then FULL MENU appears if the latest operation had been finished with the FULL MENU and afterwards power is not turned off.)

The current input source → Analog RGB

Items

- Adjust the image brightness.
- Adjust the image flicker.
- Select the image with its brightness priority or quality (color) priority.
- Correct the keystone distortion of the screen.
- Select the input source when changing the input.

Button operation guide

- FULL
- Item
- Next
- Quit

**When you make more detailed adjustments and settings, call the FULL MENU.**

Return to the GUIDE MENU when the MENU button is pressed.

**FULL MENU:** For the operating instruction, refer to the next page. [44](#)

**Press MENU button once again.**  
The FULL MENU of [Picture] appears.  
FULL MENU has seven pages of [Picture], [Position], [Color], [Audio], [Display], [Default setting] and [Reset].  
Use the selection button (◀/▶) to change the page of FULL MENU.

**Select the item with the selection button (▲/▼).**

**Press ENTER to confirm.**  
The item selected can be adjusted or set.

**Adjust and set it with the button indicated on the button operation guide.**  
According to the selected item, the kind ([adjustment],[setting] or [execution]) and the button to be used are indicated on the button operation guide.

**Press EXIT and return.**  
When you select other items, press EXIT repeatedly until GUIDE MENU appears.  
When you want to quit, press EXIT repeatedly until GUIDE MENU disappears.

**End**

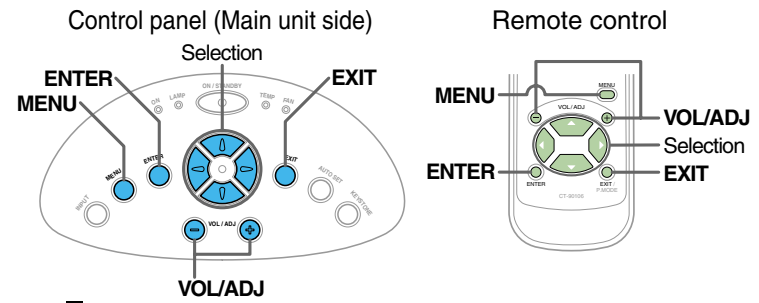

**Note**  
The item displayed on the menu with gray is not available.

**Start** For the selection method of FULL MENU, refer to [43](#) the previous page.

**Select the item with selection buttons (▲/▼).**  
 State of a figure below is a sample for explanation.  
 This state does not in fact.

The current input source: Analog RGB

Kind (page) of FULL MENU: Picture

Items:

- Contrast -12
- Brightness -12
- Picture mode Bright
- Screen size Full
- Reset

Adjustment display bar: [Slider]

Choices: Full Thru

Button operation guide:

- GUIDE
- Page
- Item
- Adjust
- Execute
- Quit

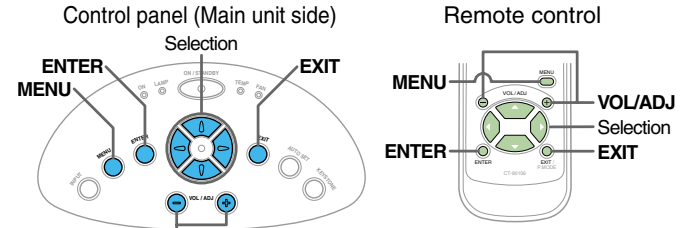

At the items whose the adjustment bar is displayed;

At the items whose the choices are displayed;

**Adjust with VOL/ADJ (+/-)**  
 Press the selection button (▲/▼) when selecting other items continuously.

Method -1

Method -2

At the items whose [Execute] is displayed on the operation guide;

**Press ENTER.**  
 The Item selected is executed. FULL MENU is displayed after execution.

**Press ENTER.**  
 An object can be selected from the sub menu list.

**Press ENTER.**  
 Only the (small list of the) selected adjusting items is displayed. This is useful as you can see a main picture not hidden under FULL MENU.

Select it with the button indicated on the button operation guide.

**Adjust with VOL/ADJ (+/-) or selection buttons (◀/▶).**

**Press EXIT.**  
 FULL MENU is displayed and you can select other items.

**End**

**Press EXIT.**  
 FULL MENU disappears, and adjustment or setting is finished.

**Notes**

- The item displayed on the menu with gray is not available.
- An exclusive menu is displayed when making PIP function sub-picture settings. [53](#)

On GUIDE MENU, you can set or adjust the functions frequently used.

To operate GUIDE MENU, refer to page [43](#).

				The relationship between input source and item				
				Yes: Adjustable - : Not displayed				
				Analog RGB	Y/P <sub>B</sub> /P <sub>R</sub>	Video	S-Video	Camera
Adjust the image brightness.	Contrast	ADJ.	Adjust the contrast of the picture.	Yes	Yes	Yes	Yes	Yes
	Brightness	ADJ.	Adjust the brightness of the picture.					
Adjust the image flicker.	Phase	ADJ.	Adjust the flicker of the picture. (Sampling clock phase adjustment)	Yes	-	-	-	-
Adjust the image color.	Color	ADJ.	Adjust the color depth of the picture.	-	Yes	Yes	Yes	-
Adjust the gain of the document imaging camera.	Camera gain	ADJ.	Adjust the document imaging camera's gain.	-	-	-	-	Yes
Reduce the flicker.	Shutter		Select a shutter speed below to decrease the flickering of the document imaging camera's picture.	-	-	-	-	Yes
	Auto	SET	The shutter speed is set automatically.					
	50Hz	SET	The shutter speed is fixed to 50 Hz.					
	60Hz	SET	The shutter speed is fixed to 60 Hz.					
Select the image with its brightness priority or quality (color) priority.	Bright	SET	The picture is set with its brightness priority.	Yes	-	-	-	-
	True color	SET	The picture is set with its color quality priority.					
Correct the keystone distortion of the screen.	Keystone	ADJ.	Adjust the keystone distortion.	Yes (common for all of the inputs)				
Select the input source when changing the input.	COMPUTER	SET	<input checked="" type="checkbox"/> : COMPUTER IN connector is selectable with the <b>INPUT</b> button.	Yes (common for all of the inputs)				
	Analog RGB	SET	<input checked="" type="checkbox"/> : Use COMPUTER IN connector as Analog RGB input.					
	Y/P <sub>B</sub> /P <sub>R</sub>	SET	<input checked="" type="checkbox"/> : Use COMPUTER IN connector as Y/P <sub>B</sub> /P <sub>R</sub> input.					
	VIDEO	SET	<input checked="" type="checkbox"/> : Video input is selectable with the <b>INPUT</b> button.					
	S-VIDEO	SET	<input checked="" type="checkbox"/> : S-Video input is selectable with the <b>INPUT</b> button.					
	CAMERA	SET	<input checked="" type="checkbox"/> : Camera input is selectable with the <b>INPUT</b> button.					

: On/Off with **ENTER**  
: On/Off with (◀) or (▶)

## Notes

- The items related to the camera (the document imaging camera) are displayed only with models having a camera.
- “Sampling phase” is adjusted and memorized for each RGB signal [70](#).
- “Keystone” and “Input source setting” can be adjusted (set) at all input sources, but the adjustments (settings) made at one input source are applied to all input sources.
- It is impossible to exit from the menu if no input source is selected.
- If the check in the check box for the currently selected source is removed, the setting becomes effective the next time the input is changed.
- The adjustments or settings made are memorized automatically when the power is turned off by pressing the **ON/STANDBY** button. If the power cord is unplugged or if a power failure occurs while the projector is on, the adjustments or settings are not memorized.

# FULL MENU adjustments and settings - Picture

You can make various adjustments or settings of the picture from FULL MENU [Picture].  
To operate FULL MENU, refer to page [44](#).

				The relationship between input source and item				
				Yes: Adjustable	-: Not displayed			
				Analog RGB	Y/P <sub>B</sub> /P <sub>R</sub>	Video	S-Video	Camera
Contrast	ADJ.	Adjust the contrast of the picture.		Yes	Yes	Yes	Yes	Yes
Brightness	ADJ.	Adjust the brightness of the picture.		Yes	Yes	Yes	Yes	Yes
Sharpness	ADJ.	Adjust the sharpness of the picture. (In Y/P <sub>B</sub> /P <sub>R</sub> input mode, sharpness is a setting item.)		-	Yes	Yes	Yes	Yes
Camera gain	ADJ.	Adjust the document imaging camera's gain.		-	-	-	-	Yes
Picture mode	Bright	SET	The picture is set with its brightness priority.	Yes	-	-	-	-
	True color	SET	The picture is set with its color quality priority.					
Video mode	Auto.	SET	The video mode (color system) is set automatically.	-	-	Yes	Yes	-
	NTSC	SET	The video mode is fixed to NTSC system.					
	PAL	SET	The video mode is fixed to PAL system.					
	SECAM	SET	The video mode is fixed to SECAM system.					
	PAL-N	SET	The video mode is fixed to PAL-N system.					
	PAL-M	SET	The video mode is fixed to PAL-M system.					
	PAL60	SET	The video mode is fixed to PAL60 system.					
	NTSC4.43	SET	The video mode is fixed to NTSC4.43 system.					
Signal format	Auto.	SET	The Y/P <sub>B</sub> /P <sub>R</sub> signal format is set automatically.	-	Yes	-	-	-
	480i (525i)	SET	The Y/P <sub>B</sub> /P <sub>R</sub> signal format is fixed to 480i (525i) mode.					
	480p (525p)	SET	The Y/P <sub>B</sub> /P <sub>R</sub> signal format is fixed to 480p (525p) mode.					
	575i (625i)	SET	The Y/P <sub>B</sub> /P <sub>R</sub> signal format is fixed to 575i (625i) mode.					
	720p (750p)	SET	The Y/P <sub>B</sub> /P <sub>R</sub> signal format is fixed to 720p (750p) mode.					
	1080i (1125i)	SET	The Y/P <sub>B</sub> /P <sub>R</sub> signal format is fixed to 1080i (1125i) mode.					
Shutter	Auto.	SET	The shutter speed is set automatically.	-	-	-	-	Yes
	50Hz	SET	The shutter speed is fixed at 50 Hz.					
	60Hz	SET	The shutter speed is fixed at 60 Hz.					
Screen size	Full	SET	TLP560/561: The picture is converted to XGA (1024 x 768 dot) resolution. TLP260/261: The picture is converted to SVGA (800 x 600 dot) resolution.	Yes	Yes	Yes	Yes	TLP261: Yes TLP561: -
	Thru	SET	The picture is displayed with the input source resolution.					
	Wide	SET	The picture is converted to wide screen format.					
Reset	EXEC.	Return the adjustments and settings of FULL MENU [Picture] to the factory default values.		Yes	Yes	Yes	Yes	Yes

## Notes

- The items related to the camera (the document imaging camera) are displayed only with models having a camera.
- A part of function is restricted if you set the "Video mode" or "Signal format" to the modes other than [Auto.] . [51](#)
- The adjustments or settings made are memorized automatically when the power is turned off by pressing the **ON/STANDBY** button. If the power cord is unplugged or if a power failure occurs while the projector is on, the adjustments or settings are not memorized.

# FULL MENU adjustments - Position

You can adjust the picture position etc. of the analog RGB input from FULL MENU [Position].  
To operate FULL MENU, refer to page [44](#).

			The relationship between input source and item					Yes: Adjustable - : Not displayed	
			Analog RGB	Y/Pb/Pr	Video	S-Video	Camera		
H-position	ADJ.	Adjust the horizontal display position of the picture.	Yes	-	-	-	-	-	
V-position	ADJ.	Adjust the vertical display position of the picture.	Yes	-	-	-	-	-	
Phase	ADJ.	Adjust the flicker of the picture. (Sampling clock phase adjustment)	Yes	-	-	-	-	-	
Frequency	ADJ.	Adjust the sampling frequency of the input signal if vertical stripes appear in the detailed image.	Yes	-	-	-	-	-	
Reset	EXEC.	Return the adjustments of FULL MENU [Position] to the factory default values.	Yes	-	-	-	-	-	

## Notes

- This menu is not displayed except with analog RGB input.
- The adjustment of each item in this menu is memorized for each RGB signal input [70](#).
- The adjustments made are memorized automatically when the power is turned off by pressing the **ON/STANDBY** button. If the power cord is unplugged or if a power failure occurs while the projector is on, the adjustments are not memorized.

# FULL MENU adjustments - Color

You can adjust the color condition of the picture from FULL MENU [Color].  
To operate FULL MENU, refer to page [44](#).

			The relationship between input source and item				
			Yes: Adjustable - : Not displayed				
			Analog RGB	Y/P <sub>B</sub> /P <sub>R</sub>	Video	S-Video	Camera
Color	ADJ.	Adjust the color depth of the picture.	-	Yes	Yes	Yes	-
Tint	ADJ.	Adjust the tint of the picture. (Not adjustable at PAL, SECAM, PAL-N, PAL-M and PAL60)	-	-	Yes	Yes	-
R-level	ADJ.	Adjust the red level of the picture.	Yes	Yes	Yes	Yes	Yes
G-level	ADJ.	Adjust the green level of the picture.	Yes	Yes	Yes	Yes	Yes
B-level	ADJ.	Adjust the blue level of the picture.	Yes	Yes	Yes	Yes	Yes
Reset	EXEC.	Return the adjustments of FULL MENU [Color] to the factory default value.	Yes	Yes	Yes	Yes	Yes

## Note

The adjustments made are memorized automatically when the power is turned off by pressing the **ON/STANDBY** button. If the power cord is unplugged or if a power failure occurs while the projector is on, the adjustments are not memorized.



# FULL MENU adjustments and settings - Audio

You can set the sound emitted from the speaker from FULL MENU [Audio].  
To operate FULL MENU, refer to page [44](#).

				The relationship between input source and item					Yes: Adjustable	-: Not displayed
				Analog RGB	Y/P <sub>B</sub> /P <sub>R</sub>	Video	S-Video	Camera		
Volume	ADJ.	Adjust the sound volume emitted from the speaker.		Yes	Yes	Yes	Yes	-		
Speaker output	On	SET	The sound is emitted from the speaker.	Yes (common)					-	
	Off	SET	No sound is emitted from the speaker.							
Channel select	L+R	SET	The sound of the left and right channels is mixed and emitted from the speaker.	Yes (common)					-	
	L	SET	Only the sound of the left input channel is emitted from the speaker.							
	R	SET	Only the sound of the right channel is emitted from the speaker.							
Loudness	On	SET	The loudness effect is added to the speaker sound.	Yes (common)					-	
	Off	SET	The loudness effect is not added to the speaker sound.							
Reset	EXEC.	Return the adjustments and settings of FULL MENU [Audio] to the factory default values.		Yes (common)					-	

## Notes

- When the camera input is selected, sound is not emitted.
- Each item can be set at every input source except the camera input, but the settings made at one input source are applied to all input sources as shown in the table. The sound volume can be adjusted for each input source except the camera input.
- The adjustments or settings made are memorized automatically when the power is turned off by pressing the **ON/STANDBY** button. If the power cord is unplugged or if a power failure occurs while the projector is on, the adjustments or settings are not memorized.

# FULL MENU adjustments and settings - Display

You can set the language, menu display, etc. from FULL MENU [Display].  
 To operate FULL MENU, refer to page [44](#).

				The relationship between input source and item				
				Yes: Adjustable	-: Not displayed			
				Analog RGB	Y/Pb/Pr	Video	S-Video	Camera
Keystone	ADJ.	Adjust the keystone distortion caused by changing the installation angle.		Yes (common for all of the inputs)				
Language	English	SET	Menus and messages are displayed in English.	Yes (common for all of the inputs)				
	Français	SET	Menus and messages are displayed in French.					
	Deutsch	SET	Menus and messages are displayed in German.					
	Italiano	SET	Menus and messages are displayed in Italian.					
	Español	SET	Menus and messages are displayed in Spanish.					
	Português	SET	Menus and messages are displayed in Portuguese.					
	日本語	SET	Menus and messages are displayed in Japanese.					
	中文(简体字)	SET	Menus and messages are displayed in Chinese (Simplified).					
	中文(繁體字)	SET	Menus and messages are displayed in Chinese (Traditional).					
	한국어	SET	Menus and messages are displayed in Korean.					
Icon	On	SET	The icon is displayed.	Yes (common for all of the inputs)				
	Off	SET	The icon is not displayed.					
Menu position	Upper left	SET	The menu is displayed at the upper left of the screen.	Yes (common for all of the inputs)				
	Upper right	SET	The menu is displayed at the upper right of the screen.					
	Lower left	SET	The menu is displayed at the lower left of the screen.					
	Lower right	SET	The menu is displayed at the lower right of the screen.					
Menu translucent	On	SET	The menu background becomes translucent.	Yes (common for all of the inputs)				
	Off	SET	The menu background is normal.					
Reset	EXEC.	Return the adjustments and settings of FULL MENU [Display] to the factory default values.		Yes (common for all of the inputs)				

## Notes

- Each item can be set at all input sources, but the settings made at one input source are applied to all input sources.
- The adjustments or settings made are memorized automatically when the power is turned off by pressing the **ON/STANDBY** button. If the power cord is unplugged or if a power failure occurs while the projector is on, the adjustments or settings are not memorized.
- The setting of “Menu translucent” is not available if no signal is input. Also, the background of the menu will not be translucent, regardless of the settings.

# FULL MENU settings - Default setting

You can set the Input source, projection mode, etc. from FULL MENU [Default setting].

To operate FULL MENU, refer to page 44.

			The relationship between input source and item				
			Yes: Adjustable	-: Not displayed			
			Analog RGB	Y/Pb/Pr	Video	S-Video	Camera
Input source setting ☑ : On/Off with <b>ENTER</b> ⊙ : On/Off with (◀) or (▶)	COMPUTER	SET	☑ : COMPUTER IN connector is selectable with the <b>INPUT</b> button.				
	Analog RGB	SET	⊙ : Use COMPUTER IN connector as Analog RGB input.				
	Y/Pb/Pr	SET	⊙ : Use COMPUTER IN connector as Y/Pb/Pr input.				
	VIDEO	SET	☑ : Video input is selectable with the <b>INPUT</b> button.				
	S-VIDEO	SET	☑ : S-Video input is selectable with the <b>INPUT</b> button.				
	CAMERA	SET	☑ : Camera input is selectable with the <b>INPUT</b> button.				
			Yes (common for all of the inputs)				
Projection mode	Standard	SET	The projector is set to the floor-mounted front projection mode.				
	Rear	SET	The projector is set to the floor-mounted rear projection mode.				
	Ceiling	SET	The projector is set to the ceiling-mounted front projection mode.				
	Rear ceiling	SET	The projector is set to the ceiling-mounted rear projection mode.				
			Yes (common for all of the inputs)				
Background	Logo	SET	The TOSHIBA logo is displayed when no signal is input.				
	Blue	SET	The entire screen is set to blue when no signal is input.				
	None	SET	Nothing is displayed when no signal is input.				
			Yes (common for all of the inputs)				
No signal power off	Off	SET	The power does not turn off automatically even if no signal status continues.				
	5 min.	SET	The power turns off automatically when no signal status continues for approx. 5 min.				
			Yes (common for all of the inputs)				
Power on	Manual	SET	The power turns on by pressing the <b>ON/STANDBY</b> button.				
	Auto.	SET	When the power plug is inserted, the power is on.				
			Yes (common for all of the inputs)				
Start-up screen	On	SET	The start-up display appears when the power is turned on.				
	Off	SET	The start-up display does not appear when the power is turned on.				
			Yes (common for all of the inputs)				
Reset	EXEC.	Return the settings of FULL MENU [Default setting] to the factory default values.					
			Yes (common for all of the inputs)				

## Notes

- It is impossible to exit from the menu if no input source is selected.
- If the check in the check box for the currently selected source is removed, the setting becomes effective the next time the input is changed.
- In the following conditions, the function to detect no signal (“No signal background”, “No signal power off”) does not activate:
  - 1) When “Video mode” 46 is set to the modes other than [Auto] and Video input or S-Video input is selected.
  - 2) When “Signal format” 46 is set to the modes other than [Auto] and Y/Pb/Pr input is selected.
- Note that the projector automatically powers up at the restoration of power after a failure, if “Power on” is set to [Auto] with the power plug inserted.
- Even if “Power on” is set to [Auto], the setting of [5 min.] of “No signal power off” is effective.
- Each item can be set at all input sources, but the settings made at one input source are applied in common to all input sources.
- The settings made are memorized automatically when the power is turned off by pressing the **ON/STANDBY** button. If the power cord is un-plugged or if a power failure occurs while the projector is on, the settings are not memorized.

# FULL MENU settings - Reset

You can return the adjusting and setting values of all menus to the factory default setting.













Reset all	EXEC.	Return the adjustments and settings of all menus to the factory default setting.
-----------	-------	--

## Note

The resettings made are memorized automatically when the power is turned off by pressing the **ON/STANDBY** button. If the power cord is unplugged or if a power failure occurs while the projector is on, the resettings are not memorized.

# PIP menu setting

When a PIP sub-picture is displayed, the PIP menu screen will appear if you press the **MENU** button. You can make the PIP sub-picture settings when a PIP subpicture is displayed. To cancel the menu, press the **EXIT** button.

Source	Select the signal source for PIP sub-picture.	
Video	SET	 : Video input is selected as signal source.
S-Video	SET	 : S-Video input is selected as signal source.
Size	Set the PIP sub-picture size.	
Small	SET	 : The PIP sub-picture size is set to small.
Medium	SET	 : The PIP sub-picture size is set to medium.
Large	SET	 : The PIP sub-picture size is set to large.
Position	Set the PIP sub-picture display position.	
	SET	 : The sub-picture is displayed at the upper left of the screen.
	SET	 : The sub-picture is displayed at the upper right of the screen.
	SET	 : The sub-picture is displayed at the lower left of the screen.
	SET	 : The sub-picture is displayed at the lower right of the screen.
Reset	EXEC	Return the settings of PIP MENU to the factory default setting.

## Notes

- The size of the PIP sub-picture differs according to the signal type (resolution) of the main picture.
- The settings made are memorized automatically when the power is turned off by pressing the **ON/STANDBY** button. If the power cord is unplugged or if a power failure occurs while the projector is on, the settings are not memorized.

**CAUTION**

When using the camera, be careful not to pinch your hand or fingers into the arm.

On the document imaging camera model, you can project pictures using the document imaging camera. The document imaging camera can directly project any materials (documents, illustrations, etc.) without using an OHP film.

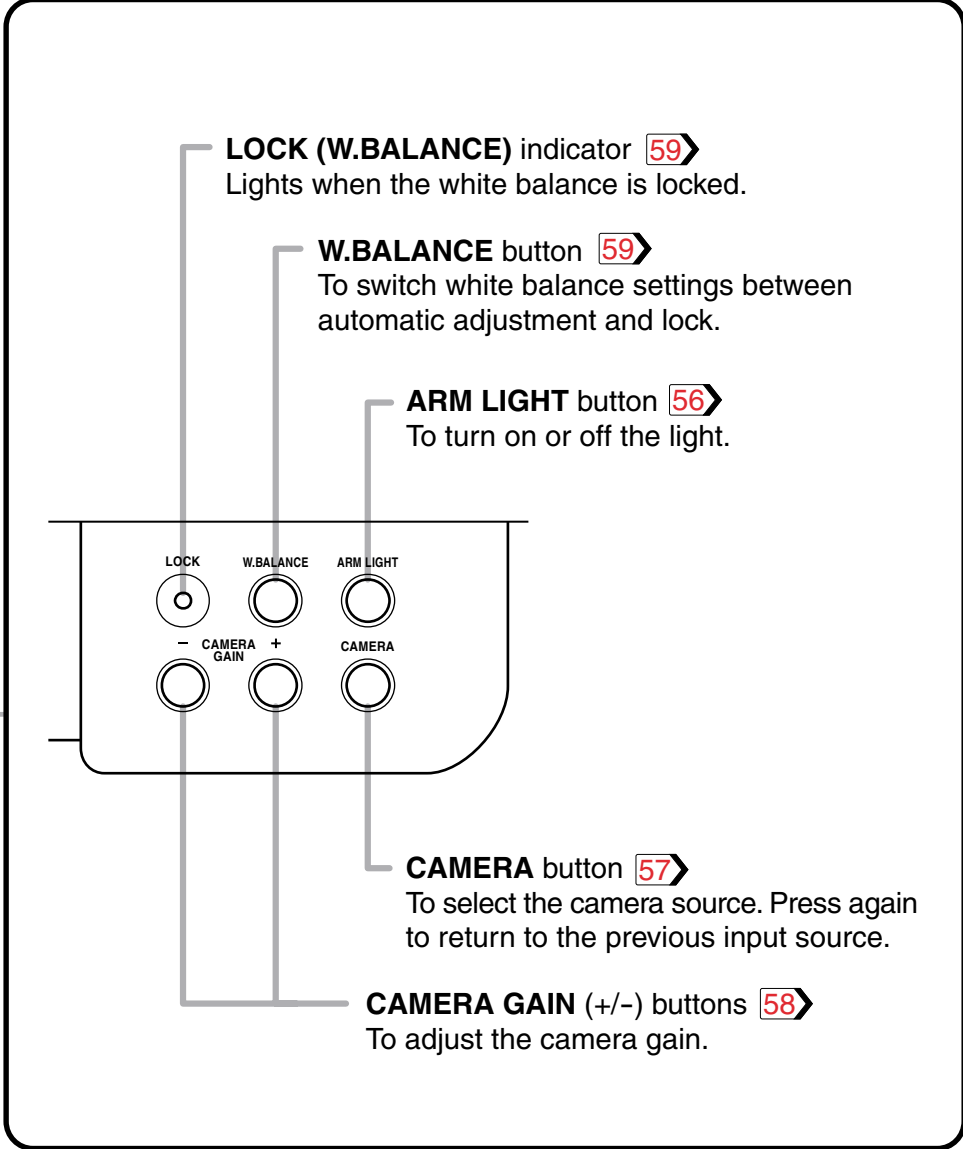
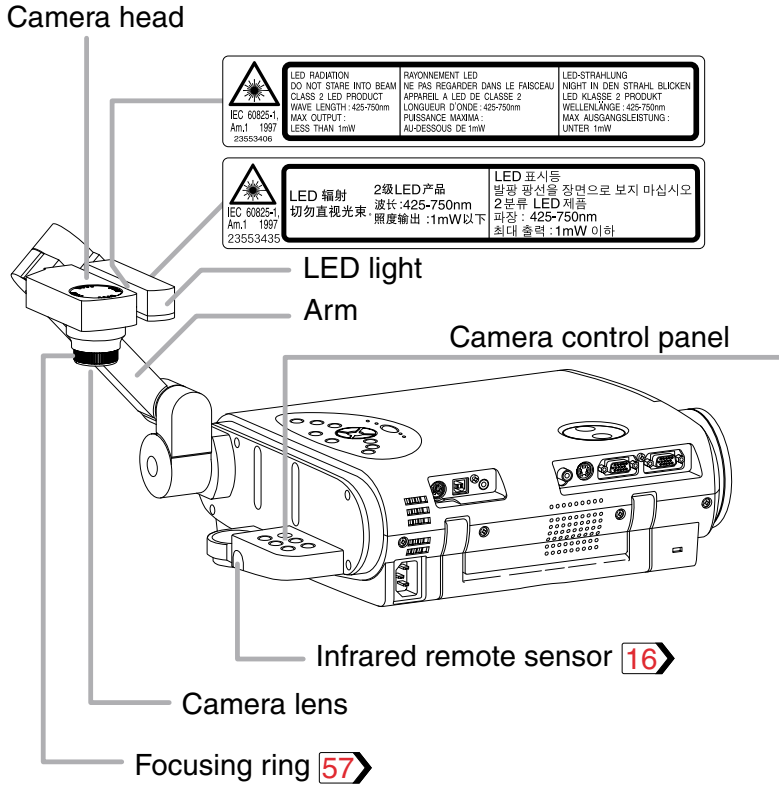

# Preparation of the document imaging camera

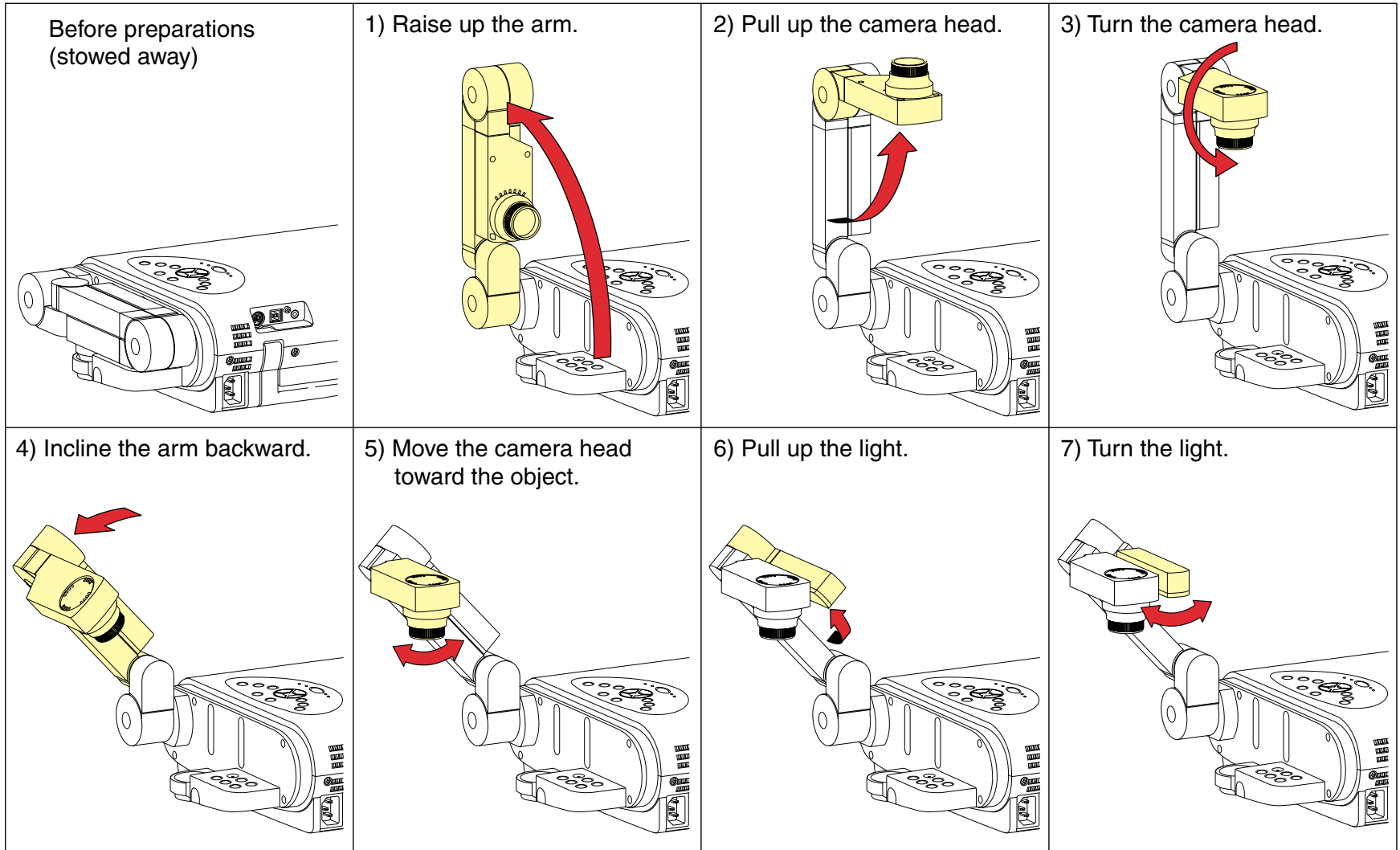

**Note**  
Never give shocks or impacts to the camera or arm as this may cause malfunction.

## CAUTION

Do not look into the arm light while it is lit.

Camera control panel

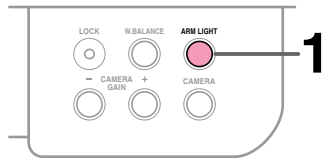

## Preparation

1 Project a picture on the screen as explained in the step “Projection on the screen”. [28](#)

1

ARM LIGHT



### Press ARM LIGHT.

The light turns on.

2

### Set a document to be projected.

Place the document (illustrations, etc.) onto or around the projector, and turn the camera head to the direction of the document.

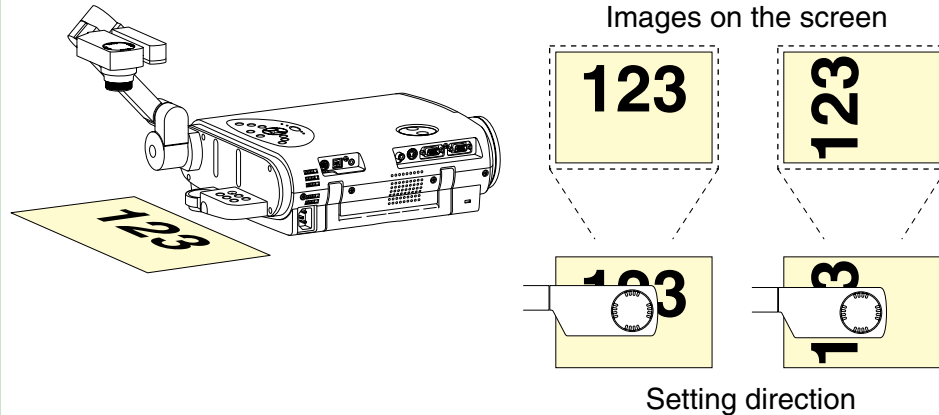

## Notes

- Do not leave documents on the unit or near of the air exhaust for long periods of time. The heat could erase or discolor the letters on a thermal paper.
- Use the arm light when necessary according to the brightness of the room.



Remote control

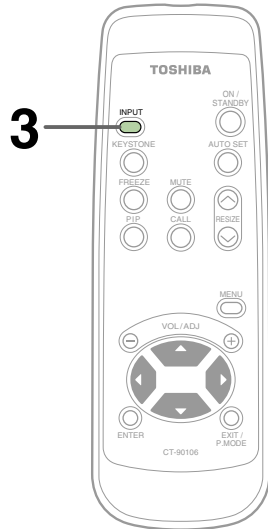

Control panel  
(Main unit side)

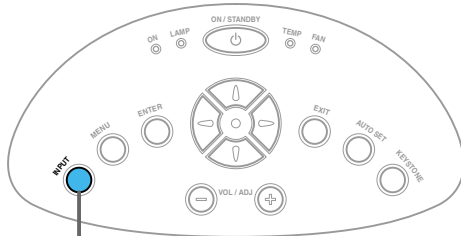

Camera control panel

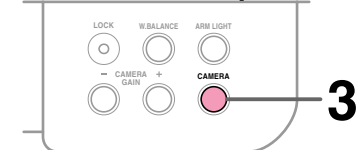

3

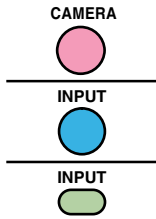

Press **CAMERA** to select the camera input mode.

- Pressing **CAMERA** again will return the input selection to the previous mode.
- You can also select it by pressing **INPUT** on the remote control or on the main unit. Set the input source on the menu screen when selecting by the **INPUT** button. **30**
- The **CAMERA** button can be used regardless of the input setting.
- “Camera” is displayed when the picture switches to the document imaging camera’s picture.

4

Move the camera head to adjust the size of the picture.

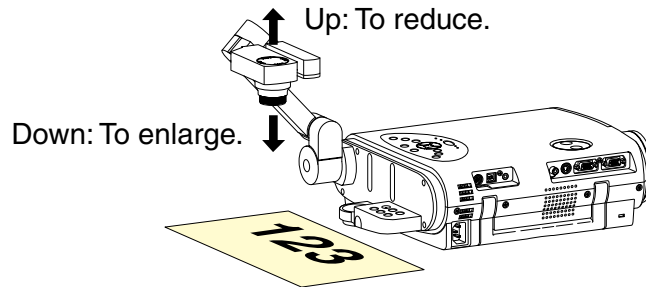

5

Focus on the picture by turning the focusing ring on the camera head.

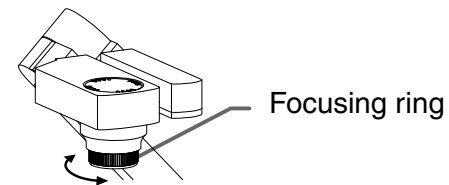

Focusing ring

Camera control panel

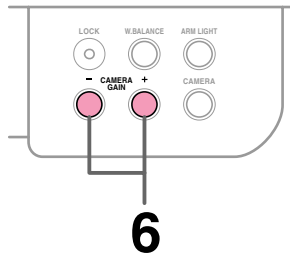

## 6

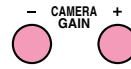

Press **CAMERA GAIN (+/-)** to improve view of a camera subject which is too dark or vivid.

### Notes

- You can adjust the “Sharpness” of the camera image on the menu screen. [46](#)
- If the image flickers due to a fluorescent light in the room, either turn off the fluorescent light or set the “Shutter” on the menu screen. [46](#)

Note that the image may still flicker due to the lighting, the document status, the image adjustment, etc., even if the “Shutter” setting is changed.

## 7

**When finished, turn off the light and close it, and put back the arm.**

Follow the steps of “Preparation of the document imaging camera” in reverse.

### Notes

- The light turns off automatically when the arm is inclined.
- When the arm is not raised up, the camera source cannot be projected.
- In the camera input selected, the sound is not emitted.

Camera control panel

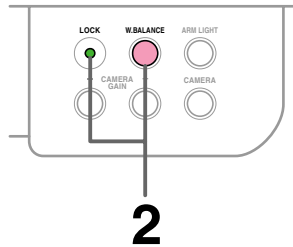

This projector's camera is always being adjusted automatically for projected color balance; however, the balance can shift away from optimum due to the color scheme of the document. Should this occur, the white balance can be set to a fixed condition by using the following procedure.

1

**Project a white paper and enlarge it to fill the screen.**

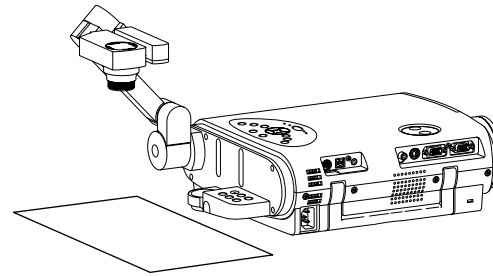

2



**Press W.BALANCE to turn the LOCK indicator on.**

The white balance is locked.  
To release the white balance, press **W.BALANCE** again to turn the LOCK indicator off.

## Notes

- If you raise up the arm while the camera input is being selected, the color of the picture may vary for an instant due to the automatic white balance adjustment. This is not a malfunction.
- If you put the arm back and raise it again while the white balance is locked (the LOCK indicator is lit), the projector will release the white balance.
- Should this be the case, or if you would like to adjust it to a desired tint, adjust "R-level", "G-level" or "B-level" on the FULL MENU [Color] screen.

For the CCD image sensor used in the camera unit, in rare cases some of the pixels may be disturbed due to the influence of cosmic rays, etc. This disturbance may cause white spots to appear on the picture.

If white spots appear on the document camera image, use the procedure described below to correct the problem.

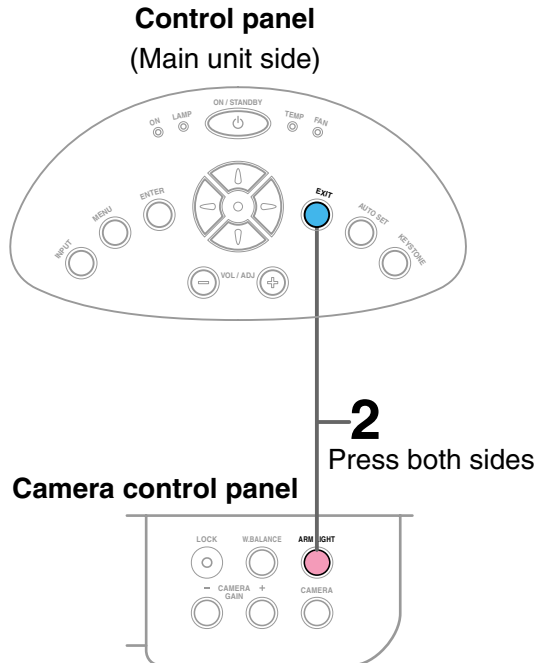
**1**

With the document camera operating, fully cover the camera lens with a piece of black paper or cloth.

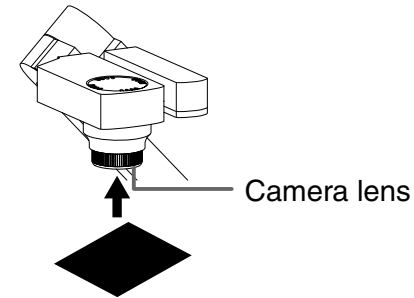
**2**

ARM LIGHT



+

EXIT



Press **ARM LIGHT** on the camera control panel and **EXIT** on the projector's control panel simultaneously.

You can not use the remote control buttons.

## Note

Do not press **ARM LIGHT** and **EXIT** buttons simultaneously if the camera lens is not covered. Doing so will not only erase the white spot correction data already set but also result in parts of the image that are properly displayed being corrected. Also be careful if the camera input mode is not selected.

If there is some problem inside the projector, the indicators light up or blink.

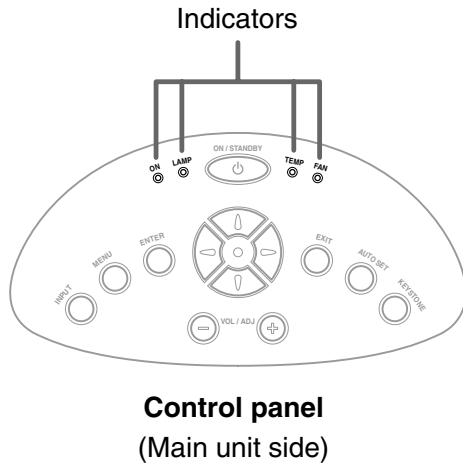

	<p>The power does not come on. → Malfunction of the unit.</p> <ul style="list-style-type: none"> <li>• Unplug the power cord and call the dealer.</li> </ul>
	<p>The lamp turns off or does not light up. → The projector will return to the standby mode in about 2 minutes. If the projector does not operate normally when the power is switched on again, the lamp is at the end of its life duration or the unit has a fault.</p> <ul style="list-style-type: none"> <li>• Lamp's life duration is over, replace the lamp with a new one. <b>65</b></li> <li>• Unplug the power cord and call the dealer.</li> </ul>
	<p>The power turns off or does not come on. → The inside is too hot, or the projector has been working in an area of high temperature.</p> <ul style="list-style-type: none"> <li>• Place the projector correctly so the intake and exhaust fan's holes are not covered.</li> <li>• Turn the projector off, and leave it for a while, and turn it on again.</li> <li>• Clean the air filter. <b>62</b></li> </ul> <p>* The  icon appears before the power turned off. * The projector returns to the standby mode after the fault display has been shown for about 2 minutes.</p>
	<p>The power turns off or does not come on. → Trouble with the cooling fan.</p> <ul style="list-style-type: none"> <li>• Unplug the power cord and call the dealer.</li> </ul> <p>* The  icon appears before the power turned off. * The projector returns to the standby mode after the fault display has been shown for about 2 minutes.</p>
	<p>The power turns off or does not come on. → The lamp cover is not properly attached.</p> <ul style="list-style-type: none"> <li>• Unplug the power cord and reattach the lamp cover. <b>66</b></li> </ul> <p>* The  icon appears before the power turned off. * The projector returns to the standby mode after the fault display has been shown for about 2 minutes.</p>

### Notes

- If abnormality occurs while operating, unplug the power cord.
- When reinserting the power cord before the lamp has cooled, please wait until the lamp has cooled sufficiently before use. When the lamp is at a high temperature, it may not light and the life duration will be shortened.

## CAUTION

If you use the projector mounted on the ceiling, ask the dealer to carry out the maintenance such as cleaning.

The filter inside the air filter cover is the part to shut out dusts or dregs.

Do not use the projector with the filter taken off.

We recommend you clean the air filter frequently. (The cleaning period is once per 50 hours approximately).

**1** Unplug the power cord.

**2**

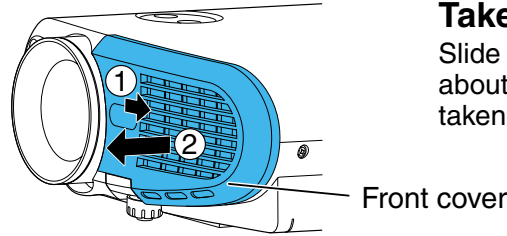

**Take off the front cover.**

Slide the front cover rightward side for about 3 mm, then the front cover can be taken off toward you.

**3**

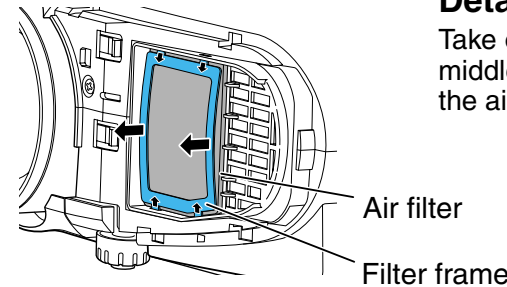

**Detach the air filter.**

Take off the filter frame by pulling the middle part of it toward you, then detach the air filter.

**4**

**Clean the air filter.**

Use a vacuum cleaner to carefully remove any dust and dirt from the front cover, air filter and filter frame.

Be careful that the air filter is not sucked into the vacuum cleaner.

## Notes

- When the air filter is dusty, the ventilation is impaired. This causes the temperature inside the projector to rise, and may damage the unit.
- Attach the air filter and the filter frame firmly after the cleaning. If it is not set correctly, the dusts will enter and they will be projected and overlapped on the picture.
- If you wash the air filter with water, be sure to let it dry fully before reinstalling it. Using it damp will result in malfunction.
- If the air filter is damaged, contact your store of purchase and replace it with a new one. Using a damaged air filter will cause dust or dirt to get inside the projector and onto the images.

## 5 Mount the air filter and the filter frame.

Place the air filter in the projector, then insert the four tabs on the filter frame into the holes in the projector.

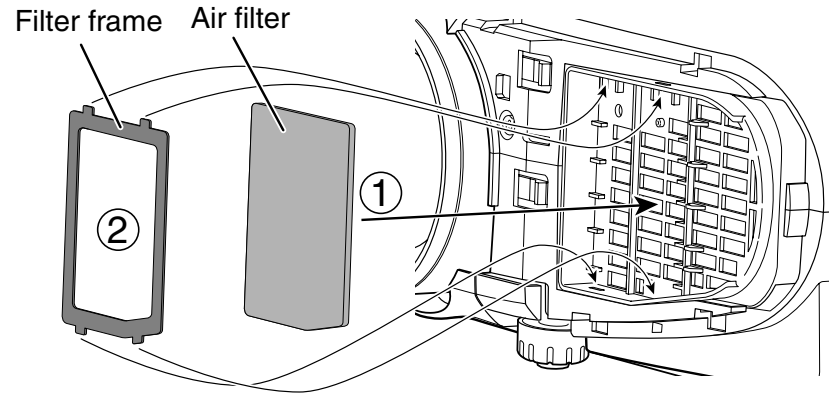

## 6 Mount the front cover.

Insert the hooks of the front cover into the projector first, then slide it to the lens side to fix it.

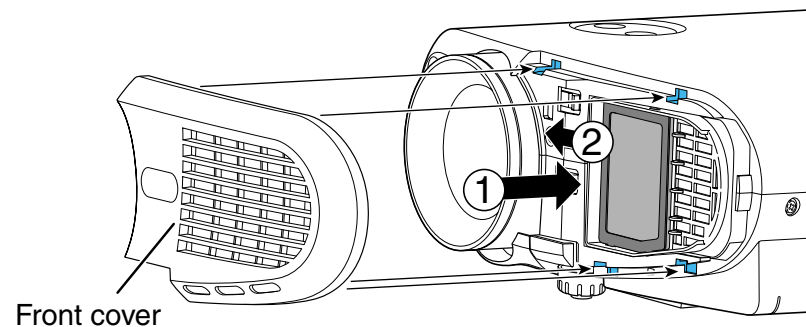

## CAUTION

If you use the projector mounted on the ceiling, ask the dealer to carry out the maintenance such as cleaning.

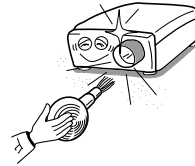

## Cleaning the lens

Use a blower or a lens cleaner to clean the lens. Never rub or tap the lens with a hard object as the lens surface is fragile.

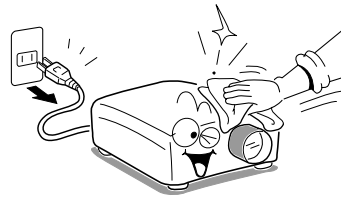

## Cleaning the main unit

- Pull out the power cord before cleaning.
- Use a soft cloth to wipe off stains from the surface.
- To remove difficult stains, use a soft cloth slightly moistened with a weak solution of synthetic detergent and water, and finish with a soft, dry cloth.

## Replacing the intake, exhaust fans and air filter

To maintain the efficiency of the projector, replace the intake and exhaust fans about every two to three years. Ask the dealer for the replacement.



The lamp will eventually begin to project dark or dull pictures and finally will not light up. (Lamp's life depends on operating conditions.) In such a case, replace the lamp with new one.

### CAUTION

- If you use the projector mounted on the ceiling, ask the dealer to carry out the maintenance such as cleaning or replacement of the lamp.
- When replacing, always use lamp "TLPL55" (sold separately). For details, refer to the lamp instruction.
- If you have been using the projector, the lamp will be very hot, and may cause burn injuries. Wait for the lamp to cool (for longer than 1 hour) before replacing it.
- If the lamp should break, please handle with care to avoid injury due to broken pieces and contact your dealer for repair service.

**1** Unplug the power cord.

**2** Wait until the lamp gets cool enough.

**3** **Take off the lamp cover on the bottom panel.**  
Loosen the two screws, and pull off the lamp cover.

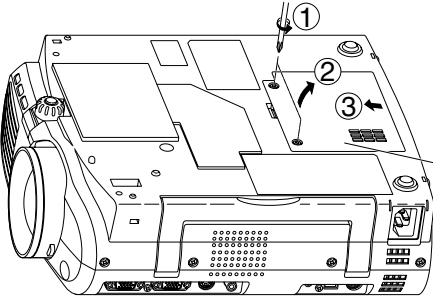

Lamp cover

**4** **Pull out the lamp.**  
Loosen the two fixing screws, and lift up the handle to pull out the lamp.

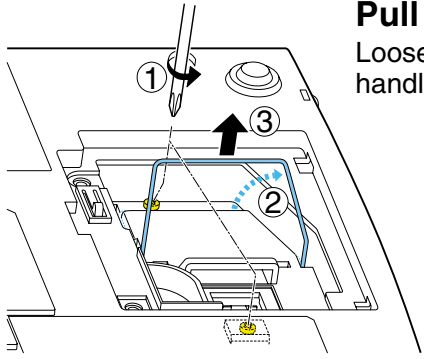

## Notes

- When the **CALL** button is pressed, the “Lamp time” (the approximate amount of time the lamp has been used) will be displayed. **40**
- The lamp should be replaced if the total working time exceeds about 1,500 hours.

When the “Lamp time” is displayed as 1500 hours, the icon  appear. It will disappear when you do some operation.

- Attach the lamp cover firmly after replacing the lamp. If it is not set correctly, the power will not turn on.
- Use a new lamp when replacing it.
- The lamp is made of glass and is very fragile. Do not touch the lamp with your bare hands and do not jolt or damage it. Do not try to use an exhausted lamp.

A small amount of inorganic mercury harmful to environment is used for the lamp. Dispose of the exhausted lamp according to the rules of your area.

## 5 Load a new lamp.

Slide until it hits the bottom and tighten the two fixing screws.

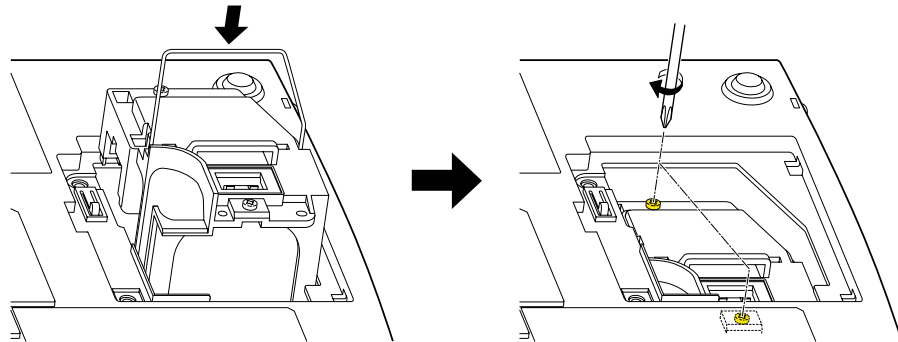

## 6

### Attach the lamp cover.

Slide the cover into place and tighten the two screws.

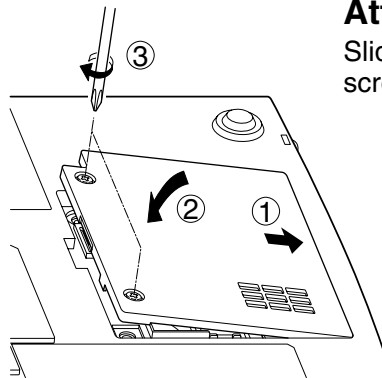

## 7 Reset the lamp timer.

Refer to the lamp instructions for resetting.

# Before calling service personal

Check the following points before asking for support service. Refer also to “Trouble indications”. [61](#)

Symptom	Cause	Correction	Page
The power does not come on.	• The power cord is disconnected.	Firmly plug in the power cord.	<a href="#">19</a>
	• The lamp cover is not attached correctly.	Attach the cover correctly.	<a href="#">66</a>
The power turns off while using the projector.	• The ambient temperature of the projection room is too high.	Lower the ambient temperature of the projection room, and turn the power on.	<a href="#">61</a>
No image appears.	• The lens cover is on.	Take off the lens cover.	<a href="#">19</a>
	• The wrong input is selected.	Select the input source correctly.	<a href="#">30</a>
	• The muting mode is on.	Press <b>MUTE</b> to restore the picture.	<a href="#">36</a>
	• The “Brightness” adjustment is at its darkest.	Make the “Brightness” adjustment.	<a href="#">45</a>
	• The source is not correctly connected to the projector.	Connect the source correctly to the projector.	<a href="#">23</a> - <a href="#">25</a>
No sound is heard.	• The wrong input is selected.	Select the input source correctly.	<a href="#">30</a>
	• The muting mode is on.	Press <b>MUTE</b> to restore the sound.	<a href="#">36</a>
	• The sound volume is at it’s minimum.	Adjust the sound volume.	<a href="#">32</a>
	• The source is not correctly connected to the projector.	Connect the source correctly to the projector.	<a href="#">23</a> - <a href="#">25</a>
Desired input source cannot be selected by the <b>INPUT</b> button.	• Input is not set so that it can be selected with the <b>INPUT</b> button. By default, only the Analog RGB and Video input modes can be selected.	Set from the menu screen so that the source can be selected with the <b>INPUT</b> button.	<a href="#">45</a>
			<a href="#">30</a>
Analog RGB input or Y/Pb/Pr input colors are not right.	• The COMPUTER connector’s input setting is wrong.	On the menu screen, set for the proper input signal type.	<a href="#">45</a>
The image is blurred. Focusing is uneven.	• The lens is dirty.	Clean the lens with a blower or lens cleaner, etc.	<a href="#">64</a>
	• The picture is out of focus.	Focus the picture.	<a href="#">31</a>
	• The projection distance is not appropriate.	Adjust the distance properly.	<a href="#">18</a>
	• The projecting light is not hitting the screen squarely.	Adjust the projecting direction so that the light hits the screen squarely.	<a href="#">18</a>
	• The “Brightness”, “Contrast”, “Sharpness” or “Phase” adjustments are not correct.	Make the “Picture” adjustments.	<a href="#">46</a>
The picture is dim.	• The “Brightness” or “Contrast” adjustments are not correct.	Make the “Picture” adjustments.	<a href="#">46</a>
	• The lamp life is ending.	Replace the lamp.	<a href="#">65</a>
The color is faint. The tint is not good.	• The “Color”, “Tint”, “R-Level”, “G-Level” or “B-Level” adjustments are not correct.	Make the “Color” adjustments.	<a href="#">48</a>
	• The lamp life is ending.	Replace the lamp.	<a href="#">65</a>

# Before calling service personal (continued)

Symptom	Cause	Correction	Page
The remote control does not work.	• The remote control is not facing the remote sensor.	Face the remote control transmitter toward the remote sensor on the projector.	<a href="#">16</a>
	• The remote control is too far away.	Operate within about 5 meters.	<a href="#">16</a>
	• There is an obstruction between the remote control and the remote sensor.	Remove the obstacle.	–
	• The batteries are exhausted.	Replace the batteries.	<a href="#">15</a>
The presentation made cannot be used from the remote control unit.	• The USB cable is not properly connected.	Connect the USB cable properly.	<a href="#">41</a>
	• The computer or OS is not compatible.	The remote control mouse function is not available.	–
	• The batteries are exhausted.	Replace the batteries.	<a href="#">15</a>
Document camera image is blurry.	• The lens is dirty.	Clean the lens with a blower or lens cleaner, etc.	<a href="#">64</a>
	• The picture is out of focus.	Focus the picture by turning the focus ring.	<a href="#">57</a>
	• The light is not on.	Turn on the light.	<a href="#">56</a>
Document camera image flickers.	• Image is being affected by fluorescent light in the room.	Set the shutter speed on the menu screen.	<a href="#">45</a>

COMPUTER IN  
COMPUTER OUT

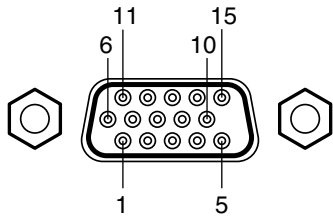

Input signal  
Analog R, G, B signal: 0.7V(p-p) 75Ω  
Horizontal sync signal:  
TTL level (positive/negative polarity)  
Vertical sync signal:  
TTL level (positive/negative polarity)  
Y signal: 1.0V(p-p) 75Ω  
P<sub>B</sub>, P<sub>R</sub> signal: 0.7V(p-p) 75Ω

Mini D-sub 15pin connector

Pin No.	Description	
	RGB input	Y/P <sub>B</sub> /P <sub>R</sub> input
1	Video signal (Red)	Color difference signal (P <sub>R</sub> )
2	Video signal (Green)	Luminance signal (Y)
3	Video signal (Blue)	Color difference signal (P <sub>B</sub> )
4	GND	*
5	GND	*
6	GND (Red)	GND (P <sub>R</sub> )
7	GND (Green)	GND (Y)
8	GND (Blue)	GND (P <sub>B</sub> )
9	N.C	*
10	GND	*
11	GND	*
12	DDC data	*
13	Horizontal sync signal	*
14	Vertical sync signal	*
15	DDC clock	*

\* : Do not connect anything.

## Applicable computer signal

The unit is applicable to the following signals. However, some computers may have different timings than those in the chart. Make the necessary adjustments if the picture has flickers or is blurred.

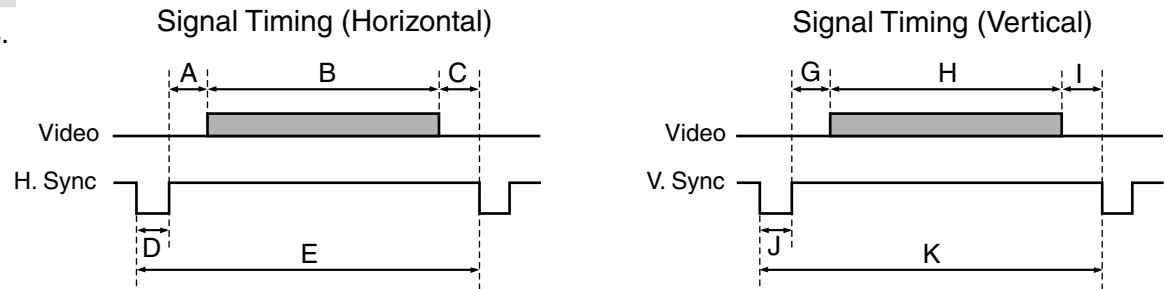

Timing chart

Mode	Resolution	A (Pixels)	B (Pixels)	C (Pixels)	D (Pixels)	E (Pixels)	fh (kHz)	fv (Hz)	Clock (MHz)	G (Lines)	H (Lines)	I (Lines)	J (Lines)	K (Lines)
TEXT70	640 x 350	50	640	14	96	800	31.469	70.086	25.175	59	350	38	2	449
TEXT70	640 x 400	50	640	14	96	800	31.469	70.086	25.175	34	400	13	2	449
TEXT85	640 x 350	96	640	32	64	832	37.861	85.080	31.500	60	350	32	3	445
TEXT85	640 x 400	96	640	32	64	832	37.861	85.080	31.500	41	400	1	3	445
NEC PC98 24k	640 x 400	85	640	59	64	848	24.820	55.900	21.047	25	400	11	8	444
VGA60	640 x 480	48	640	16	96	800	31.469	59.940	25.175	33	480	10	2	525
VGA72	640 x 480	128	640	24	40	832	37.861	72.809	31.500	28	480	9	3	520
VGA75	640 x 480	120	640	16	64	840	37.500	75.000	31.500	16	480	1	3	500
VGA85	640 x 480	80	640	56	56	832	43.269	85.008	36.000	25	480	1	3	509
MAC13"	640 x 480	96	640	64	64	864	35.000	66.667	30.240	39	480	3	3	525
SVGA56	800 x 600	128	800	24	72	1024	35.156	56.250	36.000	22	600	1	2	625
SVGA60	800 x 600	88	800	40	128	1056	37.879	60.317	40.000	23	600	1	4	628
SVGA72	800 x 600	64	800	56	120	1040	48.077	72.188	50.000	23	600	37	6	666
SVGA75	800 x 600	160	800	16	80	1056	46.875	75.000	49.500	21	600	1	3	625
SVGA85	800 x 600	152	800	32	64	1048	53.674	85.061	56.250	27	600	1	3	631
*MAC16"	832 x 624	216	832	40	64	1152	49.725	74.550	57.283	39	632	1	3	667
*XGA43i	1024 x 768	56	1024	8	176	1264	35.522	43.479	44.900	20	768	0	4	817
*XGA60	1024 x 768	160	1024	24	136	1344	48.363	60.004	65.000	29	768	3	6	806
*XGA70	1024 x 768	144	1024	24	136	1328	56.476	70.069	75.000	29	768	3	6	806
*XGA75	1024 x 768	176	1024	16	96	1312	60.023	75.029	78.750	28	768	1	3	800
*XGA85	1024 x 768	208	1024	48	96	1376	68.677	84.997	94.500	36	768	1	3	808
*MAC19"	1024 x 768	180	1024	20	96	1320	60.197	74.872	73.200	30	768	3	3	804

## Timing chart (Continued)

Mode	Resolution	A (Pixels)	B (Pixels)	C (Pixels)	D (Pixels)	E (Pixels)	fh (kHz)	fv (Hz)	Clock (MHz)	G (Lines)	H (Lines)	I (Lines)	J (Lines)	K (Lines)
**SXGA1152x864 75Hz	1152 x 864	256	1152	64	128	1600	67.500	75.000	108.000	32	864	1	3	900
**SXGA1280x960 60Hz	1280 x 960	312	1280	96	112	1800	60.000	60.000	108.000	36	960	1	3	1000
**SXGA1280x960 85Hz	1280 x 960	224	1280	64	160	1728	85.938	85.002	148.500	47	960	1	3	1011
**SXGA1280x1024 60Hz	1280 x 1024	248	1280	48	112	1688	63.981	60.020	108.000	38	1024	1	3	1066
**SXGA1280x1024 75Hz	1280 x 1024	248	1280	16	144	1688	79.976	75.025	135.000	38	1024	1	3	1066
**SXGA1280x1024 85Hz	1280 x 1024	224	1280	64	160	1728	91.146	85.024	157.500	44	1024	1	3	1072
**UXGA60	1600 x 1200	304	1600	64	192	2160	75.000	60.000	162.000	46	1200	1	3	1250
**UXGA65	1600 x 1200	304	1600	64	192	2160	81.250	65.000	175.500	46	1200	1	3	1250
**UXGA70	1600 x 1200	304	1600	64	192	2160	87.500	70.000	189.000	46	1200	1	3	1250
**UXGA75	1600 x 1200	304	1600	64	192	2160	93.750	75.000	202.500	46	1200	1	3	1250

### Notes

- Signal sources marked “\*” and “\*\*” are displayed in compressed format (“\*”: TLP260/TLP261, “\*\*”: TLP260/TLP261/TLP560/TLP561), so some of their data may be missing or their picture quality may be degraded.
- With analog RGB inputs, if the signal source’s dot clock frequency exceeds 165 MHz, some pixel signals cannot be sampled.

### The compatible Video and S-Video signal

Mode	fh (kHz)	fv (Hz)	fsc (MHz)
NTSC	15.73	60	3.58
PAL	15.63	50	4.43
SECAM	15.63	50	4.25 or 4.41
PAL-M	15.73	60	3.58
PAL-N	15.63	50	3.58
PAL-60	15.73	60	4.43
NTSC4.43	15.73	60	4.43

### The compatible components video signal (Y/P<sub>B</sub>/P<sub>R</sub>)

Mode	fh (kHz)	fv (Hz)
480i (525i)	15.73	59.94
480p (525p)	31.47	59.94
575i (625i)	15.63	50.00
720p (750p)	45.00	60.00
1080i (1125i)	33.75	60.00

# Controlling the projector by using RS-232C

You can also control the projector by entering the command from a computer via RS-232C.

## Signal assignment of RS-232C

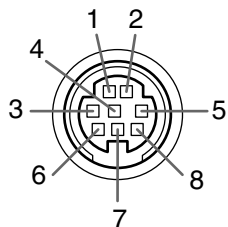

CONTROL RS-232C

Pin No.	Signal	Description
1	RXD	Receiving data
2	CTS	Consent to send
3	DSR	Data set ready
4	GND	Signal ground
5	RTS	Request to send
6	N.C	No connection
7	TXD	Sending data
8	N.C	No connection

## Interface format

1	Communication method	RS-232C 9600 bps, No parity, Data length: 8 bits, Stop bit: 1 bit
2	Communication format	<b>STX (02h)</b>   <b>Command (3Byte)</b>   <b>ETX (03h)</b> One command only can be used per communication.
3	Data format	Commands shall be composed of alphanumeric characters of ASCII description. Use only capital letters.
4	Return value	Acknowledge <b>ACK (06h)</b> Not Acknowledge <b>NAK (15h)</b>

## Command list

Classification	Items/Status	Selection Command	Adjustment Command	Analog RGB	Video	S-Video	Y/Pb/Pr	Camera	
Power	On	PON	-	Yes	Yes	Yes	Yes	Yes	
	Off (with confirmation message)	POF	-	Yes	Yes	Yes	Yes	Yes	
	Shut Down (without confirmation message)	PSD	-	Yes	Yes	Yes	Yes	Yes	
Normal (RS-232C Condition Display Off)		DOF	-	Yes	Yes	Yes	Yes	Yes	
Picture	Contrast	VCN	Yes	Yes	Yes	Yes	Yes	Yes	
	Brightness	VBR	Yes	Yes	Yes	Yes	Yes	Yes	
	Sharpness	VSH	Yes	-	Yes	Yes	Yes	Yes	
	Camera gain	Increase	CGU	-	-	-	-	-	Yes
		Decrease	CGD	-	-	-	-	-	Yes
	Picture mode	Bright	MVB	-	Yes	-	-	-	-
True color		MVP	-	Yes	-	-	-	-	

### Notes

- When commands are transmitted serially, wait for the reply of the projector (acknowledge or not acknowledge) before sending the next command.
- Adjustment commands include "ARG" (increase adjustment value) and "ALF" (decrease adjustment value). For usable items (marked "Yes"), send after the selection command.
- The "Yes" marks in the input source columns indicate that that command can be used.



# Controlling the projector by using RS-232C (continued)

Classification	Items/Status	Selection Command	Adjustment Command	Analog RGB	Video	S-Video	Y/PB/PR	Camera	
Picture (Continued)	Video mode	Auto.	KV0	-	-	Yes	Yes	-	-
		NTSC	KV1	-	-	Yes	Yes	-	-
		PAL	KV2	-	-	Yes	Yes	-	-
		SECAM	KV3	-	-	Yes	Yes	-	-
		PAL-N	KV4	-	-	Yes	Yes	-	-
		PAL-M	KV5	-	-	Yes	Yes	-	-
		PAL60	KV6	-	-	Yes	Yes	-	-
		NTSC4.43	KV7	-	-	Yes	Yes	-	-
	Signal format	Auto.	SG0	-	-	-	-	Yes	-
		480i (525i)	SG1	-	-	-	-	Yes	-
		480p (525p)	SG2	-	-	-	-	Yes	-
		575i (625i)	SG3	-	-	-	-	Yes	-
		720p (750p)	SG4	-	-	-	-	Yes	-
		1080i (1125i)	SG5	-	-	-	-	Yes	-
	Shutter	Auto.	CSA	-	-	-	-	-	Yes
		50Hz	CS0	-	-	-	-	-	Yes
		60Hz	CS1	-	-	-	-	-	Yes
	Screen size	Full	MSF	-	Yes	Yes	Yes	Yes	Yes*1
		Thru	MST	-	Yes	Yes	Yes	Yes	Yes*1
		Wide	MSW	-	-	Yes	Yes	Yes	-
	Picture reset		DRV	-	Yes	Yes	Yes	Yes	Yes
Position	H-position	PHP	Yes	Yes	-	-	-	-	
	V-position	PVP	Yes	Yes	-	-	-	-	
	Phase	PPH	Yes	Yes	-	-	-	-	
	Frequency	PCK	Yes	Yes	-	-	-	-	
	Position reset	DRP	-	Yes	-	-	-	-	
Color	Color	VCL	Yes	-	Yes	Yes	Yes	-	
	Tint	VTN	Yes	-	Yes*2	Yes*2	-	-	
	R-level	VLR	Yes	Yes	Yes	Yes	Yes	Yes	
	G-level	VLG	Yes	Yes	Yes	Yes	Yes	Yes	
	B-level	VLB	Yes	Yes	Yes	Yes	Yes	Yes	
	Color reset	DRC	-	Yes	Yes	Yes	Yes	Yes	

\*1 Not possible for TLP561. \*2 Not possible for PAL/SECAM.

# Controlling the projector by using RS-232C (continued)

Classification	Items/Status		Selection Command	Adjustment Command	Analog RGB	Video	S-Video	Y/PB/PR	Camera
Audio	Volume	Increase	VLU	-	Yes	Yes	Yes	Yes	-
		Decrease	VLD	-	Yes	Yes	Yes	Yes	-
	Speaker output	On	AS1	-	Yes	Yes	Yes	Yes	-
		Off	AS0	-	Yes	Yes	Yes	Yes	-
	Channel select	L+R	AMA	-	Yes	Yes	Yes	Yes	-
		L	AML	-	Yes	Yes	Yes	Yes	-
		R	AMR	-	Yes	Yes	Yes	Yes	-
	Loudness	Off	LM0	-	Yes	Yes	Yes	Yes	-
		On	LM1	-	Yes	Yes	Yes	Yes	-
	Audio reset			DRA	-	Yes	Yes	Yes	Yes
Display	Keystone		PKV	Yes	Yes	Yes	Yes	Yes	Yes
	Keystone reset		DRK	-	Yes	Yes	Yes	Yes	Yes
	Language	English	LEN	-	Yes	Yes	Yes	Yes	Yes
		French	LFR	-	Yes	Yes	Yes	Yes	Yes
		German	LGR	-	Yes	Yes	Yes	Yes	Yes
		Italian	LIT	-	Yes	Yes	Yes	Yes	Yes
		Spanish	LSP	-	Yes	Yes	Yes	Yes	Yes
		Portuguese	LPO	-	Yes	Yes	Yes	Yes	Yes
		Japanese	LJP	-	Yes	Yes	Yes	Yes	Yes
		Chinese(Simplified)	LPK	-	Yes	Yes	Yes	Yes	Yes
		Chinese(Traditional)	LKT	-	Yes	Yes	Yes	Yes	Yes
	Korean		LKK	-	Yes	Yes	Yes	Yes	Yes
	Icon	On	MO0	-	Yes	Yes	Yes	Yes	Yes
		Off	MO1	-	Yes	Yes	Yes	Yes	Yes
	Menu position	Upper left	MP1	-	Yes	Yes	Yes	Yes	Yes
		Bottom left	MP2	-	Yes	Yes	Yes	Yes	Yes
		Upper right	MP3	-	Yes	Yes	Yes	Yes	Yes
		Bottom right	MP4	-	Yes	Yes	Yes	Yes	Yes
	Menu translucent	On	MB1	-	Yes	Yes	Yes	Yes	Yes
		Off	MB0	-	Yes	Yes	Yes	Yes	Yes
	Display reset (except keystone)			DRD	-	Yes	Yes	Yes	Yes

# Controlling the projector by using RS-232C (continued)

Classification	Items/Status		Selection Command	Adjustment Command	Analog RGB	Video	S-Video	Y/PB/PR	Camera		
Default setting	Input source setting	COMPUTER	On	I10	-	Yes	Yes	Yes	Yes	Yes	
			Off	I11	-	Yes	Yes	Yes	Yes	Yes	Yes
			Analog RGB	IS0	-	Yes	Yes	Yes	Yes	Yes	Yes
			Y/PB/PR	IS1	-	Yes	Yes	Yes	Yes	Yes	Yes
		VIDEO	On	I30	-	Yes	Yes	Yes	Yes	Yes	Yes
			Off	I31	-	Yes	Yes	Yes	Yes	Yes	Yes
		S-VIDEO	On	I40	-	Yes	Yes	Yes	Yes	Yes	Yes
			Off	I41	-	Yes	Yes	Yes	Yes	Yes	Yes
		CAMERA	On	I60	-	Yes	Yes	Yes	Yes	Yes	Yes
			Off	I61	-	Yes	Yes	Yes	Yes	Yes	Yes
		Projection mode	Standard	PJ0	-	Yes	Yes	Yes	Yes	Yes	Yes
			Rear	PJ1	-	Yes	Yes	Yes	Yes	Yes	Yes
	Ceiling		PJ2	-	Yes	Yes	Yes	Yes	Yes	Yes	
	Rear ceiling		PJ3	-	Yes	Yes	Yes	Yes	Yes	Yes	
	No signal background	Logo	BG0	-	Yes	Yes	Yes	Yes	Yes	Yes	
		Blue background	BG1	-	Yes	Yes	Yes	Yes	Yes	Yes	
		Non	BG2	-	Yes	Yes	Yes	Yes	Yes	Yes	
	No signal power off	Off	PN0	-	Yes	Yes	Yes	Yes	Yes	Yes	
		5 min.	PN1	-	Yes	Yes	Yes	Yes	Yes	Yes	
	Power on	Manual	AP0	-	Yes	Yes	Yes	Yes	Yes	Yes	
		Auto.	AP1	-	Yes	Yes	Yes	Yes	Yes	Yes	
	Startup screen	On	MS0	-	Yes	Yes	Yes	Yes	Yes	Yes	
		Off	MS1	-	Yes	Yes	Yes	Yes	Yes	Yes	
	Default setting initialize			DRI	-	Yes	Yes	Yes	Yes	Yes	
	Reset	Reset all		DRS	-	Yes	Yes	Yes	Yes	Yes	
	Status display (CALL)			DON	-	Yes	Yes	Yes	Yes	Yes	
	Input selection	Toggle		IN0	-	Yes	Yes	Yes	Yes	Yes	
COMPUTER		IN1	-	Yes	Yes	Yes	Yes	Yes			
VIDEO		IN3	-	Yes	Yes	Yes	Yes	Yes			
S-VIDEO		IN4	-	Yes	Yes	Yes	Yes	Yes			
CAMERA		IN6	-	Yes	Yes	Yes	Yes	Yes			

# Controlling the projector by using RS-232C (continued)

Classification	Items/Status		Selection Command	Adjustment Command	Analog RGB	Video	S-Video	Y/PB/PR	Camera
RESIZE	Increase the enlargement ratio		RUP	-	Yes	Yes	Yes	Yes	Yes
	Decrease the enlargement ratio (Minimum: reset status)		RDW	-	Yes	Yes	Yes	Yes	Yes
	Move the enlargement section	Up	PO1	-	Yes	Yes	Yes	Yes	Yes
		Down	PO2	-	Yes	Yes	Yes	Yes	Yes
		Left	PO3	-	Yes	Yes	Yes	Yes	Yes
		Right	PO4	-	Yes	Yes	Yes	Yes	Yes
Enlargement reset		RS0	-	Yes	Yes	Yes	Yes	Yes	
FREEZE	On		FON	-	Yes	Yes	Yes	Yes	Yes
	Off		FOF	-	Yes	Yes	Yes	Yes	Yes
MUTE	On		MON	-	Yes	Yes	Yes	Yes	Yes
	Off		MOF	-	Yes	Yes	Yes	Yes	Yes
PIP	On		PIN	-	Yes	-	-	-	-
	Off		PIF	-	Yes	-	-	-	-
	PIP input source	Video	PI0	-	Yes	-	-	-	-
		S-Video	PI1	-	Yes	-	-	-	-
	PIP size	Small	PS0	-	Yes	-	-	-	-
		Middle	PS1	-	Yes	-	-	-	-
		Large	PS2	-	Yes	-	-	-	-
	PIP position	Upper left	PP0	-	Yes	-	-	-	-
		Upper right	PP1	-	Yes	-	-	-	-
		Lower left	PP2	-	Yes	-	-	-	-
Lower right		PP3	-	Yes	-	-	-	-	
PIP reset		DRW	-	Yes	-	-	-	-	
AUTO SET			PAT	-	Yes	-	-	-	
Camera	Shortcut		CDR	-	Yes	Yes	Yes	Yes	Yes
	Auto. W/B	On	CW1	-	-	-	-	-	Yes
		Off	CW0	-	-	-	-	-	Yes
	Lighting	On	CL1	-	-	-	-	-	Yes
		Off	CL0	-	-	-	-	-	Yes

## Main unit

Power consumption	TLP560/TLP260: 240W (Standby: 15W) TLP561/TLP261: 250W (Standby: 15W)
Mass	TLP560/TLP260: 3.7kg TLP561/TLP261: 4.3kg
Dimensions (Except the protrusion parts)	TLP560/TLP260: 260 x 95.5 x 295 (mm) (W/H/D) TLP561/TLP261: 260 x 95.5 x 352 (mm) (W/H/D)
Cabinet Material	PC+ABS resin and ABS resin
Ambient environment	Temperature : 0 deg. to 35 deg. Humidity : 30% to 70% RH
Lamp	High pressure mercury lamp
Projection screen size	30 to 180 inches
Projection distance	0.70 to 3.63m
Speaker	1W (monaural)
Connectors	
• COMPUTER IN	Mini D-sub 15-pin Analog RGB/Y/P <sub>B</sub> /P <sub>R</sub> (combination)
• COMPUTER OUT	Mini D-sub 15-pin Analog RGB/Y/P <sub>B</sub> /P <sub>R</sub> (combination)
• S-VIDEO IN	Mini DIN 4-pin
• VIDEO IN	1V(p-p), 75Ω, RCA pin jack
• AUDIO IN	1.3V(rms), more than 22kΩ, ø3.5mm stereo mini jack
• CONTROL	Mini DIN 8-pin (RS-232C)
• USB	Type B

## Liquid crystal display

Projection system	3-panel transmission
Panel size	0.7 inches
Driving system	TFT active matrix
Picture elements	
TLP560/TLP561:	786,432 pixels (1024 x 768 dots) (H./V.) x 3
TLP260/TLP261:	480,000 pixels (800 x 600 dots) (H./V.) x 3

## Projection lens

Lens	Zooming lens F=2.0 to 2.4 f=14.5 to 17.4mm
Focusing	Manual operation
Zooming	Manual operation

## Document imaging camera (with camera model)

Lens	F = 2.8, f = 3.4mm
Focusing	Manual operation
Zoom	None (adjusted by distance to subject)
Iris	Auto./Manual
Image element	1/3 inch CCD
Effective pixels for pickup section	805,486 pixels (1034 x 779 dots) (H./V.)
Lighting	LED light (class 2)

## Sold separately

Replacement lamp TLPL55

- The design and specifications are subject to change without notice.

---

### Trademarks

NEC, PC-98 series are trademarks of NEC Corporation.

VGA, SVGA, XGA, SXGA, UXGA are trademarks or registered trademarks of International Business Machines Corporation.

Macintosh is a registered trademark of Apple Computer, Inc.

Windows is a registered trademark of Microsoft Corporation in the U.S. and other countries.

Display Data Channel is a trademark of Video Electronics Standard Association.