

iHome®

Model iHM45
**Portable Charging
Alarm Clock Speaker**

For your iPod/iPhone/smartphone/ tablet



Questions? For latest instructions, visit www.ihomeaudio.com/support

Table of Contents

Package contains	1
Controls and Indicators	2
Quick Start	3
iHM45 Display	4
Install Clock Backup Battery	4
Using iHM45	5
Charging your Audio Device	5
Listening to your Audio Device	6
Clock Setting	6
Alarm Operation	7
Snooze/Dimmer Operation	8
A Consumer Guide to Product Safety	9
Trouble Shooting	10
Warranty Information	11

Maintenance

- Place the unit on a level surface away from sources of direct sunlight or excessive heat.
- Protect your furniture when placing your unit on a natural wood and lacquered finish. A cloth or other protective material should be placed between it and the furniture.
- Clean your unit with a soft cloth moistened only with mild soap and water. Stronger cleaning agents, such as Benzine, thinner or similar materials can damage the surface of the unit.

NOTE: Be careful not to touch the surface of the speakers at either end of the unit.

Getting Started

Thank you for purchasing the iHome iHM45 Audio Speaker System for your audio device. Designed to work with most audio devices, this system provides high quality audio performance that brings out the best in your music.

Please read this instruction book carefully before operating the iHM45 and keep it for future reference.

FCC Information

This device complies with Part 15 of the FCC Rules. Operation is subject to the following two conditions: (1) This device may not cause harmful interference, and (2) this device must accept any interference received, including interference that may cause undesired operation.

Warning: Changes or modifications to this unit not expressly approved by the party responsible for compliance could void the user's authority to operate the equipment.

NOTE: This equipment has been tested and found to comply with the limits for a Class B digital device, pursuant to Part 15 of the FCC Rules. These limits are designed to provide reasonable protection against harmful interference in a residential installation. This equipment generates, uses and can radiate radio frequency energy and, if not installed and used in accordance with the instructions, may cause harmful interference to radio communications. However, there is no guarantee that interference will not occur in a particular installation. If this equipment does cause harmful interference to radio or television reception, which can be determined by turning the equipment off and on, the user is encouraged to try to correct the interference by one or more of the following measures:

- Reorient or relocate the receiving antenna.
- Increase the separation between the equipment and receiver.
- Connect the equipment into an outlet on a circuit different from that to which the receiver is connected.
- Consult the dealer or an experienced radio/TV technician for help.

This Class B digital apparatus complies with Canadian ICES-003.

Battery Warning

For models that use Lithium batteries

- Lithium batteries can explode or cause burns if disassembled, shorted, recharged, exposed to water, fire, or high temperatures & not handled appropriately.
- Do not place loose batteries in a pocket, purse, or other container containing metal objects, do not mix with used or other battery types, or store with hazardous or combustible materials.
- Store in cool, dry, ventilated area.
- Follow applicable laws and regulations for transport and disposal.

For models that require more than one battery

- Do not mix with used or other battery types/brands
- Replace all batteries at the same time
- Do not open batteries
- Do not dispose of in fire
- Do not heat above 75°C (167°F)
- Do not expose contents to water
- Do not charge or recharge
- Do not install backwards

package contains

- ① iHM45 system
- ② micro USB charging cable
- ③ 3.5mm audio input cable
- ④ universal voltage adaptor (100-240 volts, 50/60 Hz)

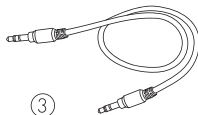
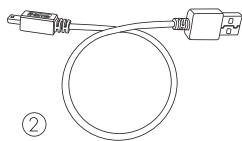
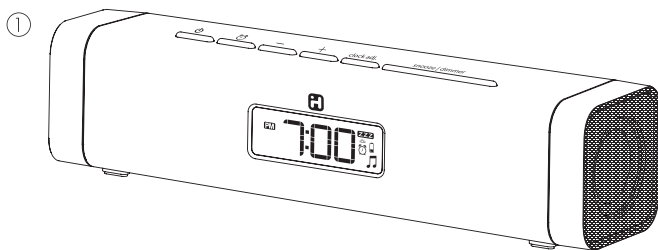

Controls and Indicators

Top Panel

+ Button

Raise volume, Adjust clock/alarm time forward

- Button

Lower volume, Adjust clock/alarm time backward

Power Button

Press to power unit ON or OFF

Alarm Button

Press and hold for Alarm Setting mode

Clock Adj. Button

Press and hold for Clock Adjust mode

Snooze/Dimmer Button

Silence alarm temporarily or adjust display brightness

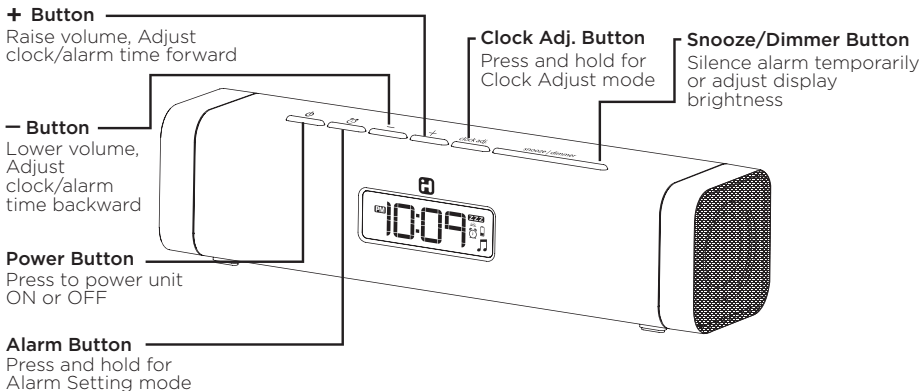

Back Panel

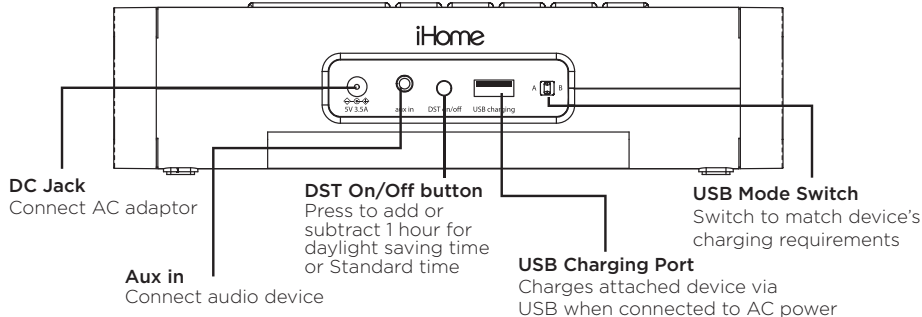

Quick Start

1: power

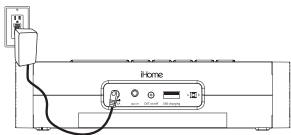

Attach the AC adaptor cable to the DC jack on the back of the iHM45 and plug the other end into a working wall socket. For portable operation, remove battery compartment door on the bottom of the unit and insert 4 AA batteries (see diagram on page 5).

2: audio device

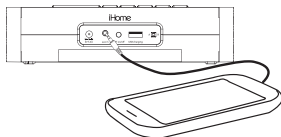

Connect one end of the included stereo audio cable with 3.5 mm plugs to the headphone jack on your audio device and the other end to the **aux in jack** on the back of the unit. Press the **Power Button** on the iHM45. Put your audio device in play mode. Press the **+ or - Button** on the iHM45 to adjust the system volume.

3: time



To set time

- Press the **DST On/Off Button** on the back of the unit as needed to add or subtract an hour for daylight saving time or standard time.
- Press & hold the **Clock Adj. Button** on the top of the unit until the hour display flashes.
- Press the **+ or - buttons** to set the hour, then press the **Clock Adj. button**
- Press the **+ or - buttons** to set the minutes then press the **Clock Adj. Button** again to confirm time setting. 2 beeps will sound.

iHM45 Display

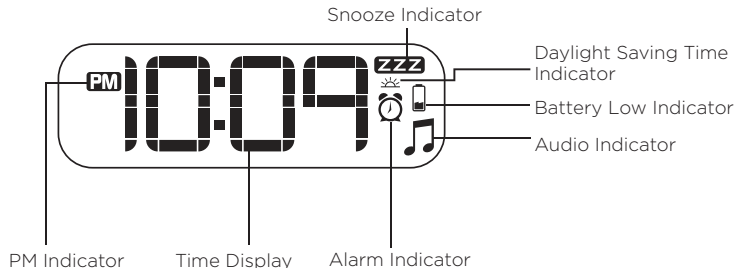

Install Clock Backup Battery

The iHM45 uses a CR2032 button cell battery (included with instructions) to keep alarm and clock settings in the event of a power failure and 4 "AA" batteries to maintain alarm operation.

If the Backup Battery has been installed and a power failure occurs or the AC adaptor is accidentally disconnected, the display backlight will not remain lit, but current time and alarm time settings will be temporarily maintained. Otherwise, you must reset the time and alarm settings. If 4 "AA" batteries are installed, alarm will operate when unit is not connected to AC adaptor.

1. Please make sure the AC adaptor is connected. Otherwise all settings may be lost during battery replacement.
2. Open and remove the battery compartment door located on the bottom of the unit.
3. Pinch the backup battery release tab and pull the backup battery holder free.
4. Insert one CR2032 button cell battery with the + side facing upwards.
5. Replace the backup battery holder into the unit, then replace the battery compartment door.

Notes:

- Make sure you dispose of battery properly (see your local regulations).
- Buttons will not function if only back up battery installed.
- Replace the CR2032 battery when you see the Low Battery indicator flashing in the display.

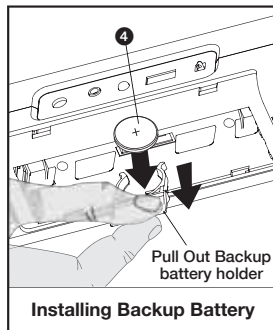

Using iHM45

Install AC Adaptor

Connect the AC adaptor cable plug into the DC jack on the back of the iHM45, then plug the AC adaptor into the wall outlet.

Installing/Replacing Batteries for Portable Operation

The iHM45 uses 4 “AA” batteries for portable operation. The iHM45 will not charge your audio device while operating on batteries.

If sound becomes weak or distorted, it is time to replace the batteries.

- Open the battery compartment cover located on the bottom of the unit.

- Insert 4 “AA” batteries as indicated. Replace battery compartment cover.
- We recommend the use of alkaline batteries for longer life.

NOTE: To save battery life, when running on batteries, unit will automatically power OFF after 3 minutes of non-use (no song playing).
Batteries information:

- Do not mix alkaline, standard (carbon-zinc) or rechargeable (nickel-cadmium) batteries.

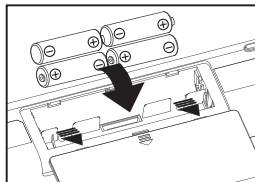
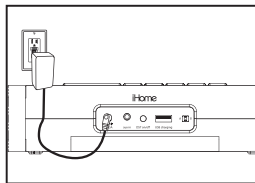

Charging Your Audio Device

A micro USB to standard USB charging cable is included with the unit. Connect your audio device to the included micro USB plug and connect the standard USB plug into the USB charging port on the back of the unit. If your device requires a different USB charging cable, please use the cable that came with your device instead. Move the USB Mode Switch to the B position. Observe the charging status on your device. If device does not charge, try the A position.

While your device is connected to the USB Port in the unit and the unit is connected to AC power, it recharges until fully charged. Device will not be overcharged. **Unit will not charge devices when operating on batteries.**

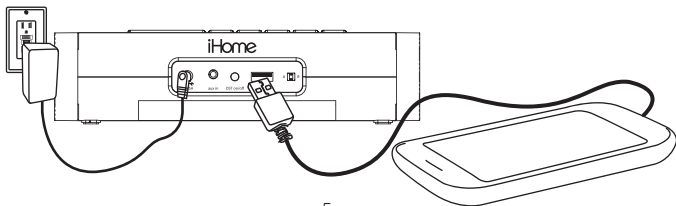

Listening to Your Audio Device

1. Connect the included stereo audio cable to the output/headphone jack on your audio device and the other end to the **aux in jack** located on the back of the unit.
2. Press the **⏻ Button** on the iHM45. The Audio Indicator (🎵) appears in the display.
3. Place your audio device in play mode. Use the transport controls on your audio device for playing/pausing, scanning and skipping tracks, etc.
4. Press the **+ or - buttons** on the iHM45 to adjust the system volume.
5. To turn off the unit, press the **⏻ Button** on the iHM45. Remember to turn off your audio device, too.

Note: If your audio device is in pause mode over 3 minutes the unit will power off automatically.

6. The Audio Indicator (🎵) disappears.

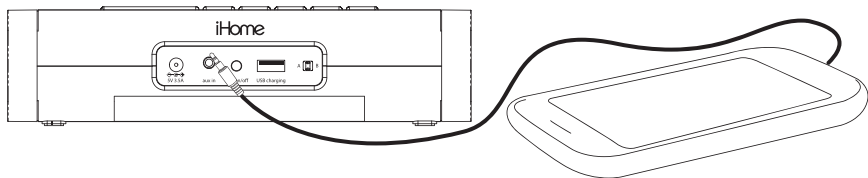

Clock Setting

Setting the Time



1. Press the **DST Button** located on the back of the unit to add one hour for daylight saving time (on) or to subtract one hour for standard time (off). The ☀ icon will appear on the display to indicate DST is on.
2. Press and hold the **Clock Adj. Button** for 2 seconds until the hour display flashes. Press the **+ or - Button** until the current hour is displayed. Remember to set the correct AM or PM time (a PM icon to the left of the time display is the PM indicator; there is no AM indicator).
3. Press the **Clock Adj. Button** again. The minute display will flash. Press the **+ or - Button** until the current minute is displayed. Hold for rapid advance.
4. Press the **🕒 Button** during time setting to toggle 12-hour or 24-hour display format. Note that the PM indicator will not appear when using 24 hour display mode.
5. Press the **Clock Adj. Button** again to confirm the clock setting. You will hear 2 beeps indicating the clock time is set.



Alarm Operation



Note: In order for the alarm to operate you must install the 4 "AA" batteries or have the AC adaptor connected. The CR2032 back up battery will maintain the time and alarm settings but it will not turn on the alarm.

This unit features Gentle Waking, which gradually increases the volume of the alarm.

Setting the Alarm

1. Press and hold the  **Button** until the hour display flashes. Press the **+** or **- Button** until the desired alarm hour is displayed. Remember to set the correct AM or PM time, indicated by PM on the display; there is no AM indicator.
2. Press the  **Button** again, then press the **+** or **- Button** until the desired alarm minute is displayed.
3. Press the  **Button** again to exit the setting mode. You should hear 2 beeps indicating the alarm is set.

Note: Once you set the alarm time, the alarm will be automatically armed, indicated by the  icon. To disarm the alarm, press the  **Button**. The  icon will disappear and the alarm will not sound at the set time.

4. When the alarm is sounding, the  icon will flash.
 - To snooze during the alarm, press the **Snooze/Dimmer Button**. The alarm will be silenced for 9 minutes, then come on again.
 - To turn the alarm off and reset it to come on the next day, press the  **Button**.
5. If the alarm is not turned off once it sounds, it will play for one hour then turn off automatically. This cycle will repeat every 24 hours unless the controls are changed.

Snooze/Dimmer Operation

Programming Snooze Time

The default snooze time is 9 minutes. You can adjust the snooze duration. During normal operation (when alarm is NOT sounding), press and hold the **Snooze/Dimmer Button** for 2 seconds until the **ZZZ** indicator and Snooze time display flashes. Adjust the duration of snooze time up or down (between 1 - 29 minutes) by pressing the **+** or **- Buttons**. Press and hold the **Snooze/Dimmer Button** to confirm.

Using the Snooze/Dimmer Button

1. Press the **Snooze/Dimmer Button** after the alarm sounds. The alarm will be silenced and will come on again after the set snooze duration. You may repeat this cycle several times during the one hour alarm cycle.
2. During normal operation with the AC adaptor, press the **Snooze/Dimmer Button** to control the brightness (high, medium, low and off) of the LCD display. During portable operation with 4 "AA" batteries, the LCD backlight will display for about 5 seconds when you press the **Snooze/Dimmer Button** once.

IMPORTANT SAFETY INSTRUCTIONS

When used in the directed manner, this unit has been designed and manufactured to ensure your personal safety. However, improper use can result in potential electrical shock or fire hazards. Please read all safety and operating instructions carefully before installation and use, and keep these instructions handy for future reference. Take special note of all warnings listed in these instructions and on the unit.

1. **Water and Moisture** - The unit should not be used near water. For example: near a bathtub, washbowl, kitchen sink, laundry tub, swimming pool or in a wet basement.
2. **Ventilation** - The unit should be situated so that its location or position does not interfere with its proper ventilation. For example, it should not be situated on a bed, sofa, rug or similar surface that may block ventilation openings. Also, it should not be placed in a built-in installation, such as a bookcase or cabinet, which may impede the flow of air through the ventilation openings.
3. **Heat** - The unit should be situated away from heat sources such as radiators, heat registers, stoves or other appliances (including amplifiers) that produce heat.
4. **Power Sources** - The unit should be connected to a power supply only of the type described in the operating instructions or as marked on the appliance.
5. **Power-Cable Protection** - Power supply cables should be routed so that they are not likely to be walked on or pinched by items placed upon or against them. It is always best to have a clear area from where the cable exits the unit to where it is plugged into an AC socket.
6. **Cleaning** - The unit should be cleaned only as recommended. See the Maintenance section of this manual for cleaning instructions.
7. **Objects and Liquid Entry** - Care should be taken so that objects do not fall and liquids are not spilled into any openings or vents located on the product.
8. **Attachments** - Do not use attachments not recommended by the product manufacturer.
9. **Lightning and Power Surge Protection** - Unplug the unit from the wall socket and disconnect the antenna or cable system during a lightning storm or when it is left unattended and unused for long periods of time. This will prevent damage to the product due to lightning and power-line surges.
10. **Overloading** - Do not overload wall sockets, extension cords, or integral convenience receptacles as this can result in a risk of fire or electric shock.
11. **Damage Requiring Service** - The unit should be serviced by qualified service personnel when:
 - A. the power supply cable or plug has been damaged.
 - B. objects have fallen into or liquid has been spilled into the enclosure.
 - C. the unit has been exposed to rain.
 - D. the unit has been dropped or the enclosure damaged.
 - E. the unit exhibits a marked change in performance or does not operate normally.
12. **Periods of Nonuse** - If the unit is to be left unused for an extended period of time, such as a month or longer, the power cable should be unplugged from the unit to prevent damage or corrosion.
13. **Servicing** - The user should not attempt to service the unit beyond those methods described in the user's operating instructions. Service methods not covered in the operating instructions should be referred to qualified service personnel.

Questions? Visit www.ihome.com

Trouble Shooting

Symptom	Possible Problem	Solution
Unit doesn't respond (no power)	AC adaptor isn't plugged into a wall outlet or the connector is not plugged into the power supply jack on the back of the unit	Plug the AC adaptor into a wall outlet and plug the connector into the supply jack on the unit.
	Wall outlet is not functioning	Plug another device into the same outlet to confirm the outlet is working. Turn on any switch that controls the outlet.
	Batteries are weak/dead	Replace current batteries with fresh ones
Audio device doesn't charge up	Unit is operating on batteries/ not connected to AC adaptor	Unit will not charge audio device when running on batteries. Connect unit to AC adaptor to charge device.
	USB cable is not properly connected and/or USB Mode Switch needs to be switched	Make sure the USB cable is properly and securely connected to the USB port on the back of the unit. Try moving the USB Mode Switch to a different position.
	Device is locked up/frozen	Please refer to your device's manual for details.
	Device battery has problem	Please make sure your device is working properly before connecting to unit.
Sound is distorted	Volume level is set too high	Decrease the volume.
	Sound source is distorted	If original sound source is poor quality, distortion and noise are easily noticed with high-power speakers. Try a different file from a trusted source such as iTunes.
	Batteries are weak/dead	Replace current batteries with fresh ones.

Limited 1 Year Warranty Information

iHome Products, a division of SDI Technologies Inc. (hereafter referred to as SDI), warrants this product to be free from defects in workmanship and materials, under normal use and conditions, for a period of one (1) year from the date of original purchase.

Should this product fail to function in a satisfactory manner, it is best to first return it to the store where it was originally purchased. Should this fail to resolve the matter and service still be required by reason of any defect or malfunction during the warranty period, SDI will repair or, at its discretion, replace this product without charge. This decision is subject to verification of the defect or malfunction upon delivery of this product to the Factory Service Center authorized by SDI Customer Service. The product must include proof of purchase, including date of purchase. An out-of-warranty fee for service will be charged for units that are received without proof of purchase.

Before returning this product for service, please first replace the batteries (if applicable) with fresh ones, as exhausted or defective batteries are the most common cause of problems encountered.

If service is still required:

1. Call SDI Customer Service at 1-800-288-2792 for Return Authorization and for the address of the Factory Service Center.
2. Remove the batteries (if applicable) and pack the unit in a well padded, heavy corrugated box. SDI is not responsible for damage that occurs during shipping to the Factory Service Center.
3. Enclose a photocopy of your sales receipt, credit card statement, or other proof of the date of purchase, if within the warranty period. Also include your name and address information, a brief description for why the unit is being returned, and the return authorization number. No unit can be processed without a return authorization number.
4. Write the return authorization number on the side of the shipping package and send the unit prepaid and insured to the Factory Service Center address authorized by SDI Customer Service.

Disclaimer of Warranty

NOTE: This warranty is valid only if the product is used for the purpose for which it was designed. It does not cover (i) products which have been damaged by negligence or willful actions, misuse or accident, or which have been modified or repaired by unauthorized persons; (ii) cracked or broken cabinets, or units damaged by excessive heat; (iii) damage to digital media players, CD's or tape cassettes (if applicable); (iv) the cost of shipping this product to the Factory Service Center and its return to the owner.

This warranty is valid only in the United States of America and does not extend to owners of the product other than to the original purchaser. In no event will SDI or any of its affiliates, contractors, resellers, their officers, directors,

shareholders, members or agents be liable to you or any third party for any consequential or incidental damages, any lost profits, actual, exemplary or punitive damages. (Some states do not allow limitations on implied warranties or exclusion of consequential damages, so these restrictions may not apply to you.) This warranty gives you specific legal rights, and you may also have other rights which vary from state to state.

Your acknowledgement and agreement to fully and completely abide by the above mentioned disclaimer of warranty is contractually binding to you upon your transfer of currency (money order, cashier's check, or credit card) for purchase of your SDI product.

**Questions? Visit www.ihome.com
or call 1-800-288-2792 Toll Free**