

OWNER S MANUAL

Model No. MJFP8W and RHFP8B

8 CUP FOOD PROCESSOR



IMPORTANT SAFEGUARDS

When using electrical appliances, basic safety precautions should always be followed including the following:

1. Read all instructions.
2. To protect against risk of electrical shock do not put cord, plugs, or appliance in water or other liquid.
3. Close supervision is necessary when any appliance is used by or near children.
4. Unplug from outlet when not in use, before putting on or taking off parts, and before cleaning.
5. Avoid contacting moving parts.
6. Do not operate any appliance with a damaged cord or plug or after the appliance malfunctions, or is dropped or damaged in any manner. Contact Consumer Service for examination, repair or electrical or mechanical adjustment
7. The use of attachments not recommended or sold by the manufacturer may cause fire, electric shock or injury.
8. Do not use outdoors.
9. Do not let cord hang over edge of table or counter.
10. Do not let cord contact hot surface, including the stove.
11. Keep hands and utensils away from moving blades or discs while processing food to reduce the risk of severe injury to persons or damage to the food processor. A scraper may be used but must be used only when the food processor is not running.
12. Blades are sharp. Handle carefully.
13. To reduce this risk of injury. Never place cutting blade or discs on base without first putting bowl properly in place.
14. Be certain cover is securely locked in place before operating appliance.
15. Never feed food by hand. Always use food pusher.
16. Do not attempt to defeat the cover interlock mechanism.

SAVE THESE INSTRUCTIONS

For Household Use Only.

ADDITIONAL IMPORTANT SAFEGUARDS

1. All users of this appliance must read and understand this Owner s Manual before operating or cleaning this appliance.
2. The cord of this appliance should be plugged into a 120V AC electrical outlet only.
3. Do not leave this appliance unattended during use.
4. If this appliance begins to malfunction during use, immediately turn the unit OFF and unplug the cord. Do not use or attempt to repair the malfunctioning appliance.
5. If this appliance falls or accidentally becomes immersed in water, unplug it immediately. **Do not reach into the water!** Do not use this appliance after it has fallen into or becomes immersed in water.
6. To reduce the risk of injury to persons or property, never use this appliance in an unstable position.
7. Do not use this appliance for other than its intended use.

Polarized Plug

This appliance has a polarized plug (one blade is wider than the other). To reduce the risk of electrical shock, this plug is intended to fit into a polarized outlet only one way. If the plug does not fit fully in the outlet, reverse the plug. If it still does not fit, contact a qualified electrician. Do not attempt to modify the plug in any way.

Short Cord Instructions

A short power-supply cord is provided to reduce the risk resulting from becoming entangled in or tripping over a longer cord.

Do not use an extension cord with this product.

Electric Power

If the electric circuit is overloaded with other appliances, your appliance may not operate properly. It should be operated on a separate electrical circuit from other appliances.

Plasticizer Warning

CAUTION: To prevent Plasticizers from migrating from the finish of the countertop, tabletop or other furniture, place **NON-PLASTIC** coaster or placemats between the appliance and the finish of the countertop, tabletop or other furniture.

Failure to do so may cause the finish to darken, permanent blemishes may occur or stains can appear.

GETTING TO KNOW YOUR 8 CUP FOOD PROCESSOR

PRODUCT MAY VARY SLIGHTLY FROM ILLUSTRATIONS

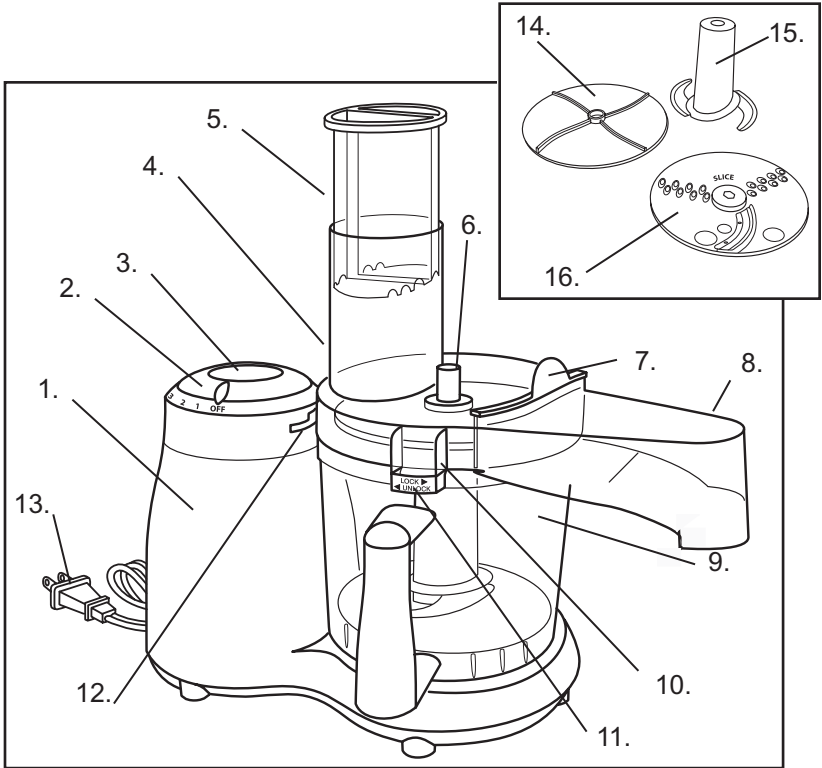

- | | |
|--|---|
| 1. Food Processor Body | 10. Interlock Mechanism |
| 2. 8-Speed Control Dial | 11. Lock Tabs |
| 3. Pulse Button | 12. Latch |
| 4. Lid with Food Chute (P/N 71155) | 13. Cord |
| 5. Food Pusher (P/N 71034) | 14. Discharge Disc
(White: P/N 71037)
(Black: P/N 71037B) |
| 6. Drive Shaft | 15. Chopping Blade
(White: P/N 71038)
(Black: P/N 71038B) |
| 7. Shield
(White: P/N 71035)
(Black: P/N 71035B) | 16. Slicing/Shredding Disc
(White: P/N 71039)
(Black: P/N 71039B) |
| 8. Continuous Flow Side Chute | |
| 9. 8-Cup Processor Bowl
(White: P/N 71036)
(Black: P/N 71036B) | |

Before Using For The First Time

1. Remove all packaging material before using.
2. Wash Lid, Chopping Blade, Processing Bowl, Food Chute, Shield, Food Pusher and Discs, in warm soapy water. Rinse and dry thoroughly, see CARE AND CLEANING.

CAUTION: BLADES ARE SHARP, HANDLE WITH CARE.
CAUTION: DO NOT IMMERSE FOOD PROCESSOR BODY IN WATER OR OTHER LIQUIDS.

Operating Instructions

How to Slice or Shred Food:

1. Attach the 8-Cup Processor Bowl to the Food Processor Body by placing on Drive Shaft. Turn 8-Cup Processor Bowl counter-clockwise until it clicks into place. (See Picture A)

NOTE: For Slicing or Shredding Food the Chopping Blade is not needed.

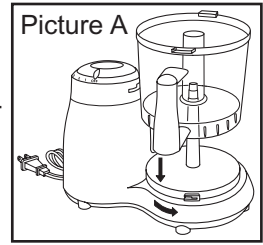

2. Place the Discharge Disc onto the Drive Shaft. (See Picture B)
NOTE: The Discharge Disc is only used when processing out of Continuous Flow Side Chute.

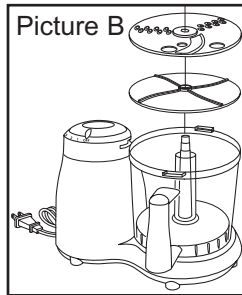

3. Place the Slicing/Shredding Disc on the Drive Shaft. (See Above Picture B)
NOTE: Both sides of the Slicing/Shredding Disc indicate which Function it will perform.

CAUTION: Use extreme care when handling the Slicing/Shredding Disc. Do not touch the cutting edges with your fingers. The cutting edge is very sharp and can cause injury if touched.

Operating Instructions (Cont.)

- Place Lid with Food Chute so each Interlock Mechanism is to the left of the Tabs. Press gently on the Lid, turning counter-clockwise until you hear or feel the Latch lock. Do not force the Interlock Mechanism. (See Pictures C & D)

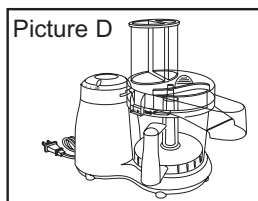
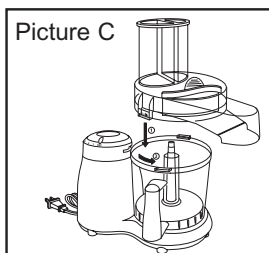

- Make sure unit is in the OFF position. Plug your 8-Cup Food Processor into a 120 V AC electrical outlet.
- Set Speed Control to level 1.
NOTE: To process food into 8-Cup Food Processor make sure that Shield is closed. To process food using the Food Chute make sure the Shield is open, (See Picture E) and place a bowl/ container under the chute to catch processed food.

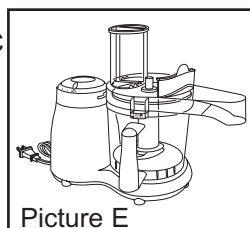

- Using constant, even pressure on the Food Pusher, feed food into the Food Chute. For more power, slowly increase Speed Control from 1 to a higher number or turn to OFF and press Pulse Button. (See Picture F)

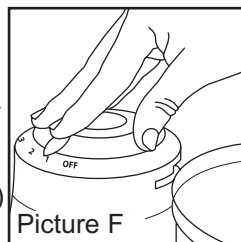

- After processing food, move speed Control Dial to OFF and unplug unit.
- Remove the Lid with Food Chute by turning it clockwise. Carefully remove Slicing/Shredding disc and Discharge disc. Grasp handle of the 8-Cup Processor Bowl and turn clockwise to remove. Clean according to directions under User Maintenance.

How to Chop Food

1. Attach the 8-Cup Processor Bowl to the Food Processor Body by placing on Drive Shaft. Turn 8-Cup Processor Bowl counter-clockwise until it clicks into place. (See Picture A on previous page)
2. Carefully place Chopping Blade on Drive Shaft with the Chopping Blades sliding down first. (See Picture G)

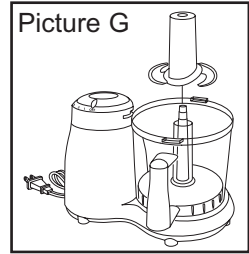

CAUTION: Use extreme care when handling the Blade. Always insert or remove Blade by using the Hub. Do not touch the Blades with your fingers. The Blades are very sharp and can cause injury if touched.

3. Food should be cut into 1/2 to 1 inch pieces, before placing in 8-Cup Food Processor.
4. Place Lid with Food Chute so each Interlock Mechanism is to the left of the Tabs. Press gently on the Lid, turning counter-clockwise until you hear or feel the Latch lock. Do not force the Interlock Mechanism. (See Pictures C & D)
5. Plug your 8-Cup Food Processor into a 120 V AC electrical outlet.
6. Make sure Shield is down. This will keep food in the Food Processor Bowl.
7. Set Speed Control to level 1.
8. For more power, slowly increase Speed Control from 1 to a higher number or turn to OFF position and press Pulse Button. (See Picture F)
9. After chopping food, move Speed Control Dial to OFF and unplug unit.
10. Remove the Lid with Food Chute by turning it clockwise. Carefully remove Chopping Blade from Drive Shaft. Grasp handle of the 8-Cup Processor Bowl and turn clockwise to remove.
11. Clean according to directions under User Maintenance.

Usage Guide

The three functions of your 8-Cup Food Processor allow you to chop, shred or slice a wide variety of food quickly and effortlessly.

BLADE ATTACHMENT	FOODS	RESULTS
Chopping Blade	Bread Carrots Celery Onions Chocolate Garlic Eggs (Hard Boiled) Nuts Parsley, Fresh Herbs Hard Fruits Sauces/Salad Dressings	Crumbs Chopped Chopped/Diced Chopped/Diced Grated Minced Chopped Chopped, Ground Chopped Chopped Blended
Slicing Disc	Apples, Pears Carrots Celery Onions Potatoes	Sliced Sliced Sliced Sliced Sliced
Shredding Disc	Carrots Potatoes Zucchini	Grated Grated Grated

NOTE: Certain foods should not be chopped, shredded or sliced. Avoid slicing raw meat. Attempting to chop ice or to grind coffee beans will damage the Chopping Blade and 8-Cup Processor Bowl. Very hard foods that can not be cut with an ordinary knife blade should be avoided.

Chopping Guide

FOOD	QUANTITY	PREPARATION	APROX. TIME (SECONDS)
Bread	6 slices	Six slices of bread quartered	Pulse 6-8
Parsley/Herbs	Handful	Wash, dry thoroughly	30
Onion	1-2 small	Peel onions, cut into 6-8 pieces	4-6
Garlic	1 or more large cloves	Peel	5-7
Mushrooms	8 oz.	Cut in half	Pulse 5-10
Pepper	1 medium	Clean and quarter to fit Container	Pulse 5-6
Eggs (Hard Boiled)	Up to 12 eggs	Peel, cut into halves	Pulse 12-15
Chocolate Square	1 or 2 pc. 1 oz. Total	Break each square into 1/2 pieces (Pulse until desired texture is reached)	Pulse 6-8
Carrots	3 cups	Peel and cut into 1/4 lengths	Pulse

NOTE: Timing on chart above applies to Speed 4 or Pulse.

Helpful Hints

1. Be careful not to over-process food. Most foods require only 3 to 10 seconds.
2. Process up to 8 cups of food at a time.
3. If food is not chopping into even-sized pieces, remove some of the food from the Processor Bowl and process smaller quantities at a time.
4. Do not attempt to process extremely hard food which are difficult to cut with a kitchen knife.
5. Remove bones, pits and hard shells before processing to avoid damage to the unit.
6. This unit is not designed for processing liquids or foods with a high liquid content.
7. Lift the Chopping Blade out before emptying the contents of the 8- Cup Processor Bowl.

User Maintenance Instructions

Care and Cleaning

This appliance requires little maintenance. It contains no user-serviceable parts. Contact qualified personnel if the product requires servicing.

CAUTION: BLADES AND DISC ARE SHARP, HANDLE WITH CARE.

CAUTION: NEVER PLACE FOOD PROCESSOR BASE IN WATER OR OTHER LIQUIDS.

1. Always unplug the unit before cleaning. Allow Chopping Blade or Disc to stop rotating before disassembling.
2. Remove attachments from Food Processor Body.
3. Wash the 8-Cup Processor Bowl Lid with Food Chute, Food Pusher, Slicing/Shredding Disc, Discharge Disc, Chopping Blade and Shield in warm soapy water. Removable parts may also be placed on the top shelf of your dishwasher.
4. Never immerse the Food Processor body in water or any other liquid. If necessary, wipe exterior surface with a damp cloth or sponge and dry thoroughly.

To Store and Clean

Unplug and clean unit; store in its box or in a clean, dry place. Never store it while it is still plugged in. Never wrap cord tightly around the appliance. Do not put any stress on the cord where it enters the unit, as it could cause the cord to fray and break.

Recipes

Spinach Dip Yield: 4 Cups

5 ounce spinach leaves	2 teaspoon salt
8 ounce water chestnuts, drained	1 teaspoon dried tarragon leaves
1 cup sour cream	1/2 teaspoon dry mustard
1 cup plain yogurt	1/2 teaspoon pepper
2 bunches green onions, cut in 2 inch pieces	2 cloves garlic

Using the chopping blade, chop half each of the spinach and water chestnuts on Speed 5. Remove from bowl and set aside. Repeat for the other half. Add remaining ingredients to bowl and process on Speed 5 until ingredients are chopped and mixed together. Stir all ingredients together. Cover and refrigerate for 2 hours to enhance flavor.

Crab Dip Yield: 4 Cups

8 ounce Crab Delights [®] (imitation crab meat)	2 teaspoons chili sauce
1 medium cucumber peeled	2 teaspoons Worcestershire sauce
11 ounce cream cheese, softened	1/8 teaspoon sugar
1/3 cup mayonnaise	salt and pepper

Using the chopping blade, add all ingredients to bowl and process on Speed 6 until ingredients are chopped and mixed together. Cover and refrigerate for 2 hours to enhance flavor.

Chicken Salad Yield: 4 Servings

1-1/2 cups cooked chicken or turkey; or 6-3/2 ounce cans chunk-style chicken, drained	2 hard-boiled eggs
1 stalk celery	1 sweet pickle
4 green onions	1/3 cup salad dressing salt and pepper

Using the chopping blade, chop the chicken through the pickle on Speed 6 to desired consistency. Stir in remaining ingredients.

Pimento Cheese Spread Yield: 8 Servings

16 ounce Cheddar cheese 2 cups salad dressing
4 ounce pimentos, drained

Using the shredding disk, grate cheese using Speed 8. Remove from bowl. Using chopping blade, chop pimentos on Speed 3. Add cheese and salad dressing and process on Speed 6 until mixed.

Macaroni Salad Yield: 12 Servings

3 cups uncooked elbow macaroni 1/2 cup green peppers
1 tablespoon oil 3 hard-boiled eggs
1/2 cup onions 1/2 cup carrots
1 cup celery

Dressing

1-1/3 cups sugar 1 cup salad dressing
1/2 cup vinegar 1-1/2 teaspoons prepared mustard
2 eggs 1 5-1/3 ounces can evaporated milk
1-1/2 teaspoon salt

Cook macaroni, drain and stir in oil. Using the chopping blade, chop onions, celery, green peppers and eggs on Speed 5 until chopped. Using the shredding disk, grate carrots. Add to macaroni.

To make dressing, combine sugar, vinegar, eggs and salt. Bring to a boil over medium heat, stirring frequently. Cool and stir in rest of dressing ingredients. Pour over macaroni, refrigerate several hours.

Squash Casserole Yield: 6 Servings

1 onion	6 ounces stuffing mix
3 carrots	(chicken or herb)
6 cups unpeeled zucchini or yellow squash	1/2cup butter, melted
1 can cream of chicken soup	
1 cup sour cream	

Temperature: 350°F/177°C

Time: 25-30 minutes

Using the chopping blade, chop onions on Speed 6. Using the shredding disk, shred carrots. Remove carrots and onions from bowl and set aside. Using the slicing disc, slice squash on Speed 8.

Boil vegetables for 5 minutes. Drain and set aside. Combine soup and sour cream. Stir into vegetable. Combine stuffing mix with melted butter and spread half on the bottom of a 9x13-inch greased pan. Spoon vegetable mixture on top and sprinkle with remaining stuffing mix. Bake as directed.

Chicken Pot Pie Yield: 6 Servings

Filling

1 onion	1 stalk celery
4 cups pre-cooked chicken or beef	salt and pepper
6 potatoes, peeled	6 cups chicken broth
6 carrots	2 Tablespoons all purpose flour

Crust

2 cups all-purpose flour	1/2 teaspoon salt
4 teaspoons baking powder	1/4 cup butter, softened
	2/3 cup milk

Temperature: 425°F/218°C

Time: 45 minutes

Using chopping blade, chop onion on Speed 2 and remove from bowl. Insert slicing disk and slice potatoes, carrots and celery on Speed 7. Add all ingredients (except flour filling) to broth and boil for 20 minutes. To thicken, carefully remove 1/2 cup broth. Dissolve 2 tablespoons of flour into broth. Carefully pour thickening back into pan of vegetables and stir until thickened. Pour into a 9x13-inch greased pan.

Using chopping blade, combine crust ingredients, flour, baking powder, salt and butter. Set Speed Control to 4. Add the milk through the Food Chute and stop as soon as it is absorbed. Form the dough into a ball and roll onto a lightly floured surface. Cut into 2-inch biscuits and place on top of filling. Bake as directed.

Meatballs Yield: 4 Servings

1 pound lean stew meat	1/2 teaspoon dried thyme
1 slice bread	1 clove garlic
1 small onion	salt and pepper
1 egg	1/2 cup all purpose flour

Temperature: Medium

Time: 20-30 minutes

Using the chopping blade, add all ingredients, except flour, in the order listed, to bowl and chop on Speed 8 until meat is ground and ingredients are mixed together.

Shape into 2-inch meatballs and coat with flour. Add oil to skillet and cook meatballs as directed.

Fresh Salsa Yield: 5 Cups

- 4 cups Roma tomatoes, quartered and seeds removed
- 2 small jalapeno peppers, seeds removed
- 1 large onion, cut into 1-inch cubes
- 1 teaspoon cider vinegar
- 1 teaspoon salt
- 1/2 teaspoon black pepper
- 1/4 cup cilantro

Using the chopping blade and Food Chute add the onions, tomatoes then jalapeno peppers on Speed 6. Add the salt, pepper, vinegar and cilantro until chopped. Remove from bowl. Cover and refrigerate for 2 hours to enhance flavor.

Bruschetta Yield: 4 Cups

- 3 cups Roma tomatoes, quartered and seeds removed
- 1/2 medium onion, cut into 1-inch cubes
- 3 large cloves garlic, cut into thirds
- 16 fresh basil leaves
- 2 tablespoons olive oil
- 1 teaspoon red wine vinegar
- 1/2 teaspoon salt
- 1/4 teaspoon black pepper

Using the chopping blade, add the onions, garlic, olive oil, red wine vinegar, salt and pepper to the food processor bowl. Coarsely chop. Using the Food Chute, add tomatoes one at a time through the Food Chute. Add basil and coarsely chop. Remove from bowl and serve on warm grilled bread.

Grilled Bread for Bruschetta

- 1 loaf French Baguette or crusty Italian Bread, cut diagonally in 1/2-inch slices
- 2 teaspoons garlic salt
- 3/4 cup olive oil

Mix together olive oil and garlic salt. Brush both sides of the sliced bread with the oil mixture. Lightly brown both sides of the bread. Top warm bread with Bruschetta and serve.

Fried Chicken Salad Yield: 5 Servings

- 1 12- ounce box breaded chicken breast tenders
 - 1 package of iceberg lettuce salad mix
 - 1 medium cucumber with peeling
 - 1 medium green pepper, quartered lengthwise
 - 10 radishes
 - 1 bunch green onions with tops
 - 2 Roma tomatoes, halved
- Salad Dressing

Cook chicken breast tenders according to package instructions while preparing salad.

Empty salad mix into a large bowl. Place under Continuous Flow Side Chute and open shield.

Using slicing disc, place cucumber into large side of food chute and slice into salad bowl on Speed 8. Place two quarters of green pepper into large side of Food Chute at a time and slice into salad bowl. Place 5 radishes at a time into large side of Food Chute and slice into a salad bowl. Place bunch of green onions into small side of Food Chute and slice into salad bowl. Place two Roma tomatoes into the large side of the Food Chute and slice into salad bowl.

Top with warm chicken tenders and serve with your choice of salad dressing.

LIMITED ONE YEAR WARRANTY

Warranty Coverage: This product is warranted to be free from defects in materials or workmanship for a period of one (1) year from the original purchase date. This product warranty is extended only to the original consumer purchaser of the product and is not transferable. For a period of one (1) year from the date of original purchase of the product, our Repair Center will, at its option, either (1) repair the product or (2) replace the product with a reconditioned comparable model. These remedies are the purchaser's exclusive remedies under this warranty.

Warranty Service: To obtain warranty service, you must call our warranty service number at 1-800-233-9054 for return instructions on how to deliver the product, in either the original packaging or packaging affording an equal degree of protection to the Repair Center specified below. You must enclose a copy of your sales receipt or other proof of purchase to demonstrate eligibility for warranty coverage.

To return the appliance, ship to: To contact us, please write to, call, or email:

ATTN: Repair Center Consumer Relations Department
708 South Missouri Street PO Box 7366
Macon, MO 63552 USA Columbia MO 65205-7366 USA
1-800-233-9054
E-mail:
consumer_relations@toastmaster.com

What Is Not Covered: This warranty does not cover damage resulting from misuse, accident, commercial use, improper service or any other damage caused by anything other than defects in material or workmanship during ordinary consumer use. This warranty is invalid if the serial number has been altered or removed from the product. This warranty is valid only in the United States and Canada.

LIMITATION ON DAMAGES: THERE SHALL BE NO LIABILITY FOR ANY INCIDENTAL OR CONSEQUENTIAL DAMAGES FOR BREACH OF ANY EXPRESS OR IMPLIED WARRANTY OR CONDITION ON THIS PRODUCT.

DURATION OF IMPLIED WARRANTIES: EXCEPT TO THE EXTENT PROHIBITED BY APPLICABLE LAW, ALL IMPLIED WARRANTIES AND CONDITIONS, INCLUDING, WITHOUT LIMITATION, IMPLIED WARRANTIES AND CONDITIONS OF MERCHANTABILITY AND FITNESS FOR A PARTICULAR PURPOSE OR USE ON THIS PRODUCT ARE LIMITED IN DURATION TO THE DURATION OF THIS WARRANTY.

Some jurisdictions do not allow the exclusion or limitation of incidental or consequential damages, or allow limitations on how long an implied warranty lasts, so the above limitations or exclusions may not apply to you. This warranty gives you specific legal rights and you may have other rights under the laws of your jurisdiction.

For more information on our products, visit our website: www.maxim-toastmaster.com.

Made in China

04/07