



# Total Lighting Control



## Remote Control Smart Sweeper



### DESCRIPTION

The Remote Control Smart Sweeper is an intelligent component for simple lighting control. It provides 12 individual switch inputs and one Master input for a group of 12 relays. Each input will accept any 2- or 3-wire switch. The RSP12 converts any switch input to a momentary output to drive the corresponding relay(s). Each output can drive up to three relays in parallel.

The RSP12 also provides several advanced functions for basic lighting automation. Besides the Master ON/OFF function, it allows options for Time Delay and Flick Warning for individual overrides, as well as Automatic ON for all lights.

The RSP12 should be installed in a lighting automation panel or an accessory cabinet as detailed on the following page.

### FEATURES

- 12 individual relay outputs, with up to 3 relays wired in parallel per output.
- 12 individual switch inputs (one per relay) and one Master input.
- Inputs accept any 2- or 3-wire switch (dry contact).
- Master ON/OFF control for group of relays while retaining individual switch override.
- Additional control of subgroups by tying any combination of inputs together.
- "Occupied" contact to indicate normal working hours.
- Option to turn lights on automatically at start of normal working hours.
- Time delay in 15-minute increments up to 2 hours.
- Option to "flick warn" occupants 5 minutes before lights go off.

Before starting, read the installation instructions inside. If you have questions call GE Service at:

1-877-584-2685 (USA) or 1-800-661-6619 (Canada)

**FEATURE SUMMARY**

**24 Volt Power Inputs**

The RSP12 can be powered through the 24 volt rectified terminals on the Lighting Automation Panel motherboard\*

**Master Switch Input**

Master ON/OFF control for all connected relays

**12 Individual Relay Outputs**

Connect up to 3 relays wired in parallel per output

**12 Individual Switch Inputs**

Accept any 2- or 3-wire momentary or maintained dry-contact switch

**"Occupied" Contact**

Connected to a timeclock or BAS, indicates when a building is operating under normal working hours (closed contact) or after hours (open contact). Connection and scheduling determine when other functions will be enabled

**"Warn" Function**

Five minutes before the RSP12 is about to turn relays OFF at the end of normal working hours or at the end of a time delay, warns occupants by blinking the lights

**"Time Delay" Function**

After hours, any individual switch override will automatically be turned off if time delay is set from 15 minutes to 2 hours

**"Auto On" Function**

Can turn on all lights automatically at the start of normal working hours

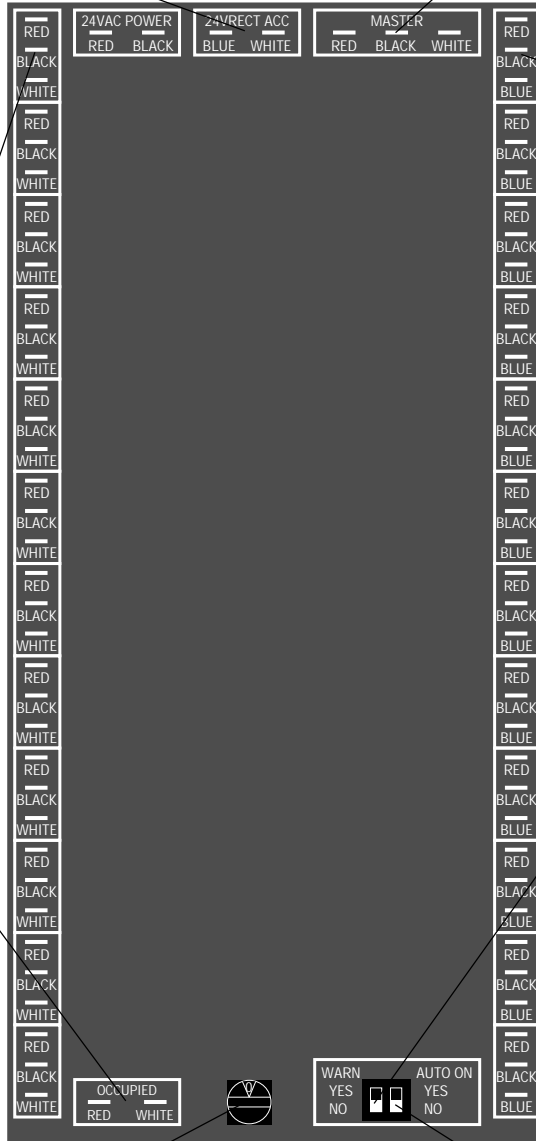

\*The 24 volt AC inputs can be used if connecting directly to a transformer.

**CAUTION:** The power supply must be OFF when inserting or removing components. These instructions assume the panel has a standard cover which exposes

both line-voltage and low-voltage sections. The line-voltage sections must be covered to avoid exposure to live high-voltage wiring.

## INSTALLATION

There are two recommended ways to install the RSP12 Remote Control Smart Sweeper — in a Lighting Automation Panel (LAP) or in an Accessory Cabinet near a Lighting Automation Panel

### Installation in a Lighting Automation Panel

A complete LAP assembly includes the following TLC components:

Tub	<b>RTUB12, -24 or -48</b>
Cover	<b>RCOV12xx, -24xxx or -48xxx</b>
Interior	<b>RINTER0012RC, -0024RC or -0048RC*</b>
Power Supply	<b>RPWRxxx</b>
Relays	<b>RR7P or RR9P</b>

\* RINTER0012RC and -0024RC accept one RSP12, RINTER0048RC accepts one or two

Details for assembling a complete Lighting Automation Panel are outlined separately in the RINTER installation instructions. Once the panel is assembled and relays are connected to the motherboard, the RSP12 may be installed.

### Basic Installation Steps

1. Mount the RSP12(s) on the panel accessory bracket.
2. Wire 24V rectified power from the panel motherboard to the blue and white power input tabs on the RSP12.
3. Wire red and black connections for each relay from the panel motherboard to relay outputs on the RSP12.
4. Wire any 2- or 3-wire switch to the individual switch inputs and/or the Master switch input on the RSP12 (not on the panel motherboard).
5. Select additional control functions.

### Installation in an Accessory Cabinet near the LAP

Accessory cabinets with covers include:

<b>RBS1</b>	Accepts one (1) RSP12
<b>RBS2</b>	Accepts two (2) RSP12s

Mount the RSP12 in the accessory cabinet and wire the same as above.

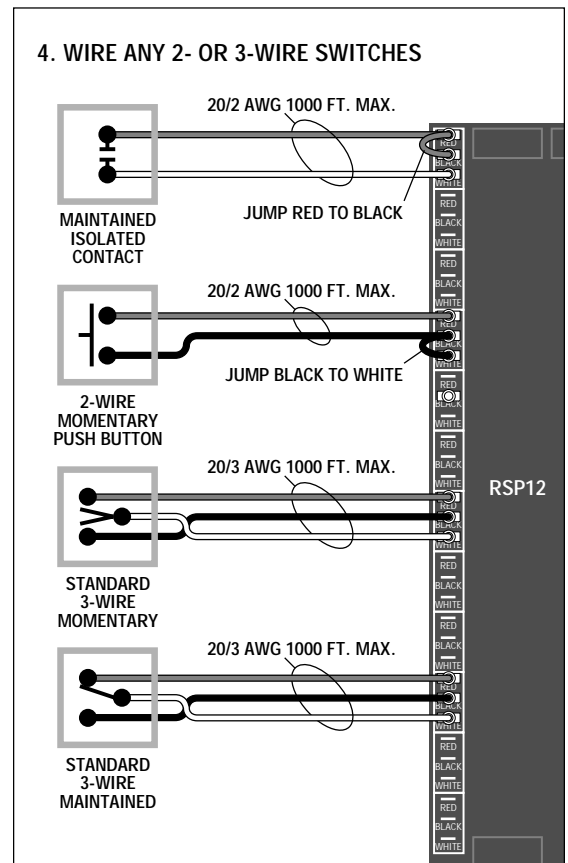
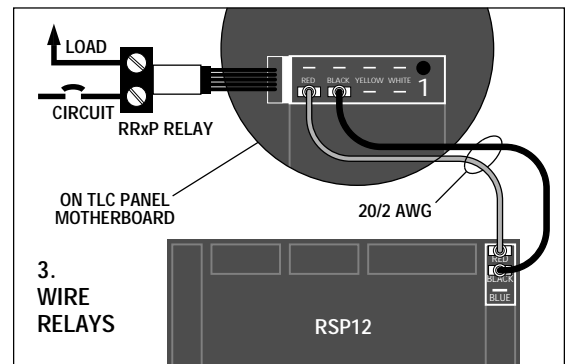
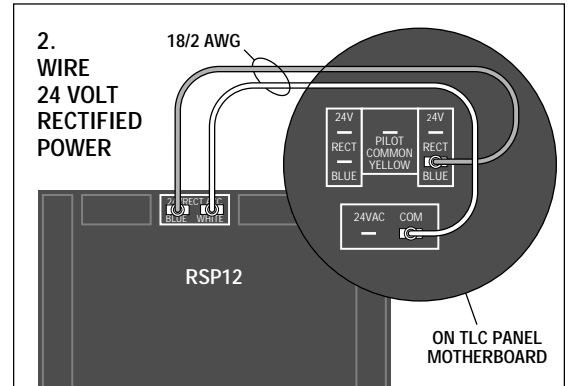
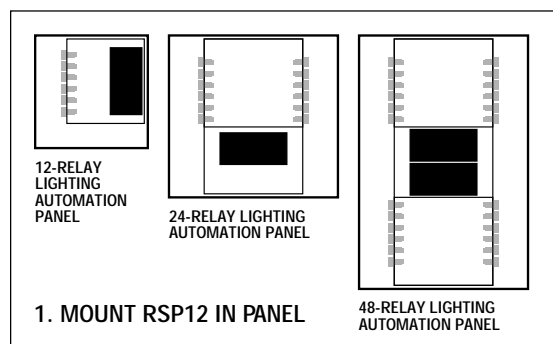

**ADDITIONAL CONTROL FUNCTIONS**

Four optional control functions are available at the bottom of the RSP12 board: Occupied, Time Delay, Warn and Auto Off. Set these functions for all relays connected to the RSP12 as a group, based on the needs at the site.

**Occupied**

The Occupied contact is available for connection with a timeclock or building automation system. It indicates when the building is operating under normal working hours (CLOSED contact) or after hours (OPEN contact). Properly connecting and scheduling the Occupied contact determines when other functions will be enabled.

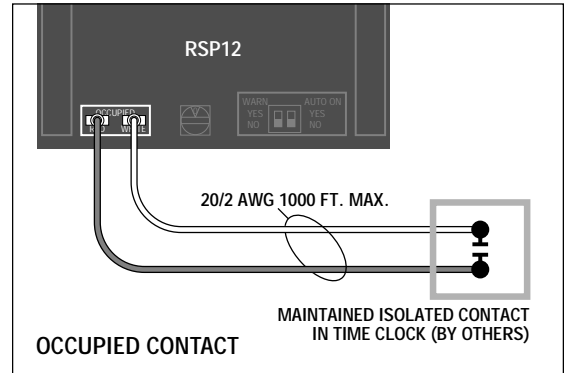

**Time Delay**

If the Time Delay function is set, when an occupant turns on a switch after hours (Occupied contact OPEN), the RSP12 will turn off the lights again after a predetermined amount of time. Each occupant override will have its own time delay.

Set the Time Delay dial as follows:

- 0 No time delay (no automatic off; lights must be manually turned off)
- 1-8 15-minute to 2-hour delay, in 15-minute increments
- 9 1-minute test

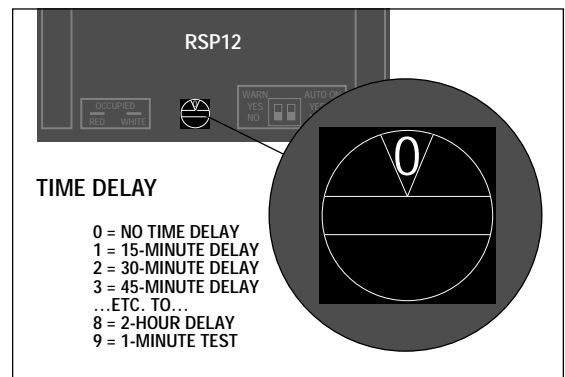

**Warn**

When the RSP12 turns relays OFF (at the end of normal working hours, or at the end of a time delay), it will optionally warn the occupants by blinking the lights five minutes before they go off.

Set the WARN switch to YES or NO as follows:

- yes Gives a 5-minute warning before lights turn off
- no Turns lights off without giving the warning

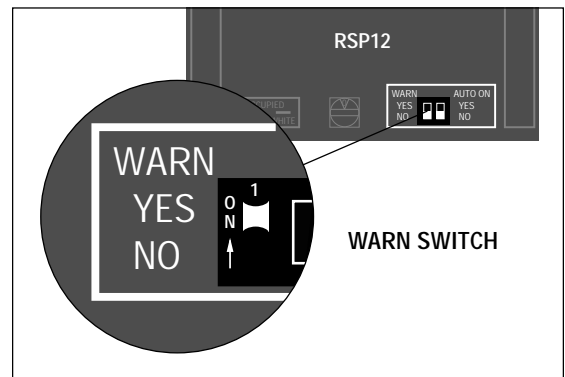

**Auto On**

When the Occupied contact closes at the start of normal working hours, the RSP12 can optionally turn all the relays ON automatically.

Set the AUTO ON switch to YES or NO as follows:

- yes Automatically turns all relays ON at start of normal working hours
- no Manual switch required to turn relays ON

