



OWNER'S MANUAL

DVD 7

HD720P & HD1080P OUTPUT DVD Player

NOTE: Before installing your new DVD 7 player, please read this manual carefully as it will inform you of the product specifications, proper installation and correct operating procedures for your unit. Also included in this manual are guidelines on how to service and care for your new Cary Audio Design product.

TABLE OF CONTENTS

Important Safety Instructions	2
Welcome	
Thank You	5
Product Features	5
Unpacking and Installation	6
Format Playback Compatibility	6
Specifications	
Video Specifications	7
Audio Specifications	7
Digital Audio Output Specifications	8
Making Connections	
Before Connecting	9
Connections to a TV	9
Optional Video Connections	9
Optional Audio Connections	10
Controls & Displays	
Front Panel	11
Rear Panel	13
The Remote Control	15
Getting Started	
Switching On	16
Using the On-Screen Displays	16
Changing Settings to Match your TV	16
Changing the Default Settings	
Choose the SETUP menu	18
Video Setup	18
Audio Setup	22
Disc Setup	24
Progressive Setup	27
AV Sync Setup	29
Playback	
Starting a Disc	30
Stopping Playback	30
Pausing Playback	31
Forward/Reverse Searching	31
Skipping to the Beginning of Chapters or Tracks	31
Playing Frame by Frame	32
Selecting the Still Image	32
Playing Bonus Groups	32
Service and Care	
Care and Cleaning	33
Factory Service	33
Non-Warranty Repairs	33
United States Limited Warranty	34

IMPORTANT SAFETY INSTRUCTIONS

WARNING: To reduce the risk of fire or electric shock, do not expose this appliance to rain or moisture. The lightning flash with arrowhead symbol within an equilateral triangle is intended to alert the user to the presence of un-insulated dangerous voltage within the product's enclosure that may be of sufficient magnitude to constitute a risk of electric shock to persons.



CAUTION: To reduce the risk of electric shock, do not remove the cover. There are no user serviceable parts inside. Please refer to qualified personnel for service.

ALERT: The exclamation point within an equilateral triangle is intended to alert the user of the presence of important operating and maintenance (servicing) instructions in the literature accompanying the component.

1. **READ ALL INSTRUCTIONS:** All the safety and operating instructions of your Cary Audio equipment should be read before power is applied to the equipment.
2. **RETAIN OWNER'S MANUAL:** These safety and operating instructions should be retained for future reference.
3. **HEED WARNING:** All warnings on the unit and in the operating instructions should be adhered to.
4. **FOLLOW INSTRUCTIONS:** All operating and use instructions should be followed.
5. **CLEANING:** Unplug the unit from the wall outlet before cleaning. The unit should be cleaned only as recommended by the manufacturer.
6. **ATTACHMENTS:** **Do not** use attachments not recommended by the unit manufacturer as they may cause hazards.
7. **WATER AND MOISTURE:** **Do not** use the unit near water - for example, near a bath tub, wash bowl, kitchen sink, or laundry tub; in a wet basement; or near a swimming pool.
8. **ACCESSORIES:** **Do not** place the unit on an unstable cart, stand, tripod, bracket, or table. The unit may fall, causing serious injury to a child, an adult, or damage to the unit. Mounting of the unit should follow the manufacturer's instructions and should use a mounting accessory recommended by the manufacturer.
9. **VENTILATION:** Slots and openings in the cabinet are provided for ventilation to ensure reliable operation of the unit and to protect it from overheating. These openings must not be blocked or covered. The top or bottom panel openings should never be blocked by placing the unit on a bed, sofa, rug, or other similar surface. The unit should not be installed in a built-in location such as a bookcase or rack unless proper ventilation is provided. There should be free space of at least 6 inches (16cm) above the unit and an opening behind the unit.
10. **GROUNDING OR POLARIZATION:** The unit may be equipped with a polarized alternating current line plug (a plug having one blade wider than the other). This plug will fit into the power outlet only one way. This is a safety feature. If you cannot insert the plug fully into the outlet, try reversing the plug. If the plug should fail to fit, contact a licensed electrician to replace your obsolete outlet. Do not defeat the safety purpose of the polarized plug.
11. **POWER SOURCES:** The unit should be operated only from the type of power source indicated on the marking label. If you are not sure of the type of power supplied to your home, consult your unit dealer or local power company.
12. **POWER CORD PROTECTION:** Power supply cords should be routed so that they are unlikely to be walked on or pinched by items placed on or against them. Pay close attention to cords where they enter a plug, or a convenience receptacle, and the point where they exit from the unit.
13. **OUTDOOR ANTENNA GROUNDING:** If an outside antenna or cable system is connected to the unit, be sure the antenna or cable system is grounded so as to provide protection against voltage surges and built-up static charges. Article 810 of the National Electrical Code, NSI/NFPA 70, provides information regarding proper grounding of the mast and supporting structure, grounding of the lead-in wire to an Antenna-discharge unit, size of grounding conductors, location of antenna-discharge unit, connection to grounding electrodes, and requirements for the grounding electrode.

IMPORTANT SAFETY INSTRUCTIONS

14. **LIGHTNING:** For added protection for the unit during a lightning storm, or when it is left unattended and unused for long periods of time, unplug it from the wall outlet and disconnect the antenna or cable system. This will prevent damage to the unit due to lightning and power line surges.
15. **POWER LINES:** An outside antenna system should not be located in the vicinity of overhead power lines or other electric light or power circuits, or where it can fall into such power lines or circuits. When installing an outside antenna system, take extreme care to keep from touching such power lines or circuits as contact with them might be fatal.
16. **OVERLOADING:** Do not overload wall outlets, extension cords, or integral convenience receptacles as this can result in a risk of fire or electric shock.
17. **OBJECT AND LIQUID ENTRY:** Never push objects of any kind into the unit through openings as they may touch dangerous voltage points or short-out parts that could result in a fire or electric shock. Never spill liquid of any kind on the unit.
18. **SERVICING:** Do not attempt to service the unit yourself as opening or removing covers may expose you to dangerous voltage or other hazards. Refer all servicing to qualified service personnel.
19. **REPLACEMENT PARTS:** When replacement parts are required, be sure the service technician has used replacement parts specified by the manufacturer or have the same characteristics as the original part. Unauthorized substitutions may result in fire, electric shock or other hazards.
20. **SAFETY CHECK:** Upon completion of any service or repairs to the unit, ask the service technician to perform safety checks to determine that the unit is in proper operating condition.
21. **WALL OR CEILING MOUNTING:** The unit should be mounted to a wall or ceiling only as recommended by the manufacturer.
22. **HEAT:** The unit should be situated away from heat sources such as radiators, heat registers, stoves, or other units (including amplifiers) that produce heat.
23. **IMPORTANT SAFETY NOTE:** Before connecting a new component such as the DVD 7 to your audio or home theater system it is always good practice to make certain that all components are turned off, and preferably unplugged from their AC power source. Many modern electronics products feature automatic turn-on circuits that may be activated during an installation, causing the potential for damage to electronic components and/or speakers. Such damage is not covered by product warranties and Cary Audio specifically disclaims responsibility for any such damage.

Power Cord: The removable power cord that is shipped with the player is specifically designed to be used with this product. Other AC cords may be used, so consult your dealer for advice on AC power cords and high quality wire in your system.



AC Fuse: The fuse is located inside the chassis and is not user serviceable. If power does not come on, contact your authorized service representative.

Wiring: Cables that run inside of walls should have the appropriate markings to indicate compliance with, and listing by the UL, CSA or other standards required by the UL, CSA, NEC or your local building code. Questions about cables inside of walls should be referred to a qualified custom installer, or a licensed electrician or low-voltage contractor.

Do Not Open the Cabinet: There are no user serviceable components inside this product. Opening the cabinet may present a shock hazard, and any modification to the product will void your warranty. If water or any metal object, such as a paper clip, coin, or staple accidentally falls inside the unit, disconnect it from the AC power source immediately and contact Cary Audio for further instructions.

24. **RECORDING COPYRIGHT:** Recording of copyrighted material for other than personal use is illegal without permission of the copyright holder.
25. **NOTE TO CATV SYSTEM INSTALLER:** This reminder is provided to call the CATV system installer's attention to article 820-40 of the NEC, ANSI/NFPA 70, which provides guidelines for proper grounding and, in particular, specifies that the cable ground shall be connected to the grounding system of the building, as close to the point of cable entry as practical.

IMPORTANT SAFETY INSTRUCTIONS

26. FCC INFORMATION FOR USER:

CAUTION: ANY changes or modifications not expressly approved by the party responsible for compliance could void the user's authority to operate the equipment.



NOTE: This equipment has been tested and found to comply with the limits for a Class B digital device pursuant to Part 15 of the FCC Rules.

These limits are designed to provide reasonable protection against harmful interference in a residential installation. This equipment generates and can radiate radio frequency energy and, if not installed and used in accordance with the instructions, may cause harmful interference to radio communications. However, there is no guarantee that interference will not occur in a particular installation. If this equipment does cause harmful interference to radio or television reception, which can be determined by turning the equipment off and on, the user is encouraged to try to correct the interference by one or more of the following measures:

- Reorient or relocate the receiving antenna.
- Increase the separation between the equipment and receiver.

Connect the equipment into an outlet on a circuit different from where the receiver is connected.

27. OUTDOOR ANTENNA INSTALLATION/SAFE ANTENNA AND CABLE CONNECTION:

If an outside antenna or cable system is connected to the equipment, be sure the antenna or cable system is grounded so as to provide protection against built up static charges and voltage surges, Section 810 of the national Electrical Code, ANSI/NFP A70 (in Canada, part 1 of the Canadian Electrical Code) provides information with respect to proper grounding of the mast and supporting structure, grounding of the lead-in wire to an antenna discharge unit, size of grounding conductors, location of antenna discharge unit, connection to grounding electrodes and requirements for the grounding electrode.

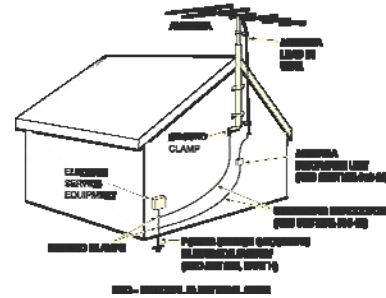

Keep Antenna Clear of High Voltage Power Lines or Circuits

An outside antenna system should be located well away from power lines, electric light or power circuits and where it will never come into contact with these power sources if it should happen to fall. When installing an outside antenna, extreme care should be taken to avoid touching power lines, circuits or other power sources as this could be fatal. Because of the hazards involved, antenna installation should be left to a professional.

WELCOME

THANK YOU

Dear Customer:

We would like to thank you for your decision to buy a Cary Cinema DVD 7 player. The DVD 7 is one of the best DVD players available on the market today and we expect that you will enjoy your cinematic home experience for years to come. The DVD 7 player is a continuance and elevation of the DVD 6 player which met and exceeded customer expectations time and time again. The DVD 7's craftsmanship, forward thinking design, and flexibility make it a desirable component for all video lovers, integrating well with existing home theater setups and new designs alike.

Thank you for your support and enjoy your movies!

The Cary Audio Team

PRODUCT FEATURES

The DVD 7, our third generation DVD player, is assembled with the best available components. It is an innovative design of the highest quality. The DVD 7 player provides video outputs from 480i to as high as 1080p with HDMI, RGB + HV or Component video outputs. This truly unique feature is compatible with either HD or ED video displays. The audio soundtrack playback quality matches the vibrancy and vividness of the video output from the *ALWAYS ACTIVE* triple video processor section.

The DVD 7 offers:

- Video outputs from 480i to as high as 1080p with HDMI, RGB + HV or Component video outputs
- Rugged steel chassis
- Industrial grade DVD CD ROM drive mechanism
- Fiberglass PCBs
- 1% precision parts
- Fully regulated power supplies
- Steel tunnel shielded drive mechanism
- Discrete commands for RS 232 and infra red codes for remote control

The DVD 7 player has 3 completely separate *ALWAYS ACTIVE* video output sections. You can run the linked HDMI or RGB video outputs at a display setting of 480p/576p to as high as 1080p at the same time and same setting. Simultaneously, you can use the Component video outputs at an independent setting of 480i, 480p, 720p, 1080i or 1080p. The S-Video or the composite video outputs can run 480i at the same time. If they are all the same aspect ratio, this player can be the video source for 3 to 6 displays at the same time.

The DVD 7 is also unique because it offers audio playback quality beyond compare. The audio section of the DVD 7 is derived from the CD 303/300, which was named the "2005 Product of the Year" by Electronic House magazine. The DVD 7's sound quality rivals audiophile CD players at any price point.

WELCOME

UNPACKING AND INSTALLATION

This section describes the unpacking and installation procedures for your new component.

Unpacking

All Cary Audio Design shipping cartons have been specially designed to protect their contents and special care has been taken to prevent damage under normal shipping conditions. Mishandling should be evident upon inspection of the shipping container. If shipping damage is found after visual inspection, take care not to destroy the evidence. If necessary, document the damage with photographs and contact the transport carrier immediately.

Carefully remove your new component from its packing carton and examine it closely for signs of shipping damage. We strongly recommend saving all original packing cartons to protect your component from damage should you wish to store it or ship it at a later date.

In the Box

When unpacking your DVD 7 player, make sure the following accessories are included. You should find the following items:

- Power Cable
- Remote Control (batteries already installed)
- Owner's Manual
- Warranty Card

Warranty Card

If you are the original purchaser of this unit and you purchased it in the United States, you should fill out the enclosed warranty registration card and return it to Cary Audio Design within 15 days of your purchase. Cary Audio Design also suggests that you keep your original packing cartons in case you ever need to ship the unit when moving to a new home. Warranty restrictions apply. Consult the warranty section of this manual for details. Please be certain to keep a copy of the original sales receipt from your Authorized Cary Audio Design dealer to validate the warranty if ever needed.

FORMAT PLAYBACK COMPATIBILITY

The Cinema DVD 7 can play CD, Video CD, DVD Video, DVD-R, DVD+RW and CD-RW disks.



It incorporates technology from Dolby Laboratories®, Digital Theater Systems®, Faroudja®, a Division of Genesis Microchip and the High Definition Multimedia Interface.

**All trademarks belong to their original owners.*

SPECIFICATIONS

Operating the DVD 7 player is a simple procedure. Each unit is designed for long term stability in virtually any home operating situation. However, if the unit is operated outside the parameters outlined in this owner's manual, damage may result. Please read this manual carefully before putting your new DVD 7 player into operation.

The following section describes the DVD 7 players' basic specifications. The specifications are subject to change without notice or obligation.

VIDEO SPECIFICATIONS

Playback System	DVD Video / Video CD / CD / DVD-RW / DVD+RW / CD-RW
Video DAC chips HDMI/RGB/CV <i>(3 Video chip sets)</i>	Dual Faroudja Video Format Converter/HDMI Dual 12 bit/216 MHz/RGB 12 bit/108 mHz Component Video (CV)
Video S/N Ratio	78.5 dB
Video Signal Resolution	540 TV Lines (DVD)
Signal Format System	PAL / NTSC
Composite Video Output	1.0 volt peak to peak (75 Ohm), Sync Negative
S-Video	Luminance Signal: 1 volt peak to peak (75 Ohm load) Color Signal: 0.286 volt peak to peak (75 Ohm load)
Interlaced and Progressive Component Video Output	Y Output Level: 1.0 volt peak to peak (75 Ohm load) Pb Output Level: 0.7 volt peak to peak (75 Ohm load) Pr Output Level: 0.7 volt peak to peak (75 Ohm load)
Progressive Component Output Settings	480p/576p, 720p, 1080i, 1080p
Interlaced Video Outputs	480i - Component, S-video and Composite Video
HDMI/RGB Output Settings	480p/576p, 720p, 1080i, 1080p, 600x800, 1024x768, 1280x1024, 1366x768

AUDIO SPECIFICATIONS

Master Clock Jitter	Below measurable levels
Digital/Analog Converters	Burr Brown PCM 1792u
Analog Filter	Third Order Bessel
Analog Outputs	RCA, XLR stereo

SPECIFICATIONS

Frequency Range	2-22 kHz Fs = 48 kHz 2-44 kHz Fs = 96 kHz
Amplifier Linearity	0.1dB (20 Hz – 20 kHz)
Phase Linearity	3.0 degrees (20 Hz – 20 kHz)
Dynamic Range	120 dB (1 kHz)
Signal-to-Noise Ratio	120 dB (1 kHz)
Channel Separation	108 dB (1 kHz)
Total Harmonic Distortion	0.0008% (1 kHz)
Audio Output Level	RCA - 2.2 V rms fixed, XLR - 4.4 volts fixed RCA - 3.0 V rms variable, XLR - 6.0 volts variable

DIGITAL AUDIO OUTPUT SPECIFICATIONS

Coaxial Digital	Dolby Digital / DTS / LPCM 200 mV rms @ 75 Ohms
Optical Digital (Toslink)	Dolby Digital / DTS / LPCM
AC Power	110 - 120 Volts AC or 220-240 Volts AC, 50 - 60 Hz
Power Consumption	32 watts - Operation 5 watts - Standby
Video Output Modes	Component Video: 480i, 480/576p, 720p, 1080i, 1080p HDMI/RGB+HV: 480p, 720p, 1080i, 1080p, 600x800, 1024x768, 1280x1024, 1366x768 S-Video, Composite Video: 480i
Chassis	Black enamel steel chassis, silver anodized aluminum front panel
Weight	35 lbs.
Dimensions	18" W x 4" H x 14"

MAKING CONNECTIONS

To accommodate a wide range of home entertainment systems, this player features numerous types of connections for both audio and video. Please continue reading this section for help determining the best possible connections for your system.

BEFORE CONNECTING

Read the instruction manuals of any component that you plan to connect to the DVD 7 player. For all components, turn the power off and unplug them from the wall outlet before making any connections.

Connect the DVD 7 player to the TV directly. If you connect the DVD 7 player to a VCR, TV/VCR combination, or video selector, the playback picture may be distorted as DVD Video images are copy protected.

Please note that video connections to a TV or monitor are necessary because some discs require on-screen menu interaction before they can be played.

CONNECTIONS TO A TV

Using the Audio/Video Connection Cable

Using the audio/video cable (Three RCA cables with left and right audio plus one video cable, not included), make audio connections from the ANALOG OUTPUT L and R jacks to the corresponding audio input jacks on the TV. In the same manner, make the composite video connection from the VIDEO OUTPUT video jack to the corresponding video input jack on the TV. Be sure to set Audio Setup > Speaker Setup Select to "Movie Stereo" using the on-screen setup menu.

Note: Be sure to match the colors of the plugs on the cable with the corresponding jacks on the DVD 7 player and the TV: yellow for composite video, red for R (right) audio and white for L (left) audio.

OPTIONAL VIDEO CONNECTIONS

Visible improvement in video quality, when compared to composite video connections, can be achieved by making either S-Video or component video connections to a TV or monitor compatible with these connections. When either S-Video or component video connections are made, it is not necessary to make composite video connections using the yellow cord of the audio-video cable.

Making Component Video Connections (Interlaced)

If the TV or monitor has interlaced component video inputs, making this type of video connection will produce the ideal picture quality for the presentation of DVD video. Using a component video cable (not included), connect the interlaced VIDEO OUTPUT COMPONENT jacks to the corresponding component video input jacks on the TV. Actual labels for component video inputs may vary depending on the TV manufacturer. (E.g. Y, R-Y, B-Y or Y, CB, CR) Component video cables are typically designated with red (R), blue (B), and green (G) color bands to show how to correctly connect them to the player and the TV.

MAKING CONNECTIONS

In some TVs or monitors, the colors levels of the playback picture may be reduced slightly or the tint may change. In such a case, adjust the TV or monitor for optimum performance. Be sure to set Audio Setup > Speaker Setup Select to "Movie Stereo" using the on-screen menu.

Making Component Video Connections (Progressive)

Some TVs or video monitors are equipped with Progressive Scan component video inputs (with BNC Connectors) that are capable of reproducing a progressively scanned video signal. Connecting to these inputs allows you to view the highest quality picture with less flicker. Please ensure that the Red, Blue, and Green designated cables are correctly connected by matching colors at the DVD player and at the TV connections. Component video connections offer the best video playback for many TVs.

Making S-Video Connections

If the TV or monitor has an S-video input, making this type of video connection will produce improved picture quality over a composite video connection. Using an S-video cable, connect the VIDEO OUTPUT S-Video jack to the corresponding S-video input jack on the TV. Be sure to set Audio Setup Speaker Setup Select to "Movie Stereo" using the on-screen menu.

OPTIONAL AUDIO CONNECTIONS

The DVD 7 player provides numerous ways to take full advantage of the digital multi-channel sound recorded on DVD media.

When listening to CD Audio

For full enjoyment of CD Audio media, it is recommended to make connections from the Left and Right ANALOG OUTPUT jacks to the Left and Right DVD or CD player input connections on your preamplifier, AV Receiver or surround processor.

Making Stereo Audio Connections

By making connections to a stereo system, you can improve the quality of the sound of cinematic presentations as well as make effective use of the DVD player's ability to playback CDs. Using an audio cable (sold separately), make audio connections from the ANALOG OUTPUT L and R jacks to the corresponding jacks on the stereo component.

Note: Be sure to match the colors of the plugs on the cable with the corresponding jacks on the DVD player and the stereo component: red for Right audio and white for Left audio. Do not make connections to the PHONO input jacks on the stereo component, as it is not compatible with regular line level inputs.

Digital Connections

Make digital connections from the DVD player to an AV component that features digital input capability or one or more multi-channel audio decoders to realize the full cinematic experience made possible by the DVD format. This DVD player features one set each of an optical and a coaxial digital audio output jack and can output Dolby Digital, DTS and PCM bit streams. Make connections from the DIGITAL OUTPUT OPTICAL (Toslink) jacks to the digital optical input jack on the AV component using an optical fiber cable (sold separately). Make connections from the DIGITAL OUTPUT COAXIAL jacks to the digital coaxial input jack on the AV component using a coaxial cable (sold separately). It is not necessary to make more than one type of digital connection to a single component, when you are making connections to an amp or receiver that has internal Dolby Digital or DTS decoding capabilities.

CONTROLS AND DISPLAYS

FRONT PANEL

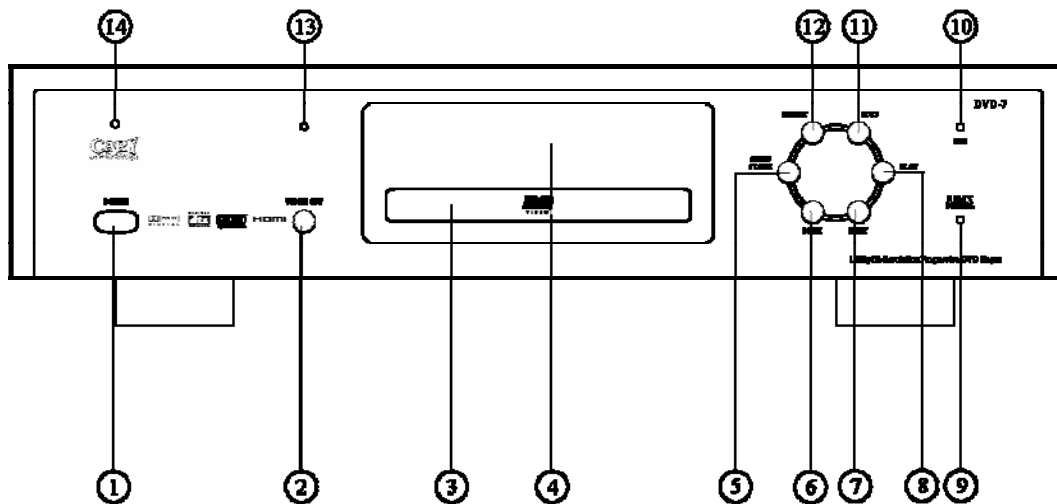

1. POWER

- Press once to turn the power ON.
- Press again to turn the power OFF. The DVD 7 will enter STANDBY and the blue POWER LED will light.

2. VIDEO OFF

- Press once to turn the video OFF (for best CD Audio playback) and the blue LED will light.
- Press again to turn the video ON for DVD video playback.

3. DISC LOADER TRAY

- Load discs here.

4. ALPHANUMERIC Display

- A multi-character display providing information on the operation of the DVD 7 player.

5. DISC LOADER TRAY OPEN/CLOSE

- Press this button to open and close the disc loader tray.

6. AUTOMATIC SEARCH, REVERSE

- Press this button to return to the beginning of the present track.
- Press again to return to a previous track.

7. AUTOMATIC SEARCH, FORWARD

- Press this button to move forward to the beginning of the next track.
- Press again to move ahead to other tracks.

8. PLAY

- Press this button to start playback.

9. DOLBY DIGITAL Indicator

- This LED lights when the DOLBY DIGITAL decoding function is ON.

CONTROLS AND DISPLAYS

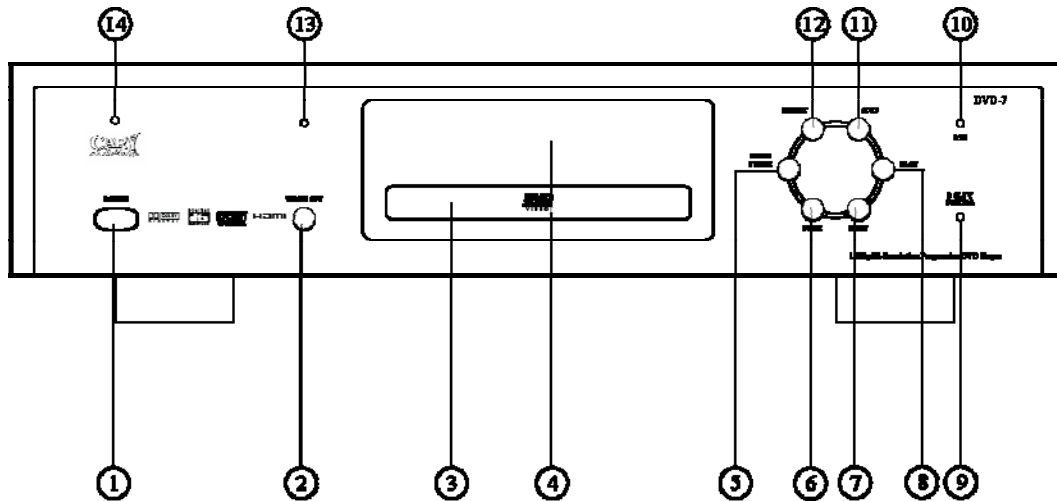

10. DTS Indicator

- This LED lights when the DTS decoding function is ON.

11. STOP

- Press this button to stop playback.

12. REPEAT

- Press this button to play a single track or all tracks repeatedly, as shown in the alpha numeric display window.

13. VIDEO OFF Indicator

- This LED lights when the video outputs are set to OFF mode.

14. POWER Indicator

- This LED lights when the player is turned OFF.

CONTROLS AND DISPLAYS

REAR PANEL

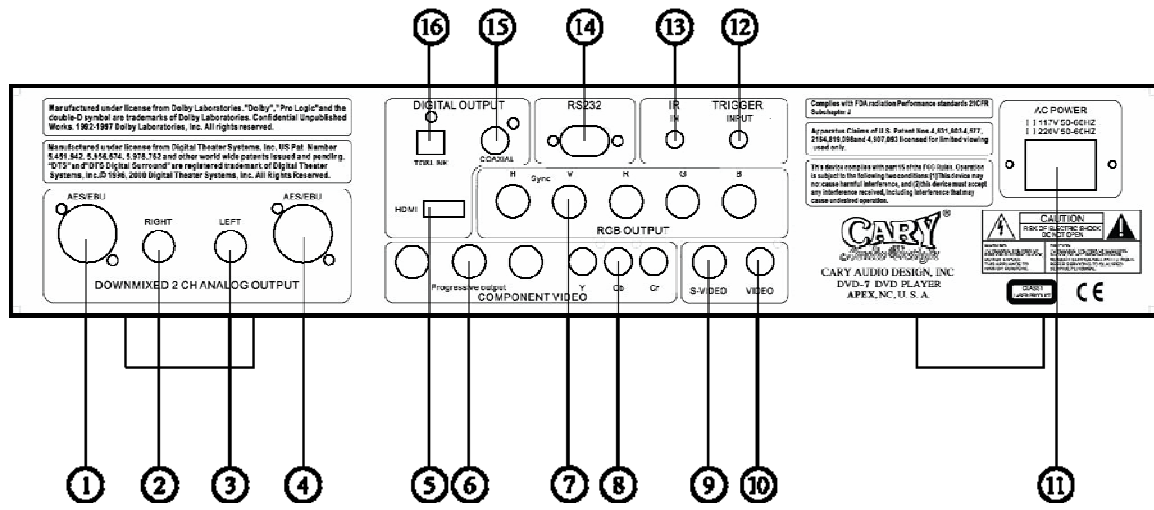

1. **RIGHT CHANNEL ANALOG OUTPUT JACK (AES/EBU Balanced)**
 - Use this jack for connection to the amplifier's right channel balanced input jack.
2. **RIGHT CHANNEL ANALOG OUTPUT JACK (RCA Unbalanced)**
 - Use this jack for connection to the amplifier's RCA right channel unbalanced input jack.
3. **LEFT CHANNEL ANALOG OUTPUT JACK (RCA Unbalanced)**
 - Use this jack for connection to the amplifier's RCA left channel unbalanced input jack.
4. **LEFT CHANNEL ANALOG OUTPUT JACK (AES/EBU Balanced)**
 - Use this jack for connection to the amplifier's left channel balanced input jack.
5. **HDMI OUTPUT JACK**
 - Use this jack to connect to a TV, Monitor or AV receiver that has an HDMI input.
6. **480p-1080p PROGRESSIVE COMPONENT VIDEO OUTPUT JACKS**
 - Use these jacks to connect to a TV, Monitor or AV receiver that has progressive component video capability and inputs. The connectors used for this are BNC connections. BNC > RCA adapters are available if your display uses RCA connections.
7. **RGB+HV SYNC VIDEO OUTPUT JACKS**
 - Use these jacks to connect to a TV, Monitor or AV receiver that has RGB+HV SYNC video inputs. These are BNC connections. Consult your dealer about matching cables.
8. **480i INTERLACED COMPONENT VIDEO OUTPUT JACKS**
 - Use these jacks to connect to a TV, Monitor or AV receiver that has interlaced component video capability and inputs. The outputs for this section use RCA connections, with 75 Ohm cable (not included).
9. **S-VIDEO OUTPUT JACK**
 - Use this jack to connect to a TV, Monitor or AV receiver that has an S-VIDEO input. An S-video cable is needed to use this connection (not included).

CONTROLS AND DISPLAYS

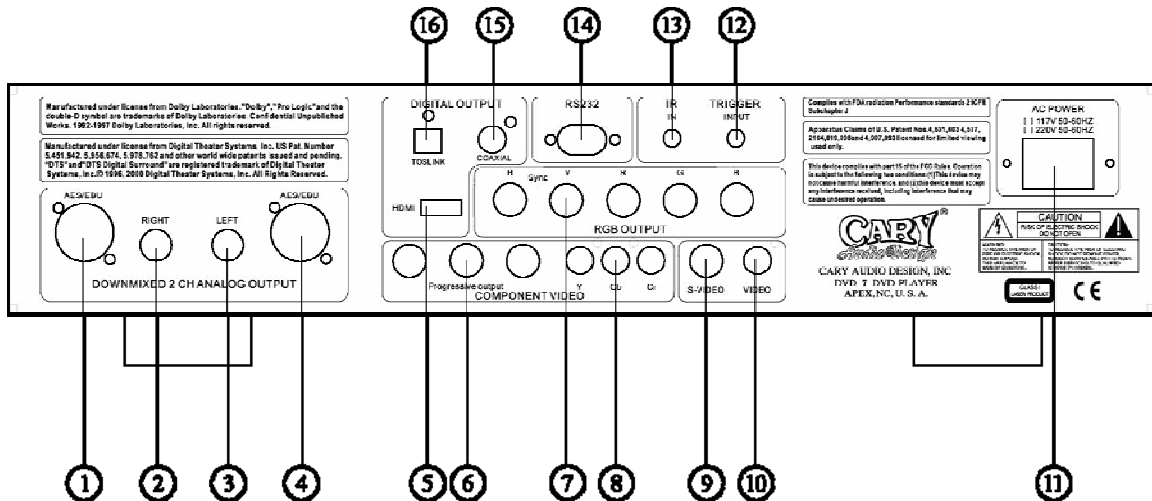

10. COMPOSITE VIDEO OUTPUT JACK

- Use this jack to connect to a TV, Monitor or AV receiver that has a composite VIDEO input. Composite video connections use an RCA connector with 75 ohm cable for best results (not included).

11. POWER INPUT (AC IN)

- Connect to an AC power supply using the included power supply cord.

12. DC TRIGGER INPUT TERMINALS

- Connect a device that can be triggered by DC + 12V trigger signal.

13. IR INPUT JACK

- Use this jack to connect external IR sensors.

14. RS 232 PORT

- The RS-232 port is used in conjunction with an external home automation remote controller to control the operation of the DVD 7. (This is for custom installation use. Consult your dealer for more information.)

15. DIGITAL OUTPUT JACK (COAXIAL)

- 44.1 kHz - 48 kHz digital data is output from this RCA coaxial digital output connection.

16. DIGITAL OUTPUT JACK (TOSLINK)

- 44.1 kHz - 48 kHz digital data is output from this optical digital output connection.

NOTE: Analog Audio Output: Pin assignments of the XLR-type male analog outputs:

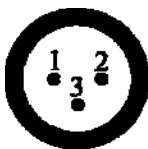

- Pin 1: Signal ground
- Pin 2: Signal + (non-inverting)
- Pin 3: Signal - (inverting)
- Connector ground lug: chassis ground

Refer to your associated amplifier's operating manual to verify that the XLR pin assignments of its input connectors correspond to the XLR pin assignments for the analog XLR outputs of the DVD 7. If the pin assignments are different, wire the XLR cable so that the appropriate XLR output pin connects to the equivalent XLR input pin. We have wired this connector to the AES/EBU (Audio Engineering Society/European Broadcast Union) standard.

CONTROLS AND DISPLAYS

REMOTE CONTROL

This section explains how best to use the remote control to set up and operate the DVD player.

1. **OPEN/CLOSE:** Use to open or close the tray.
2. **NUMBER BUTTONS**
3. **GO TO:** Use to skip to specified title, chapter or time. Press GO TO, then the track or Chapter number, and then press PLAY.
4. **ANGLE:** Use to change the camera angle during DVD multi-angle scene playback.
5. **SETUP:** Use to show and hide the set up menu.
6. **UP/DOWN/LEFT/RIGHT & ENTER:** Use to navigate on-screen displays and menus. Press ENTER to select an option or execute a command.
7. **OSD DISPLAY:** Use to display information about the disc playing.
8. **STOP:** Use to stop the disc.
9. **PAUSE:** Use to pause playback; press again to resume playback.
10. **POWER:** Use to switch the player ON or into standby.
11. **SUBTITLE:** Use to select a subtitle display.
12. **AUDIO:** Use to select the audio channel or language.
13. **MENU:** Use to display the top menu of a DVD disc.
14. **TITLE:** Use to display a DVD disc menu or the Disc Navigator of a DVD-RW, CD, Video CD or Mp3 disc.
15. **PLAY:** Use to start or resume playback.
16. **PREVIOUS/NEXT:** Use to jump to the start of the previous/next chapter/track.
17. **REVERSE/FORWARD:** Use to reverse/forward slow motion playback, frame reverse/advance and reverse/forward scanning.
18. **ZOOM +/- BUTTONS:** Use to enlarge and reduce the screen image.
19. **VOLUME:** Use to adjust the level when the variable volume setting is activated in the SET UP menu.

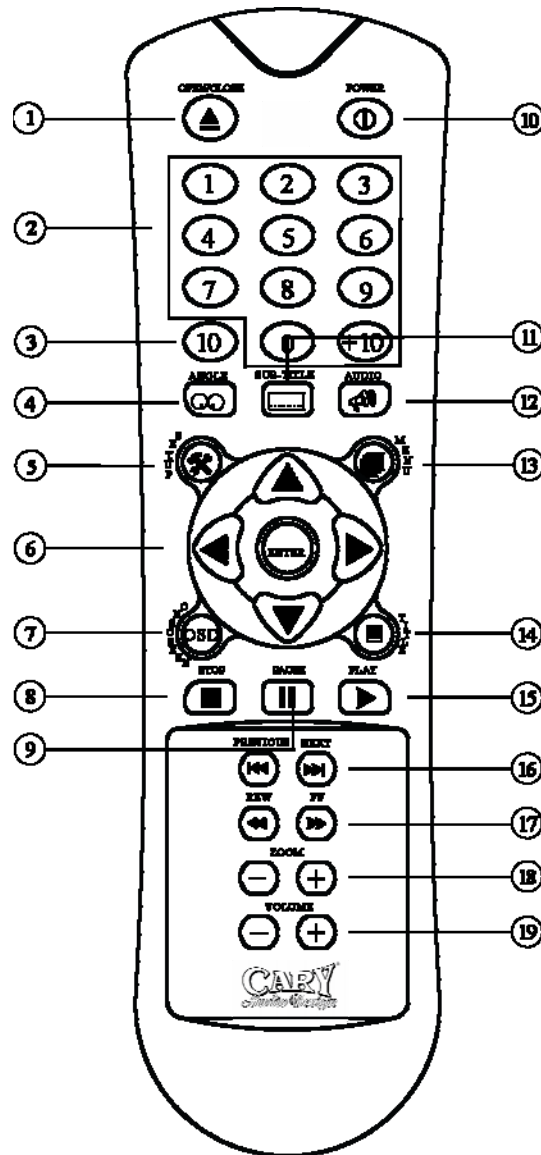

GETTING STARTED

SWITCHING ON

After making sure that everything is connected properly and that the player is plugged in, press the POWER button on the front panel to turn the player on. Turn on your TV and make sure that it is set to the correct input for the DVD 7.

The front panel POWER button switches the player ON and OFF. When the player is OFF, it can only be turned back on using the front panel button or the ON button on the remote control. When the player is ON, you can put it into STANDBY using the POWER button on the remote control handset or the front panel button.

USING THE ON-SCREEN DISPLAYS

For ease of use, this player makes extensive use of graphical on-screen displays (OSDs). Familiarize yourself with the way these work as you'll need to use them when setting up the player, or when using some of the playback features and making more advanced settings for audio and video.

The screens are navigated in a similar way, using the cursor buttons to change the highlighted item and pressing ENTER to select it.

CHANGING SETTINGS TO MATCH YOUR TV

Using the SETUP menu, you can determine the settings that best fit your TV and system. Press the **SETUP** button. Use the **UP ▲**, **DOWN ▼**, **LEFT ◀**, and **RIGHT ▶** cursor buttons to select the desired setting.

1. Select **VIDEO SETUP**.

2. Select **TV DISPLAY**.

If you have a widescreen or 16x9 TV, select the Wide setting. Widescreen DVD software is shown using the full screen area. When playing software recorded in conventional (FS or full screen, 4x3) format, the settings on your TV will determine how the material is presented. See the manual that came with your TV for details on what options are available.

If you have a conventional or 4x3 TV, select either **NORMAL (Letter Box)** or **NORMAL (Pan & Scan)**. In Letter Box mode, widescreen software is shown with black bars at the top and bottom of the screen. Pan and Scan chops the sides off of widescreen material to make it fit the **NORMAL** screen (so even though the image looks larger on the screen, you're actually seeing less of the picture). Press **ENTER** to save the setting.

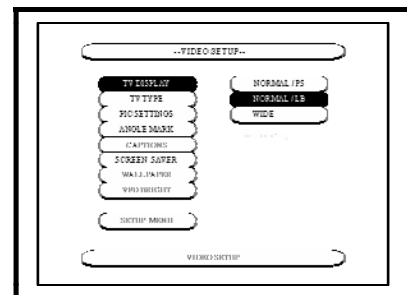
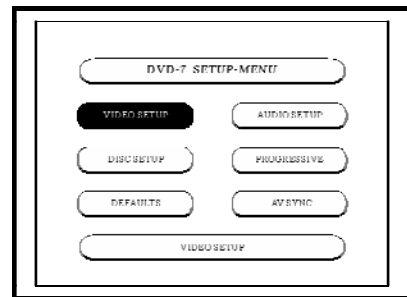

GETTING STARTED

3. Select **"TV TYPE"**

The default setting of this player is MULTI and unless you notice that the picture is distorted when playing some discs, you should leave it set to MULTI. If you experience picture distortion with some discs, set the TV system to match your country or region's system. Unfortunately, this may restrict the kinds of disc you can watch.

Once you have made your changes, the settings are retained until they are changed again, even when the power is turned OFF.

Note: For some menus, the initial values can be changed during playback.

CHANGING THE DEFAULT SETTINGS

CHOOSE THE SETUP MENU

The SETUP menu allows you to make alterations to the video, audio, disc, progressive and AV Sync settings. Use the **UP ▲**, **DOWN ▼**, **LEFT ◀**, and **RIGHT ▶** cursor buttons to select the desired setting. Press **ENTER** to save changes in settings. Press the **SETUP** button and the following options appear:

1. VIDEO SETUP

Use this to set the DVD 7 screen mode.
(TV aspect and TV type)

2. AUDIO SETUP

Use this to set the DVD 7 audio output mode.
(Digital and LPCM output settings)

3. DISC SETUP

Use this to set the language to be used when playing the disc. If the set language is not offered on that disc, the discs default language is set.

4. PROGRESSIVE SETUP

Use this to set the Progressive Video Output mode, HDMI and RGBs Video Output mode.

5. DEFAULTS

Use this to reset the factory defaults settings.

6. AV SYNC SETUP

Use this to set the Audio & Video so they are synchronized in timing for the video and the audio signals. Some disks have incorrect timing and the video and the audio signals are slightly out of "synch" which is visible from careful viewing.

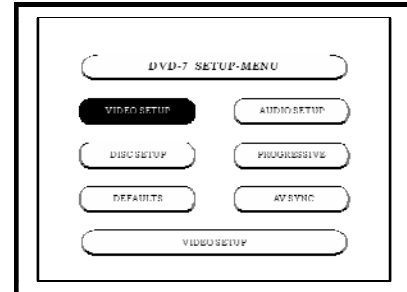

VIDEO SETUP

Choose Video Setup and press **ENTER**. Use the **UP ▲**, **DOWN ▼**, **LEFT ◀**, and **RIGHT ▶** cursor buttons to navigate the options within Video Setup. When making changes, navigate to the desired selection and press **ENTER**. Press the **LEFT ◀** arrow to return to the list of options within Video Setup. To exit Video Setup, use the **DOWN ▼** arrow to navigate to the bottom of the list making SETUP menu visible. Choose the SETUP button to return to the main SETUP menu.

TV DISPLAY

Use this to set the shape of your TV's screen.

Normal / PS (for 4/3 shape screens)

Select this to play wide DVDs in the pan and scan mode.
(with sides of the picture cut off)

Discs for which pan and scan is not specified are played in the Letter Box mode.

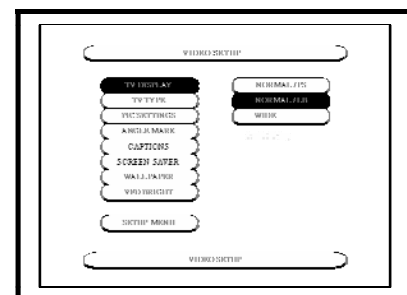

CHANGING THE DEFAULT SETTINGS

Normal/LB (Factory default) (for 4/3 shape screens)
Select this to play wide DVDs in the Letter Box mode.
(with black strips at the top and bottom)

Wide (for 16x9 shape screens)
Select this to play wide DVDs in the full-screen mode.

TV TYPE

TV Type allows you to set your TV's video format.

NTSC & PAL Video Standards

There are differences in discs for the NTSC and the PAL TV systems. The MPEG video on a DVD disk is stored in a digital format. It is formatted for one of two mutually incompatible television systems, either as NTSC or as PAL/SECAM. Therefore, there are two kinds of DVDs available, either NTSC DVDs or PAL DVDs. Some players only play NTSC discs; others play PAL and NTSC discs.

North America, Japan, Korea, the Philippines and parts of South America use the NTSC format for video. The rest of the world mostly uses the PAL video format. There are two ways to watch both PAL and NTSC DVDs. You can either view your DVDs on a multi-system TV display or video projector or you can choose an NTSC/PAL or PAL/NTSC capable DVD Player. The Cinema DVD 7 is capable of playing either PAL or NTSC format DVD disks. If you are a movie collector who loves foreign films, the DVD 7 will play your entire collection.

NTSC (Factory default)

Select this when your TV's video format is NTSC. If NTSC is selected, output format is fixed to NTSC.

PAL

Select this when your TV's video format is PAL. If PAL is selected, output format is fixed to PAL.

MULTI

Select this when your TV is compatible with both the NTSC and PAL formats. NTSC signals are output from the video output jacks when discs recorded in NTSC format are played, and PAL signals are output from the video output jacks when discs recorded in PAL format are played. Many plasma and LCD based video displays are compatible with this setting.

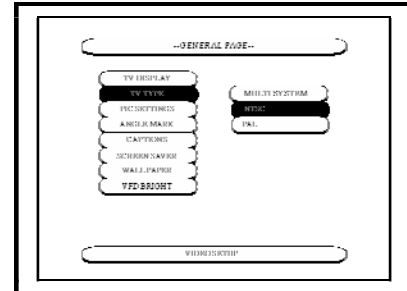

CHANGING THE DEFAULT SETTINGS

PIC SETTINGS

Use this to set your TV's video picture settings.

Interlaced

This mode offers picture settings for Video, S-Video and 480i Component Video. The options include:

- **480 Component**
Adjusts the darkness or lightness of the opening screen logo.
- **Tint**
Adjusts the tint (or color balance) on the screen.
- **Gamma**
Adjusts the gamma (gray scale light values) on the screen.
- **Y/C Time Cor (rection)**
Y/C Time Correction controls the serif in the Chroma or Luma components of a video image relative to each other. This can compensate for poor image alignment in the video signals. Options are 0, 1 or 2.

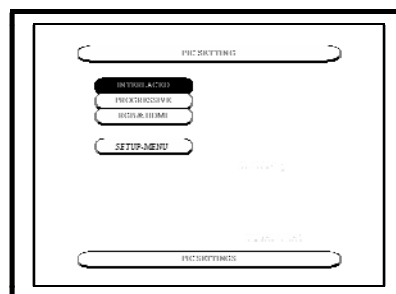
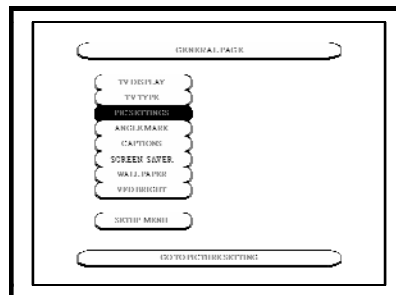

Progressive

This mode offers picture settings for 480p to 1080p Component Video.

- **Contrast**
The Contrast control applies gain to the red, green, and blue signals. It affects the luminance of the video signal (proportional to intensity) that is reproduced for a full white input signal. Once Brightness is set correctly, Contrast should be set for comfortable viewing brightness with the prevailing ambient lighting in your room.
- **Brightness**
The Brightness control could also be called the black level control. It adds or subtracts an offset, or bias, into the red, green, and blue signals. This should be adjusted so that black picture content displays as true black on your video display. Incorrect adjustment of this control is the most common problem of poor quality picture reproduction on video displays. Set the brightness control first, and then adjust the Contrast control.
- **Color**
Adjusts the intensity of the color levels on the screen.

RGB & HDMI

This mode offers picture settings for RGBs and HDMI.

- **Contrast**
The Contrast control applies gain to the red, green, and blue signals. It affects the luminance of the video signal (proportional to intensity) that is reproduced for a full white input signal. Once Brightness is set correctly, Contrast should be set for comfortable viewing brightness with the prevailing ambient lighting in your room.

CHANGING THE DEFAULT SETTINGS

- **Brightness**

The Brightness control could also be called the black level control. It adds or subtracts an offset, or bias, into the red, green, and blue signals. This should be adjusted so that black picture content displays as true black on your video display. Incorrect adjustment of this control is the most common problem of poor quality picture reproduction on video displays. Set the brightness control first, and then adjust the Contrast control.

- **Color**

Adjusts the intensity of the color levels on the screen.

ANGLE MARK

Use this to set the MULTI-ANGLE camera scenes on DVD Discs.

ON (Factory default)

Select this if you prefer to see the camera icon on-screen during multi-angle camera scenes on DVD discs.

OFF

Turns off the angle mark on screen.

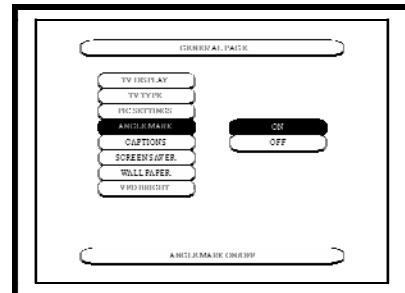

CAPTIONS

Use this to set whether or not to display the closed captions recorded on DVDs.

ON

Select this to display the captions on the screen when playing DVDs containing English captions.

OFF (Factory default)

Select this when you do not want captions playing on the screen during DVDs that contain English captions.

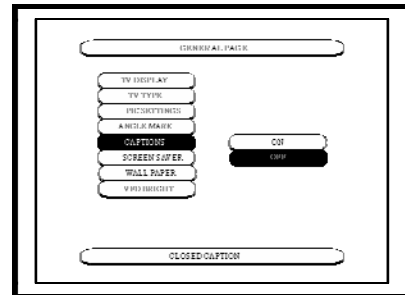

SCREEN SAVER

Use this to make sure a constant image is not displayed for too long a time, possibly creating "Burn In" on the video display.

ON (Factory default)

If a constant image is displayed on a plasma or a conventional CRT type TV, it can "burn in" leaving a ghost image on the screen.

OFF

Turns off the screen saver function for the DVD 7. Burn in is possible with some video displays in this setting. Screen saver ON is recommended.

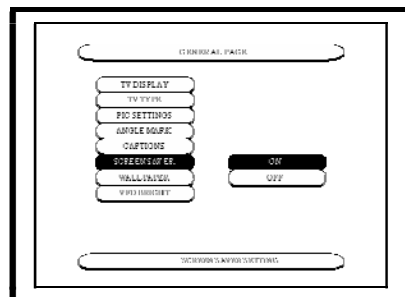

CHANGING THE DEFAULT SETTINGS

WALL PAPER

Use this to select the image to be shown on the screen in the stop mode and CD play mode.

BLUE

Select this to display a blue background on the TV display.

BLACK

Select this to display a black background on the TV display.

PICTURE (Factory default)

Select this to display the wallpaper of the Cary Audio Design logo on the TV display.

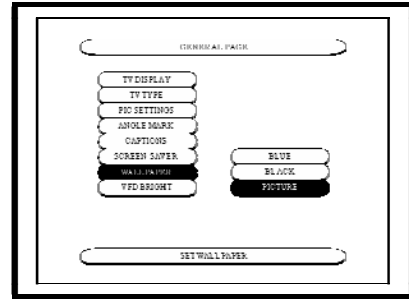

VFD BRIGHT

Use this to select the brightness of the front panel VFD Display.

OFF

The VFD display is turned off.

LOW

The brightness is set to 25% of the normal setting.

MEDIUM

The brightness is set to 50% of the normal setting.

NORMAL (Factory default)

A normal brightness is set.

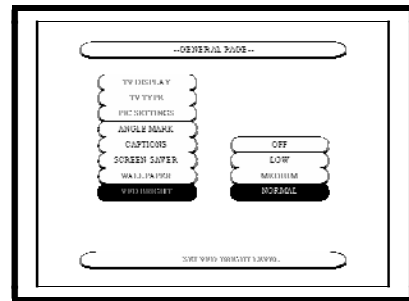

AUDIO SETUP

Choose Audio Setup and press **ENTER**. Use the **UP ▲**, **DOWN ▼**, **LEFT ◀**, and **RIGHT ▶** cursor buttons to navigate the options within Video Setup. When making changes, navigate to the desired selection and press **ENTER**. Press the **LEFT ◀** arrow to return to the list of options within Audio Setup. To exit Audio Setup, choose the **SETUP** button to return to the main SETUP menu.

HDMI OUT

Use this to select the digital output format from the HDMI jack. With an HDMI cable, both uncompressed video data and digital audio data e.g., LPCM or bit stream data such as Dolby Digital, DTS, or MPEG data) can be transmitted with just a single digital cable connector.

PCM (Factory default)

Linear Pulse Code Modulation (LPCM) data is used in the TV or Monitor, and converted to analog sound.

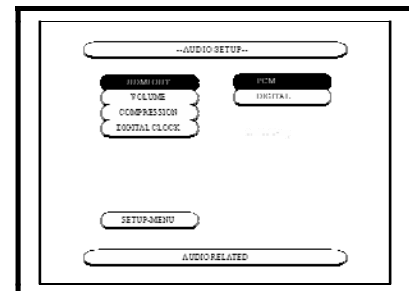

CHANGING THE DEFAULT SETTINGS

DIGITAL

DIGITAL data is used in a Surround Sound Processor.

Note: The HDMI output of this unit can be connected to a DVI jack on a TV or other device using a conversion adapter. In this case, it is necessary to use a TV or display with an HDCP compatible DVI input.

There may be no image output or sound output if connected to a TV or display that is not compatible with the above format.

Refer to the instruction manual of the TV or display to be connected to this unit for detailed information regarding the HDMI terminal.

VOLUME

Use this to select whether the analog output can have variable volume control.

ON (Factory default)

RCA offers 3.0 volts and XLR offers 6.0 volts variable level output in stereo analog connections. Use the remote control to adjust the volume from 0 to 64.

OFF

RCA offers 2.0 volts and XLR offers 4.4 volts fixed level output in stereo Left and Right analog connections.

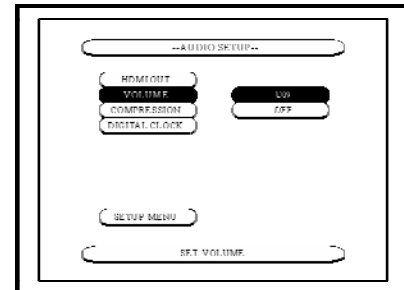

COMPRESSION

Use this to set the dynamic range output when playing Dolby Digital discs.

OFF (Factory default)

Select OFF to have standard full dynamic range sound playback.

MIDDLE

Select MIDDLE to have powerful sound with clear dialog tracks even when the volume is low. This setting is suited for watching DVDs late at night with the volume low. (This setting is only valid for DVDs recorded in Dolby Digital.)

FULL

Select FULL to achieve a powerful sound with clear dialog tracks even when the volume is low. This setting is suited for watching DVDs late at night with the volume low. (This setting is only valid for DVDs recorded in Dolby Digital.) The FULL setting and the MIDDLE setting reduce the overall dynamic range of movies for late night viewing, to keep dialog easy to hear while reducing the volume level changes in a Dolby Digital soundtrack.

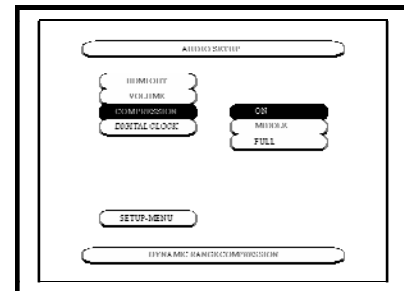

CHANGING THE DEFAULT SETTINGS

DIGITAL CLOCK (48kHz/96kHz)

Use this to set the Digital Clock output when playing the DVDs recorded in linear PCM audio.

LPCM 48K

Linear PCM and packed PCM signals are converted to 44.1 kHz or 48 kHz and output. (The PCM digital audio output signals are converted to 48 kHz or less in consideration of copyrights.)

When making digital connections to an AV amplifier that is not compatible with 96 kHz/88.2 kHz digital input signals.

When playing DVDs recorded in linear PCM or packed PCM and the unit is set to output digital and analog audio signals simultaneously, the analog audio output signals are also converted to 48 kHz or below, so we recommend setting to "LPCM 96k" and also making analog connections.

LPCM 96k (Factory default)

When playing linear PCM or packed PCM DVDs that are not copyright protected for 2-channel PCM audio signal up to 96 kHz, linear PCM signal are output as such without being converted from the digital outputs. When playing copyright protected linear PCM or packed PCM DVDs, in consideration of copyright, no digital signals are output for sources exceeding 48 kHz/16 bits.

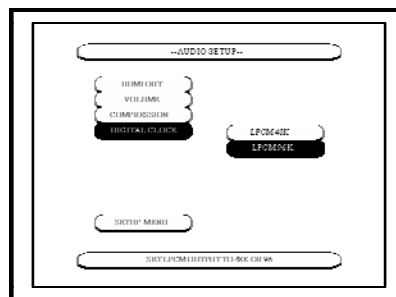

DISC SETUP

Choose Disc Setup and press **ENTER**. Use the **UP ▲**, **DOWN ▼**, **LEFT ◀**, and **RIGHT ▶** cursor buttons to navigate the options within Disc Setup. When making changes, navigate to the desired selection and press **ENTER**. Press the **LEFT ◀** arrow to return to the list of options within Disc Setup. To exit Disc Setup, choose the **SETUP** button to return to the main **SETUP** menu.

AUDIO

Use this to set the language of the sound output from the speakers.

- ENGLISH (default) - Select if you want the sound in English.
- FRENCH - Select if you want the sound in French.
- SPANISH - Select if you want the sound in Spanish.
- GERMAN - Select if you want the sound in German.
- JAPANESE - Select if you want the sound in Japanese.
- OTHERS - Use the numbers to input a language selection.

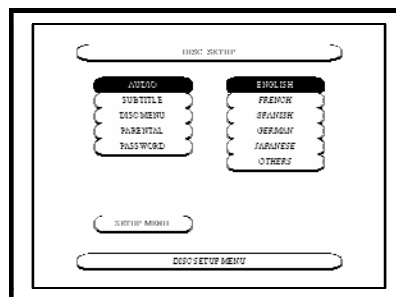

(Some disks require these settings to be made in their own SETUP menu.)

CHANGING THE DEFAULT SETTINGS

SUBTITLE

Use this to set the language of the subtitles displayed on the TV.

- ENGLISH (default) - Select if you want the subtitles in English.
- FRENCH - Select if you want the subtitles in French.
- SPANISH - Select if you want the subtitles in Spanish.
- GERMAN - Select if you want the subtitles in German.
- JAPANESE - Select if you want the subtitles in Japanese.
- OTHERS - Use the numbers to input a language selection.
- OFF - Select if you do not want to display the subtitles.

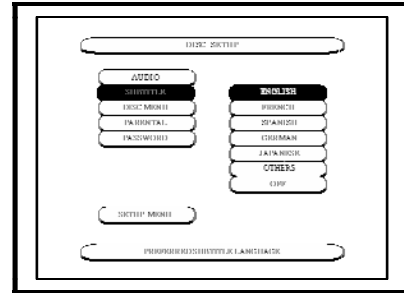

(Some disks require these settings to be made in their own SETUP menu.)

DISC MENU

Use this to set the language of the menus recorded on the disc (top menu, etc.)

- ENGLISH (default) - Select if you want the menus in English.
- FRENCH - Select if you want the menus in French.
- SPANISH - Select if you want the menus in Spanish.
- GERMAN - Select if you want the menus in German.
- JAPANESE - Select if you want the menus in Japanese.
- OTHERS - Use the numbers to input a language selection.

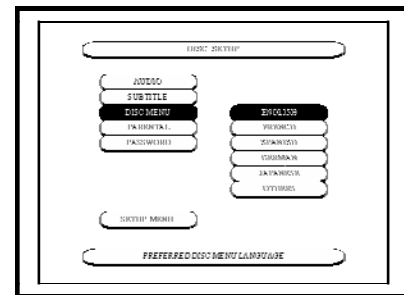

(Some disks require these settings to be made in their own SETUP menu.)

PARENTAL

Use the Parental Disc Setting to restrict playback of certain DVDs for certain audiences. The levels of restriction, which are similar to rating codes used in movie theaters, are listed below:

- **NO_PARENTAL** (Factory default)
- **2**
- **3 (PG)**
- **4 (PG-13)**
- **5**
- **6 (PG-R)**
- **7 (NC-17)**
- **8 (X)**

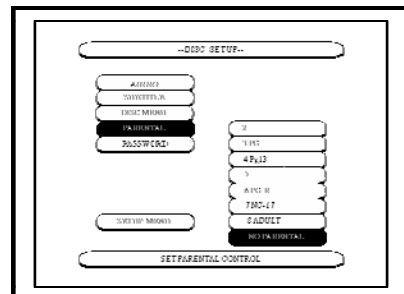

Note: Even with adult DVDs, viewing cannot be restricted unless the restriction level is recorded on the disc. It is however possible to disable playback of all DVDs.

CHANGING THE DEFAULT SETTINGS

Movie Rating Guidelines

NR – Not Rated

This is a film which has no rating. In many cases these films were imported from countries which do not use the MPAA rating system. Other NR films may be from amateur producers who didn't intend to have their film widely released. NR Programming may contain all types of programming including children's programming, foreign programs, or adult material.

G – General Audience

In the opinion of the review board, these films contain nothing in the way of sexual content, violence, or language that would be unsuitable for audience of any age.

PG – Parental Guidance

Parental Guidance means the movie may contain some contents such as mild violence, some brief nudity, and strong language. The contents are not deemed intense.

PG-13 – Parents Strongly Cautioned

Parents with children under 13 are cautioned that the content of movies with this rating may include more explicit sexual, language, and violence content than movies rated PG.

R – Restricted

These films contain material that is explicit in nature and is not recommended for unsupervised children under the age of 17.

NC-17 – No One Under 17

These movies contain content which most parents feel is inappropriate for their children under 17 to view. Content can consist of strong language, nudity, violence, and suggestive or explicit subject matter.

X – No One under 18

These movies contain inappropriate material for anyone under 18.

PASSWORD

Use this to change the password that controls the Parental settings above. The set's password is set to "3308" by default.

CHANGE

Use the number buttons to input a 4-digit password, then press the ENTER button. Make sure you do not forget the password because the setting cannot be changed without entering the correct password.

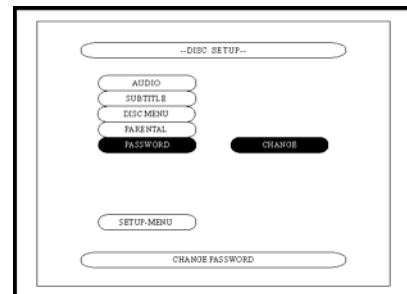

CHANGING THE DEFAULT SETTINGS

PROGRESSIVE SETUP

Choose Progressive Setup and press **ENTER**. Use the **UP ▲**, **DOWN ▼**, **LEFT ◀**, and **RIGHT ▶** cursor buttons to navigate the options within Progressive Setup. When making changes, navigate to the desired selection and press **ENTER**. Press the **LEFT ◀** arrow to return to the list of options within Progressive Setup. To exit Progressive Setup, choose the SETUP button to return to the main SETUP menu.

COMPONENT

Use this to select the YUV component output mode.

480P/576P (Factory default)

YUV (480P/576P) component video signal is output from COMPONENT PROGRESSIVE OUTPUT terminals. 480P is NTSC progressive and 576P is PAL progressive.

720P

YUV (720P) component video signal is output from COMPONENT PROGRESSIVE OUTPUT terminals.

1080i

YUV (1080i) component video signal is output from COMPONENT PROGRESSIVE OUTPUT terminals.

1080P

YUV (1080P) component video signal is output from COMPONENT PROGRESSIVE OUTPUT terminals.



Note: There will be no image shown on the display if it is not capable of working at the chosen video setting. Do not try to use incorrect video settings for your display to avoid potential damage to the video display. Refer to the instruction manual of the TV or display to be connected to the unit for detailed information regarding the component jacks.

CHANGING THE DEFAULT SETTINGS

RGB/HDMI

Use this to select the RGB+HV SYNC output and HDMI output linked setting output mode.

480P/576P (Factory default)

RGB 480P/576P progressive scan analog video signals are output from the RGB jacks.

RGB 480P/576P digital video signals are output from the HDMI terminal, with LPCM or DIGITAL audio signals.

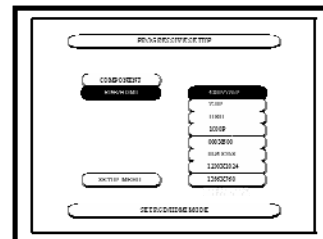

720P

RGB 720P progressive scan analog video signals are output from the RGB jacks.

RGB 720P digital video signals are output from the HDMI terminal, with LPCM or DIGITAL audio signals.

1080I

RGB 1080I interlaced analog video signals are output from the RGB jacks.

RGB 1080I digital video signals are output from the HDMI terminal, with LPCM or DIGITAL audio signals.

1080P

RGB 1080P progressive scan analog video signals are output from the RGB jacks.

RGB 1080P digital video signals are output from the HDMI terminal, with LPCM or DIGITAL audio signals.

800x600

RGB 800x600 analog video signals are output from the RGB jacks.

RGB 800x600 digital video signals are output in HDMI terminal, with LPCM or DIGITAL audio signals.

1024x768

RGB 1024x768 analog video signals are output from the RGB jacks.

RGB 1024x768 digital video signals are output from the HDMI terminal, with LPCM or DIGITAL audio signals.

1280x1024

RGB 1280x1024 analog video signals are output from the RGB jacks.

RGB 1280x1024 digital video signals are output from the HDMI terminal, with LPCM or DIGITAL audio signals.

1366x768

RGB 1366x768 analog video signals are output from the RGB jacks.

RGB 1366x768 digital video signals are output from the HDMI terminal, with LPCM or DIGITAL audio signals.

Note: The HDMI output of this unit can be connected to a DVI jack on a TV or other device using an HDMI > DVI conversion adapter. In this case, it is necessary to use a TV or display with an HDCP compatible DVI input. There may be no image output if connected to a TV or display that is not compatible with the above format. Refer to the instruction manual of the TV or display to be connected to the unit for detailed information regarding the RGB+HV SYNC jacks.

CHANGING THE DEFAULT SETTINGS

AV SYNC

Choose AV SYNC Setup and press **ENTER**. Use the **UP ▲**, **DOWN ▼**, **LEFT ◀**, and **RIGHT ▶** cursor buttons to navigate the options within AV SYNC Setup. When making changes, navigate to the desired selection and press **ENTER**. Press the **LEFT ◀** arrow to return to the list of options within AV SYNC Setup. To exit AV SYNC Setup, choose the SETUP button to return to the main SETUP menu.

DIGITAL OUT DELAY

Use this to select the digital audio output delay time setting. (TOSLINK & COAXIAL digital audio output only)

Use this to set the DIGITAL VIDEO and DIGITAL AUDIO OUTPUT so they are synchronized.

0 (Factory default)

No delay is output.

1 - 600 MS

You can select from 1 to 600 ms time delay in the digital audio output. Video processing of a DVD disk to a higher video setting, for example 720p progressive output, takes a little bit of extra time. If you notice any timing discrepancy between the sound and the video image you can adjust the timing of the AV SYNC circuit to keep the video action and the audio signal "in synch".



PLAYBACK

STARTING A DISC

1. Turn on the Power.
 - Press the power button, the power turns on and the standby indicator lights turns off.
 - When in standby mode, press the POWER button on remote control unit.
2. Press the OPEN/CLOSE button to open the disc tray.
3. Place the disc in the disc tray.
4. Press the OPEN/CLOSE button.
 - For many interactive DVDs and video CDs with playback control, a menu screen appears. In this case use the procedure in Step F to select the desired item.
 - Interactive DVDs are DVDs including multiple camera angles, alternate endings for stories, and other extras.
5. Press the PLAY button.
6. Use the **UP ▲**, **DOWN ▼**, **LEFT ◀**, and **RIGHT ▶** cursor buttons to select the desired item.
 - For some discs there is a second menu screen. If so, press the **▶▶** button to display the next menu screen. (See the disc's jacket.)
 - The cursor buttons (▲, ▼, ◀ and ▶) do not work for video CDs. Instead, use the number buttons to select the desired item.
7. Press the ENTER button.
 - The desired item is selected and playback starts.
 - You can return to the menu screen by pressing the MENU/TITLE button while the DVD is playing, though this depends on the disc.
 - Press the PLAY button during playback of a video CD to return to the menu screen.

Note: If a stop type hand symbol appears on the TV screen while buttons are being operated, that operation is not possible on the DVD 7 or with that disc. Do not place more than one disc in the disc tray. The disc keeps turning while the menu screen is displayed on the TV screen.

STOPPING PLAYBACK

1. During playback, press the STOP button on the main unit or the remote control unit. Playback will stop and the wallpaper is displayed.
2. Resume play memory function. (DVD only)
3. With the DVD 7, when the STOP button is pressed, that position is stored in the memory. At that time, "PLAY" flashes on the display. When the PLAY button is pressed, playback resumes from the position where it was stopped. The resume play memory function is cancelled if the disc tray is opened or the STOP button is pressed a second time.
4. If you do not want to continue playing the disc or to save electricity press the POWER button on the main unit to turn the power off or press the POWER OFF button on the remote control unit to set the power to the standby mode.

PLAYBACK

PAUSING PLAYBACK

During playback, press the PAUSE button on the remote control. Press the PAUSE button a second time or press the PLAY button to resume normal playback.

FORWARD/REVERSE SEARCHING

During playback, press one of the REW/FF buttons on the remote control unit.

◀◀ : Reverse direction

▶▶ : Forward direction

When pressed again, the search speed increases (in four steps). Increases are variable in 4 steps for CDs, 4 steps for DVD video (movie part), DVD video and video CD discs. Press the PLAY button to resume normal playback.

Note: In some cases the menu screen may reappear when one of the REW/FF buttons is pressed during menu playback on a video CD.

SKIPPING TO THE BEGINNING OF CHAPTERS OR TRACKS

Cueing using the SKIP button

During playback, press one of the skip buttons on the main unit or the remote control unit.

◀◀ : Reverse direction (PREVIOUS)

▶▶ : Forward direction (NEXT)

A track or chapter is skipped for each time the SKIP button is pressed. When the skip back button is pressed once, the pickup returns to the beginning of the currently playing chapter or track.

Note: In some cases the menu screen may reappear when one of the SKIP buttons is pressed during menu playback on a video CD.

Cueing Using the Number Buttons

Press the GOTO MODE button during playback. The GOTO mode switches each time the button is pressed changing the Chapter or Track number. Once you have made your selection, press PLAY.

For DVD video discs: Title (whole disk) / Chapter (one section of a disk)

For CDs and video CDs: Track Only

When the GOTO mode is set by pressing the GOTO MODE button, the memory is stored until the button is pressed again.

However, the GOTO mode returns to the default mode when the power is turned OFF. Use the number buttons to input the number to be played.

Note: Some DVD video and video CD discs do not operate as described in this manual due to the intentions of the discs' producers.

PLAYBACK

PLAYING FRAME BY FRAME (FOR DVDS AND VIDEO CDS ONLY)

During playback, press the PAUSE button on the remote control.

- The picture moves forward one frame each time the button is pressed again.
- Press the PLAY button to resume normal playback.
- With DVD audio discs, forward frame-by-frame skipping is only possible for the video part.

SELECTING THE STILL IMAGE

During playback, press the PREVIOUS or NEXT button on the remote control unit.

- On some discs the image cannot be selected due to the intentions of the discs' producers.

PLAYING BONUS GROUPS

- A. In the stop mode, press the TITLE button on the remote control unit to set the search mode to "GROUP".
- B. Use the number buttons to input the bonus group number.
- C. Use the number buttons on the remote control unit to input the password (3 digits), then press the ENTER button.

Playback starts from the first track in the specified group. In some cases the password must be entered on the menu screen.

In these cases, follow the instructions on the screen.

- Once the password is input, the disc can be played as many times as you want until it is removed.
- If you make a mistake when inputting the password, press the ENTER button on the remote control unit.

SERVICE AND CARE

CARE AND CLEANING

The cabinet housing and front panel of the DVD 7 may be cleaned with a soft cloth and Windex or a window cleaner. The frequency of cleaning will be governed by how many hours the DVD 7 is operated and by operating environment cleanliness.

FACTORY SERVICE

Careful consideration has been given to the design of your DVD 7 player to keep maintenance problems to a minimum. Any problems or requests for service should be referred to our Customer Service Department at 919-355-0010. DO NOT return the DVD 7 to the factory without a return authorization number (RA) from the Customer Service Department.

Cary Audio Design will assume no responsibility if the shipping company refuses to pay for damage due to your improper packing or lack of insurance should the unit be lost or damaged in shipment. Please retain and always use the original shipping carton for shipping the player.

NON-WARRANTY REPAIRS

Cary Audio Design will provide repair service for its products charging on a time and expense basis. At this time, the standard non warranty service bench fee is \$125 with all parts used for repair charged extra. This may change and is not a quote for service. Please call us at 919-355-0010 for more information about out of warranty service and repair fees.

CAUTION - Never remove or insert the back panel AC plug when the unit is on or the ac cord is plugged into the wall.

UNITED STATES LIMITED WARRANTY

Cary Audio Design warrants to the original United States purchaser for use in the United States that Cary Audio Design vacuum tube or solid state power amplifiers, surround sound processors or preamplifiers shall be free from defects in parts or workmanship for three (3) years from the date of the original purchase. Vacuum tubes, if any are used in the component, are offered a 90 day from purchase date exchange policy against defects with the exception of the CAVT 300B vacuum tube which has a (1) one year from purchase date exchange policy. Any digital drive design, whether a Cary Audio Design CD or SACD player or a Cary Cinema DVD player, has a limited one year parts and labor warranty against defects in manufacture. This is a limited warrant, for the original purchaser only and does not transfer to any subsequent owner.

During the limited warranty period, Cary Audio Design or an authorized Cary Audio Design service facility will provide free of charge both parts and labor necessary to correct any defects in material or workmanship.

To obtain such warranty service, the original purchaser must:

1. Complete and send in the warranty Registration Card within 15 days of purchase.
2. If claiming service the owner must send a fully filled in copy of the original sales receipt along with any unit sent in for service showing the AUTHORIZED CARY AUDIO DESIGN DEALER'S name, the new selling price, the buyer's name, e-mail or phone number and address on the receipt. Blank receipts will NOT validate the limited warranty for service.
3. Notify Cary Audio Design as soon as possible after the discovery of a possible defect and submit the following information to determine eligibility for warranty:
 - (a) The model number and serial number;
 - (b) A fully filled in copy of the original sales receipt showing the original selling price, purchasers name and address filled in by an AUTHORIZED CARY AUDIO DESIGN DEALER with the original date of purchase shown on the form;
 - (c) a detailed description of the problem.
4. Deliver the product to Cary Audio Design or the nearest authorized service facility or ship with all freight and insurance charges prepaid, in its original packing container or equivalent, to Cary Audio.

Correct maintenance, repair and use are important to obtain performance from this product. Therefore, please carefully read the Operating Manual. This warranty does not apply to any defect that Cary Audio Design in its sole discretion determines is due to:

1. Improper maintenance or repair, including the installation of parts or accessories that do not conform to the quality and the specifications of the original parts.
2. Misuse, abuse, neglect or improper installation.
3. Accidental or incidental damage.

WARRANTY DISCLAIMER

Except for the express warranties stated herein, Cary Audio Design disclaims all other warranties including, without limitation, all implied warranties of merchantability and fitness for a particular purpose. The foregoing constitutes Cary Audio Design's entire obligation with respect to this product, and the original purchaser and any user or owner shall have no other claim for incidental or consequential damages. Some states do not allow the exclusion or limitation of incidental or consequential damages, so the above limitation and exclusion may not apply to you. This warranty gives legal rights and you may also have other rights, which vary from state to state.

EXCLUSIVE REMEDY

Notwithstanding the foregoing, the purchaser's exclusive remedy for any breach of warranty, express or implied, is limited to the repair or replacement of the defective unit or the refund of the purchase price, at the option of Cary Audio Design. Under no circumstances is Cary Audio Design liable for incidental or consequential damages. Any implied warranties imposed by law terminate one (1) year from the date of purchase.

INTERNATIONAL PURCHASERS (Export markets)

Cary Audio Design warrants its merchandise to purchasers within the United States exclusively for use within the United States of America. It provides no other warranties, expressed or implied. If you are living outside the USA, please consult with your local dealer or distributor to determine the details of your local warranty.

CARY AUDIO DESIGN

1020 Goodworth Drive, Apex, NC 27539
phone 919-355-0010
fax 919-355-0013
www.caryaudio.com

