

Plain Paper Copier

FP-7742/7750

Options

i-ADF (FA-A888)/ADF (FA-A505)/Sorter (FA-S575/S680)

System Console (FA-DS82)/LCC (FA-MA301)

Before operating

Operating Guide

Making Copies

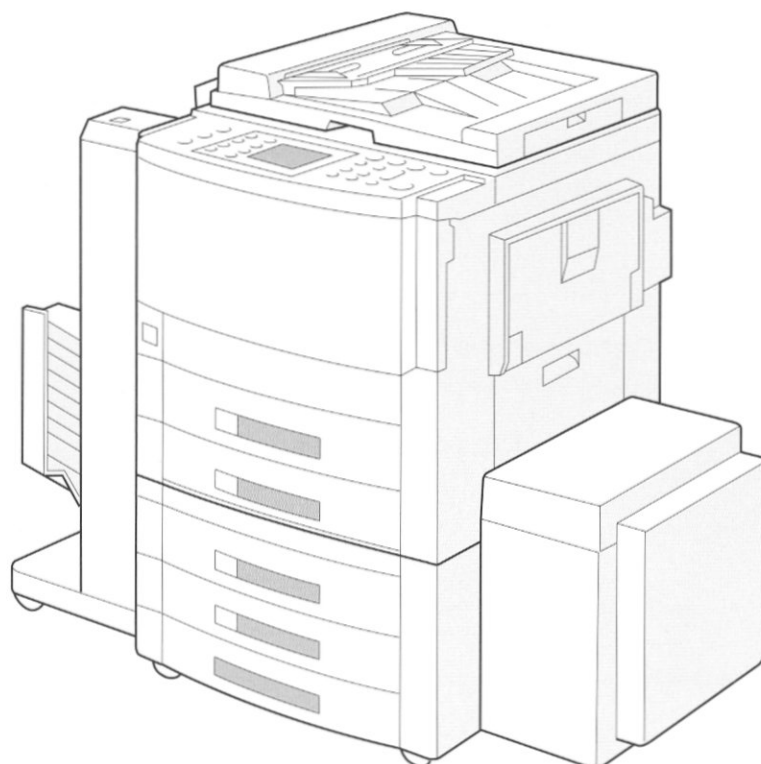

Specifications

Before operating this copier, please read these instructions completely and keep this operating guide for future reference.

The FP-7742/7750 with options (See P.42)

Troubleshooting

Operation Chart

Common features and usage

Basic Operation

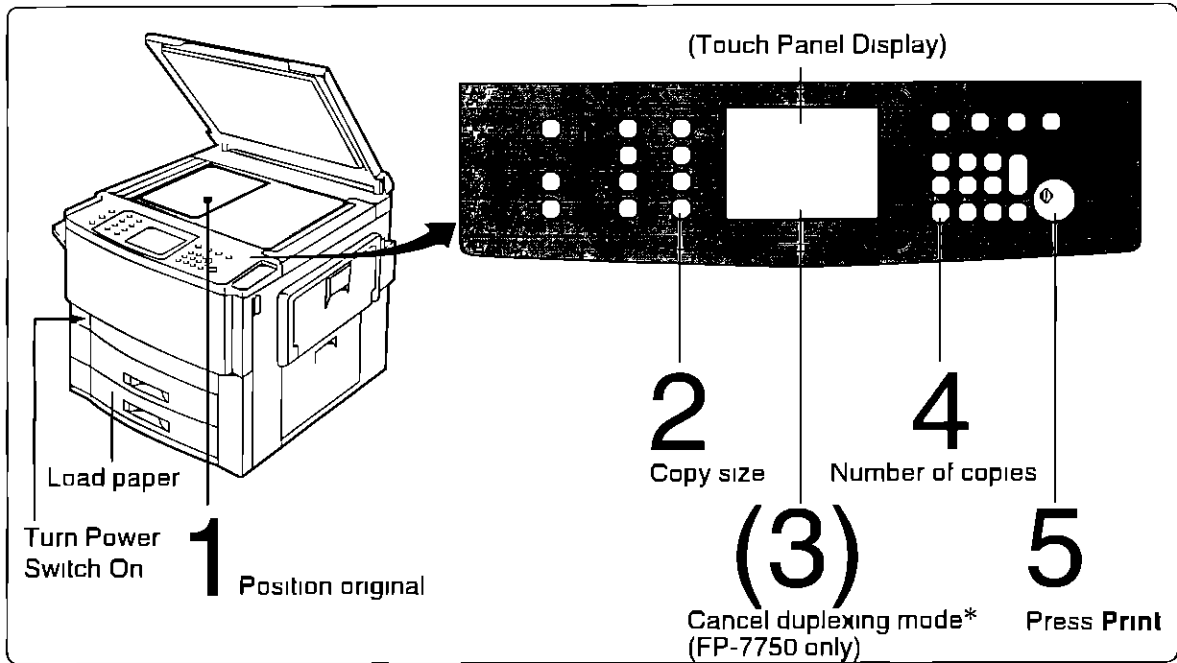

Position of the original

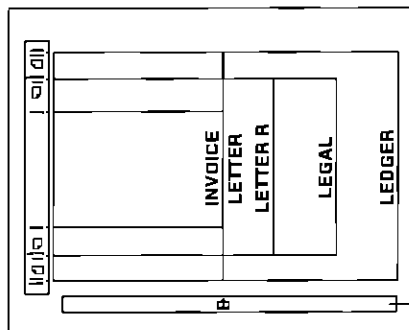

- Face Down on platen and in ADF (FA-A505)
Face Up in i-ADF (FA-A888)
- If the original is not positioned properly, a portion of the original may not be copied
- For originals smaller than invoice size, align with center of left original guide and select invoice

Common Features

Follow these steps for each copy job



Full Size Copying
(See P 11)

1 → (3) → 4 → 5



Reduction or Enlargement
(See P 12)

1 → 2 → (3) → 4 → 5

NOTE

* The FP-7750 is initially set to duplexing mode (1 2)
When copying one-sided copies, touch key to cancel the duplexing mode
(See P 10)

Touch Panel Display

Function Categories

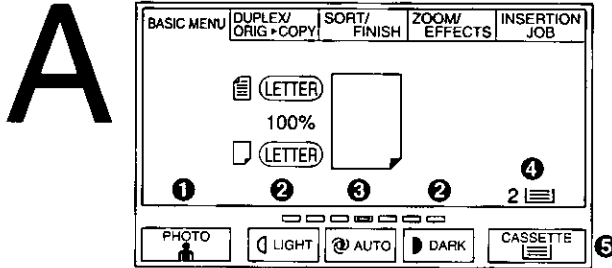

- Basic Menu (See P 10)**
- ① Photo Mode Key
 - ② Exposure Control keys
 - ③ Auto Exposure Key
 - ④ Current feed location selected
 - ⑤ Cassette Selection Key

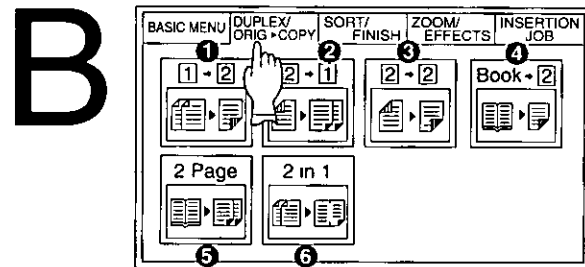

- Duplex/Original > Copy (See P 14)**
- ① 1 → 2 Copy Key
 - ② 2 → 1 Copy Key
 - ③ 2 → 2 Copy key
 - ④ Book → 2 Copy Key
 - ⑤ 2 Page Copy Key
 - ⑥ 2 in 1 Copy Key

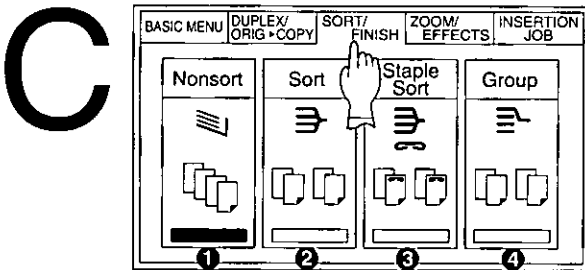

- Sort/Finishing (See P 19)**
- ① Nonsort Mode Key
 - ② Sort Mode Key
 - ③ Staple Sort Mode Key
 - ④ Group Mode Key

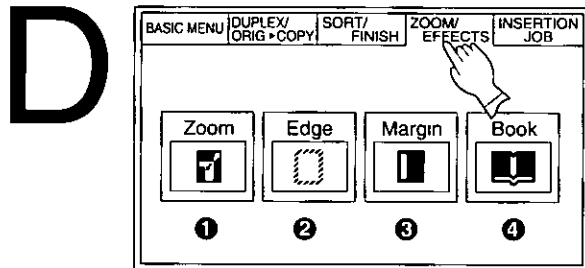

- Zoom/Effects (See P 22)**
- ① Zoom Key
 - ② Edge Mode Key
 - ③ Margin Mode Key
 - ④ Book Mode Key

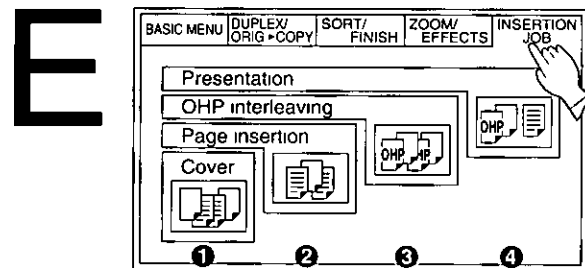

- Insertion job (See P 26)**
- ① Cover Mode Key
 - ② Page Insertion Mode Key
 - ③ OHP Interleaving Mode Key
 - ④ Presentation Mode Key

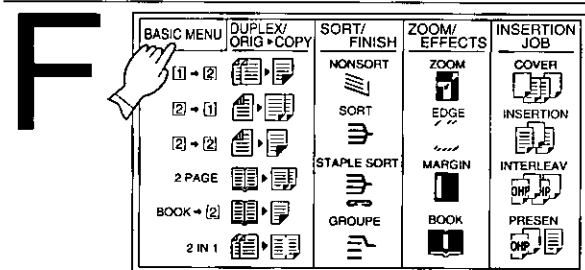

- Basic Menu Selection**
- Displays all functions when touching Basic Menu Key
 - Touch Basic Menu Key again to return to the basic screen

Energy Star

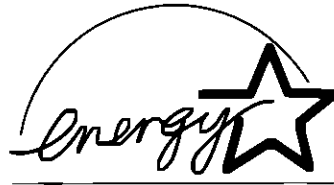

The FP-7742 & FP-7750 copiers comply with Tier 2 of the Environmental Protection Agency's Energy Star Program. This voluntary program specifies certain energy consumption and usage standards for copiers. Specifically, the FP-7750 will automatically default to duplexing or two-sided copying mode when more than one original is placed in the document feeder. In addition, both the FP-7742 & FP-7750 will automatically "power down" after a specified period of non-use. The use of these Energy Star compliant copiers will reduce energy consumption and ultimately benefit the environment.

The default functions can be adjusted depending on your office requirements. Please see your authorized Panasonic copier dealer for more details.

Table of Contents

Precautions		6
	■ Control Panel	8

Making Copies

Basic Menu		10
	■ Full Size Copying	11
	■ Reduction or Enlargement Copying	12
	■ Using the Sheet Bypass	13
Duplex/Original ▶ Copy		14
	■ 1 → 2/2 → 1 Copy	15
	■ 2 → 2/2 Page Copy	16
	■ Book → 2 Copy	17
	■ 2 in 1 Copy	18
Sort/Finishing		19
	■ Procedure	20
Zoom/Effects		22
	■ Zoom Copying	23
	■ Edge/Margin/Book Mode	24
Insertion Job		26
	■ Cover	27
	■ Page Insertion	28
	■ OHP Interleaving/Presentation	29
Other Features		30
	■ Program Copy Job	31
	■ Skyshot Mode	31
	■ Energy Saver/Interrupt	32
	■ Changing Paper Size	33
Combining Function Table		35
User Preset		36
	■ User Access	40

Options

	■ Components	42
	■ i-ADF/ADF	43
	■ Sorter	45

Maintenance

Handling		
	■ Adding Paper	47
	■ Adding Toner	49
	■ Removing a Paper Misfeed	51
Checking		
	■ Troubleshooting	61

Specifications

	■ FP-7742/7750, FA-A888/A505	59
	■ FA-S575/S680, FA-DS82, FA-MA301	60

Precautions

Handling

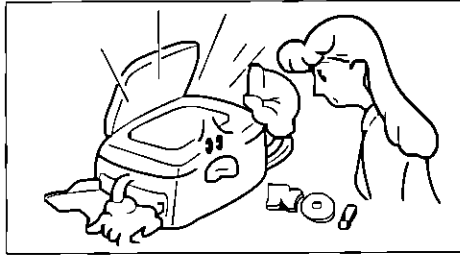

- Do not look directly at exposure lamp when copying

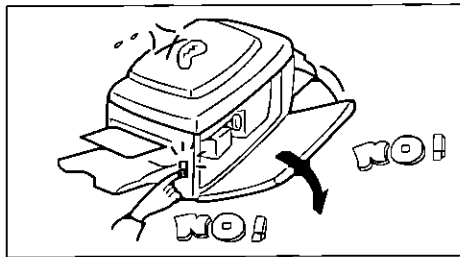

- Do not turn the power switch off or open the front panel during copying
- Do not drop paper clips or other metal objects into the copier

Toner and Paper

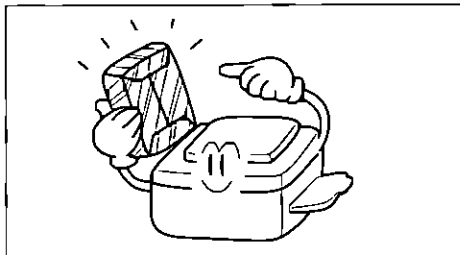

- Store toner, developer and paper in cool areas with low humidity
- High quality paper of 16 lbs - 24 lbs (15-30 lbs via sheet bypass) may be used
- For optimum performance, it is recommended that only Panasonic Brand supplies be used in the copier

Ventilation

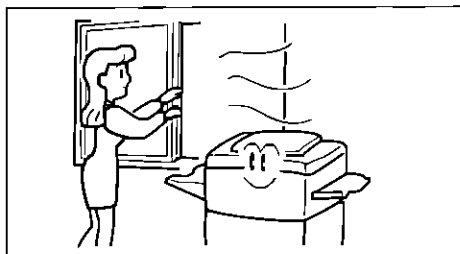

- The copier should be installed in a well-ventilated area, to minimize the ozone density in the air
- The FP-7742/7750 power consumption is 1.5 kW. A properly wired (with ground), dedicated, 15A, 120V AC outlet is required. Do not use an extension cord.

Installation

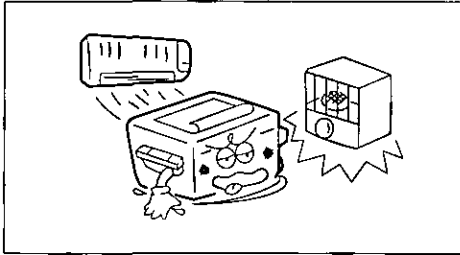

- The copier should not be installed in areas with the following conditions
 - Extremely high or low temperature and humidity
Ambient conditions
Temperature 50°F – 86°F
Relative humidity 30% – 80%
 - Area where temperature and humidity can change rapidly
 - Direct exposure to sunlight
 - Directly in air conditioning flow
 - In areas of high dust concentration
 - In areas of poor ventilation
 - In areas with chemical fume concentration
 - In areas with extreme vibration
 - With unstable or uneven conditions (floors, etc)

For U.S.A.

This equipment has been tested and found to comply with the limits for a Class A digital device, pursuant to part 15 of the FCC Rules. These limits are designed to provide reasonable protection against harmful interference when the equipment is operated in a commercial environment. This equipment generates, uses, and can radiate radio frequency energy and, if not installed and used in accordance with the instruction manual, may cause harmful interference to radio communications. Operation of this equipment in a residential area is likely to cause harmful interference in which case the user will be required to correct the interference at his/her own expense.

Any unauthorized changes or modifications to this equipment would void the users authority to operate this device.

Control Panel

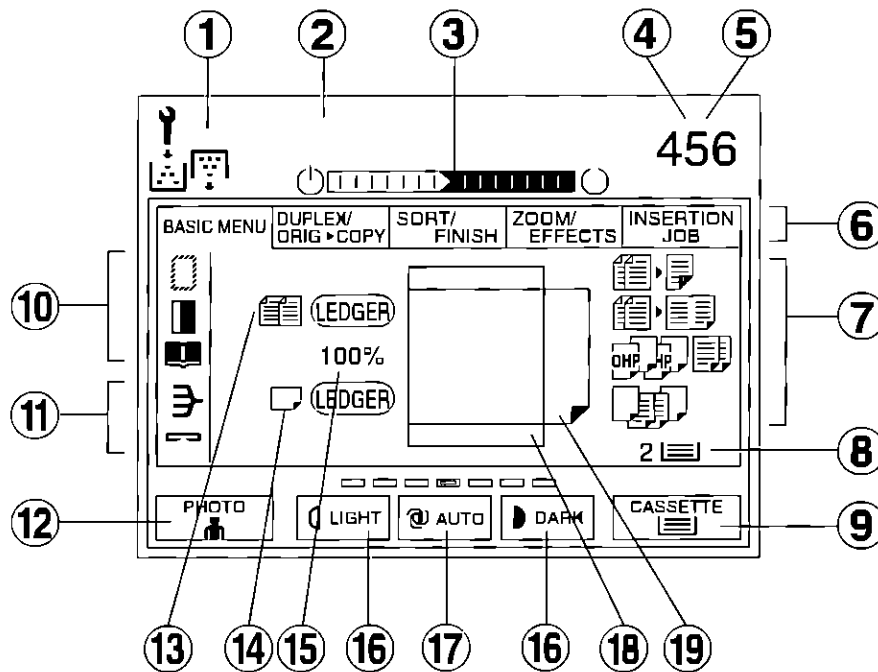
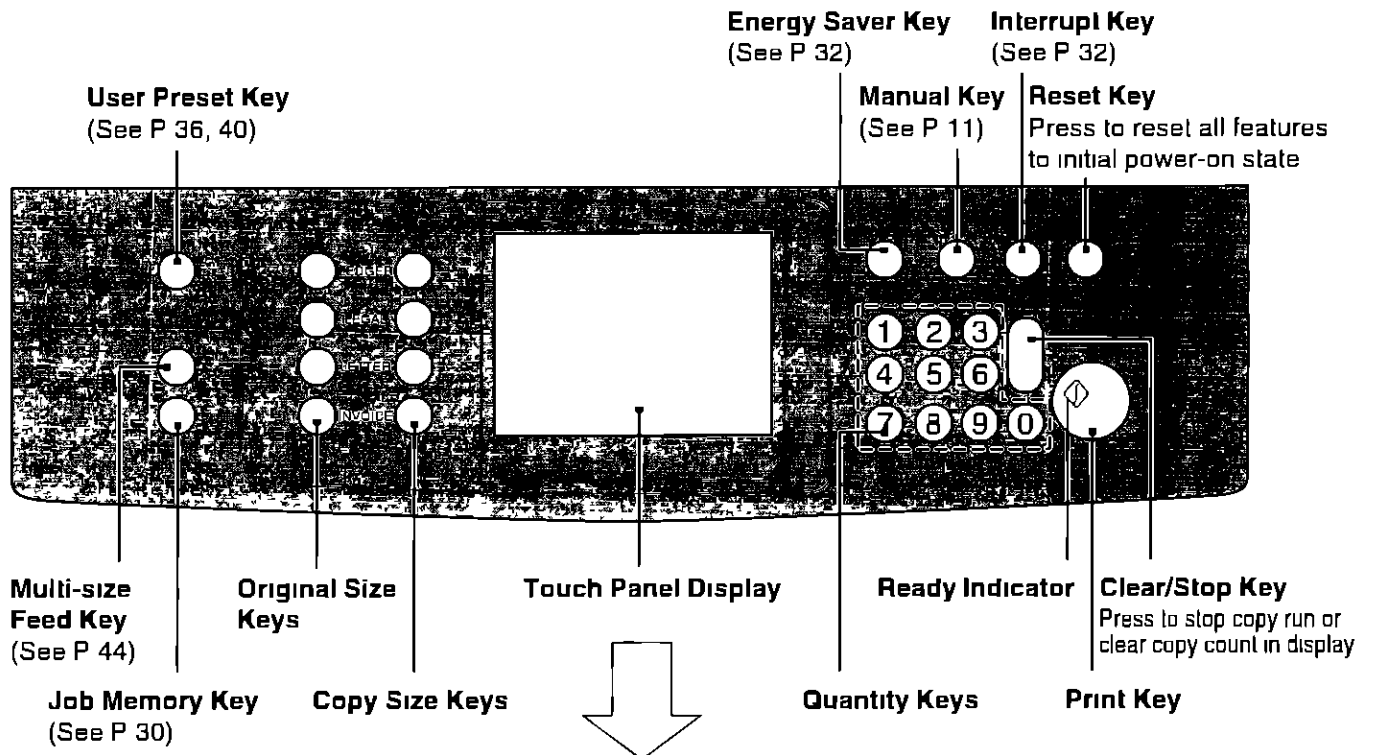

NOTE

- Adjusting the touch panel display contrast**
 Adjust brightness of the display by repeatedly pressing Ledger or Invoice original size key as necessary while pressing and holding the Clear/Stop key
 To make the display brighter Ledger size key
 To make the display darker Invoice size key

■ Touch Panel Display Indications

No	Contents	Refer to
①	Warning indications ● The copier will be disabled after this display is on for some time □ Add toner, □ Replace waste toner bottle, † Call service	P 49, 50
②	Message area	
③	Warm-up Time indication	
④	Number of copies	
⑤	Machine/User Error Code indication (U13, E1-01 etc ,)	P 61
⑥	Function Categories	P 10, 14, 19, 22, 26
⑦	Programmed Functions-1	P 14, 26
⑧	Selected Paper Tray and Paper Status indication 2 Tray position, ≡ Normal, □ Low paper, ≡ Add paper	P 47
⑨	Cassette Selection key	P 10
⑩	Programmed Functions-2	P 22
⑪	Sorter Functions	P 19, 45
⑫	PHOTO Mode Selection key	P 11
⑬	Original Direction and Size indication	
⑭	Copy Paper Direction and Size indication	
⑮	Copy Ratio indication	
⑯	Manual Exposure Select keys (Light and Dark)	P 11
⑰	Auto Exposure key	P 11
⑱	Copy Image indication	
⑲	Paper size and direction indication	

CAUTION

- Use soft finger pressure only to activate touch Screen panel. DO NOT USE SHARP OBJECTS such as pens, fingernails etc , as this may damage the panel

Basic Menu

Initial Screen

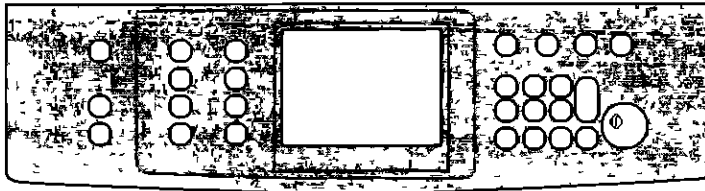

FP-7742

FP-7750

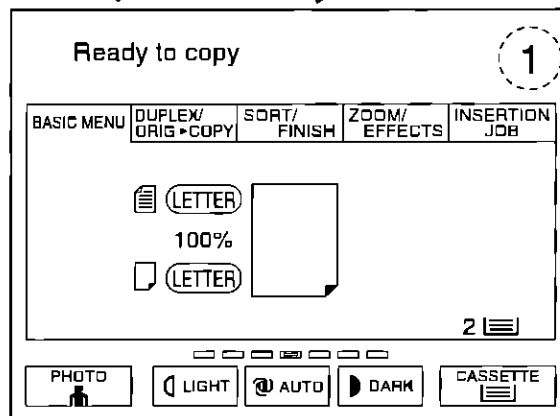
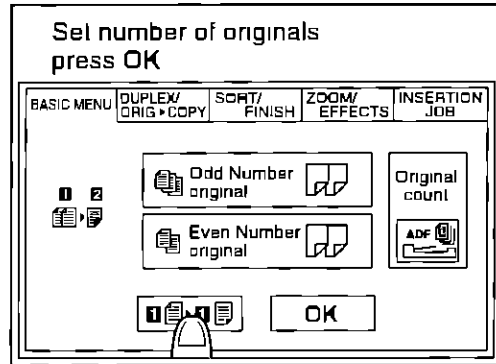

(When placing Letter size originals)

- To make 1-sided copies, touch copy key
- Input the code number, if appears
- Touch CASSETTE Key if necessary

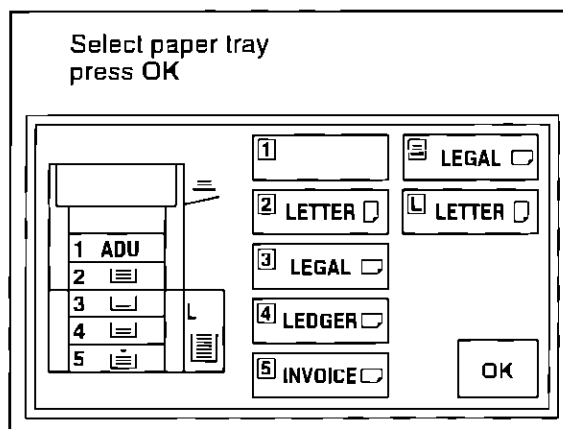

- Select paper tray required
- Touch OK key

Full Size Copying

When copying the same size as the original (1:1)

- Copy size and copy density are automatically selected.

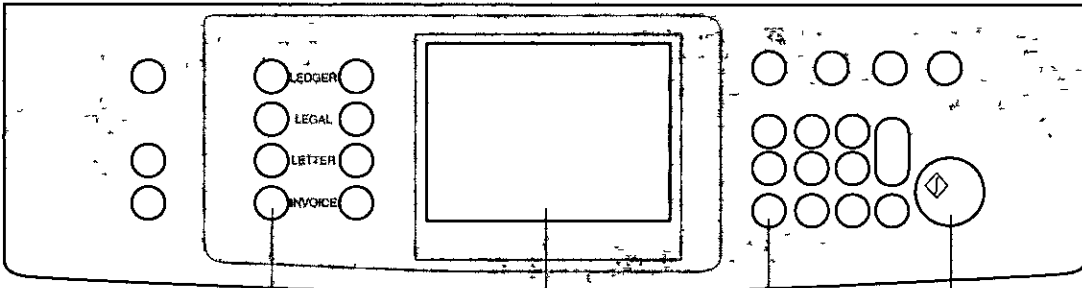

- 1** Position original
- 2** Number of copies Up to 999
- 3** Press Print

- When manually selecting exposure control or original size:

Select exposure control

- Press the Light or Dark key
- Press the Photo key to copy photos and halftones

Select original size

- Press Manual key
- Select original size with Original Size key

- Benefits of Quantum™ Technology**
The FP-7742/7750 features Quantum™ Technology which utilizes an advanced form of artificial intelligence to ensure optimal copy quality and performance under varying environmental conditions, from a wide range of originals

- NOTE
- When message ADD PAPER appears, place selected paper into paper drawer/tray
 - Remove stacked copies from the exit tray every 250 sheets

Reduction or Enlargement

When copying with preset ratios

- There are 5 preset reduction and 4 preset enlargement modes.

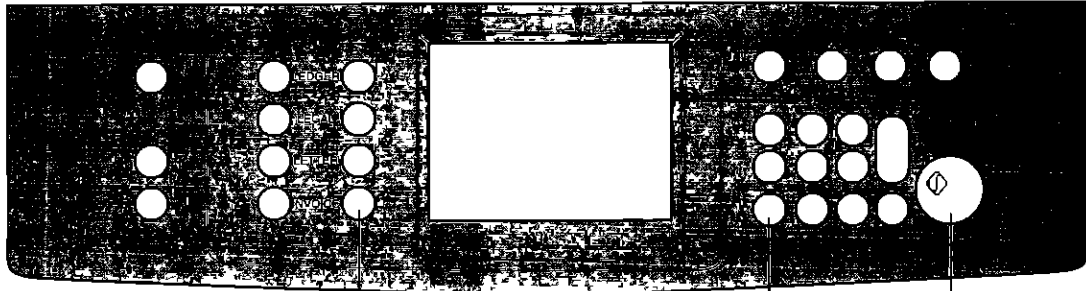

- 1 Position original
- 2 Select the copy size
(Landscape for letter size)
- 3 Number of copies
- 4 Press Print

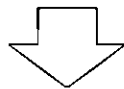

Example Reduction

Original size → Copy size

LEDGER

→

LETTER

The correct ratio is automatically selected

Reduction and enlargement ratios

Original size	Copy paper size			
	Ledger	Legal	Letter	Invoice
Ledger	100%	77	65	50
Legal	121	100	79	61
Letter	129	100	100	65
Invoice	200	155	129	100

- When changing the paper size, touch **Cassette key**

Paper Tray (CASSETTE) Key

ATTENTION

- Part of the image may be deleted if the direction of the original and copy paper do not correspond (See the image indications on page 8)

NOTE

- When copy size is different from paper size of paper drawer/tray, use sheet bypass

Using the Sheet Bypass

When copying on special paper, etc.

- To copy on letterhead, mailing labels, transparencies and odd-size paper, etc., or to use bypass as an additional paper source.

1

Position original

2

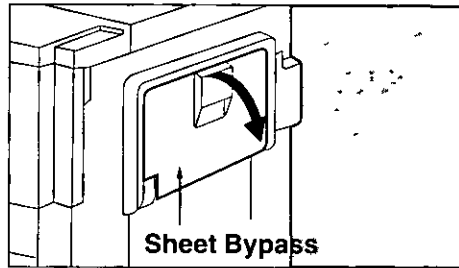

Open sheet bypass

3

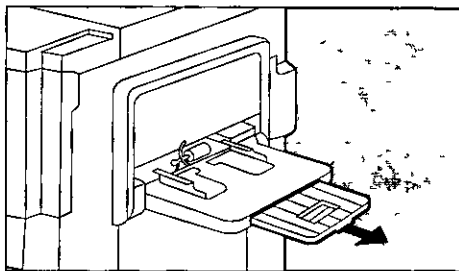

Pull out bypass tray until it stops

4

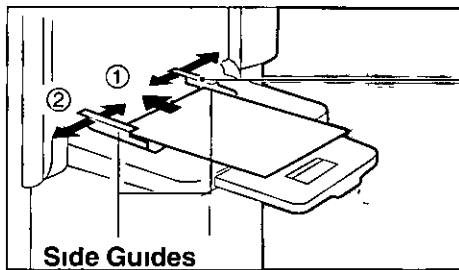

- ① Place approximately 50 sheets of paper



- ② Adjust the side guides
Incorrect adjustment may cause paper to wrinkle, misfeed or skew

5

Press Print

NOTE

- The bypass has priority over the paper drawers/trays. The copier automatically selects the sheet bypass when paper is placed in the empty bypass tray.
- Some types of mailing labels and transparency film may damage your machine. Please contact your service provider for advice regarding non-standard paper types.

Duplex/Original ► Copy

When touching DUPLEX/ORIG. ► COPY key

■ Initial Screen

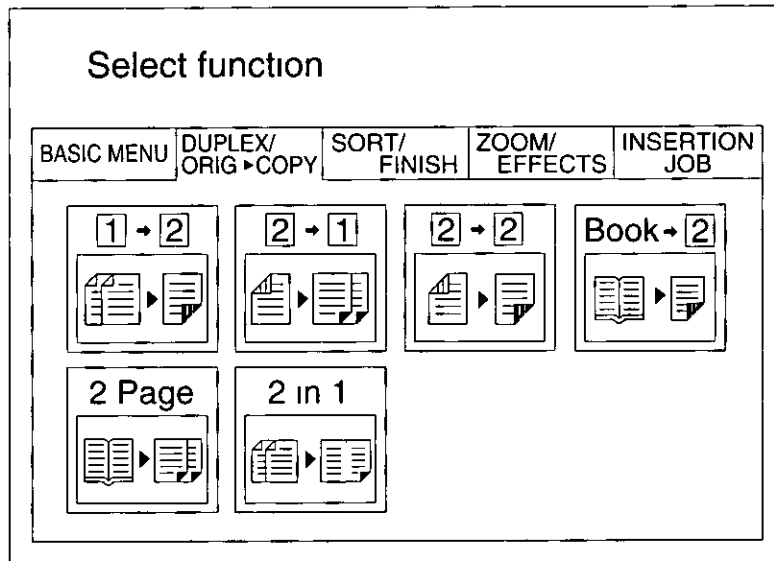

- Touch the desired key to select the function

1 → 2	From 1-sided originals to 2-sided copies	⇒ See P 15
2 → 1	From 2-sided originals to 1-sided copies	⇒ See P 15
2 → 2	From 2-sided originals to 2-sided copies	⇒ See P 16
Book → 2	From book originals to 2-sided copies	⇒ See P 17
2 Page	Copying two facing pages of a ledger size original on two separate letter size sheets	⇒ See P 16
2 in 1	From two 1-sided originals side by side to 1-sided copies	⇒ See P 18

ATTENTION

- 2-sided originals may be handled either manually or automatically using the i-ADF (FA-A888)
- To reset Duplex/Original ► Copy mode, press Reset key
- Press the reset key to feed out last copy existing in the ADU (Automatic Duplex Unit)

1 → **2/2** → **1**

■ **1 → 2 Copy**

From 1-sided originals to 2-sided copies
From Copier Platen & i-ADF/ADF

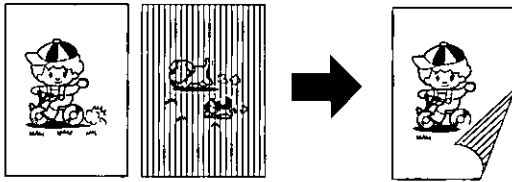

■ **2 → 1 Copy**

From 2-sided originals to 1-sided copies
Using i-ADF

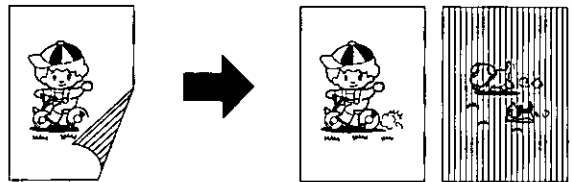

■ **Procedure**

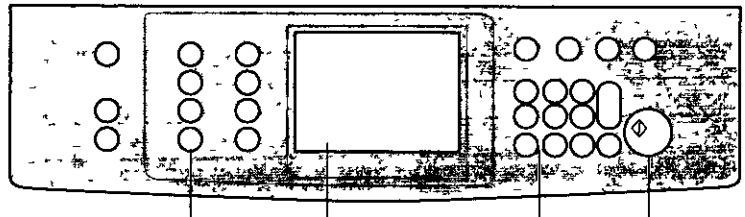
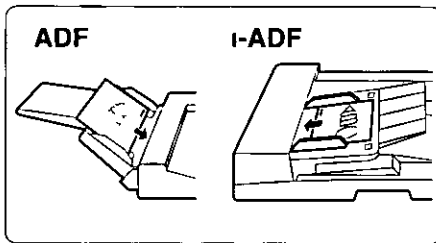

2
Position
originals

3
Count
originals
(**1** → **2** only)

(4)
Select
original size
(ADF)

1
Touch **1** → **2**
or **2** → **1** mode

5
Number of
copies
(Up to 50)

6
Press
Print

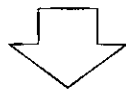

Set number of originals 1
press OK

BASIC MENU	DUPEX/ ORIG • COPY	SORT/ FINISH	ZOOM/ EFFECTS	INSERTION JOB
Odd number original		Original count		
Even number original				
CANCEL		OK		

① If number of originals is unknown, touch Original Count key

② For odd/even originals, touch Odd/Even key

③ Touch OK key

④ Return Originals to the i-ADF

NOTE

- To reset each mode, touch Cancel key on the screen
- Press the reset key to feed out last copy existing in the ADU (Automatic Duplex Unit)

Duplex/Original ▶ Copy

2 → 2/2 Page Copy

■ **2 → 2 Copy**
From 2-sided originals to 2-sided copies
Using I-ADF

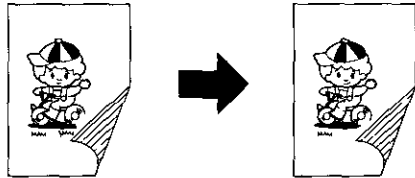

■ **2-Page Copy**
Copying two facing pages of a ledger size original on two separate letter size sheets

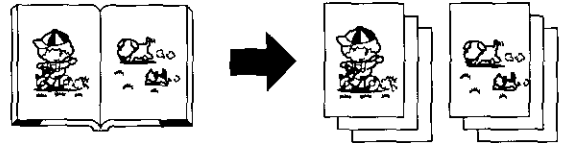

Ledger size originals only

■ Procedure

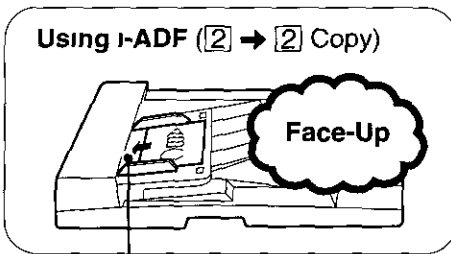

2
Position originals

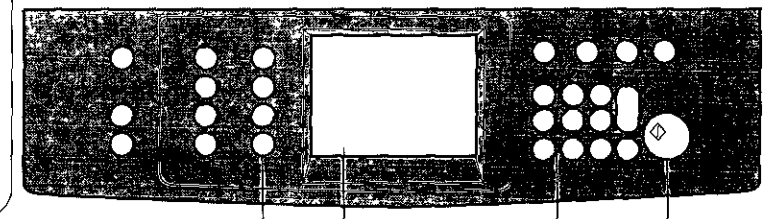

(3)
Select copy size*

1
Touch 2 → 2 or 2 Page mode

4
Number of copies
(Up to 50
in 2 → 2)

5
Press Print

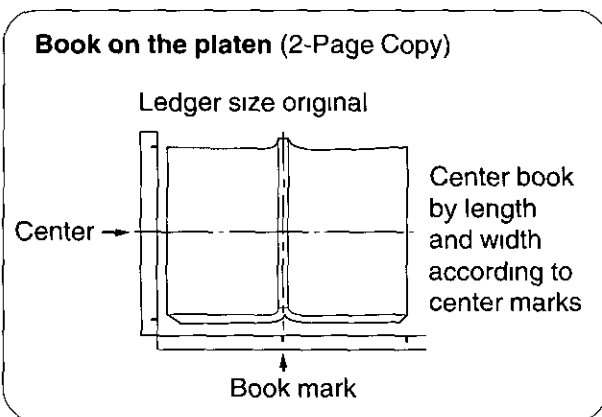

NOTE

- * For reduction or enlargement copy only
- To reset each mode, touch Cancel key on the screen
- Press the reset key to feed out last copy existing in the ADU (Automatic Duplex Unit)

Book → 2

■ Book → 2 Copy

From book originals to 2-sided copies
Ledger size originals only

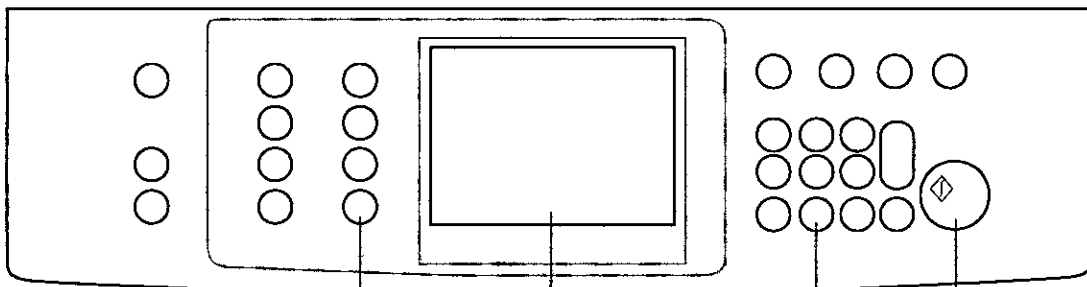
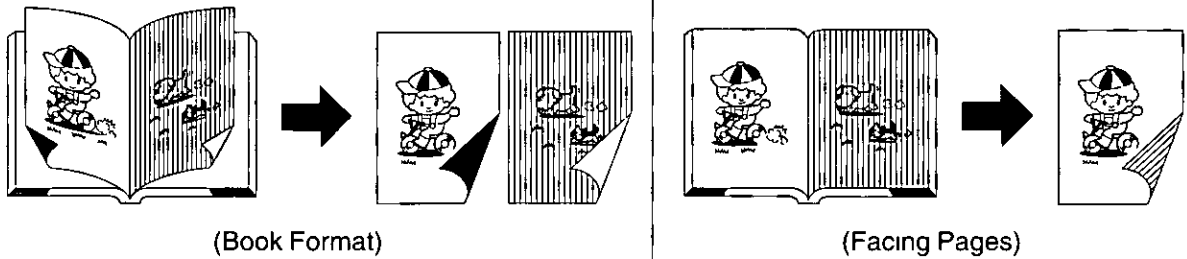

1

Position original on the Platen

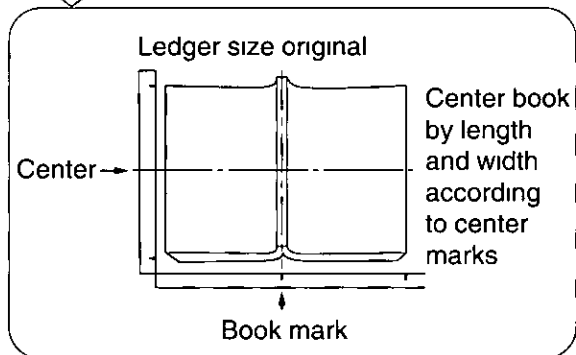
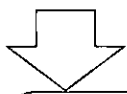

- Make copies from last page in Facing pages and Book Format mode

2

Select the copy size

3

Select Book → 2 mode and Copy format

4

Number of copies (Up to 50)

5

Press Print

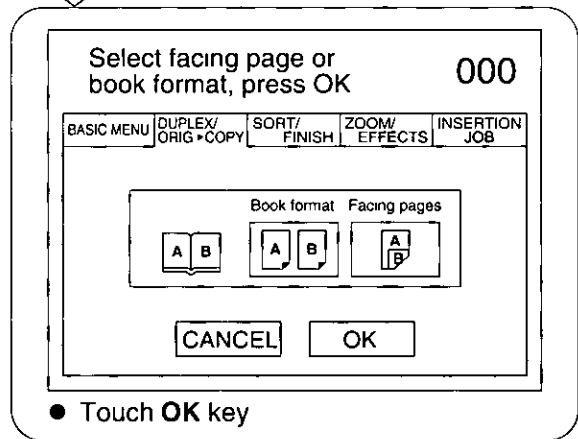
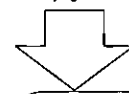

NOTE

- To reset each menu, touch Cancel key
- Press the reset key to feed out last copy existing in the ADU (Automatic Duplex Unit)

Duplex/Original ► Copy

2 in 1 (4 in 1)

■ 2 in 1 Copy

From two 1-sided originals side by side to 1-sided copies.

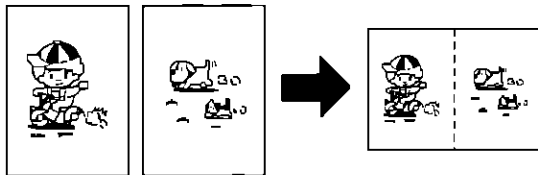

■ 4 in 1 Copy

From four 1-sided originals side by side to 2-sided copies.

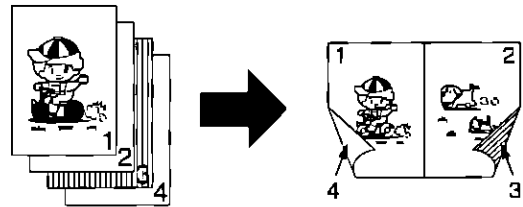

■ Procedure

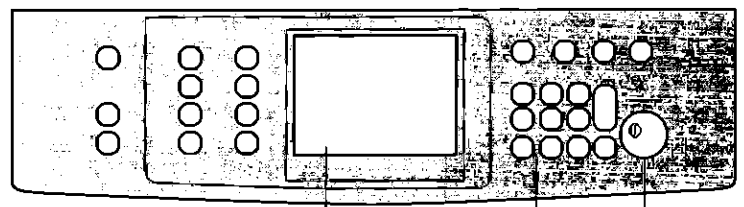
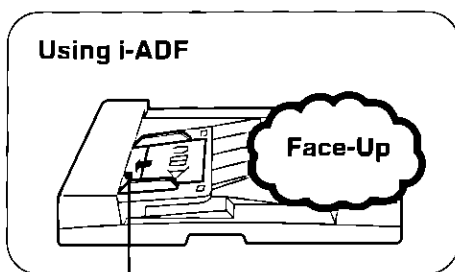

2

Position originals
(Top side down)

3

Count
originals

1

Touch 2 in 1
mode

4

Number of
copies

5

Press
Print

For 4 in 1 Copy

■ 4 in 1 Copy

with combined 2 in 1 and 1 → 2
Copy mode, 4 in 1 Copy is available.

- ① Original counting must be done. (See P.15)
- ② Touch DUPLEX/ORIG. ► COPY key.
- ③ Select 1 → 2 mode.
- ④ Return originals to i-ADF.
- ⑤ Perform steps 4 and 5.

NOTE

- 2 in 1 (4 in 1) Copy can only be made from Letter size originals.
- Press the reset key to feed out last copy existing in the ADU (Automatic Duplex Unit).

Sort/Finish

When touching SORT/FINISH key

Initial Screen

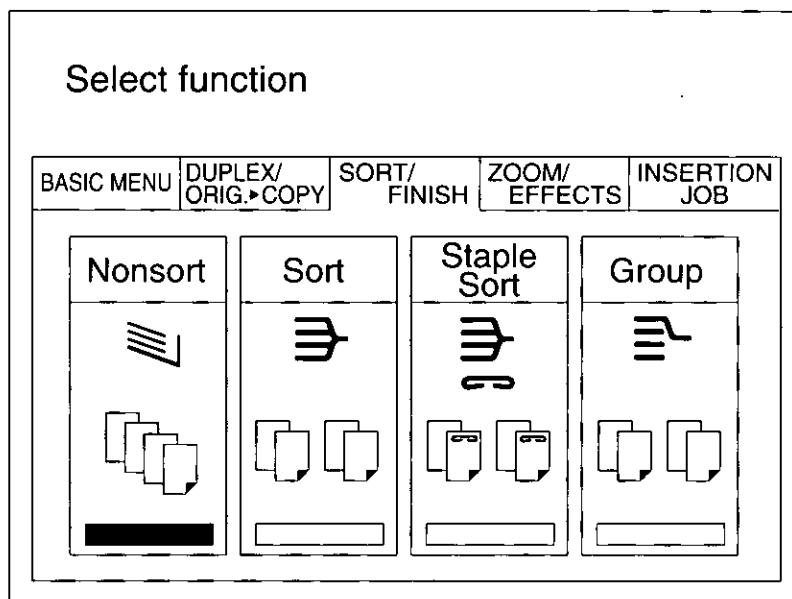

- Touch the desired key to select the function.

Nonsort	All copies are placed in the top bin (stack tray/FA-S680).	
Sort	1 copy of each original is placed into a separate bin.	⇒ See P.20/45
Staple Sort	Sorted copies are stapled automatically. (FA-S680 and i-ADF/ADF)	⇒ See P.20/45
Group	Multiple copies of each original are placed into separate bins.	⇒ See P.20/45

NOTE

- To reset Sort/Finish mode, press Reset key.

Sort/Finish

■ Procedure

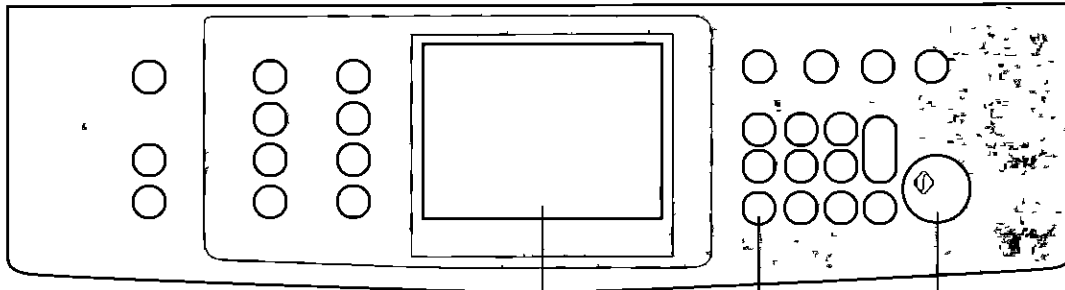

1

Position originals
(Up to 50 sheets)

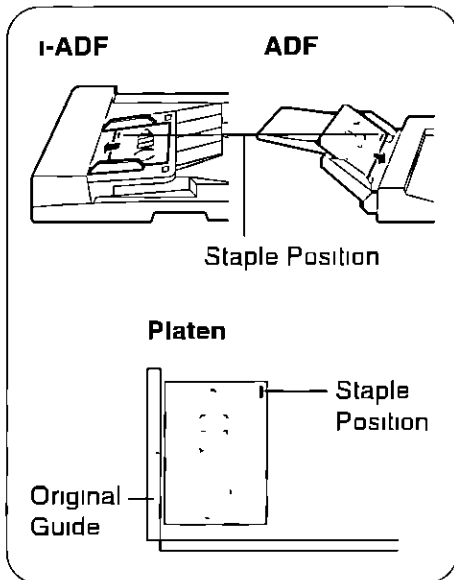
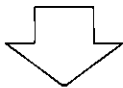

2

Select modes

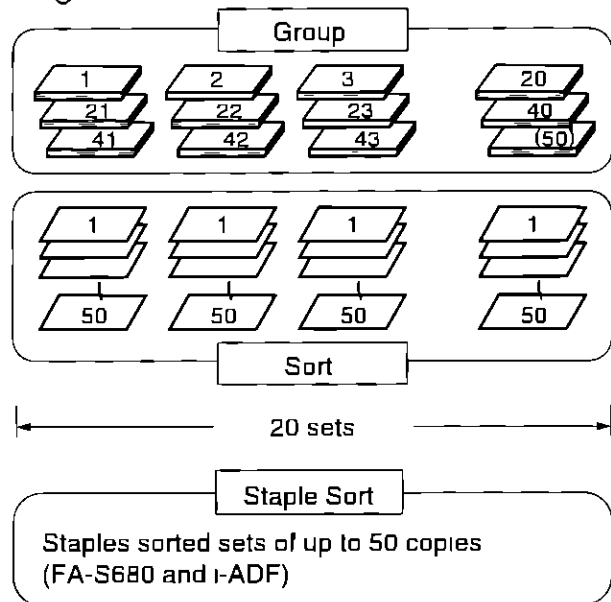
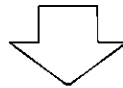

This figure shows 50 letter size (20 lbs) originals and 50 letter size copies

NOTE

- When using platen, the copies will not be stapled automatically, press Manual Staple key after copying is complete



When the overflow **OF** indicator appears on the display, remove excess copies from the bins, then press SORT/FINISH mode key to reset

■ Manual staple copies (FA-S680)

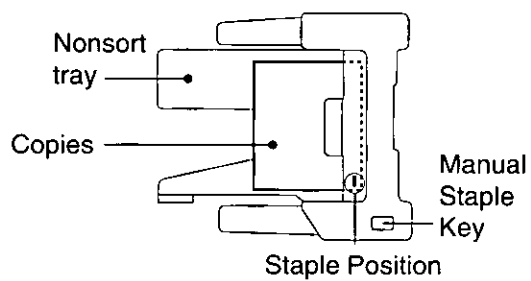

Place copies to be stapled into Nonsort tray of the sorter and press Manual Staple key.

{ Size: Invoice to Ledger.
Number of copies:
Up to 50 sheets, 20 lbs. }

Zoom/Effects

When touching ZOOM/EFFECTS key

■ Initial Screen

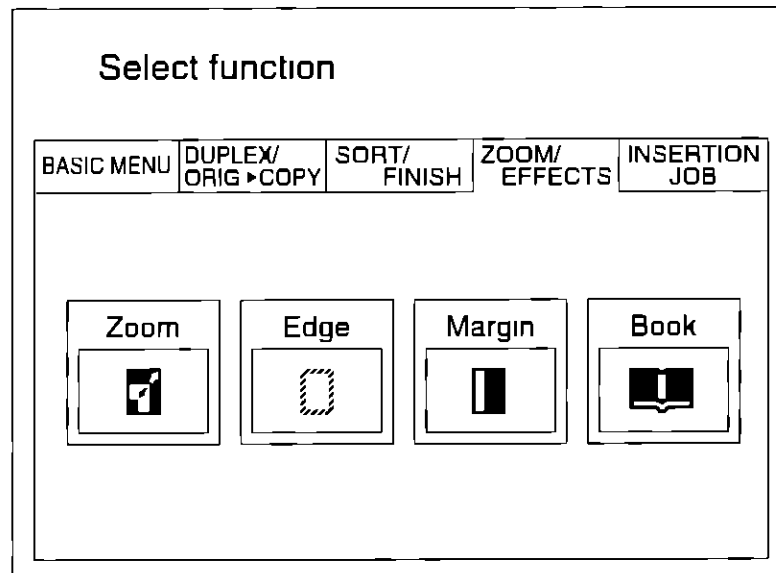

- Touch the desired key to select the function

Zoom	Copies with variable zoom ratios from 50% to 200% in 1% increments	⇒ See P 23
Edge	Creates a blank edge	⇒ See P 24
Margin	Shifts image to right	⇒ See P 24
Book	Eliminates dark inner binding shadows	⇒ See P 24

NOTE

- To reset Zoom/Effects mode, press Reset key

Zoom Copying

■ Procedure

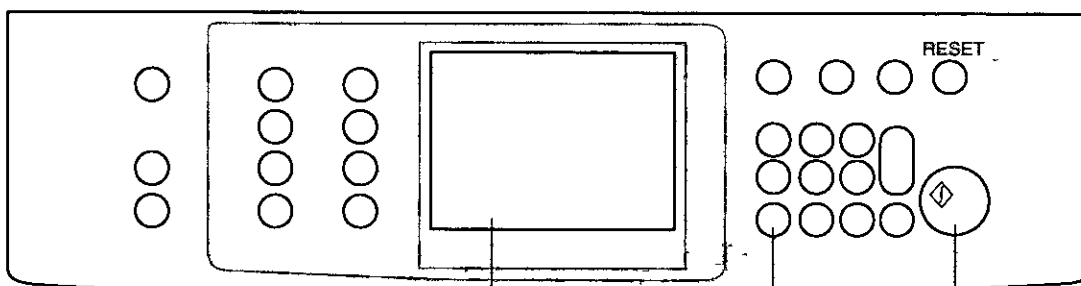

- 1 Position original
- 2 Select zoom ratio
- 3 Select desired paper size
- 4 Number of copies
- 5 Press Print

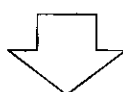

2

Set zoom %
Press OK

1

BASIC MENU | DUPLEX/ ORIG-COPY | SORT/ FINISH | ZOOM/ EFFECTS | INSERTION JOB

77%

CANCEL OK

Zoom Ratio 50% – 200%

- ① Touch **Zoom/Effects** key
- ② Touch Zoom key
- ③ Press and hold the Down or Up key (Increase in 1% increments)

▲ (UP) For enlargement

▼ (DOWN) For reduction

- ④ Touch **OK** key

3

Ready to copy

1

BASIC MENU | DUPLEX/ ORIG-COPY | SORT/ FINISH | ZOOM/ EFFECTS | INSERTION JOB

LETTER 77%

LETTER

2

PHOTO LIGHT AUTO DARK CASSETTE

- ① Touch **Cassette** key
- ② Select the paper tray (paper size), then touch **OK** key

— Paper Tray (CASSETTE) Key

ATTENTION

- If a different paper size is desired, press the Paper Tray (CASSETTE) key
- When Copy Size key is pressed, the ratio will return to preset position

NOTE

- To reset zoom copying, press Reset key
- To reset each mode menu, touch Cancel key on the touch panel

Zoom/Effects

Edge/Margin/Book

Edge Mode

Creates a blank edge.

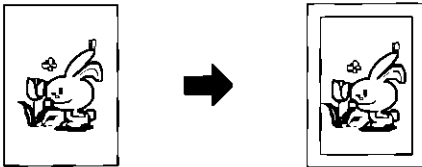

The edge width is initially set at 5 mm. Range can be set from 5.0 mm to 95 mm in 5.0 mm increments.

Margin Shift Mode

Shifts image to right.

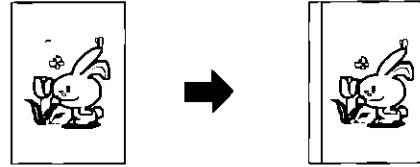

The margin is initially set at 10 mm. Range can be set from 2.5 mm to 97.5 mm in 2.5 mm increments. (See NOTE)

Book Mode

Eliminates dark inner binding shadows.

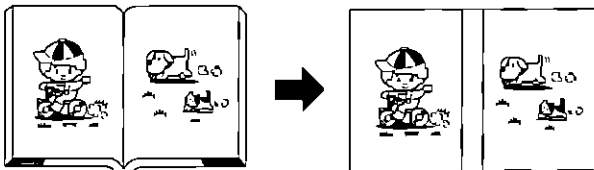

Book mode is initially set at 20 mm. Range can be set from 2.5 mm to 97.5 mm in 2.5 mm increments.

Position of the original

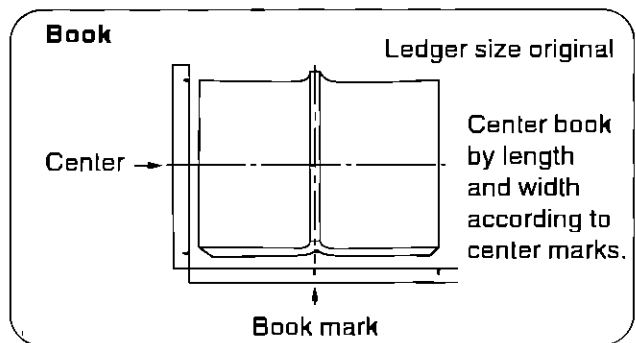
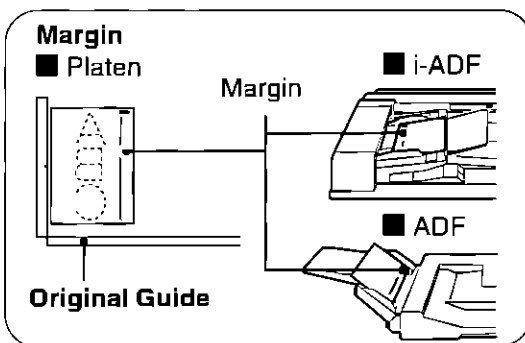

NOTE

- If Margin shift mode cuts off right side of image, use Margin reduction mode (95%, 93% or 91%) to create a margin. (See P.36)
- The Book mode is useful for eliminating dark shadows associated with book or magazine copying.
- In reduction or enlargement copying margin size changes in proportion to copy size.

■ Procedure

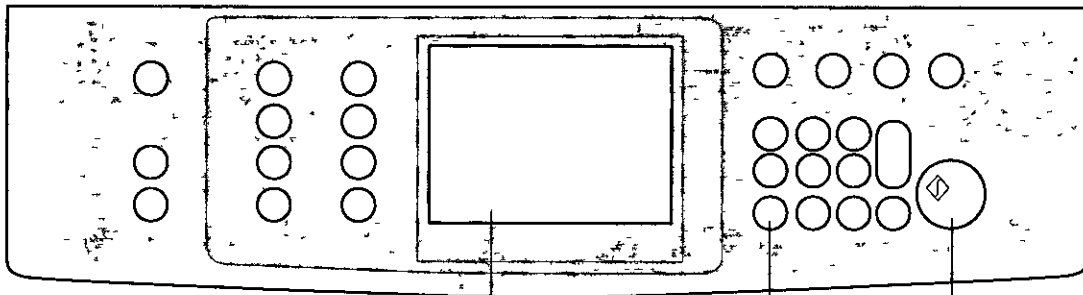

1

Position original

2

Select modes

3

Number of copies

4

Press Print

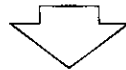

Edge

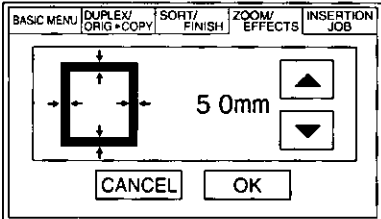

Margin

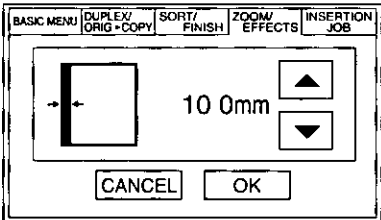

Book

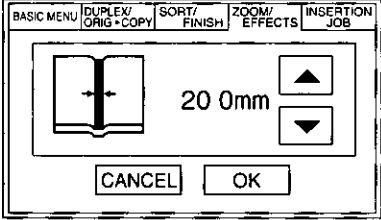

- ① Touch **Edge**, **Margin** or **Book** key
- ② Adjust the width of void area with keys

Initial setting*

Edge mode	5 0 mm
Margin mode	10 0 mm
Book mode	20 0 mm

- ③ Touch **OK** key

NOTE

- To reset each mode, touch Cancel key on the screen
- * To change initial setting of default, see page 36

Insertion Job

When touching INSERTION JOB key

■ Initial Screen

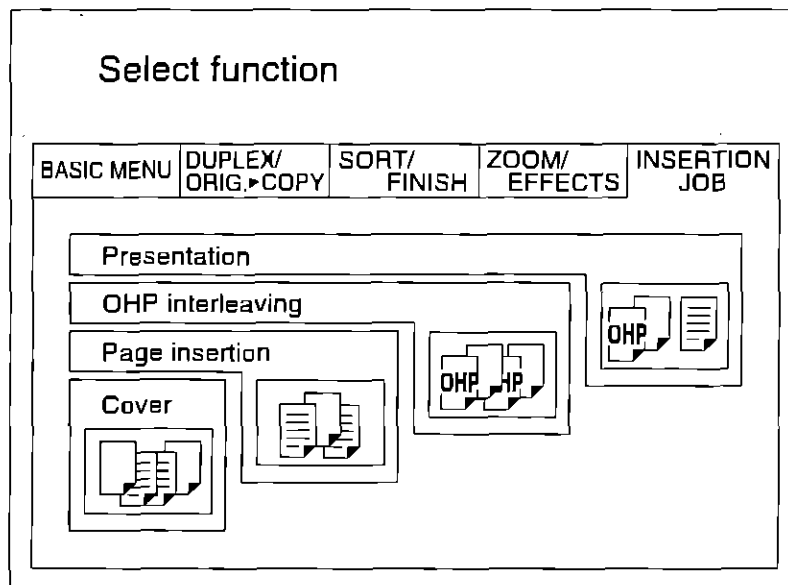

- Touch the desired key to select the function.

Cover	Adds cover page(s) to the copies.	⇒ See P.27
Page insertion	Inserts paper between the copies.	⇒ See P.28
OHP interleaving	Inserts paper between OHP film.	⇒ See P.29
Presentation	Inserts paper between OHP film and make copied sets for hand-outs.	⇒ See P.29

NOTE

- The i-ADF/ADF and Sorter are required for Insertion Job.
- To reset Insertion job, press reset key.

Cover

Features

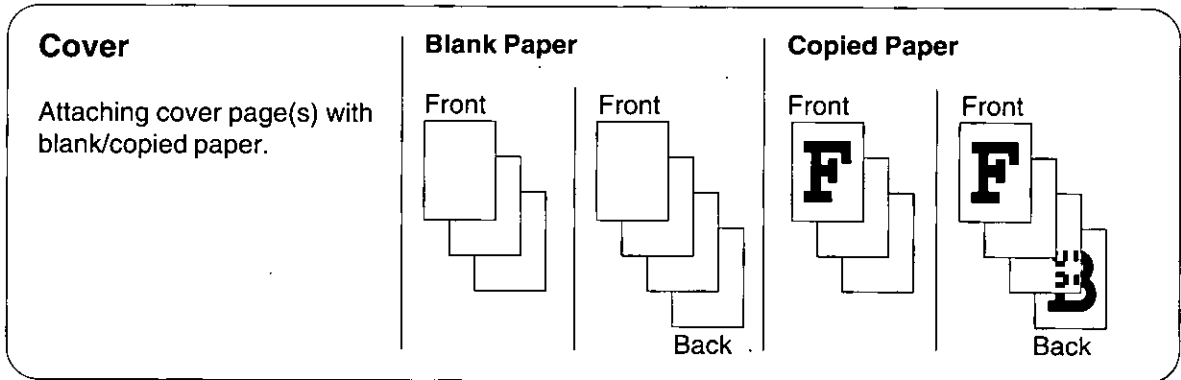

Operation

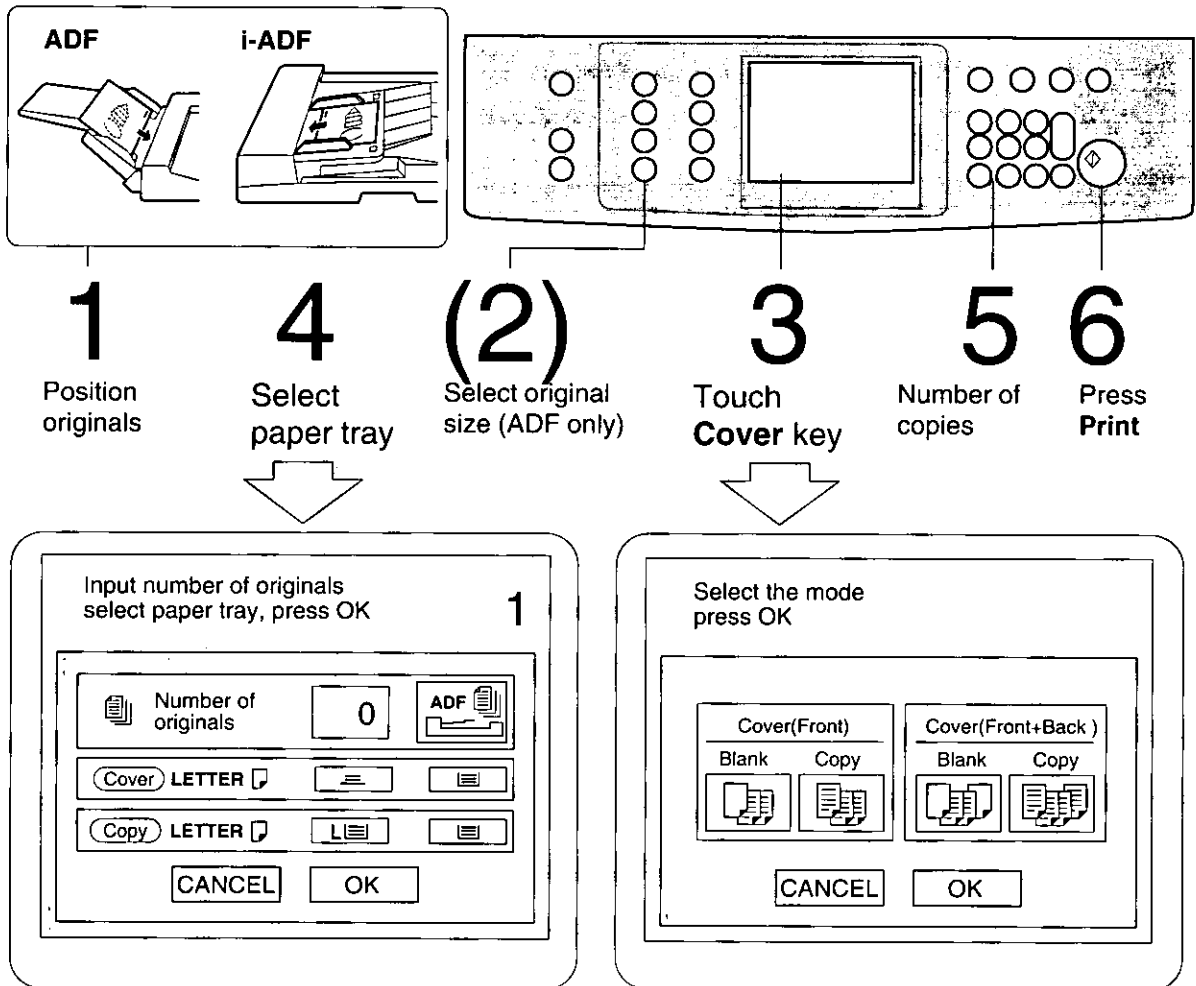

NOTE

- If number of originals is unknown, touch Original Count key. **ADF** (See P.15)
- To reset each mode menu, touch Cancel key.

Insertion Job

Page insertion

Feature

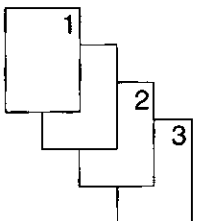
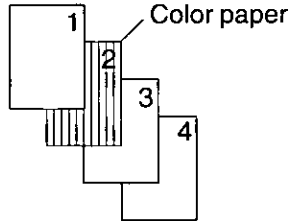
<p>Page insertion</p> <p>Inserting paper between the copies</p> <p>(Blank paper, colored paper or copied paper)</p>	<p>Blank Paper</p> 	<p>Copied Paper</p> 
--	---	--

Operation

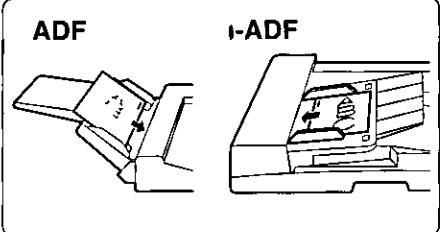

1
Position originals

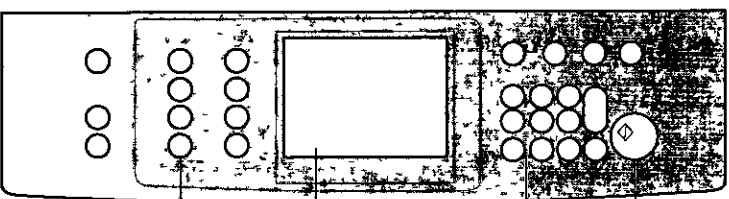

4
Select original size (ADF)

(2)

3
Touch **Page insertion** key

5
Number of copies

6
Press **Print**

• Input number of Originals* and Select Paper tray then press OK (See P 27)

Input the position of insert press OK

Sheet placement				
3	6	11	15	29
31	38	47		

◀
CANCEL
OK
▶

Select the mode, **Blank** or **Copy**, then press OK
Color paper is suitable for copy mode

- ① Input the interleaving position with Quantity keys
- ② If you input more than 2 places, move the input position with key (◀/▶)
- ③ Repeat ① and ②
- ④ Touch OK key

NOTE

- If the old interleaving position(s) is/are left, cancel the old data with key (◀/▶ and Clear/Stop key)
- To reset each mode menu, touch Cancel key on the touch panel
- * If number of originals is unknown, touch Original Count key (See P 15)

OHP interleaving/Presentation

Feature

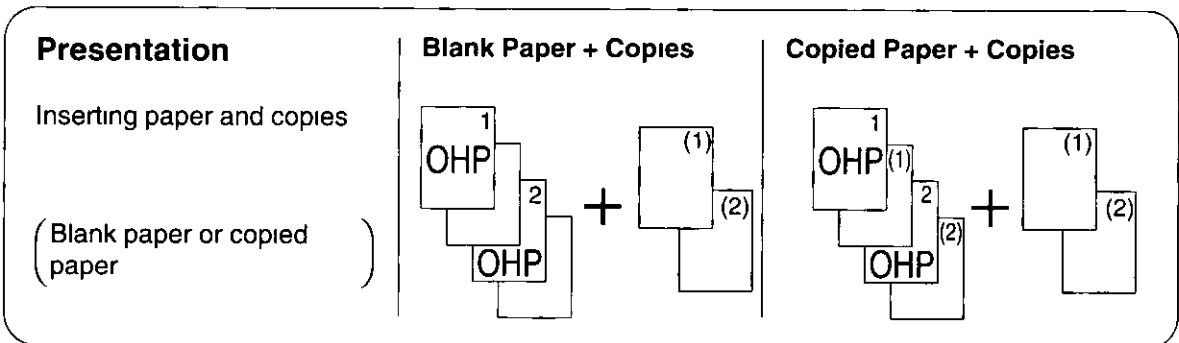
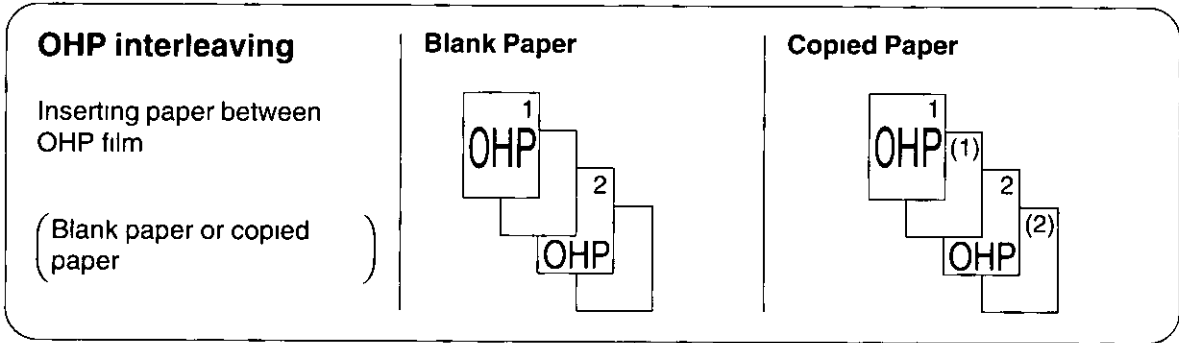

Operation

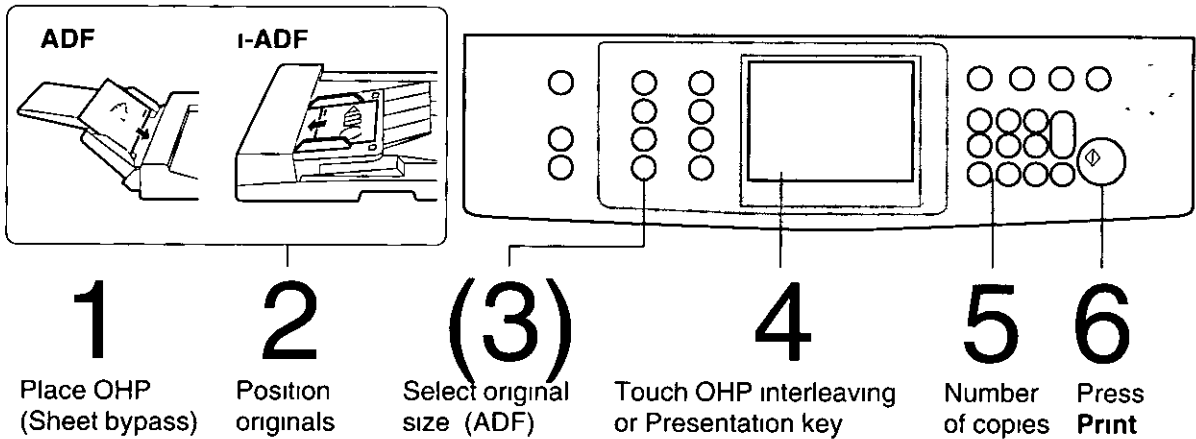

① Select the mode, **Blank** or **Copy**, then touch OK
 ② Select the paper tray *

NOTE

* Selection of the paper tray (ex Presentation mode)
 Select the paper tray for page insertion and copy, then touch OK key

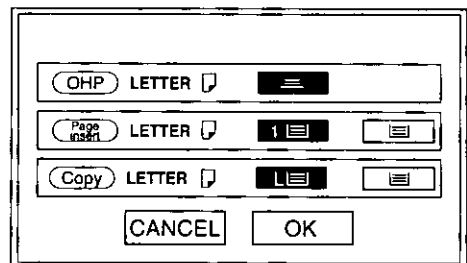

Programming Copy Jobs

- Five copy jobs can be programmed in memory (M1 to M5) for recall at a later time.

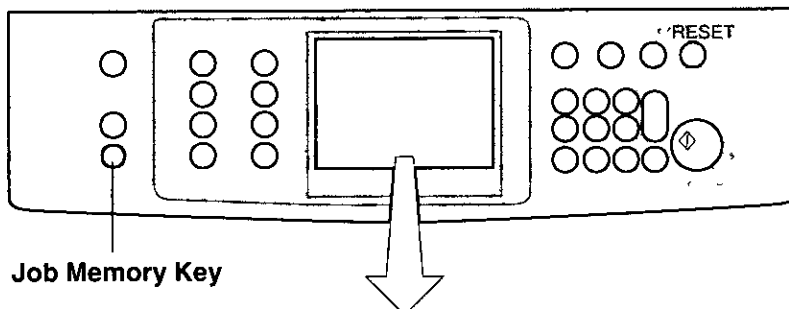

Job Memory Key

To store a job in memory

- ① Set up the copy job to be stored in memory
- ② Press Job Memory key
- ③ Touch **Memory In** key (MIN)
- ④ Touch **M1**, **M2**, **M3**, **M4** or **M5** key

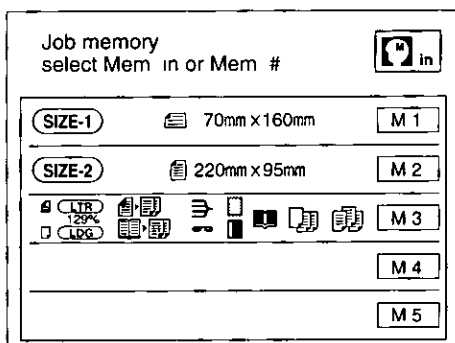

To recall a job stored in memory

- ① Press Job Memory key
- ② Touch **M1**, **M2**, **M3**, **M4** or **M5** key
- ③ Press **Print**

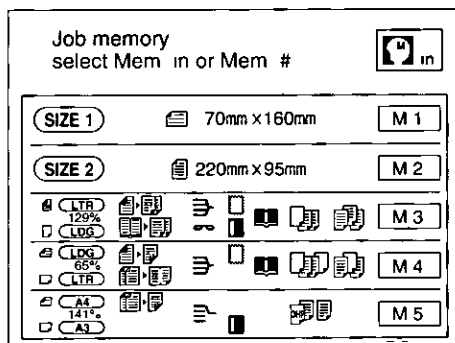

NOTE

- Job memory mode will not be deleted even if power switch is turned off
- When storing a new job, the previously stored job will automatically be deleted and the current job stored in its place
- To reset Programming job, press reset key

Skyshot Mode

■ By setting the check size (or other original smaller than letter size) in the user preset mode, copying from small originals is possible without dark areas around the image.

- Setting of Skyshot mode by key operator (See P 37, 39)
 - ① No 1 of 3/4 screen Select Skyshot mode function
 - ② No 5 of 4/4 screen Input key operator's code number
 - ③ No 3 of 3/3 screen Input a size (M1)
 - ④ No 4 of 3/3 screen Input another size (M2) if necessary

Above sizes must be memorized in M1 and M2

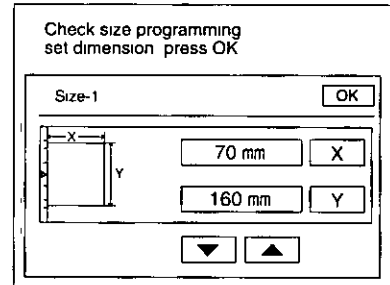

■ Operation

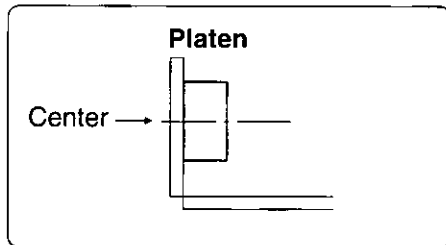

1

Position original

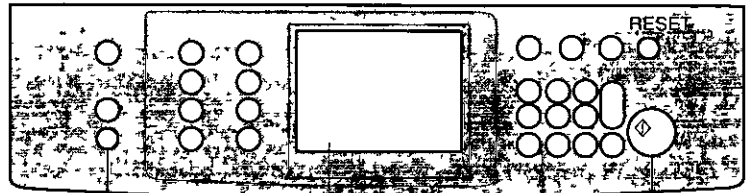

2

Press Job Memory key

3

Select M1 or M2

4

Number of copies

5

Press Print

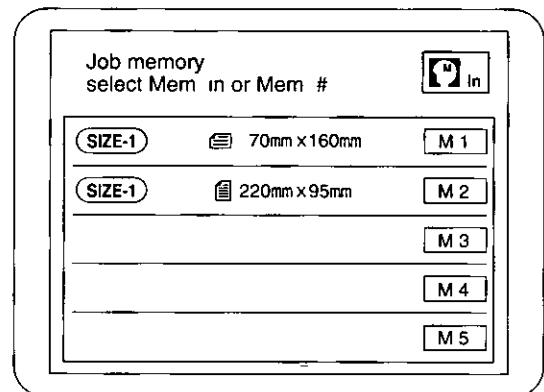
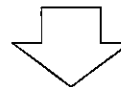

NOTE

- If changing the sizes in memory, perform above steps ② to ④
- To reset Skyshot mode, press Reset key

Energy Saver/Interrupt

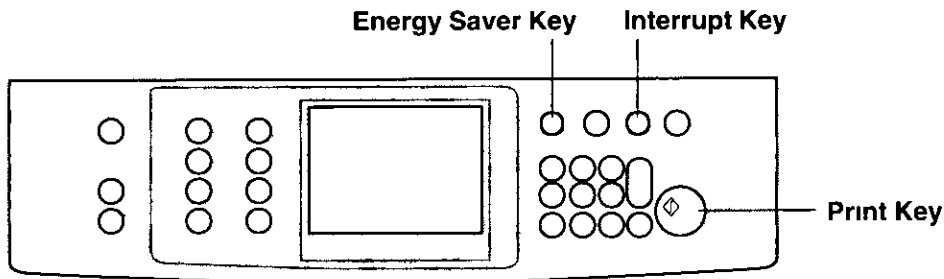

- These modes can save power while the copier is not in use

Energy Saver Mode

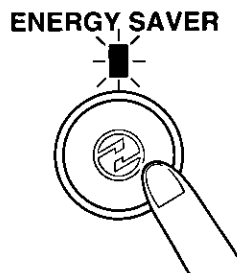

- ① To enter this mode
Press Energy Saver key or automatically enter after 15 minutes from the last copy. The indicator will flash.
- ② To cancel this mode and make copies, press Energy Saver key again.

Auto Off Mode

- ① Automatically enters after 60 minutes (or 90 minutes/FP-7750) from the last copy. Copier power will drop and the indicator will light.
- ② To make copies, press Energy Saver key.

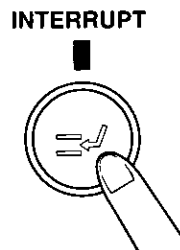

Interrupt Mode

- This mode can interrupt other copy jobs while making copies
- ① Touch **Interrupt** key, then indicator will light.
 - ② Make other copy job.
 - ③ Touch **Interrupt** key again to continue original job.

NOTE

- Energy saver time (15 minutes) and Auto off time (60 or 90 minutes) can be changed by key operator (See P 38, 41)

Changing Paper Size

Paper Drawer/Tray (Copier Main Unit)

- The paper drawer/trays are designed to accommodate invoice, letter, legal and ledger size paper. To change the paper size, consult your service technician for proper instructions.

Perform following steps as shown below after any locking screws have been removed.

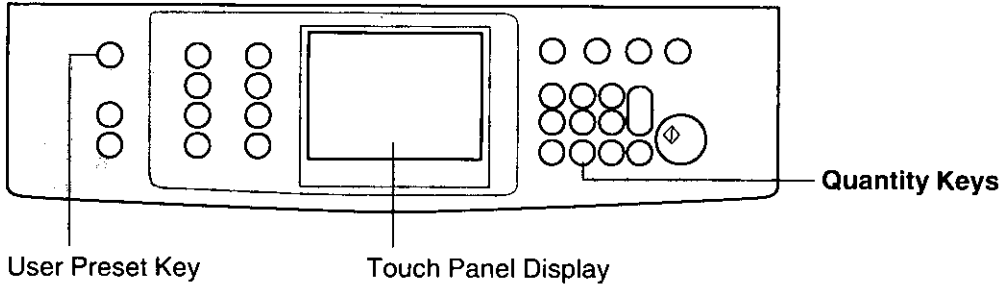

1 Press User Preset Key.

2 Touch Paper size (1) Key.

The screenshot shows a menu titled "User preset mode select item" with an "OK" button in the top right. The menu items are:

- 1 Paper size
- 2 Paper size priority Letter
- 3 Margin value default 10 mm
- 4 Edge value default 5 mm
- 5 Book value default 20 mm

 At the bottom, there are navigation arrows and a page indicator "1/4". A hand is shown touching the "1 Paper size" option.

3 Touch a paper drawer required.

Paper size is changed* by touching the key until the required size appears.

The screenshot shows a menu titled "Select paper tray press OK". On the left, there are five paper tray icons labeled 1 through 5. On the right, there are five paper size options:

- 1
- 2 INVOICE
- 3 LEGAL
- 4 LEDGER
- 5 LETTER

 An "OK" button is in the bottom right. A hand is shown touching the "2 INVOICE" option.

NOTE

• Automatic Duplex Unit (ADU) is installed in the first (1) drawer.

* Paper size is changing as follows.

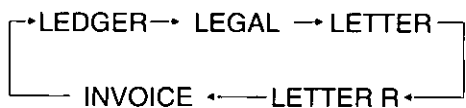

Energy Saver/Interrupt Changing Paper Size

Change Paper Size

4

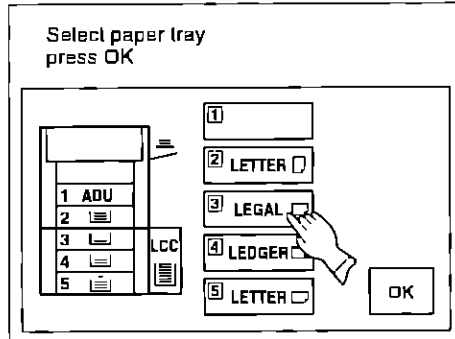

Repeat, if necessary, to set another paper drawer

After setting all paper drawers, touch OK key to return to the initial User Preset screen

5

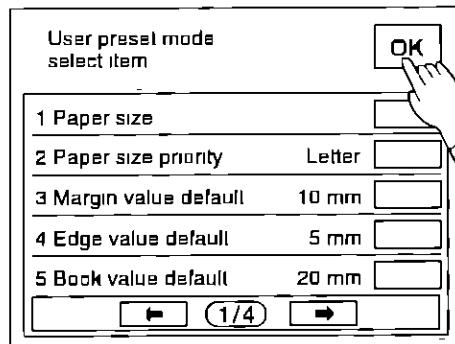

Touch OK key to return to the Basic Menu screen

6

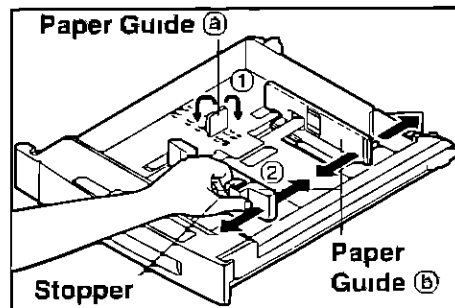

- ① Adjust paper guide (a) to the paper length
- ② Adjust paper guide (b) to the paper width

Squeeze the stopper to move the paper guide (b) to the desired paper size

7

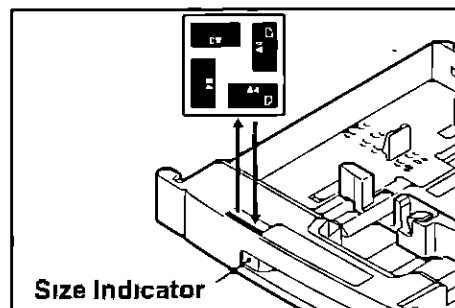

Change the paper size indicator

Take out and re-insert the indicator so the correct paper size is shown (Invoice size is on the back side)

NOTE

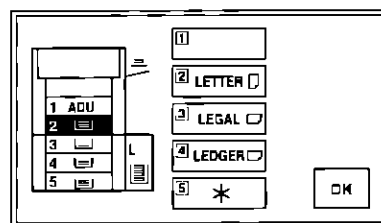

* If the paper drawer is not installed or is not inserted completely, the paper size indication will not appear (ex 5th tray)

Combining Function Table

Later Selections \ First Selections		DUPLEX/ ORIG ► COPY						SORT/ FINISH				INSERTION JOB				ZOOM/ EFFECTS				
		1 → 2	2 → 1	2 → 2	Book → 2	2 Page	2 in 1	Nonsort	Sort	Staple Sort	Group	Cover	Page Insertion	OHP Interleaving	Presentation	Zoom	Edge	Margin	Book	Interrupt
DUPLEX/ ORIG ► COPY	1 → 2	A	A	A	X	O	O	O	O	O	O	O	O	A	A	O	O	O	O	A
	2 → 1	A	A	A	A	A	O	O	O	O	O	O	O	O	O	O	O	O	O	A
	2 → 2	A	A	A	X	X	O	O	O	O	O	O	A	A	O	O	O	O	O	A
	Book → 2	A	A	A	X	X	O	O	O	O	A	A	A	A	O	O	O	O	O	A
	2 Page	A	A	A	A	A	O	O	O	O	A	A	O	O	O	O	O	O	O	A
	2 in 1	O	A	A	A	A	O	O	O	O	O	O	A	A	O	O	O	O	O	A
SORT/ FINISH	Nonsort	O	O	O	O	O	A	A	A	A	A	O	A	O	O	O	O	O	O	
	Sort	O	O	O	O	O	A	A	A	O	O	A	O	O	O	O	O	O	A	
	Staple Sort	O	O	O	O	O	A	A	A	O	O	A	O	O	O	O	O	O	A	
	Group	O	O	O	O	O	A	A	A	A	A	A	A	O	O	O	O	O	A	
INSERTION JOB	Cover	O	O	O	X	X	O	X	O	X	O	A	A	O	O	O	O	O	A	
	Page Insertion	O	O	O	X	X	O	X	O	X	O	A	A	O	O	O	O	O	A	
	OHP Interleaving	X	O	X	X	O	X	X	X	X	A	A	A	O	O	O	O	O	A	
	Presentation	X	O	X	X	O	X	O	O	X	A	A	A	O	O	O	O	O	A	
ZOOM/ FINISH	Zoom	O	O	O	O	O	O	O	O	O	O	O	O	O	O	O	O	O	A	
	Edge	O	O	O	O	O	O	O	O	O	O	O	O	O	O	O	O	O	A	
	Margin	O	O	O	O	O	O	O	O	O	O	O	O	O	O	O	O	O	A	
	Book	O	O	O	O	O	O	O	O	O	O	O	O	O	O	O	O	O	A	
Interrupt		X	X	X	X	O	X	X	X	X	X	X	X	X	O	O	O	O	*	

- Combination use possible
- × Combination use not accepted
- A No combination use possible (Last selection takes priority)

NOTE

* When pressing Interrupt key twice, interrupt mode is cancelled

Change Paper Size
Combining Function Table

User Preset

- User Preset modes can change the initial copy mode, if necessary.
(See P.40, 41)

User preset mode select item		OK
1 Paper size		
2 Paper size priority	Letter	
3 Margin value default	10 mm	
4 Edge value default	5 mm	
5 Book value default	20 mm	
← (1/4) →		

User preset mode select item		OK
1 Margin reduction default	100%	
2 Sorter mode default	Nonsort	
3 Duplex mode default	1 → 2	
4 2 in 1 default	Reduc.	
5 Auto edge default	ON	
← (2/4) →		

Screen No.	Modes	Function	Initial Setting
1/4	1. Paper size	Sets the paper size of each paper drawer (Ledger, Legal, Letter, Letter R or Invoice size).	See P.33
	2. Paper size priority	Specifies the paper size of most frequent usage.	Letter
	3. Margin value default	Selects the margin shift value (5 mm, 10 mm, 15 mm or 20 mm).	10 mm
	4. Edge value default	Selects the edge width (5 mm, 10 mm, 15 mm or 20 mm).	5 mm
	5. Book value default	Selects the book void width (15 mm, 20 mm, 25 mm or 30 mm).	20 mm
2/4	1. Margin reduction default	Selects the reduction ratio in margin mode (95%, 93%, 91% or 100%).	100%
	2. Sorter mode default	Determines the most frequent usage mode (non sort, sort, staple sort or group).	Nonsort
	3. Duplex mode default	Determines most frequent usage mode, (1 → 2, 2 → 2, book → 2 or No).	1 → 2/7750 No/7742
	4. 2 in 1 Copy ratio	Selects whether to copy full size or reduction in the 2 in 1 mode.	Reduction
	5. Auto Edge default	Selects whether or not to disable Auto Edge Deletion*.	ON

NOTE

* Auto Edge Deletion

To copy from the platen with the original cover or i-ADF open. Normally, this makes a copy with a solid (black) area around the original if the original is smaller than the copy paper. This mode eliminates the solid area automatically.

- Item numbers (1, 2, 3, 4, 5) and (Reserved) are not indicated on the display.

User preset mode
select item OK

1 Skyshot mode default	OFF	<input type="checkbox"/>
2 Manual add toner	OFF	<input type="checkbox"/>
3 Departmental counter		<input type="checkbox"/>
4		<input type="checkbox"/>
5		<input type="checkbox"/>

← (3/4) →

User preset mode
select item OK

1		<input type="checkbox"/>
2		<input type="checkbox"/>
3		<input type="checkbox"/>
4		<input type="checkbox"/>
5 Set key operator code		<input type="checkbox"/>

← (4/4) →

Screen No	Modes	Function	Initial Setting
3/4	1 Skyshot mode default	Enables or disables the use of skyshot mode	OFF
	2 Manual add toner	Allows the addition of toner as determined by the operator Select ON, and touch OK on the screen	OFF
	3 Departmental counter	Monitors copy usage of each department (1) Total copy usage of all departments (2) Total copy usage of a specified department (Up to 100 departments) (3) Total copy limit of a specified department (NOTE) Above items (2) and (3) are required to input the department code number	
	4 Reserved		
	5 Reserved		
4/4	1 Reserved		
	2 Reserved		
	3 Reserved		
	4 Reserved		
	5 Set key operator code	Inputs key operator code number	

User Preset

■ User Preset modes for Key operator.

User preset mode select item		OK
1 Auto reset time	1 min	<input type="text"/>
2 Energy saver time	15 min	<input type="text"/>
3 Auto off time	60 min	<input type="text"/>
4 Exposure default	Manual	<input type="text"/>
5 Language default	English	<input type="text"/>
<input type="button" value="←"/> (1/3) <input type="button" value="→"/>		

User preset mode select item		OK
1 Special Paper Tray 1	None	<input type="text"/>
2 Special Paper Tray 1	None	<input type="text"/>
3 Interleaving default	Blank	<input type="text"/>
4 Page insertion default	Blank	<input type="text"/>
5 Cover mode default	F, blank	<input type="text"/>
<input type="button" value="←"/> (2/3) <input type="button" value="→"/>		

Screen No	Modes	Function	Initial Setting
1/3	1 Auto reset time	Selects the reset time (45 seconds, 1 minute, 2 minutes or None)	1 minute
	2 Energy saver time	Selects the Energy saver time (15/30/60 minutes, 1 5/2/3/4 hours)	15 minutes
	3 Auto off time	Selects the Auto off time (No, 30/60 minutes, 1 5/3/4 hours)	60 minutes or 1 5 hours (FP-7750)
	4 Exposure default	Determines whether to use Auto Exposure (Auto, Manual, or No)	Manual
	5 Language default	Selects the message language of the display (English, German, French, Italian, Spanish, Swedish, Finnish, Dutch, Portuguese)	English
2/3	1 Special paper tray 1	Sets the paper drawer for special (color) paper	None
	2 Special paper tray 2	Sets another paper drawer for special (color) paper	None
	3 Interleaving default	Selects OHP Interleaving paper (blank or copied)	Blank
	4 Page insertion default	Selects Page Insertion (blank or copied)	Blank
	5 Cover mode default	Selects Cover paper (blank or copied) (F, blank/F, copy/FB, blank/FB, copy) F Front, FB Front and back	F, blank

ATTENTION

- The Screens from 1/3 to 3/3 are only available after inputting Key Operator's code number
- Item numbers (1, 2, 3, 4, 5) and (Reserved) are not indicated on the display

User preset mode select item		OK
1		<input type="checkbox"/>
2 Maximum copy setting	OFF	<input type="checkbox"/>
3 M1, Check size	160×70	<input type="checkbox"/>
4 M2, Check size	220×95	<input type="checkbox"/>
5 Dept. counter mode		<input type="checkbox"/>
<input type="button" value="←"/> 3/3 <input type="button" value="→"/>		

Screen No.	Modes	Function	Initial Setting
3/3	1. Reserved		
	2. Maximum copy setting	Determines whether to limit number of copies (1~99) or not.	OFF
	3. M1, Check size	Inputs a size in memory 1 for frequent usage size.	160 × 70 mm
	4. M2, Check size	Inputs another size in memory 2 for frequent usage.	220 × 95 mm
	5. Dept. counter mode	Checks or changes all or specified departments for copy usage, copy limit and code numbers.	

User Preset

■ User Access (1/4 to 4/4 screen)

Example when changing the duplex mode default to 2 → 2 copy

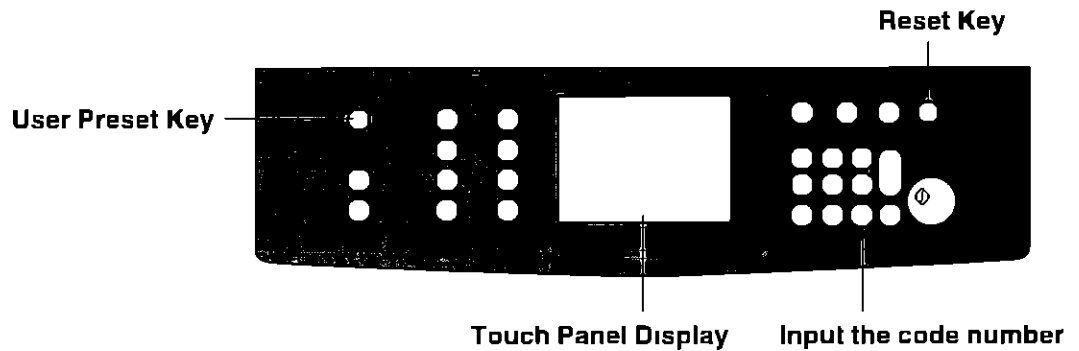

1 Press User Preset key

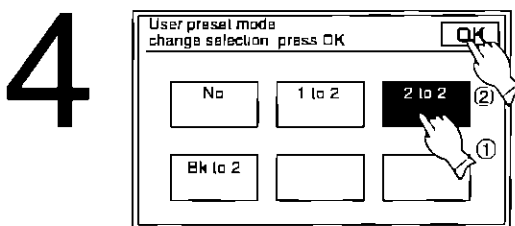
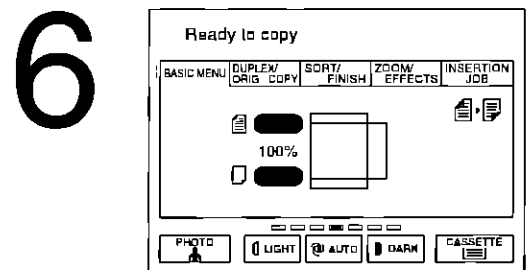
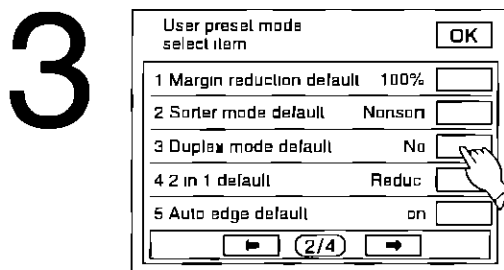
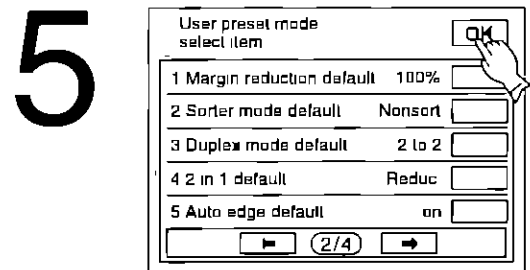
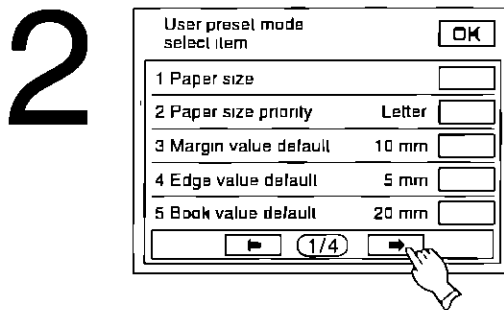

NOTE

- Use [Left] key to step back by one screen at a time
- To reset the user preset mode, press Reset key

■ Key Operator Access (1/3 to 3/3 screen)

Example: when changing the auto off time to 4 hours.

1

Press User Preset key.

2

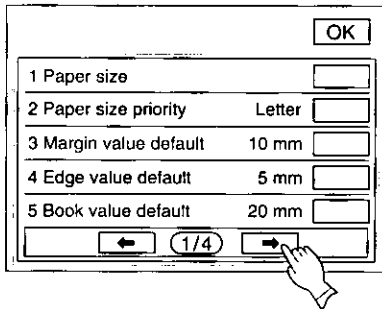

6

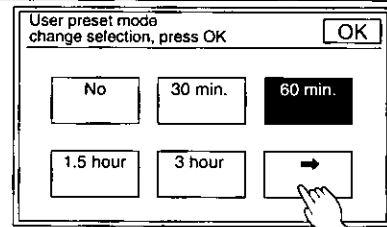

3

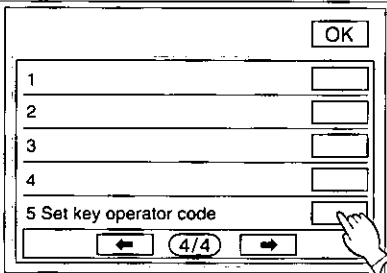

7

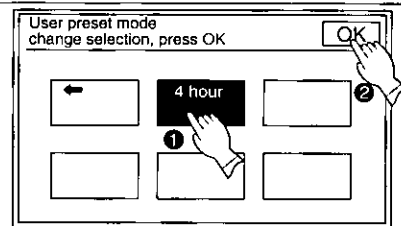

4

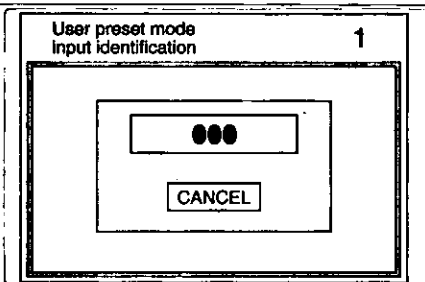

8

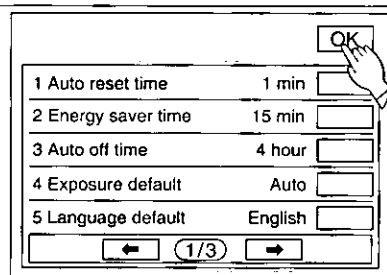

5

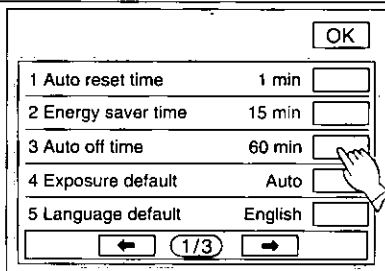

9

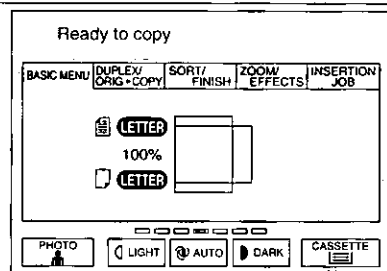

NOTE

- Input the key operator's code number to No.5 of 4/4 screen first, in order to see key operator access screens 1/3 ~ 3/3.

Options

■ Components

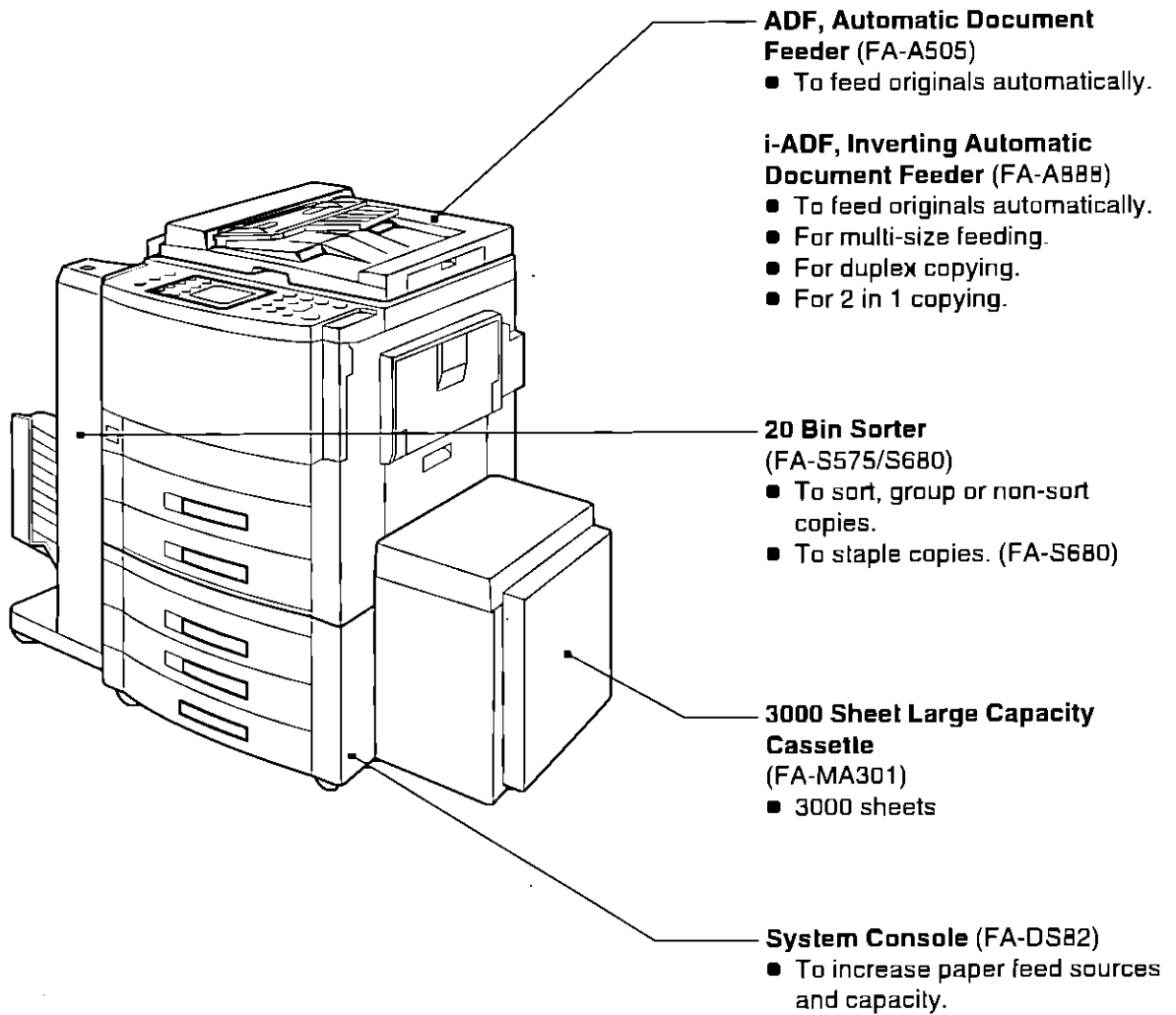

■ System Console (FA-DS82)

Paper Drawer × 1

(550 sheets)

Storage Drawer × 1

Option for system console

Paper Drawer (FA-MA505)

- 550 sheets

The paper drawer/tray is designed to accommodate invoice, letter, letter R, legal and ledger size paper. To change the paper size, see page 33.

i-ADF (FA-A888), ADF (FA-A505)

1 Features

- ① Automatic original feeding
 - The i-ADF/ADF tray can hold up to 50 originals of 20 lbs paper (30 originals/legal, ledger)
 - It can accommodate originals from invoice to ledger size
 - Automatic original size detection
- ② Duplexing (FA-A888)

The i-ADF allows you to perform two different types of duplexing automatically (See P 15–17)
- ③ Multi-size feeding (FA-A888)

Different size originals to be copied full size (1 1) or same size

Originals	Copies		
	Full size	Reduction	Enlargement
Legal Letter R	Legal Letter R	Letter R/Invoice Letter R/Invoice	Ledger Ledger
Ledger Letter	Ledger Letter	Letter R Letter	—

- ④ 2 1 Copy (FA-A888)

2-sided original to 1-sided copies (See P 15)
- ⑤ 2 in 1 copy (FA-A888)

To make a 1-sided copy (full size or reduction), from two 1-sided originals side-by-side (See P 18)

2 Components

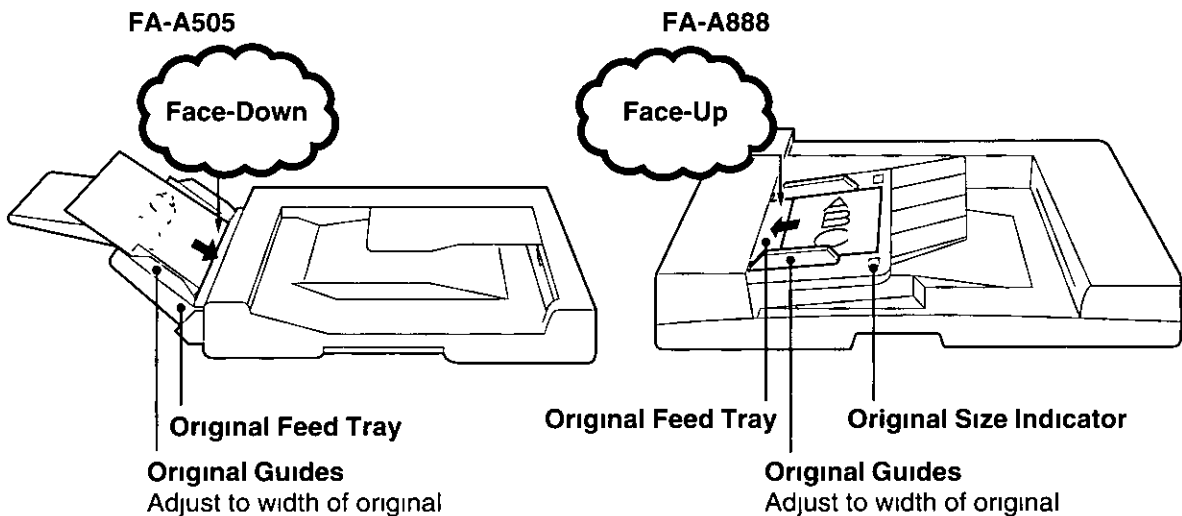

Options

i-ADF (FA-A888), ADF (FA-A505)

3. Usage

■ Procedure

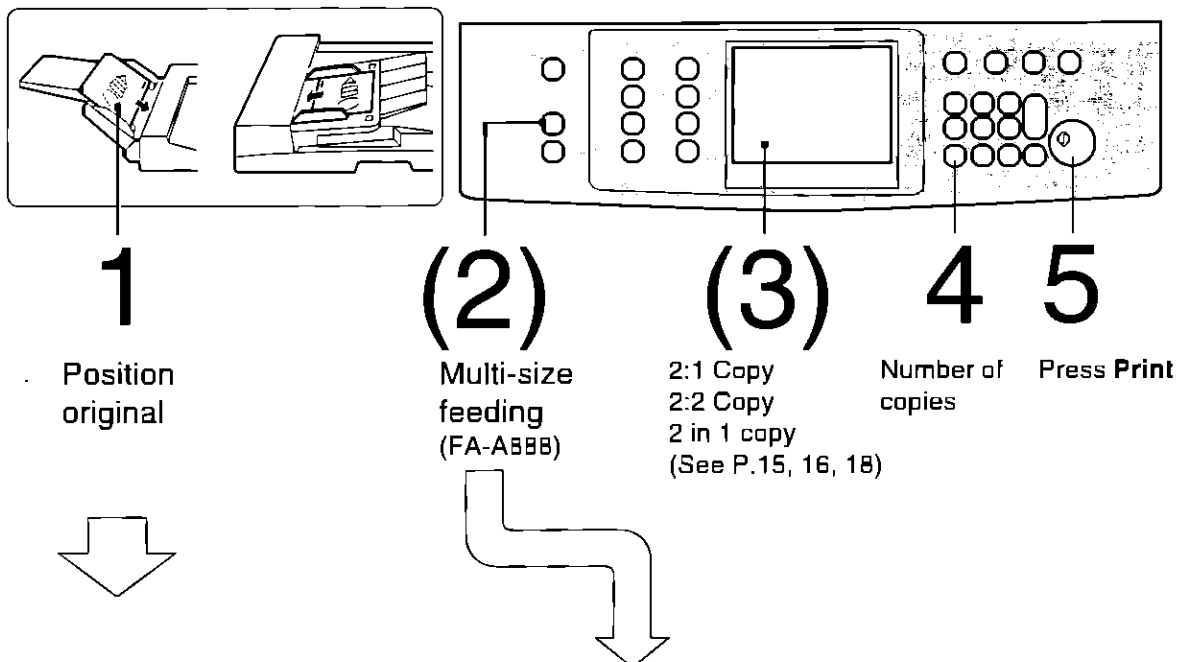

Inappropriate originals

- Paper with a smooth surface such as glossy and coated papers
- Transparencies
- Paste-ups
- Originals with a lead edge that is "creased", "folded", "punched" or "glued"
- Pressure sensitive or carbon backed papers
- Paper with excessive curl
- Stapled originals

■ Press the Multi-Size Feed key.

Different size originals to be copied full size (1:1) or same size.

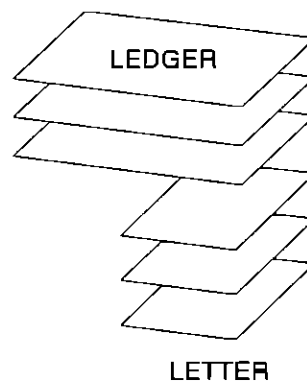

NOTE

- If you use the multi-size feed function on the i-ADF, make sure that the correct size paper is loaded in the copier before placing originals into the i-ADF.

Sorter (FA-S575/S680)

1. Features

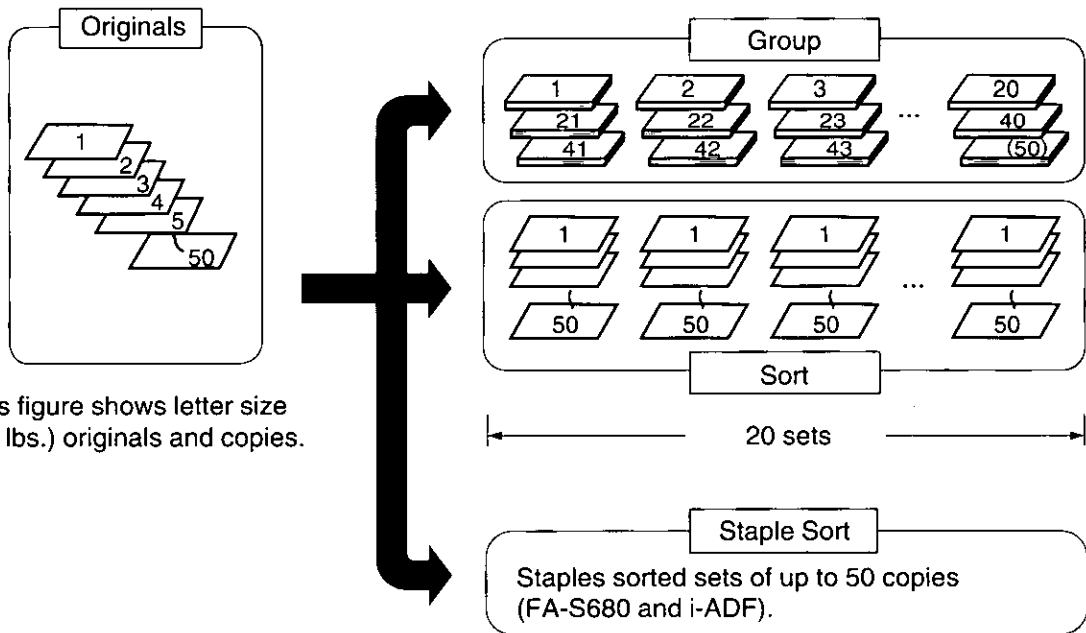

2. Components

(FA-S575)

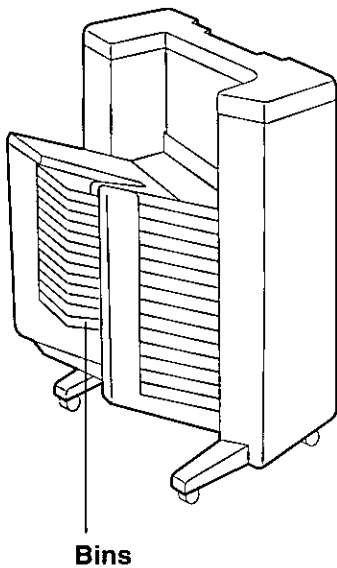

(FA-S680)

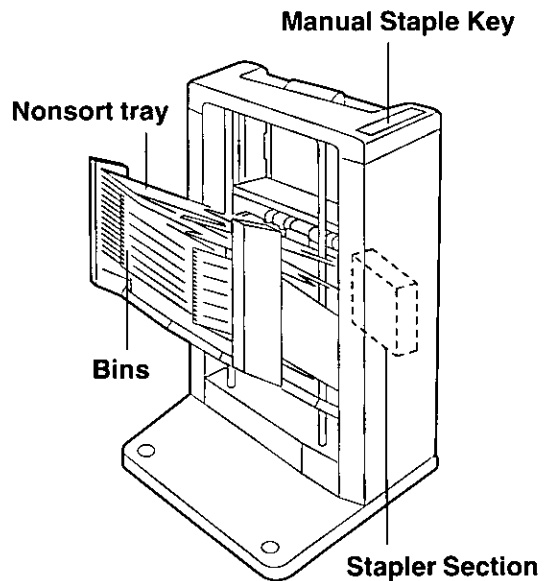

NOTE

oF

When the overflow **oF** indicator appears on the display, remove excess copies from the bins, then press Mode Select key to reset.

- If paper misfeeds or irregular paper alignment occurs in the sorter, turn the paper in the drawer upside down or replace with a new package of paper.

Options

FA-S680

3. Adding staples.

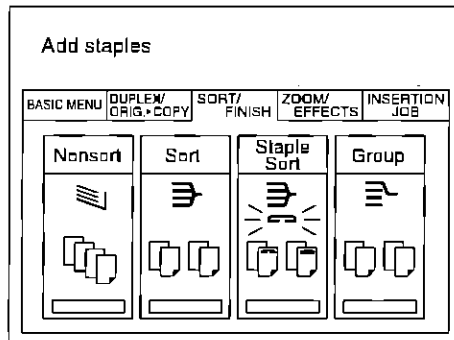

When the staple cartridge is empty, indicator flashes. ()

1

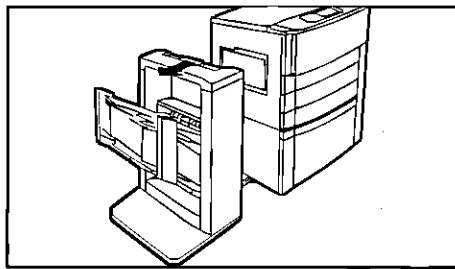

Pull sorter towards the left slowly until it stops.

2

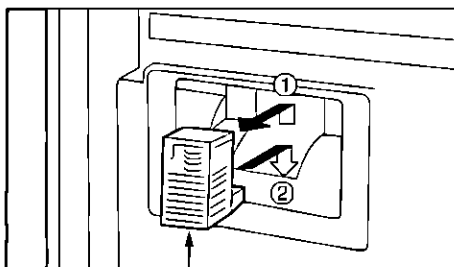

- ① Take out empty staple cartridge.
- ② Install the new cartridge.
Do not touch or move the staples.
- ③ Re-insert sorter.
Message and indicator will disappear.

Staple Cartridge

3

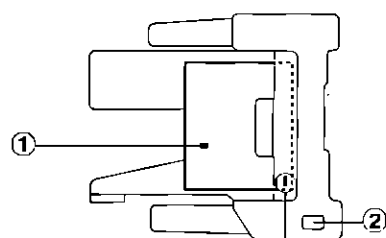

Check operations.

- ① Place some paper on the nonsort tray.
- ② Press the Manual Staple key several times until it staples.

Staple Position

NOTE

- Order staple cartridges through your servicing dealer.
- When staples are jammed, call service.

Adding Paper ()

550 Sheet Paper Drawer/Tray

1

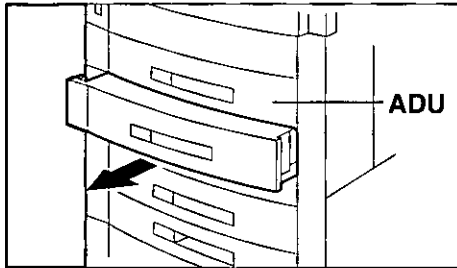

Pull paper drawer/tray out of copier.

Do not load ADU with paper.

2

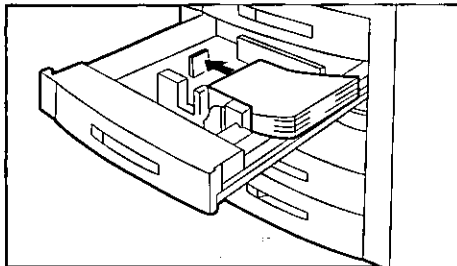

Place paper into paper drawer/tray.

Special papers, like glossy paper, mailing labels and transparencies cannot be used in the paper drawer/tray. Use bypass.

3

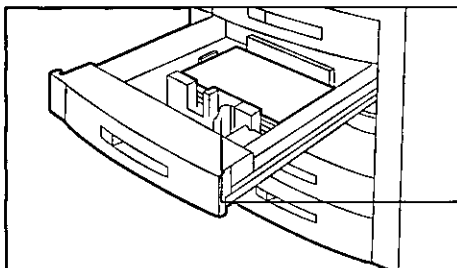

Make sure paper is not loaded above overfill indicator located in the paper drawer/tray.

Overfill Indicator

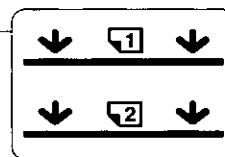

← Up to 550 sheets, 20 lbs.

4

Push paper drawer/tray back into copier.

ATTENTION

- When the staple sorter is used:
Some paper may not be suitable for stapling. Please consult your service technician if you are unsure about the type of paper you are using.

NOTE

- The paper drawer/trays are designed to accommodate invoice, letter, letter R, legal and ledger size paper. To change the paper size, consult your service technician for proper instructions.

Adding Paper ()

3000 Sheet Large Capacity Cassette (LCC)

1

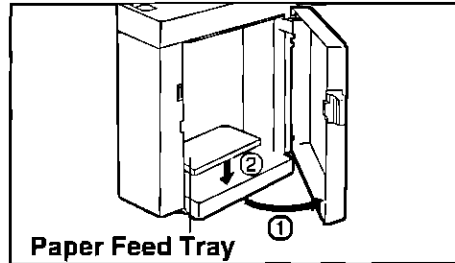

- ① Open the door.
- ② The paper feed tray will go down.

Do not touch the tray while it is moving.

2

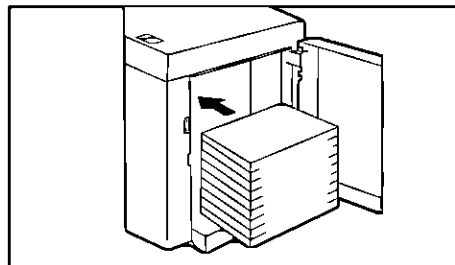

Add paper.

After tray stops, place paper neatly on to tray.
Letter size only (portrait).

3

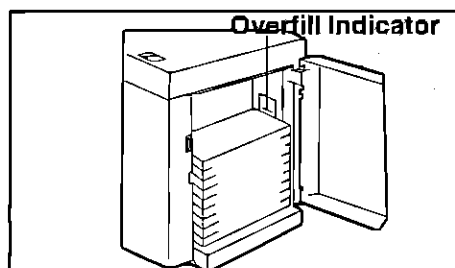

Do not fill above red line.

Up to 3000 sheets, 20 lbs.

4

Close the door.

Adding Toner (U13)

1

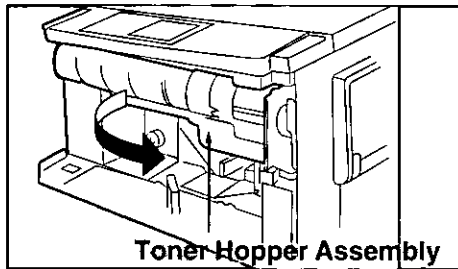

Open front panel

Turn toner hopper assembly

2

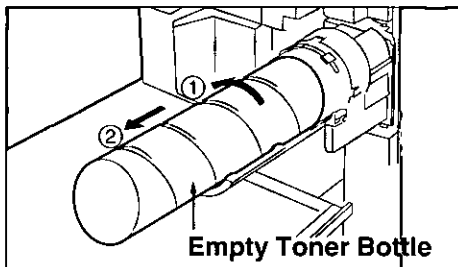

- ① Turn empty toner bottle until it stops
- ② Slide empty toner bottle towards you and remove

3

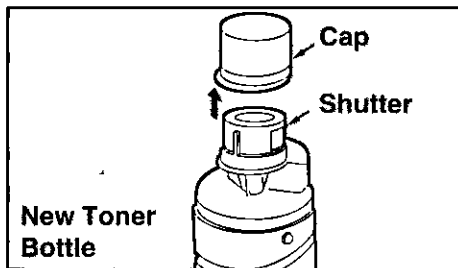

Shake well before using
10–15 times until the toner inside is
evenly distributed

Remove the cap from the bottle

Do not turn the shutter

4

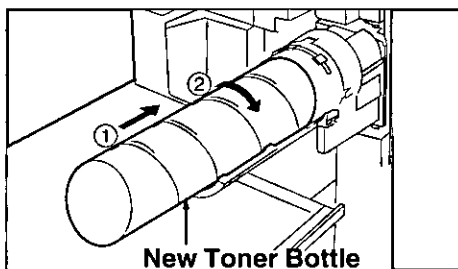

- ① Insert new toner bottle to the hopper assembly
- ② Turn the bottle until it stops, and arrows are aligned

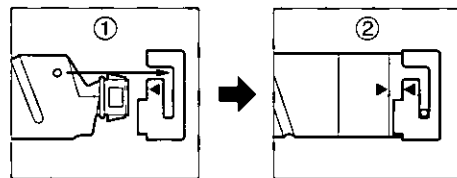

5

Return toner hopper assembly to
original position
Close front panel

ATTENTION

- Make sure the power switch is turned off before adding toner.
- For optimum copy quality use the recommended Panasonic toner. Store toner in a cool dark place. Do not unseal toner before use. Use it as fast as possible after unsealing.



Replacing the Waste Toner Bottle (U14)

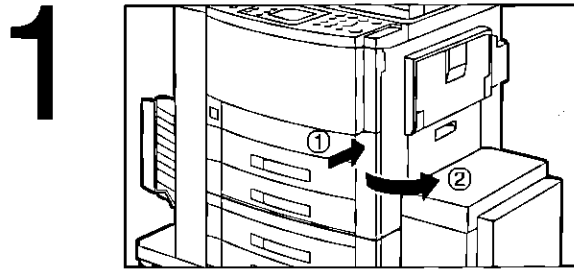

Open waste toner bottle cover.

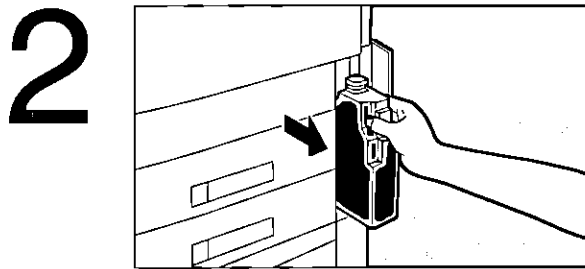

Slowly pull waste toner bottle straight out.

Do not squeeze the bottle.

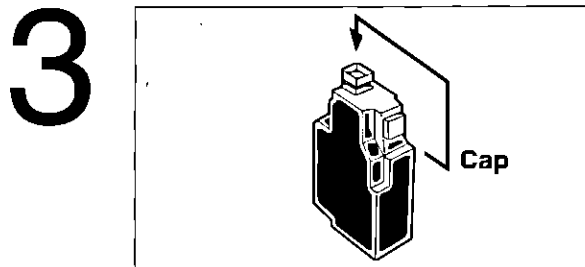

Close bottle with cap.

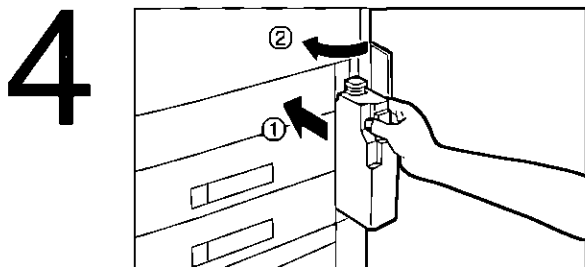

Install new bottle.

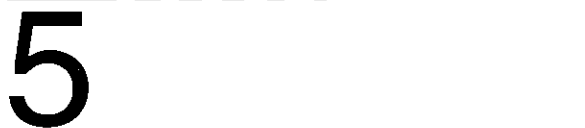

Close waste toner bottle cover.

ATTENTION

- Do not use toner in waste toner bottle.

NOTE



- If you have no replacement waste toner bottle, please contact your service provider.

Removing a paper misfeed (8V)

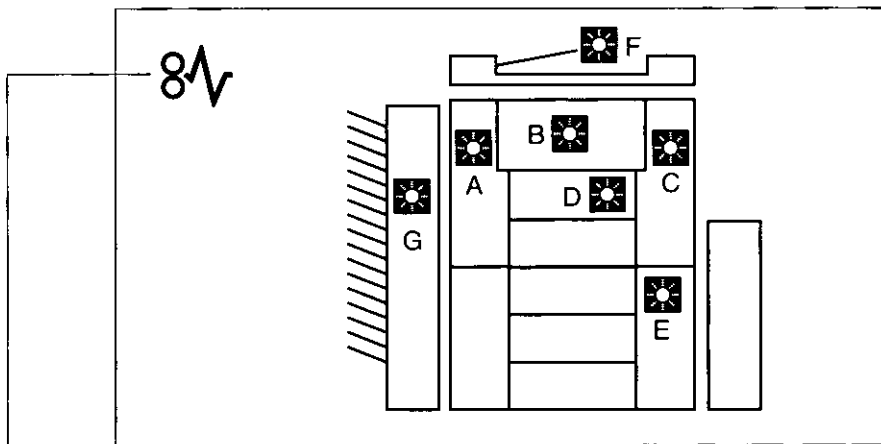
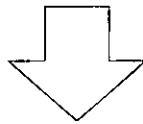
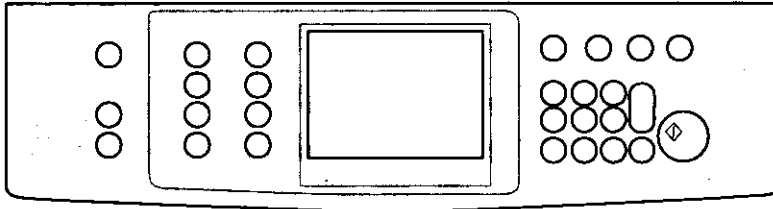
- When paper misfeed has occurred, the misfeed indicator and misfeed position(s) will be indicated on the touch panel display.



Paper Misfeed Positions

 <p>Copier or System Console</p>	<p>A: The paper exit area (See P.52) B: Paper transport area (See P.53) C: Paper entry area (See P.53) LCC, Large Capacity Cassette (See P.55) D: Automatic Duplex Unit (See P.54) E: System Console (See P.55)</p>
 <p>ADF i-ADF</p>	<p>F: ADF/i-ADF (See P.56–57)</p>
 <p>Sorter</p>	<p>G: 20 Bin Sorter (See P.58)</p>

Removing a paper misfeed (8¹/_V)

Paper exit area

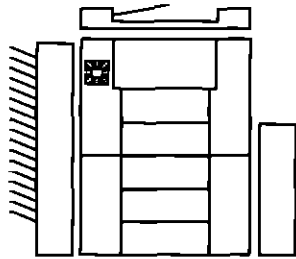

1

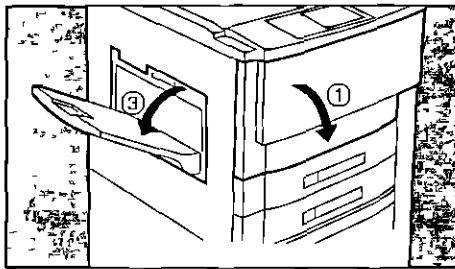

- ① Open front panel
- ② Move the sorter to the left if installed (See P 46)
- ③ Open exit cover

2

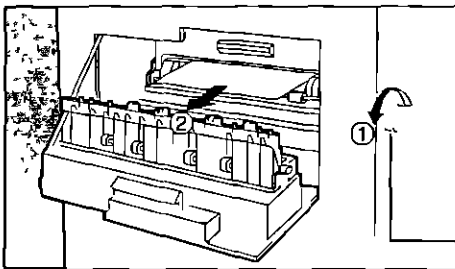

- ① Turn the left paper clearing knob
- ② Remove misfed paper

Left Paper Clearing Knob

3

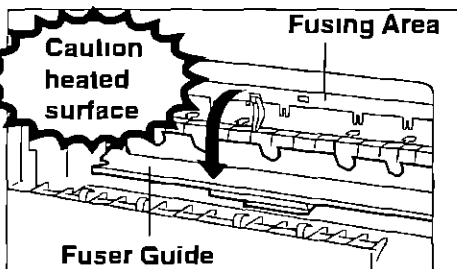

Caution: this fuser area may be hot

- ① Open the fuser guide
- ② Check that no misfed paper is remaining
- ③ Close the fuser guide

4

- ① Close exit cover
- ② Close front panel

ATTENTION

- The fusing area may be hot, so use caution when removing misfed paper
- The front panel must be opened prior to opening the exit cover

Paper transport and paper entry areas

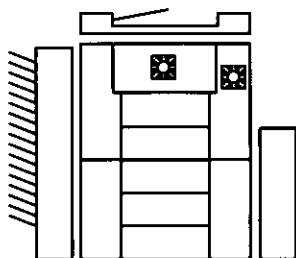

1

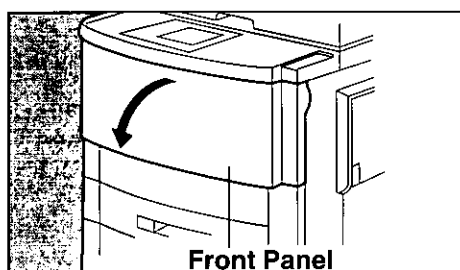

Open front panel.

2

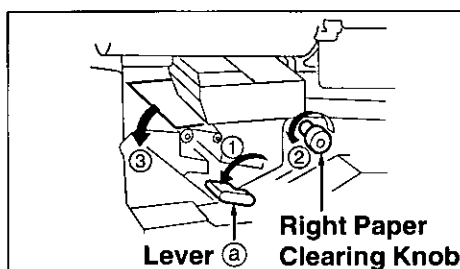

- ① Lower lever a.
- ② If copy paper is fed far into the copier, turn the right paper clearing knob.
- ③ Remove misfed paper.
- ④ Close front panel.

3

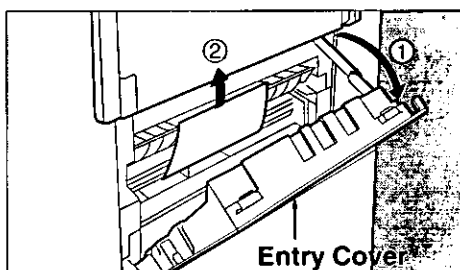

- ① Open entry cover.
- ② Remove misfed paper.
- ③ Close the entry cover.

Removing a paper misfeed (8 \sqrt{V})

Automatic Duplex Unit

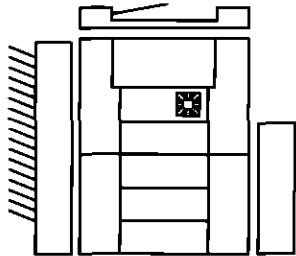

1

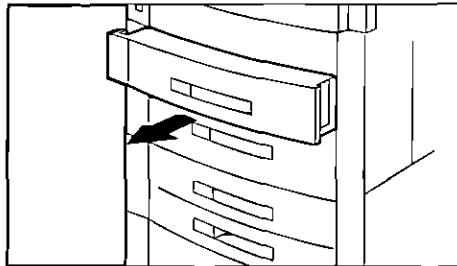

Pull out automatic duplex unit.

2

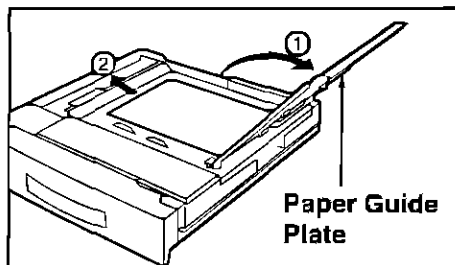

- ① Open paper guide plate.
- ② Remove misfed paper.
- ③ Close paper guide plate.

3

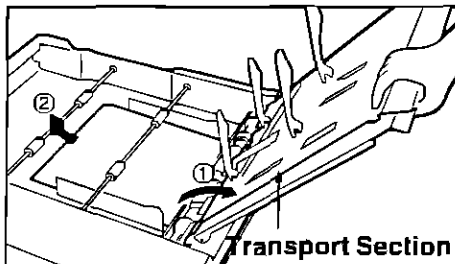

If misfeed is too far into the automatic duplex unit:

- ① Open paper transport section, until it stops.
- ② Remove misfed paper.
- ③ Close paper transport section.

4

Push back automatic duplex unit.

System console/Large Capacity Cassette

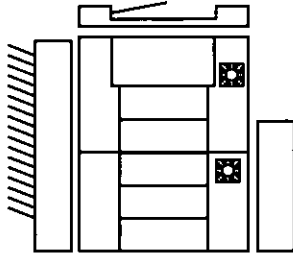

1

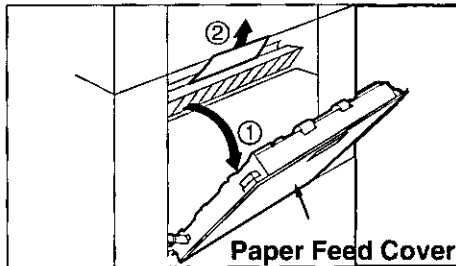

System Console

- ① Open the paper feed cover.
- ② Remove misfed paper.
- ③ Close the paper feed cover.

2

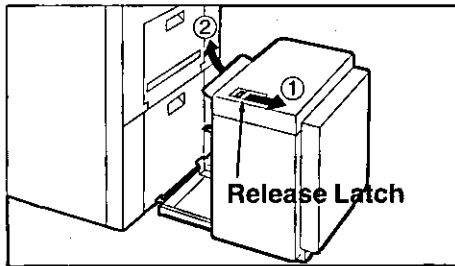

Large Capacity Cassette

- ① Hold the latch and slide the large capacity cassette to the right.
- ② Remove misfed paper.

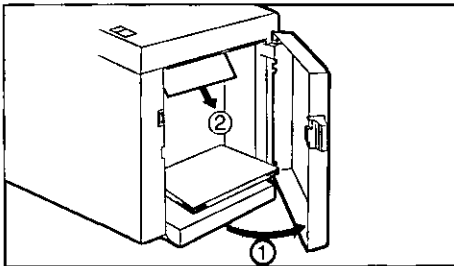

- ① Open the door.
- ② Remove misfed paper.
- ③ Close the door.
- ④ Return the large capacity cassette to original position.

Removing a paper misfeed (←≡)

i-ADF

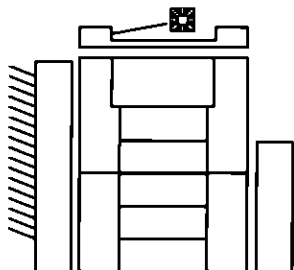

1

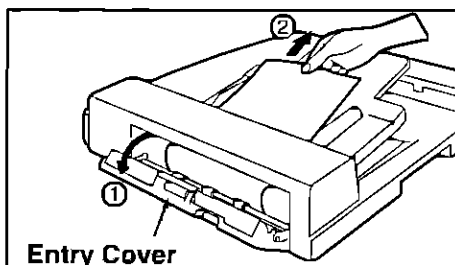

Entry Area

- ① Open entry cover.
- ② Remove misfed paper.
- ③ Close entry cover.

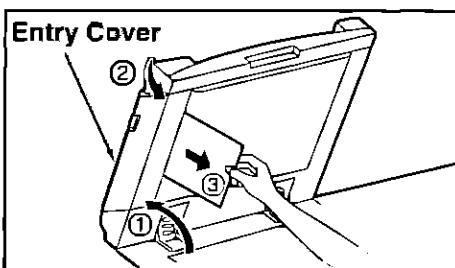

- ① Open the i-ADF.
- ② Open entry cover.
- ③ Remove misfed paper.
- ④ Close entry cover and the i-ADF.

2

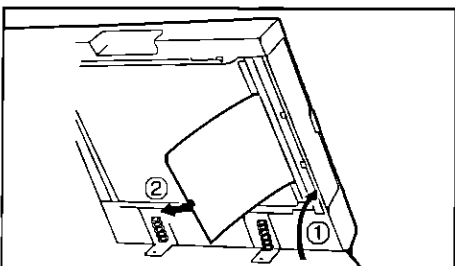

Exit Area

- ① Open the i-ADF.
- ② Remove misfed paper.
If paper is remaining on the platen glass, remove it.

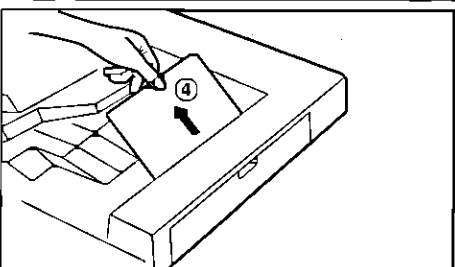

If paper cannot be removed:

- ③ Close the i-ADF.
- ④ Remove misfed paper.

ADF

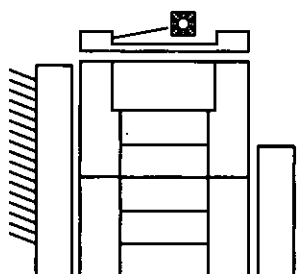

1

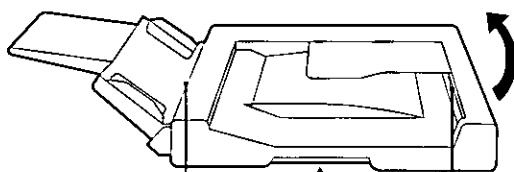

Open the ADF.

Entry Area Platen Area Exit Area

2

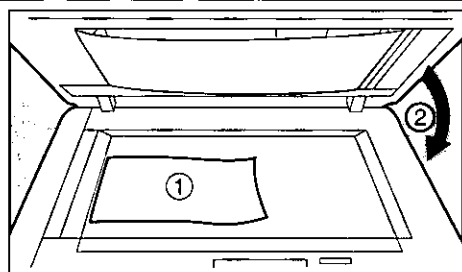

Platen Area

- ① Remove misfed paper.
- ② Close the ADF.

3



Entry Area

- ① Push the Release key and remove misfed paper.
- ② Close the ADF.

4

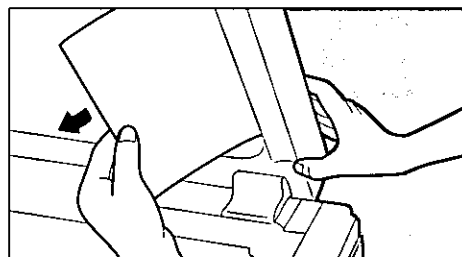

Exit Area

- ① Remove misfed paper.
- ② Close the ADF.



Removing a paper misfeed (≡□)

Sorter

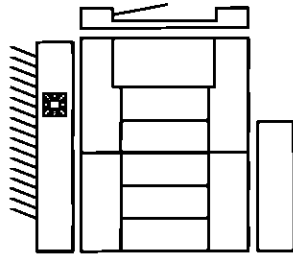

1

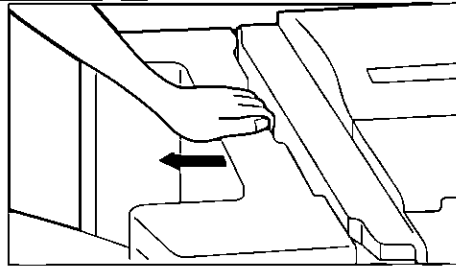

Pull the sorter toward the left slowly until it stops

2

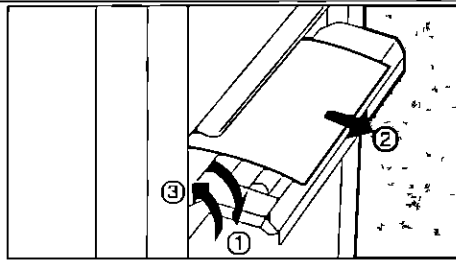

For FA-S575

- ① Open transport cover
- ② Remove misfed paper
- ③ Close transport cover

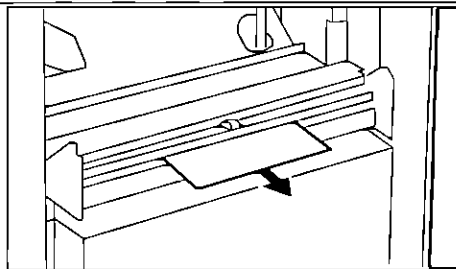

For FA-S680

Remove misfed paper

3

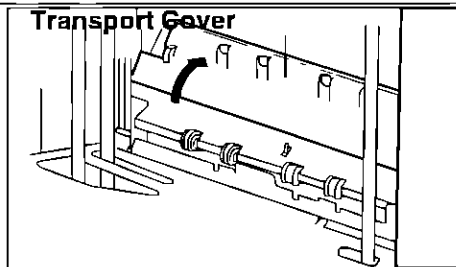

For FA-S680

- ① Open transport cover
- ② Check that paper is removed completely
- ③ Close transport cover

4

Slide the sorter against the copier

Specifications

■ FP-7742/7750

Type	Desktop
Process	UltraMagnefine™ Toner
Multi Copy Speed	42 letter size copies per minute (FP-7742) 50 letter size copies per minute (FP-7750)
Maximum Copy Size	11" × 17" (Ledger size) Void Area max 5 0 mm
Copy Size	Invoice, Letter, Letter R, Legal, Ledger via paper drawer/tray 4" × 6" — 11" × 17" via sheet bypass
Reduction Ratios	Preset 50%, 61%, 65%, 77%, 79% Variable from 99% to 50% in 1% increments
Enlargement Ratios	Preset 121%, 129%, 155%, 200% Variable from 101% to 200% in 1% increments
Paper Feed	550 sheet paper drawer plus 50 sheet Bypass Automatic Switching Automatic Duplex Unit holds up to 50 sheets
Paper Selection	Automatic
Paper Weight	16 – 24 lbs (15 – 30 lbs via sheet bypass)
Quantity Selector	1 – 999, Automatic Repeat, Automatic Reset to 1
Exposure Control	Automatic/Manual plus Photo Mode
Toner Supply	Automatic
Dimensions	23 9" (W) × 26 0" (D) × 22 9" (H)
Weight	161 lbs (FP-7742), 161 5 lbs (FP-7750)
Electrical Requirement	AC 120V, 60Hz, 12A

■ i-ADF (FA-A888), ADF (FA-A505)

Original Capacity	30 sheets/legal, ledger 50 sheets/invoice, letter
Paper Size	Invoice, Letter, Letter R, Legal, Ledger
Paper Weight	14 – 28 lbs
Electrical Requirement	Supplied from copier
Dimensions	22 8" (W) × 18 9" (D) × 3 7" (H) without Tray (FA-A505) 23 6" (W) × 20 4" (D) × 4 7" (H) without Tray (FA-A888)
Weight	22 0 lbs (FA-A505) 26 4 lbs (FA-A888)

Specifications are subject to change without notice



Specifications

■ 20 Bin Sorter (FA-S575/S680)

	FA-S575	FA-S680 (Staple)
Paper Size	Letter/Letter R/Legal/Ledger/Invoice	Letter/Letter R/Legal/Ledger/Invoice
Paper Weight	16 – 24 lbs	16 – 24 lbs
Number of Bins	20	20 Plus stack tray
Bin Capacity		
Nonsort	Top bin 150 sheets (90 Sheets/ADU) Bins 2-20 50 sheets	Nonsort tray 100 (75*) sheets Bins 1-20 30 sheets (25 Sheets/Ledger)
Staple sort	—	50 sheets (30 Sheets/Ledger) (Except Invoice size)
Sort	50 sheets	50 sheets (30 Sheets/Ledger)
Group	Top bin 150 sheets Bins 2-20 50 sheets	30 sheets (25 Sheets/Ledger)
Electrical Requirements	Supplied from copier	Supplied from copier
Dimensions	14 2" (W) x 19 2" (D) x 38 4" (H)	20 9" (W) x 22 3" (D) x 38 3" (H)
Weight	72 6 lbs	99 0 lbs

* When more than 100 copies are selected, 75 copies are stacked in the Nonsort tray and the balance in the sort bins

■ System Console (FA-DS82)

Combination	550 Sheet Paper Drawer x 1 Storage Drawer x 1
Paper Size	Invoice, Letter, Letter R, Legal, Ledger
Paper Weight	16 – 24 lbs
Electrical Requirements	Supplied from copier
Dimensions	23 9" (W) x 25 0" (D) x 16 4" (H)
Weight	58 7 lbs

■ Large Capacity Cassette (FA-MA301)

Paper Size	Letter
Paper Weight	16 – 24 lbs
Paper Capacity	Maximum 3000 sheets, 20 lbs
Electrical Requirements	Supplied from system console
Dimensions	11 4" (W) x 17 5" (D) x 20 4" (H)
Weight	30 8 lbs

Specifications are subject to change without notice

Troubleshooting

Before you call service

Check

Action

Unit does not operate

Does the display light?
(See P.8)



Check if the Power Switch is turned on and if the power plug is inserted into the outlet.

Does the Energy saver key flash (or light) and displays are turned OFF?
(See P.8)



Press Energy saver key on control panel.

Do any of U00 codes and messages appear on display?
(U0, U4, U10, U14....etc.,)



Perform actions in accordance with each message.

Do the over flow indicator and message appear on display? (OF)
(See P.45)



Remove copies from the sorter bin(s), and press the sorter mode select keys.
(See P.45)

Do the add staples indicator and message appear on display? (S)
(See P.46)



If staples are not empty, call service.
(Staples are jammed.)

Do the add paper indicator and message appear on display? (P)
(See P.47-48)



Add paper. (See P.47-48)

Do paper misfeed indicator and message appear on display? (M)
(See P.51-58)



Remove misfed paper. (See P.51-58)

Do any of E0-00 indicator and message appear on display?
(See P.8-9)



Turn copier off, then on. If error code does not go off, call service.

Troubleshooting

Before you call service

Check

Action

Copies are light

Does the exposure indicator say "light"?
(See P.11)



Touch the "dark" key or touch the "Auto" key to choose the auto mode. (See P.11)

Do the add toner indicator and message appear on displays? (See P.49)



Add toner. (See P.49)

Copies are marked

Is the copier platen glass or platen cover dirty?



Clean it. (See below)

■ If the measures outlined above do not solve the problem, call Service.

■ Care of Copier

As a rule, clean weekly.

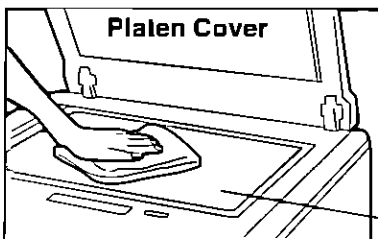

Platen/Platen Cover

- ① Wipe marks off with cloth and neutral detergent.
- ② Wipe again with dry cloth.

Platen

U.S.A. only

WARRANTY

"PANASONIC OFFICE PRODUCTS COMPANY MAKES NO WARRANTIES, GUARANTEES OR REPRESENTATIONS, EXPRESSED OR IMPLIED, TO CUSTOMER WITH RESPECT TO THIS PANASONIC COPIER, INCLUDING BUT NOT LIMITED TO, ANY IMPLIED WARRANTY OF MERCHANTABILITY OR FITNESS FOR A PARTICULAR PURPOSE.

PANASONIC OFFICE PRODUCTS COMPANY ASSUMES NO RISK AND SHALL NOT BE SUBJECT TO LIABILITY FOR ANY DAMAGE, INCLUDING, BUT NOT LIMITED TO DIRECT, INDIRECT, SPECIAL, INCIDENTAL OR CONSEQUENTIAL DAMAGES OR LOSS OF PROFITS SUSTAINED BY THE CUSTOMER IN CONNECTION WITH THE USE OR APPLICATION OF THIS PANASONIC COPIER. SEE YOUR DEALER FOR DETAILS OF DEALER'S WARRANTY."

For Service Call: _____

Panasonic Office Products Company
A unit of Matsushita Electric Corporation of America
Plain Paper Copier Division
Two Panasonic Way, Secaucus, N.J. 07094

Matsushita Electric of Canada Limited
5770 Ambler Drive, Mississauga,
Ontario L4W 2T3

FFPTD0745 Printed in Japan
July 1996
S0796-0