

# Attachment Illustrated Parts List



## Attachment

Mfg. No.	Description
1693270	Weight Carrier, Rear

## **Simplicity**

MANUFACTURING, INC.  
500 N. Spring Street / PO Box 997  
Port Washington, WI 53074-0997 USA

[www.simplicitymfg.com](http://www.simplicitymfg.com)

© Copyright 2003 Simplicity Manufacturing, Inc. All Rights Reserved. Printed In USA.

Rev. 09/2003

TP 400-3913-00-AT-SMA

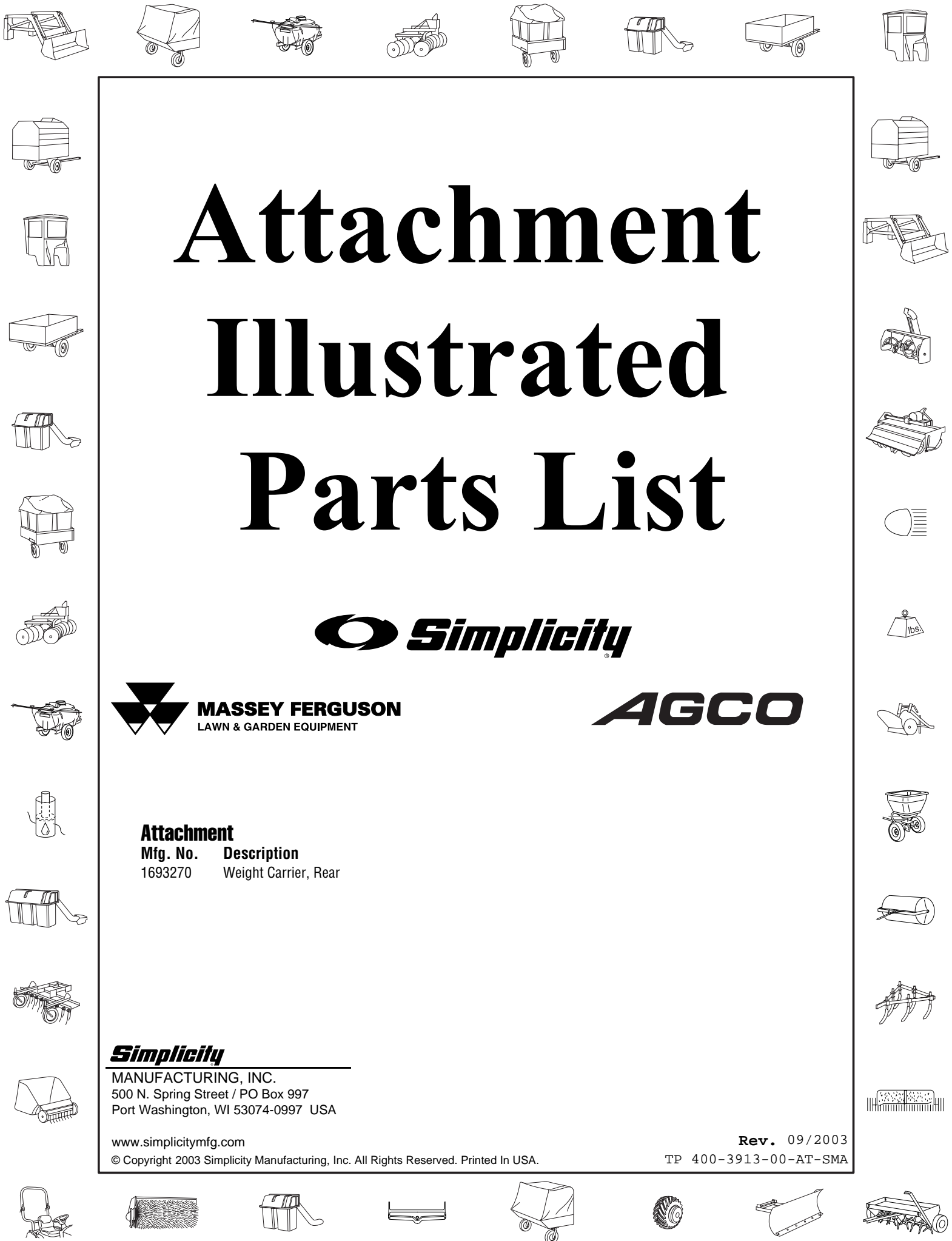

## Carrier Group - Rear Weight

985462

NOTE: Unless noted otherwise,  
use the standard hardware torque  
specification chart.

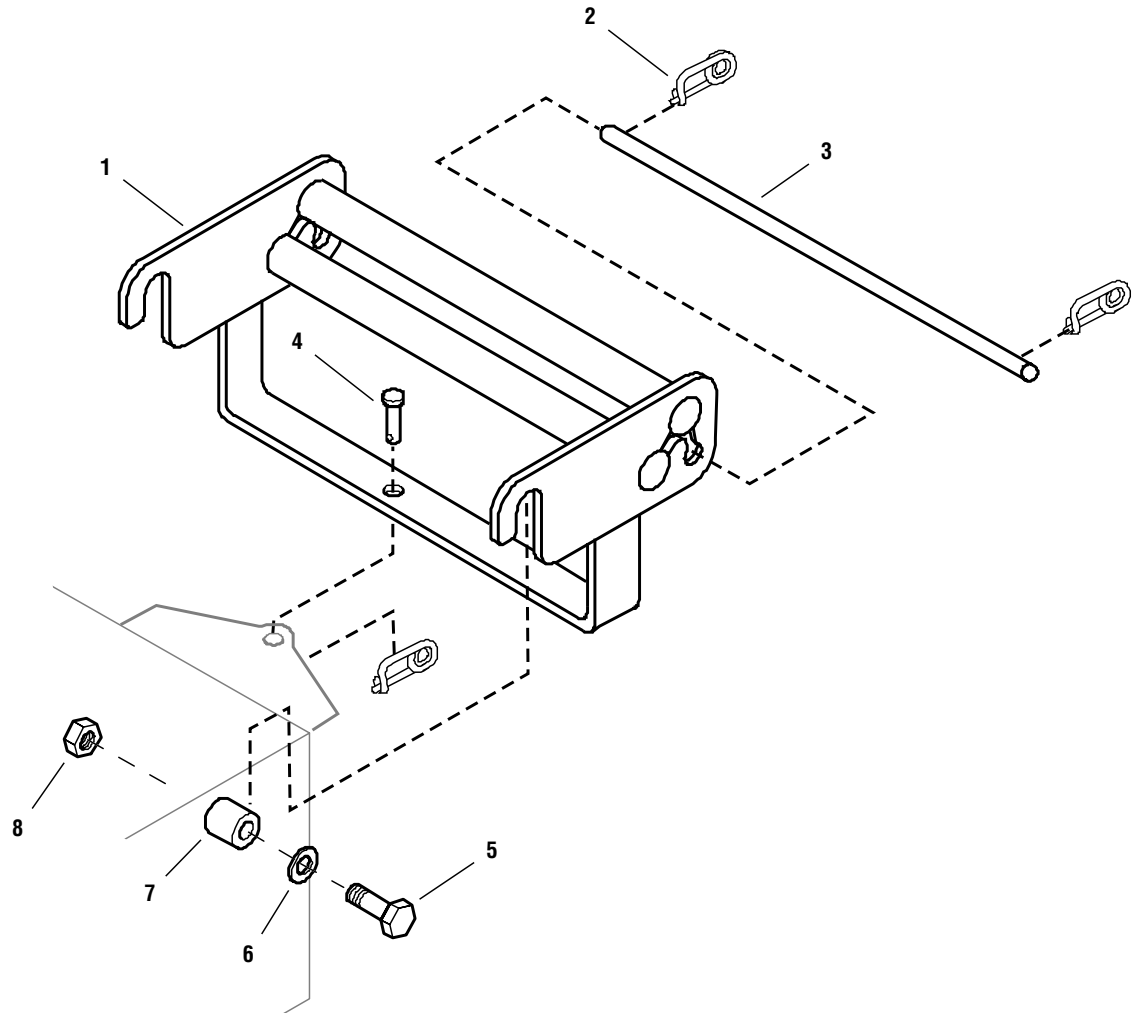

The above parts group applies to the following Mfg. Nos.:  
1693270 - Weight Carri

### **Carrier Group - Rear Weight**

---

<b>REF NO.</b>	<b>PART NO.</b>	<b>QTY.</b>	<b>DESCRIPTION</b>
1	1719287	1	HITCH ASSEMBLY
2	176012	3	CLIP, Safety
3	1719250	1	ROD, Locking
4	102004	1	PIN
5	1920415	2	CAPSCREW, 3/8-16 x 1-1/4
6	1924940	2	WASHER
7	158227	2	SPACER
8	1928352	2	

### **Footnotes**

---

**The above parts group applies to the following Mfg. Nos.:**

1693270 - Weight Carrie

# Hardware Identification & Torque Specifications

## Common Hardware Types

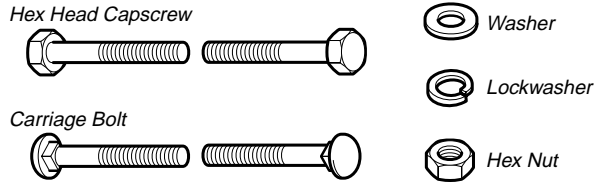

## Standard Hardware Sizing

When a washer or nut is identified as  $1/2''$ , this is the *Nominal size*, meaning the *inside diameter* is  $1/2$  inch; if a second number is present it represent the *threads per inch*

When bolt or capscrew is identified as  $1/2 - 16 \times 2''$ , this means the *Nominal size*, or *body diameter* is  $1/2$  inch; the second number represents the *threads per inch* (16 in this example, and the final number is the *body length* of the bolt or screw (in this example 2 inches long).

**The guides and ruler furnished below are designed to help you select the appropriate hardware and tools.**

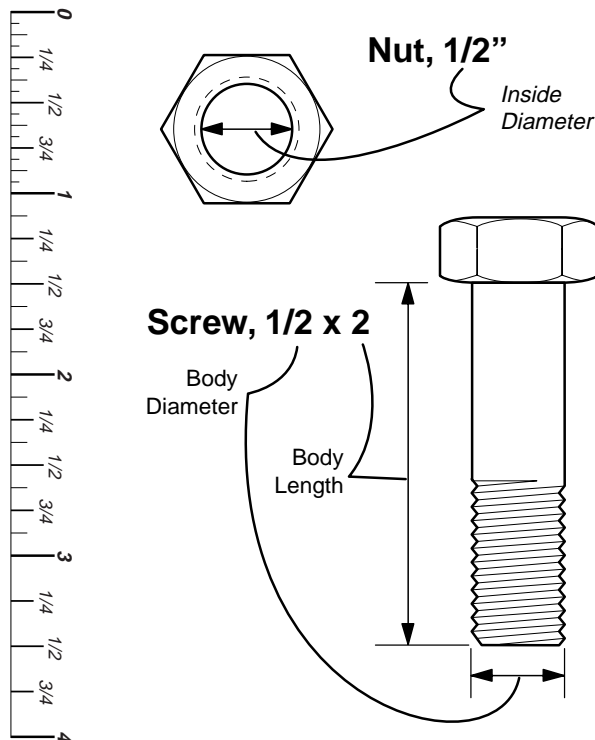

Torque Specification Chart						
FOR STANDARD MACHINE HARDWARE (Tolerance $\pm 20\%$ )						
Hardware Grade	No Marks SAE Grade 2		SAE Grade 5		SAE Grade 8	
	in/lbs ft/lbs	Nm.	in/lbs ft/lbs	Nm.	in/lbs ft/lbs	Nm.
8-32	19	2.1	30	3.4	41	4.6
8-36	20	2.3	31	3.5	43	4.9
10-24	27	3.1	43	4.9	60	6.8
10-32	31	3.5	49	5.5	68	7.7
1/4-20	66	7.6	8	10.9	12	16.3
1/4-28	76	8.6	10	13.6	14	19.0
5/16-18	11	15.0	17	23.1	25	34.0
5/16-24	12	16.3	19	25.8	27	34.0
3/8-16	20	27.2	30	40.8	45	61.2
3/8-24	23	31.3	35	47.6	50	68.0
7/16-14	30	40.8	50	68.0	70	95.2
7/16-20	35	47.6	55	74.8	80	108.8
1/2-13	50	68.0	75	102.0	110	149.6
1/2-20	55	74.8	90	122.4	120	163.2
9/16-12	65	88.4	110	149.6	150	204.0
9/16-18	75	102.0	120	163.2	170	231.2
5/8-11	90	122.4	150	204.0	220	299.2
5/8-18	100	136	180	244.8	240	326.4
3/4-10	160	217.6	260	353.6	386	525.0
3/4-16	180	244.8	300	408.0	420	571.2
7/8-9	140	190.4	400	544.0	600	816.0
7/8-14	155	210.8	440	598.4	660	897.6
1-8	220	299.2	580	788.8	900	1,244.0
1-12	240	326.4	640	870.4	1,000	1,360.0

### NOTES

- These torque values are to be used for all hardware excluding: locknuts, self-tapping screws, thread forming screws, sheet metal screws and socket head setscrews.
- Recommended seating torque values for locknuts:
  - for prevailing torque locknuts - use 65% of grade 5 torques.
  - for flange whizlock nuts and screws - use 135% of grade 5 torques.
- Unless otherwise noted on assembly drawings, all torque values must meet this specification.

## Wrench & Fastener Size Guide



$1/4''$  Bolt or Nut  
Wrench— $7/16''$

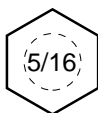

$5/16''$  Bolt or Nut  
Wrench— $1/2''$

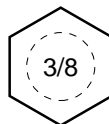

$3/8''$  Bolt or Nut  
Wrench— $9/16''$



$7/16''$  Bolt or Nut  
Wrench (Bolt)— $5/8''$   
Wrench (Nut)— $11/16''$

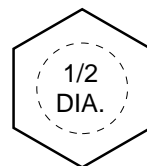

$1/2''$  Bolt or Nut  
Wrench— $3/4''$