



# *HTR-5930*

---

---

*AV Receiver*

OWNER'S MANUAL

# IMPORTANT SAFETY INSTRUCTIONS

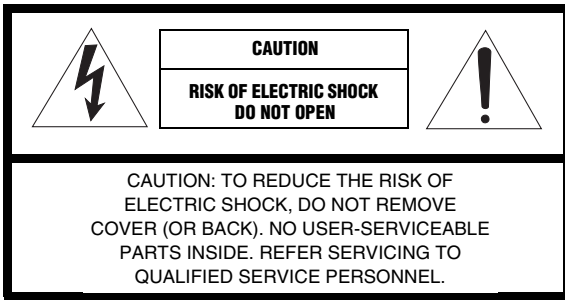

## • Explanation of Graphical Symbols



The lightning flash with arrowhead symbol, within an equilateral triangle, is intended to alert you to the presence of uninsulated “dangerous voltage” within the product’s enclosure that may be of sufficient magnitude to constitute a risk of electric shock to persons.



The exclamation point within an equilateral triangle is intended to alert you to the presence of important operating and maintenance (servicing) instructions in the literature accompanying the appliance.

- 1** Read Instructions – All the safety and operating instructions should be read before the product is operated.
- 2** Retain Instructions – The safety and operating instructions should be retained for future reference.
- 3** Heed Warnings – All warnings on the product and in the operating instructions should be adhered to.
- 4** Follow Instructions – All operating and use instructions should be followed.
- 5** Cleaning – Unplug this product from the wall outlet before cleaning. Do not use liquid cleaners or aerosol cleaners.
- 6** Attachments – Do not use attachments not recommended by the product manufacturer as they may cause hazards.
- 7** Water and Moisture – Do not use this product near water – for example, near a bath tub, wash bowl, kitchen sink, or laundry tub; in a wet basement; or near a swimming pool; and the like.
- 8** Accessories – Do not place this product on an unstable cart, stand, tripod, bracket, or table. The product may fall, causing serious injury to a child or adult, and serious damage to the product. Use only with a cart, stand, tripod, bracket, or table recommended by the manufacturer, or sold with the product. Any mounting of the product should follow the manufacturer’s instructions, and should use a mounting accessory recommended by the manufacturer.
- 9** A product and cart combination should be moved with care. Quick stops, excessive force, and uneven surfaces may cause the product and cart combination to overturn.



- 10** Ventilation – Slots and openings in the cabinet are provided for ventilation and to ensure reliable operation of the product and to protect it from overheating, and these openings must not be blocked or covered. The openings should never be blocked by placing the product on a bed, sofa, rug, or other similar surface. This product should not be placed in a built-in installation such as a bookcase or rack unless proper ventilation is provided or the manufacturer’s instructions have been adhered to.
- 11** Power Sources – This product should be operated only from the type of power source indicated on the marking label. If you are not sure of the type of power supply to your home, consult your product dealer or local power company. For products intended to operate from battery power, or other sources, refer to the operating instructions.
- 12** Grounding or Polarization – This product may be equipped with a polarized alternating current line plug (a plug having one blade wider than the other). This plug will fit into the power outlet only one way. This is a safety feature. If you are unable to insert the plug fully into the outlet, try reversing the plug. If the plug should still fail to fit, contact your electrician to replace your obsolete outlet. Do not defeat the safety purpose of the polarized plug.
- 13** Power-Cord Protection – Power-supply cords should be routed so that they are not likely to be walked on or pinched by items placed upon or against them, paying particular attention to cords at plugs, convenience receptacles, and the point where they exit from the product.
- 14** Lightning – For added protection for this product during a lightning storm, or when it is left unattended and unused for long periods of time, unplug it from the wall outlet and disconnect the antenna or cable system. This will prevent damage to the product due to lightning and power-line surges.
- 15** Power Lines – An outside antenna system should not be located in the vicinity of overhead power lines or other electric light or power circuits, or where it can fall into such power lines or circuits. When installing an outside antenna system, extreme care should be taken to keep from touching such power lines or circuits as contact with them might be fatal.
- 16** Overloading – Do not overload wall outlets, extension cords, or integral convenience receptacles as this can result in a risk of fire or electric shock.
- 17** Object and Liquid Entry – Never push objects of any kind into this product through openings as they may touch dangerous voltage points or short-out parts that could result in a fire or electric shock. Never spill liquid of any kind on the product.
- 18** Servicing – Do not attempt to service this product yourself as opening or removing covers may expose you to dangerous voltage or other hazards. Refer all servicing to qualified service personnel.
- 19** Damage Requiring Service – Unplug this product from the wall outlet and refer servicing to qualified service personnel under the following conditions:
  - a)** When the power-supply cord or plug is damaged,
  - b)** If liquid has been spilled, or objects have fallen into the product,
  - c)** If the product has been exposed to rain or water,

- d) If the product does not operate normally by following the operating instructions. Adjust only those controls that are covered by the operating instructions as an improper adjustment of other controls may result in damage and will often require extensive work by a qualified technician to restore the product to its normal operation,
  - e) If the product has been dropped or damaged in any way, and
  - f) When the product exhibits a distinct change in performance - this indicates a need for service.
- 20 Replacement Parts** – When replacement parts are required, be sure the service technician has used replacement parts specified by the manufacturer or have the same characteristics as the original part. Unauthorized substitutions may result in fire, electric shock, or other hazards.
- 21 Safety Check** – Upon completion of any service or repairs to this product, ask the service technician to perform safety checks to determine that the product is in proper operating condition.
- 22 Wall or Ceiling Mounting** – The unit should be mounted to a wall or ceiling only as recommended by the manufacturer.
- 23 Heat** – The product should be situated away from heat sources such as radiators, heat registers, stoves, or other products (including amplifiers) that produce heat.

- 24 Outdoor Antenna Grounding** – If an outside antenna or cable system is connected to the product, be sure the antenna or cable system is grounded so as to provide some protection against voltage surges and built-up static charges. Article 810 of the National Electrical Code, ANSI/NFPA 70, provides information with regard to proper grounding of the mast and supporting structure, grounding of the lead-in wire to an antenna discharge unit, size of grounding conductors, location of antenna discharge unit, connection to grounding electrodes, and requirements for the grounding electrode.

EXAMPLE OF ANTENNA GROUNDING

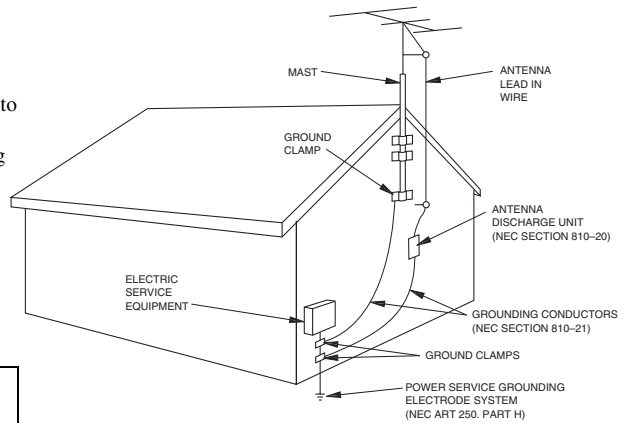

**Note to CATV system installer:**

This reminder is provided to call the CATV system installer’s attention to Article 820-40 of the NEC that provides guidelines for proper grounding and, in particular, specifies that the cable ground shall be connected to the grounding system of the building, as close to the point of cable entry as practical.

**FCC INFORMATION (for US customers)**

**1 IMPORTANT NOTICE: DO NOT MODIFY THIS UNIT!**

This product, when installed as indicated in the instructions contained in this manual, meets FCC requirements. Modifications not expressly approved by Yamaha may void your authority, granted by the FCC, to use the product.

- 2 IMPORTANT:** When connecting this product to accessories and/or another product use only high quality shielded cables. Cable/s supplied with this product **MUST** be used. Follow all installation instructions. Failure to follow instructions could void your FCC authorization to use this product in the USA.

- 3 NOTE:** This product has been tested and found to comply with the requirements listed in FCC Regulations, Part 15 for Class “B” digital devices. Compliance with these requirements provides a reasonable level of assurance that your use of this product in a residential environment will not result in harmful interference with other electronic devices.

This equipment generates/uses radio frequencies and, if not installed and used according to the instructions found in the users manual, may cause interference harmful to the operation of other electronic devices.

Compliance with FCC regulations does not guarantee that interference will not occur in all installations. If this product is found to be the source of interference, which can be determined by turning the unit “OFF” and “ON”, please try to eliminate the problem by using one of the following measures:

Relocate either this product or the device that is being affected by the interference.

Utilize power outlets that are on different branch (circuit breaker or fuse) circuits or install AC line filter/s.

In the case of radio or TV interference, relocate/reorient the antenna. If the antenna lead-in is 300 ohm ribbon lead, change the lead-in to coaxial type cable.

If these corrective measures do not produce satisfactory results, please contact the local retailer authorized to distribute this type of product. If you can not locate the appropriate retailer, please contact Yamaha Electronics Corp., U.S.A. 6660 Orangethorpe Ave, Buena Park, CA 90620.

The above statements apply **ONLY** to those products distributed by Yamaha Corporation of America or its subsidiaries.

# CAUTION: READ THIS BEFORE OPERATING YOUR UNIT.

- 1 To assure the finest performance, please read this manual carefully. Keep it in a safe place for future reference.
- 2 Install this sound system in a well ventilated, cool, dry, clean place – away from direct sunlight, heat sources, vibration, dust, moisture, and/or cold. Allow ventilation space of at least 30 cm on the top, 20 cm on the left and right, and 20 cm on the back of this unit.
- 3 Locate this unit away from other electrical appliances, motors, or transformers to avoid humming sounds.
- 4 Do not expose this unit to sudden temperature changes from cold to hot, and do not locate this unit in a environment with high humidity (i.e. a room with a humidifier) to prevent condensation inside this unit, which may cause an electrical shock, fire, damage to this unit, and/or personal injury.
- 5 Avoid installing this unit where foreign object may fall onto this unit and/or this unit may be exposed to liquid dripping or splashing. On the top of this unit, do not place:
  - Other components, as they may cause damage and/or discoloration on the surface of this unit.
  - Burning objects (i.e. candles), as they may cause fire, damage to this unit, and/or personal injury.
  - Containers with liquid in them, as they may fall and liquid may cause electrical shock to the user and/or damage to this unit.
- 6 Do not cover this unit with a newspaper, tablecloth, curtain, etc. in order not to obstruct heat radiation. If the temperature inside this unit rises, it may cause fire, damage to this unit, and/or personal injury.
- 7 Do not plug in this unit to a wall outlet until all connections are complete.
- 8 Do not operate this unit upside-down. It may overheat, possibly causing damage.
- 9 Do not use force on switches, knobs and/or cords.
- 10 When disconnecting the power cable from the wall outlet, grasp the plug; do not pull the cord.
- 11 Do not clean this unit with chemical solvents; this might damage the finish. Use a clean, dry cloth.
- 12 Only voltage specified on this unit must be used. Using this unit with a higher voltage than specified is dangerous and may cause fire, damage to this unit, and/or personal injury. YAMAHA will not be held responsible for any damage resulting from use of this unit with a voltage other than specified.
- 13 To prevent damage by lightning, keep the power cord and outdoor antennas disconnected from a wall outlet or the unit during a lightning storm.
- 14 Do not attempt to modify or fix this unit. Contact qualified YAMAHA service personnel when any service is needed. The cabinet should never be opened for any reasons.
- 15 When not planning to use this unit for long periods of time (i.e. vacation), disconnect the AC power plug from the wall outlet.
- 16 Install this unit near the AC outlet and where the AC power plug can be reached easily.
- 17 Be sure to read the “TROUBLESHOOTING” section on common operating errors before concluding that this unit is faulty.
- 18 Before moving this unit, press STANDBY/ON to set this unit in the standby mode, and disconnect the AC power plug from the wall outlet.
- 19 **VOLTAGE SELECTOR (Asia and General models only)**  
The **VOLTAGE SELECTOR** on the rear panel of this unit must be set for your local main voltage **BEFORE** plugging into the AC wall outlet.  
Voltages are 110–120/220–240 V AC, 50/60 Hz.

## WARNING

TO REDUCE THE RISK OF FIRE OR ELECTRIC SHOCK, DO NOT EXPOSE THIS UNIT TO RAIN OR MOISTURE.

This unit is not disconnected from the AC power source as long as it is connected to the wall outlet, even if this unit itself is turned off by STANDBY/ON. This state is called the standby mode. In this state, this unit is designed to consume a very small quantity of power.

## FOR CANADIAN CUSTOMERS

To prevent electric shock, match wide blade of plug to wide slot and fully insert.  
This Class B digital apparatus complies with Canadian ICES-003.

## IMPORTANT

Please record the serial number of this unit in the space below.  
MODEL:  
Serial No.:  
The serial number is located on the rear of the unit.  
Retain this Owner's Manual in a safe place for future reference.

## We Want You Listening For A Lifetime

YAMAHA and the Electronic Industries Association's Consumer Electronics Group want you to get the most out of your equipment by playing it at a safe level. One that lets the sound come through loud and clear without annoying blaring or distortion – and, most importantly, without affecting your sensitive hearing.

Since hearing damage from loud sounds is often undetectable until it is too late, YAMAHA and the Electronic Industries Association's Consumer Electronics Group recommend you to avoid prolonged exposure from excessive volume levels.



# CONTENTS

## INTRODUCTION

<b>FEATURES</b> .....	<b>2</b>
<b>GETTING STARTED</b> .....	<b>3</b>
Supplied accessories .....	3
Installing batteries in the remote control .....	3
<b>CONTROLS AND FUNCTIONS</b> .....	<b>4</b>
Front panel .....	4
Remote control.....	6
Front panel display .....	8
Rear panel .....	9

## PREPARATION

<b>CONNECTIONS</b> .....	<b>10</b>
Placing speakers.....	10
Connecting speakers .....	11
Information on jacks and cable plugs .....	13
Connecting video components.....	14
Connecting audio components.....	17
Connecting the FM and AM antennas .....	18
Connecting the power cable.....	19
Turning on the power.....	19
<b>SETUP</b> .....	<b>20</b>
Using BASIC MENU .....	20

## BASIC OPERATION

<b>PLAYBACK</b> .....	<b>23</b>
Basic operations.....	23
Additional operations.....	25
<b>SOUND FIELD PROGRAMS</b> .....	<b>30</b>
Sound field program descriptions .....	31
<b>RECORDING</b> .....	<b>34</b>
<b>FM/AM TUNING</b> .....	<b>35</b>
Automatic tuning .....	35
Manual tuning.....	36
Automatic preset tuning.....	37
Manual preset tuning .....	38
Selecting preset stations.....	39
Exchanging preset stations .....	40
<b>XM® SATELLITE RADIO TUNING</b> .....	<b>41</b>
What is XM Satellite Radio? .....	41
Connecting the XM Connect-and-Play digital antenna .....	41
XM Satellite Radio controls and functions.....	42
Activating XM Satellite Radio .....	43
Basic XM Satellite Radio operations.....	44
Selecting the XM Satellite Radio search mode .....	45
Setting XM Satellite Radio preset channels .....	49
Displaying the XM Satellite Radio information.....	50

## ADVANCED OPERATION

<b>SET MENU</b> .....	<b>52</b>
Using SET MENU .....	53
SOUND MENU.....	53
INPUT MENU .....	55
OPTION MENU .....	56
<b>REMOTE CONTROL FEATURES</b> .....	<b>57</b>
Controlling this unit, a TV, or other components....	57
Setting remote control codes .....	59

## ADDITIONAL INFORMATION

<b>TROUBLESHOOTING</b> .....	<b>60</b>
<b>RESETTING THE SYSTEM</b> .....	<b>65</b>
<b>GLOSSARY</b> .....	<b>66</b>
Audio information .....	66
Sound field program information .....	67
Video information.....	67
<b>SPECIFICATIONS</b> .....	<b>68</b>

INTRODUCTION

PREPARATION

BASIC  
OPERATION

ADVANCED  
OPERATION

ADDITIONAL  
INFORMATION

# FEATURES

## Built-in 5-channel power amplifier

- ◆ Minimum RMS output power

[U.S.A. and Canada models]  
(0.9% THD, 1 kHz, 8 Ω/6 Ω)

Front: 110 W + 110 W

Center: 110 W

Surround: 110 W + 110 W

[Other models]

(0.9% THD, 1 kHz, 6 Ω)

Front: 100 W + 100 W

Center: 100 W

Surround: 100 W + 100 W

## Decoders and DSP circuits

- ◆ Proprietary YAMAHA technology for the creation of multi-channel surround sound
- ◆ Dolby Digital decoder
- ◆ Dolby Pro Logic/Dolby Pro Logic II decoder
- ◆ DTS decoder
- ◆ Virtual CINEMA DSP
- ◆ SILENT CINEMA™

## Sophisticated AM/FM tuner

- ◆ 40-station random and direct preset tuning
- ◆ Automatic preset tuning
- ◆ Preset station shifting capability (preset editing)

## XM Satellite Radio (U.S.A. model only)

- ◆ XM Satellite Radio tuning capability (Using the “XM Connect-and-Play digital antenna” sold separately)

## Other features

- ◆ 192-kHz/24-bit D/A converter
- ◆ 6 additional input jacks for discrete multi-channel input
- ◆ A SET MENU that allows you to optimize this unit to suit your individual audiovisual system
- ◆ Component video input/output capability (3 COMPONENT VIDEO INs and 1 MONITOR OUT)
- ◆ Optical and coaxial digital audio signal jacks
- ◆ Sleep timer
- ◆ Night listening mode
- ◆ Remote control with preset remote control codes

-  indicates a tip for your operation.
- Some operations can be performed by using either the buttons on the front panel or the ones on the remote control. In case the button names differ between the front panel and the remote control, the button name on the remote control is given in parentheses.
- This manual is printed prior to production. Design and specifications are subject to change in part as a result of improvements, etc. In case of differences between the manual and product, the product has priority.



Manufactured under license from Dolby Laboratories.  
“Dolby”, “Pro Logic”, and the double-D symbol are trademarks of Dolby Laboratories.

SILENT™  
CINEMA

“SILENT CINEMA” is a trademark of YAMAHA CORPORATION.



“DTS” and “DTS Digital Surround” are registered trademarks of Digital Theater Systems, Inc.



The XM name and related logos are registered trademarks of XM Satellite Radio Inc.

# GETTING STARTED

## Supplied accessories

Check that you received all of the following parts.

Remote control

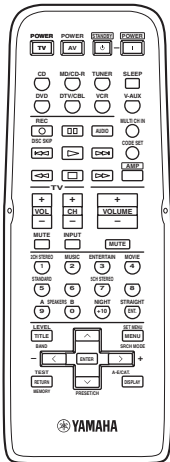

Batteries (2)  
(AA, R06, UM-3)

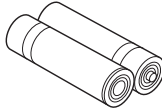

AM loop antenna



Indoor FM antenna  
(U.S.A., Canada, China, Asia  
and General models)

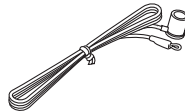

Indoor FM antenna  
(U.K., Europe, Australia  
and Korea models)

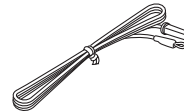

## Installing batteries in the remote control

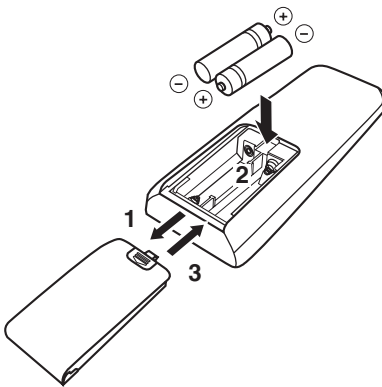

- 1** Press the  part and slide the battery compartment cover off.
- 2** Insert the two supplied batteries (AA, R06, UM-3) according to the polarity markings (+ and -) on the inside of the battery compartment.
- 3** Slide the cover back until it snaps into place.

### Notes

- Change all of the batteries if you notice a decrease in the operation range of the remote control.
- Do not use an old battery together with a new one.
- Do not use different types of batteries (such as alkaline and manganese batteries) together. Read the packaging carefully as these different types of batteries may have the same shape and color.
- If the batteries have leaked, dispose of them immediately. Avoid touching the leaked material or letting it come into contact with clothing, etc. Clean the battery compartment thoroughly before installing new batteries.
- Do not throw away batteries with general house waste; dispose of them correctly in accordance with your local regulations.
- If the remote control is without batteries for more than 2 minutes, or if exhausted batteries remain in the remote control, the contents of the memory may be cleared. When the memory is cleared, insert new batteries, set up the remote control code and program any acquired functions that may have been cleared.

# CONTROLS AND FUNCTIONS

## Front panel

### Note

The XM Satellite Radio controlling functions in the following buttons (SEARCH MODE, XM, CATEGORY, PRESET/TUNING/CH  $\triangleleft/\triangleright$ , MEMORY, and DISPLAY) are only applicable to the U.S.A. model and are operational only when “XM” is selected as the input source. For details, see “XM Satellite Radio controls and functions” on page 42.

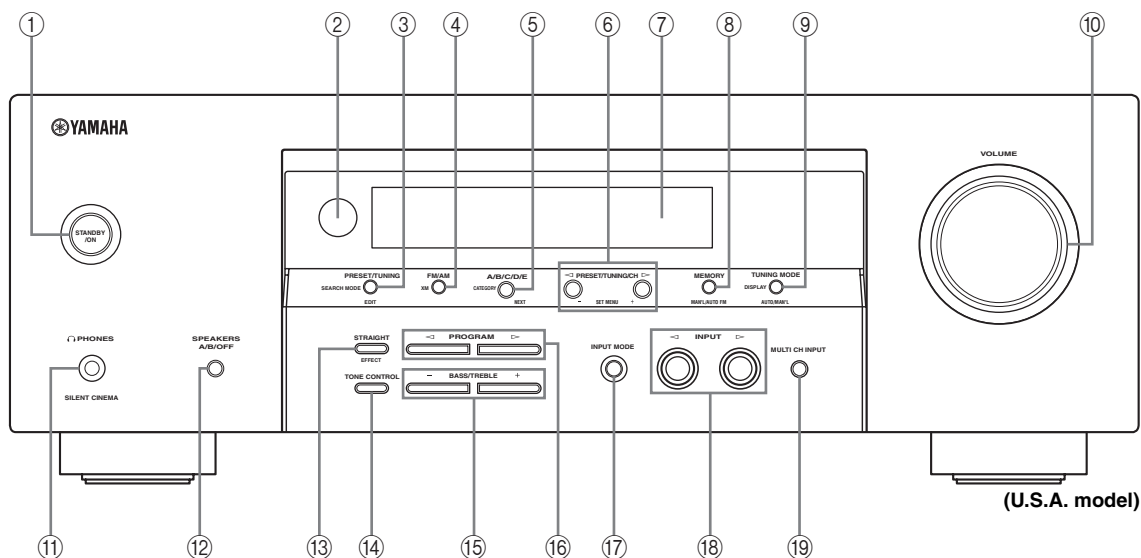

(U.S.A. model)

### ① STANDBY/ON

Turns on this unit or sets it to the standby mode.

### Notes

- In the standby mode, this unit consumes a small amount of power in order to receive infrared-signals from the remote control.
- When you turn on this unit, there will be a 4 to 5-second delay before this unit can reproduce sound.

### ② Remote control sensor

Receives signals from the remote control.

### ③ PRESET/TUNING

- Switches the function of PRESET/TUNING/CH  $\triangleleft/\triangleright$  between selecting preset station numbers and selecting the tuning frequency.
- Edits the assignments of present stations.

### ④ FM/AM

Switches the reception band between FM and AM.

### ⑤ A/B/C/D/E

Selects one of the 5 preset station groups (A to E) when “FM” or “AM” is selected as the input source.

### ⑥ PRESET/TUNING/CH $\triangleleft/\triangleright$

- Selects one of the 8 preset station numbers (1 to 8) when “FM” or “AM” is selected as the input source. The colon (:) is displayed in the front panel display.
- Selects the tuning frequency when “FM” or “AM” is selected as the input source. The colon (:) is not displayed in the front panel display.

### ⑦ Front panel display

Shows information about the operational status of this unit.

### ⑧ MEMORY

Stores a preset station in the memory. Hold down this button for more than 3 seconds to start automatic preset tuning.

### ⑨ TUNING MODE

Switches between automatic tuning (the AUTO indicator is turned on) and manual tuning (the AUTO indicator is turned off).

### ⑩ VOLUME

Controls the output level of all audio channels.

### Note

This does not affect the AUDIO OUT (REC) level.



**⑪ PHONES jack**

Outputs audio signals for private listening with headphones.

**Notes**

- When you connect headphones, no signals are output at the SUBWOOFER OUTPUT jack or at the SPEAKERS terminals.
- All Dolby Digital and DTS audio signals are mixed down to the left and right headphone channels.

**⑫ SPEAKERS**

Turns on or off the set of front speakers connected to the A and/or B terminals on the rear panel.

**⑬ STRAIGHT**

Turns the sound field programs off or on. When this unit is in the “STRAIGHT” mode, 2-channel or multi-channel input signals are output directly from their respective speakers without effect processing.

**⑭ TONE CONTROL**

Adjusts the bass/treble balance of the front left and right speakers in conjunction with BASS/TREBLE +/-.

**⑮ BASS/TREBLE +/-**

Adjusts the bass/treble balance of the front left and right speakers in conjunction with TONE CONTROL.

**⑯ PROGRAM </>**

Selects sound field programs.

**⑰ INPUT MODE**

Selects either digital or analog input signals exclusively or sets this unit to automatically detect the type of input signals and select the corresponding input signals when one component is connected via both digital and analog connections.

**⑱ INPUT </>**

Selects the desired input source.

**⑲ MULTI CH INPUT**

Selects the component connected to the MULTI CH INPUT jacks as the input source.

**Note**

The input source connected to the MULTI CH INPUT jacks takes priority over the source selected with INPUT </> on the front panel (or the input selector buttons on the remote control).

## Remote control

This section describes the function of each control on the remote control used to control this unit. To operate other components, see “REMOTE CONTROL FEATURES” on page 57.

### Note

The XM Satellite Radio controlling functions in the following buttons (BAND, MEMORY, SRCH MODE, DISPLAY, cursor buttons  $\wedge/\vee/ \langle/\rangle$ , numeric buttons and ENT.) are only applicable to the U.S.A. model and are operational only when “XM” is selected as the input source. For details, see “XM Satellite Radio controls and functions” on page 42.

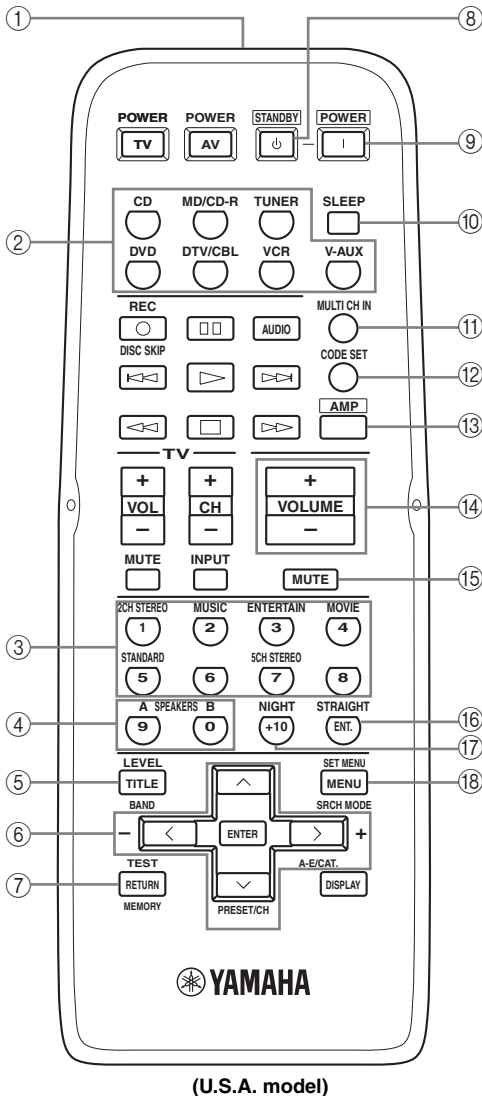

### Controlling this unit

Press AMP to control this unit.

#### ① Infrared signal transmitter

Outputs infrared control signals. Aim the transmitter at the component you want to operate.

#### ② Input selector buttons

Select the input source you want to control.

#### ③ Sound field program selector buttons

Select sound field programs.

#### ④ SPEAKERS A/B

Turn on or off the set of front speakers connected to the A and/or B terminals on the rear panel.

#### ⑤ LEVEL

Selects the speaker channel to be adjusted.

#### ⑥ Cursor buttons $\wedge/\vee/ \langle/\rangle$

Select and adjust sound field program parameters or SET MENU items.

#### ⑦ TEST

Outputs the test tone to adjust the speaker levels.

#### ⑧ STANDBY

Sets this unit to the standby mode.

#### ⑨ POWER

Turns on this unit.

#### ⑩ SLEEP

Sets the sleep timer.

#### ⑪ MULTI CH IN

Selects the component connected to the MULTI CH INPUT jacks as the input source when using an external decoder, etc.

#### ⑫ CODE SET

Use to set up remote control codes.

#### ⑬ AMP

Sets the remote control to the operation mode of this unit.

#### ⑭ VOLUME +/-

Controls the output level of all audio channels.

### Note

This does not affect the AUDIO OUT (REC) level.

**⑮ MUTE**

Mutes the audio output. Press again to restore the audio output to the previous volume level.

**⑯ STRAIGHT**

Turns the sound field programs off or on. When this unit is in the "STRAIGHT" mode, 2-channel or multi-channel input signals are output directly from their respective speakers without effect processing.

**⑰ NIGHT**

Turns on or off the night listening mode.

**⑱ SET MENU**

Enters "SET MENU".

**■ Controlling the TUNER functions**

To control the TUNER function, press TUNER and then BAND repeatedly to select "FM" or "AM" as the input source.

**③ Numeric buttons**

Select preset stations.

**⑤ BAND**

Switches the reception band between "FM" and "AM".

**⑥ A-E/CAT. </>, PRESET/CH ^ / v**

Press A-E/CAT. </> to select a preset station group (A to E) and PRESET/CH ^ / v to select a preset station number (1 to 8).

**■ Using the remote control**

The remote control transmits a directional infrared ray. Be sure to aim the remote control directly at the remote control sensor on this unit during operation.

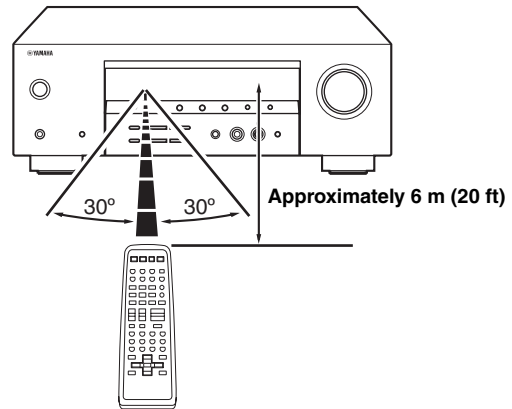
**Notes**

- Do not spill water or other liquids on the remote control.
- Do not drop the remote control.
- Do not leave or store the remote control in the following types of conditions:
  - places of high humidity, such as near a bath
  - places of high temperature, such as near a heater or stove
  - places of extremely low temperatures
  - dusty places

## Front panel display

### Note

The XM indicator is only applicable to the U.S.A. model and lights up only when “XM” is selected as the input source. For details, see “Basic XM Satellite Radio operations” on page 44.

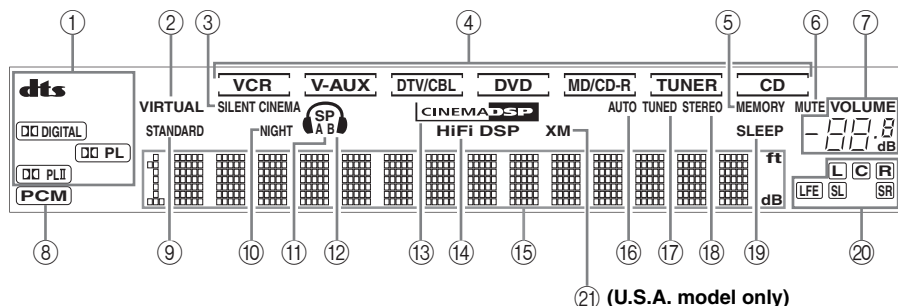

#### ① Decoder indicators

The respective indicator lights up when any of the decoders of this unit function.

#### ② VIRTUAL indicator

Lights up when Virtual CINEMA DSP is active.

#### ③ SILENT CINEMA indicator

Lights up when headphones are connected and a sound field program is selected.

#### ④ Input source indicators

A corresponding cursor lights up to show the currently selected input source.

#### ⑤ MEMORY indicator

Flashes to show that a station can be stored.

#### ⑥ MUTE indicator

Flashes while the MUTE function is on.

#### ⑦ VOLUME level indicator

Indicates the current volume level.

#### ⑧ PCM indicator

Lights up when this unit is reproducing PCM (Pulse Code Modulation) digital audio signals.

#### ⑨ STANDARD indicator

Lights up when the “STANDARD” program is selected.

#### ⑩ NIGHT indicator

Lights up when you select a night listening mode.

#### ⑪ Speaker indicators

Light up according to the set of front speakers selected.

#### ⑫ Headphones indicator

Lights up when headphones are connected.

#### ⑬ CINEMA DSP indicator

Lights up when you select a CINEMA DSP program.

#### ⑭ HiFi DSP indicator

Lights up when you select a HiFi DSP program.

#### ⑮ Multi-information display

Shows the name of the current program and other information when adjusting or changing settings.

#### ⑯ AUTO indicator

Lights up when this unit is in the automatic tuning mode.

#### ⑰ TUNED indicator

Lights up when this unit is tuned into a station.

#### ⑱ STEREO indicator

Lights up when this unit is receiving a strong signal for an FM stereo broadcast while the AUTO indicator is lit.

#### ⑲ SLEEP indicator

Lights up while the sleep timer is on.

#### ⑳ Input channel indicators

Indicate the channel components of the current digital input signal.

#### ㉑ XM indicator

Lights up when “XM” is selected as the input source.

## Rear panel

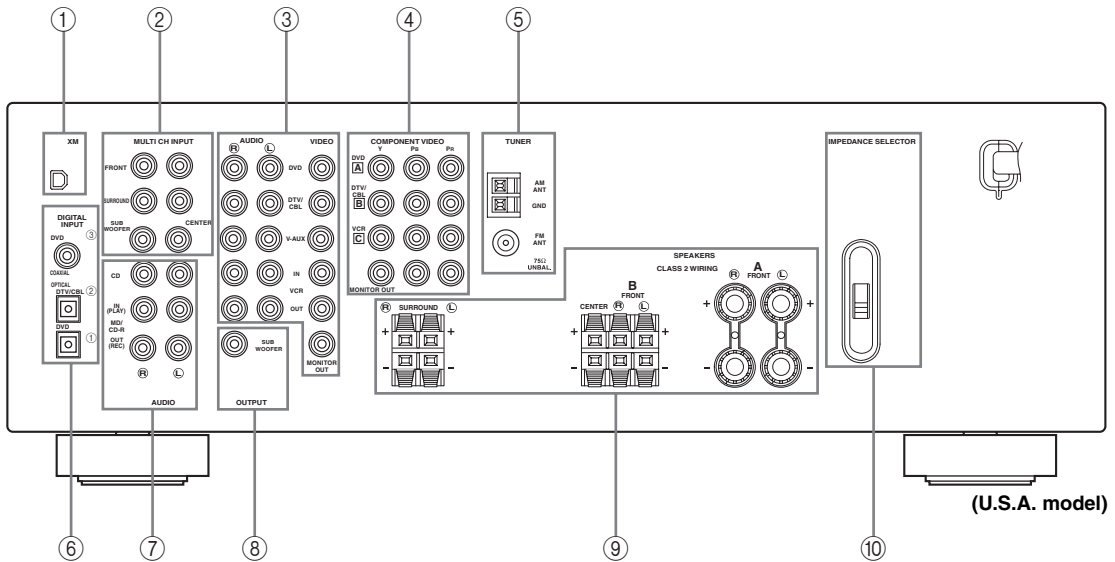

① **XM jack (U.S.A. model only)**

See page 41 for connection information.

② **MULTI CH INPUT jacks**

See page 16 for connection information.

③ **Video component jacks**

See page 14 for connection information.

④ **COMPONENT VIDEO jacks**

See page 16 for connection information.

⑤ **Antenna terminals**

See page 18 for connection information.

⑥ **DIGITAL INPUT jacks**

See pages 14 and 15 for connection information.

⑦ **Audio component jacks**

See page 17 for connection information.

⑧ **SUBWOOFER OUTPUT jack**

See page 12 for connection information.

⑨ **SPEAKERS terminals**

See page 11 for connection information.

⑩ **IMPEDANCE SELECTOR**

**(U.S.A. and Canada models only)**

See page 11 for details.

**VOLTAGE SELECTOR**

**(Asia and General models only)**

See page 19 for details.

# CONNECTIONS

## Placing speakers

The speaker layout below shows the standard ITU-R\* speaker setting. You can use it to enjoy CINEMA DSP and multi-channel audio sources.

\* ITU-R is the radio communication sector of the ITU (International Telecommunication Union).

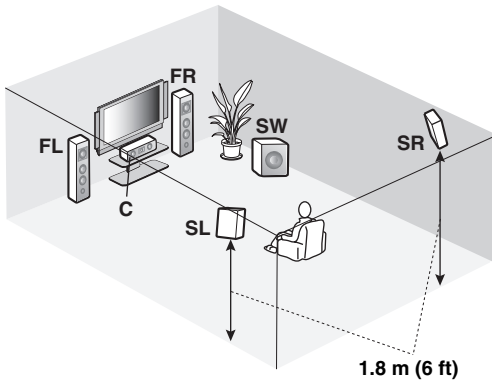
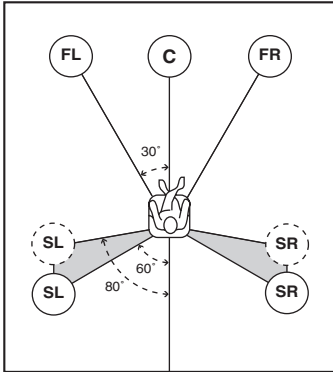

### ■ Front speakers (FL and FR)

The front speakers are used for the main source sound plus effect sounds. Place these speakers an equal distance from the ideal listening position. The distance of each speaker from each side of the video monitor should be the same.

### ■ Center speaker (C)

The center speaker is for the center channel sounds (dialog, vocals, etc.). If for some reason it is not practical to use a center speaker, you can do without it. Best results, however, are obtained with the full system. Place the center speaker centrally between the front speakers and as close to the monitor as possible, such as directly over or under it.

### ■ Surround speakers (SL and SR)

The surround speakers are used for effect and surround sounds. Place these speakers behind your listening position, facing slightly inwards, about 1.8 m (6 ft) above the floor.

### ■ Subwoofer (SW)

The use of a subwoofer, such as the YAMAHA Active Servo Processing Subwoofer System, is effective not only for reinforcing bass frequencies from any or all channels, but also for high fidelity reproduction of the LFE (low-frequency effect) channel included in Dolby Digital and DTS software. The position of the subwoofer is not so critical, because low bass sounds are not highly directional. But it is better to place the subwoofer near the front speakers. Turn it slightly toward the center of the room to reduce wall reflections.

## Connecting speakers

Be sure to connect the left channel (L), right channel (R), “+” (red) and “-” (black) properly. If the connections are faulty, no sound will be heard from the speakers, and if the polarity of the speaker connections is incorrect, the sound will be unnatural and lack bass.

### CAUTION

- Use speakers with the specified impedance shown on the rear panel of this unit.
- Before connecting the speakers, make sure that this unit is turned off.
- Do not let the bare speaker wires touch each other or do not let them touch any metal part of this unit. This could damage this unit and/or speakers.
- Use magnetically shielded speakers. If this type of speakers still creates the interference with the monitor, place the speakers away from the monitor.

(U.S.A. and Canada models only)

If you are to use 6 ohm speakers, be sure to set the IMPEDANCE SELECTOR switch on the rear panel to the upper position using a straight slot screwdriver.

Switch position	Speaker	Impedance level
Upper	FRONT A or B CENTER SURROUND	The impedance of each speaker must be 6 Ω or higher.
Lower	FRONT A or B CENTER SURROUND	The impedance of each speaker must be 8 Ω or higher.

### Before connecting to the SPEAKERS terminal

A speaker cord is actually a pair of insulated cables running side by side. Cables are colored or shaped differently, perhaps with a stripe, groove or ridges. Connect the striped (grooved, etc.) cable to the “+” (red) terminals of this unit and your speaker. Connect the plain cable to the “-” (black) terminals.

Remove approximately 10 mm (3/8”) of insulation from the end of each speaker cable and then twist the bare wires of the cable together to prevent short circuits.

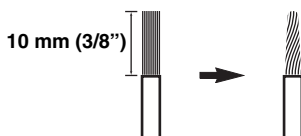

### Connecting to the FRONT A SPEAKERS terminals

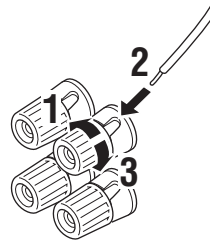

Red: positive (+)  
Black: negative (-)

1 Loosen the knob.

2 Insert the bare end of the speaker wire into the hole on the terminal.

3 Tighten the knob to secure the wire.

### Connecting the banana plug (except U.K., Europe, Korea and Asia models)

The banana plug is a single-pole electrical connector widely used to terminate speaker cables.

First, tighten the knob and then insert the banana plug connector into the end of the corresponding terminal.

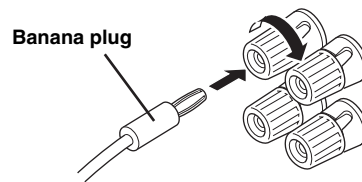

### Connecting to the FRONT B, CENTER, and SURROUND SPEAKERS terminals

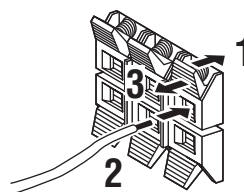

Red: positive (+)  
Black: negative (-)

1 Press down the tab.

2 Insert the bare end of the speaker wire into the hole on the terminal.

3 Release the tab to secure the wire.

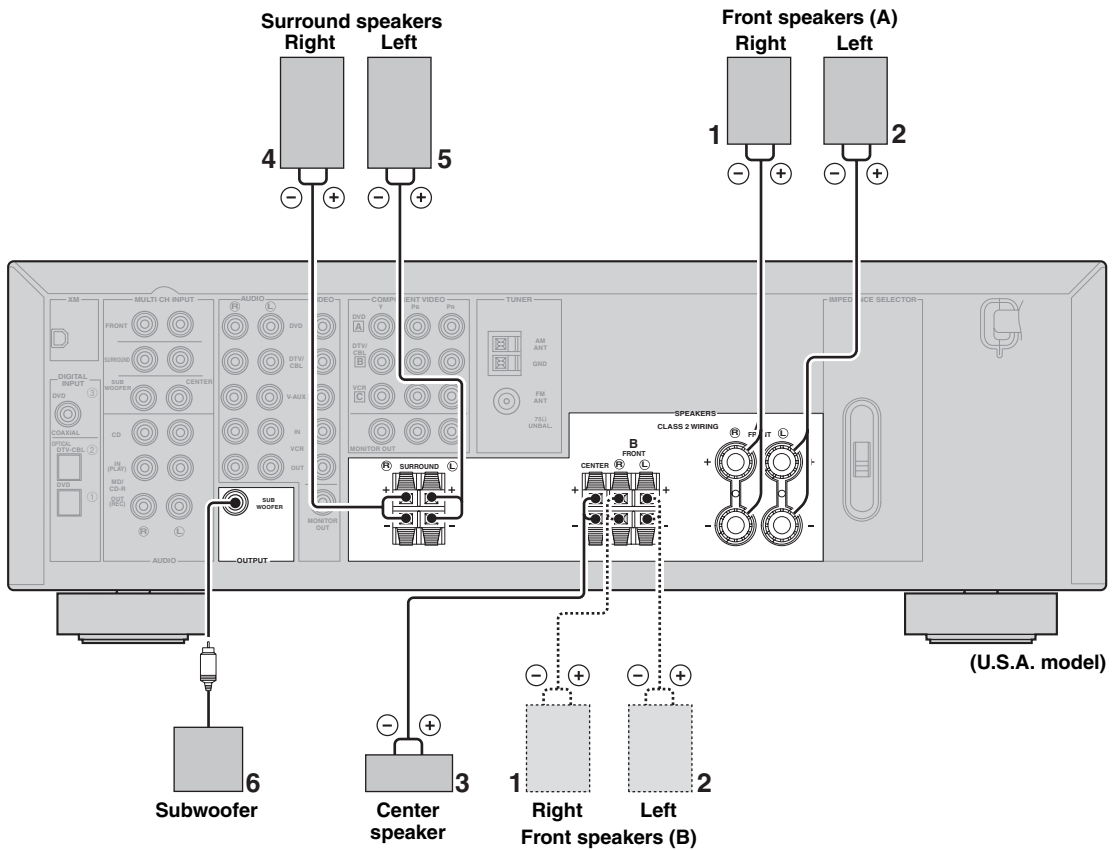

■ **FRONT terminals**

Connect one or two speaker systems (1, 2) to these terminals. If you use only one front speaker system, connect it to the FRONT A terminals.

■ **CENTER terminals**

Connect a center speaker (3) to these terminals.

■ **SURROUND terminals**

Connect surround speakers (4, 5) to these terminals.

■ **SUBWOOFER OUTPUT jack**

Connect a subwoofer with built-in amplifier (6) (such as the YAMAHA Active Servo Processing Subwoofer System) to this jack.

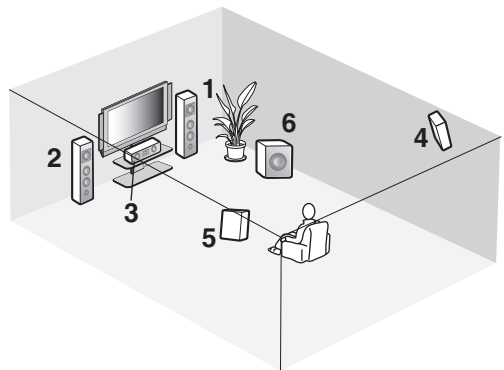

Speaker layout



## Information on jacks and cable plugs

### Audio jacks and cable plugs

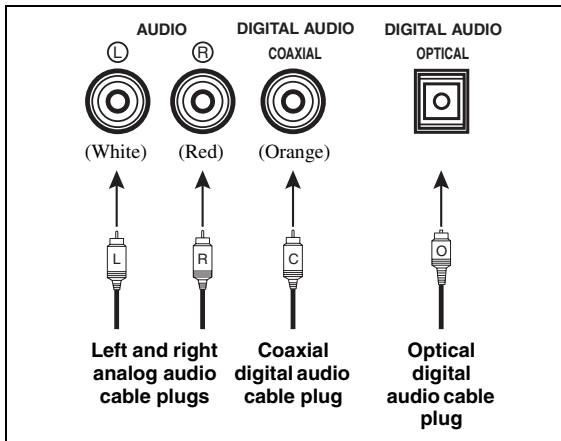

### Video jacks and cable plugs

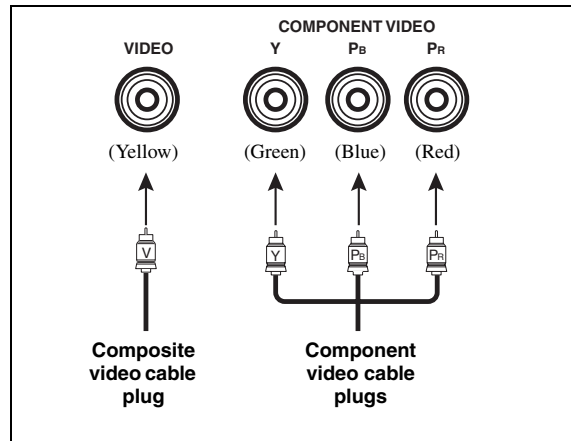

#### Audio jacks

This unit has three types of audio jacks (analog audio, digital audio coaxial, and digital audio optical). Connection depends on the availability of audio jacks on your other components.

#### AUDIO jacks

For conventional analog audio signals transmitted via left and right analog audio cables. Connect red plugs to the right jacks and white plugs to the left jacks.

#### DIGITAL AUDIO COAXIAL jacks

For digital audio signals transmitted via coaxial digital audio cables.

#### DIGITAL AUDIO OPTICAL jacks

For digital audio signals transmitted via optical digital audio cables.

#### Notes

- You can use the digital jacks to input PCM, Dolby Digital and DTS bitstreams. When you connect components to both the COAXIAL and OPTICAL jacks, priority is given to the signals input at the COAXIAL jack. All digital input jacks are compatible with 96-kHz sampling digital signals.
- This unit handles digital and analog signals independently. Thus audio signals input at the analog jacks are output only at the analog AUDIO OUT (REC) jacks.
- Pull out the cap from the optical jack before you connect the fiber optic cable. Do not discard the cap. When you are not using the optical jack, be sure to put the cap back in place. This cap protects the jack from dust.



#### Video jacks

This unit has two types of video jacks (composite video, and component video). Connection depends on the availability of input jacks on your video monitor.

#### VIDEO jacks

For conventional composite video signals transmitted via composite video cables.

#### COMPONENT VIDEO jacks

For component signals, separated into the luminance (Y) and chrominance (Pb, Pr) video signals transmitted on separate wires of component video cables.

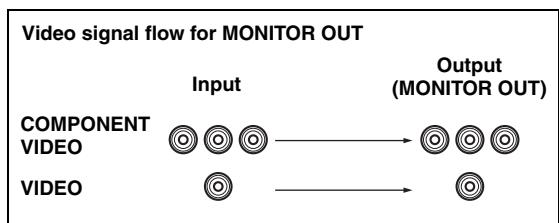

## Connecting video components

### ■ Connecting a video monitor

Connect the video input jack of your video monitor to the MONITOR OUT jack.

### ■ Connecting a DVD player/cable TV/satellite tuner

Connect the coaxial digital audio signal output jack of your DVD player to the DIGITAL INPUT DVD COAXIAL jack and connect the video signal output jack of the component to the DVD VIDEO jack of this unit. Connect the optical digital audio signal output jack of your cable TV or satellite tuner to the DIGITAL INPUT DTV/CBL jack and connect the video signal output jack of the component to the DTV/CBL VIDEO jack of this unit.



- Use the AUDIO jacks of this unit for a video component which does not have optical digital output jack. To enjoy the surround sound, use the sound field program selector buttons on the remote control (see page 30).
- If your DVD player does not have a coaxial digital output jack but has an optical cable, connect the jack to the DIGITAL INPUT DVD OPTICAL.
- You can also connect a video monitor, DVD player, digital TV, and cable TV to this unit using the COMPONENT VIDEO connections (see page 16).

### ■ Connecting a DVD recorder/VCR

Connect the audio signal input jacks of your video component to the VCR AUDIO OUT jacks of this unit. Then connect the video signal input jack of the video component to the VCR VIDEO OUT jack of this unit for picture recording.

Connect the audio signal output jacks of your component to the VCR AUDIO IN jacks of this unit. Then connect the video signal output jack of the component to the VCR VIDEO IN jack of this unit to play a source from your recording component.

#### Notes

- Once you have connected a recording component to this unit, keep the component turned on while using this unit. If the power is turned off, this unit may distort the sound from other components.
- Be sure to connect your video source components in the same way you connect your video monitor to this unit. For example, if you connect your video monitor to this unit using a VIDEO connection, connect your video source components to this unit using the VIDEO connections.

### ■ Connecting another video component

Connect the video signal output jack of your component to the V-AUX VIDEO jack of this unit.

Connect the audio signal output jacks of the component to the V-AUX AUDIO jacks of this unit.

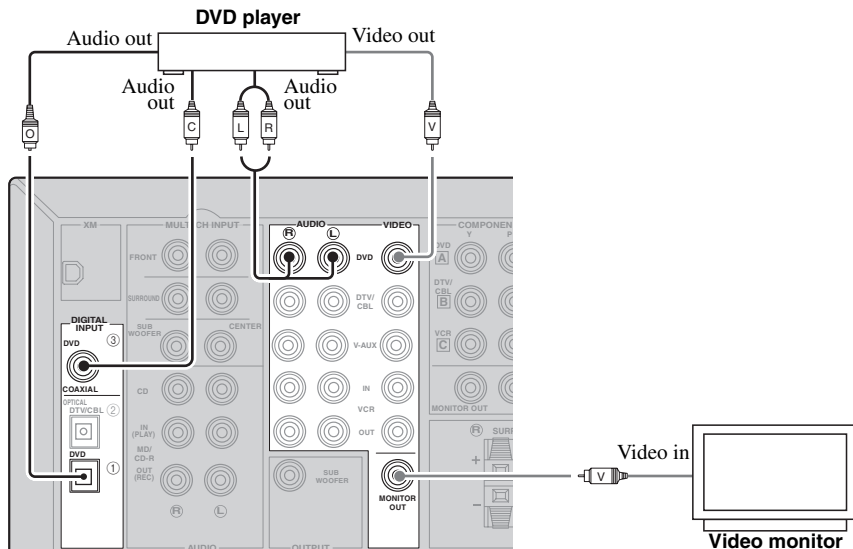

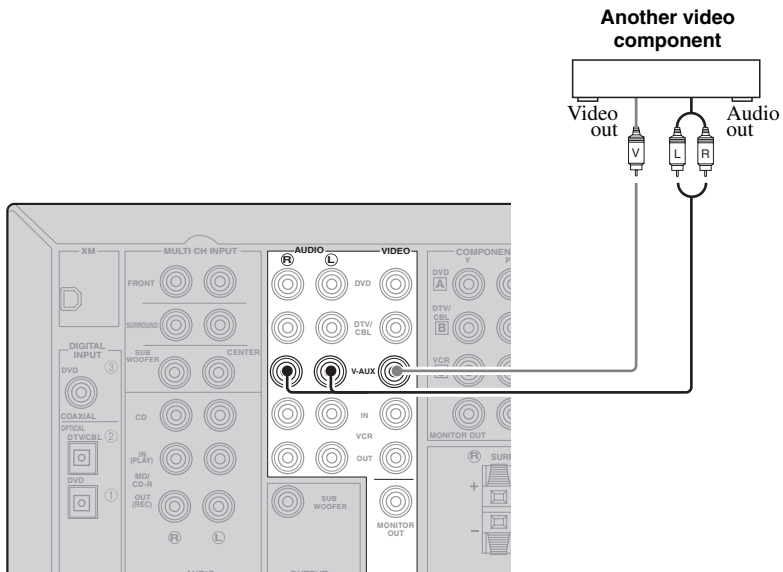
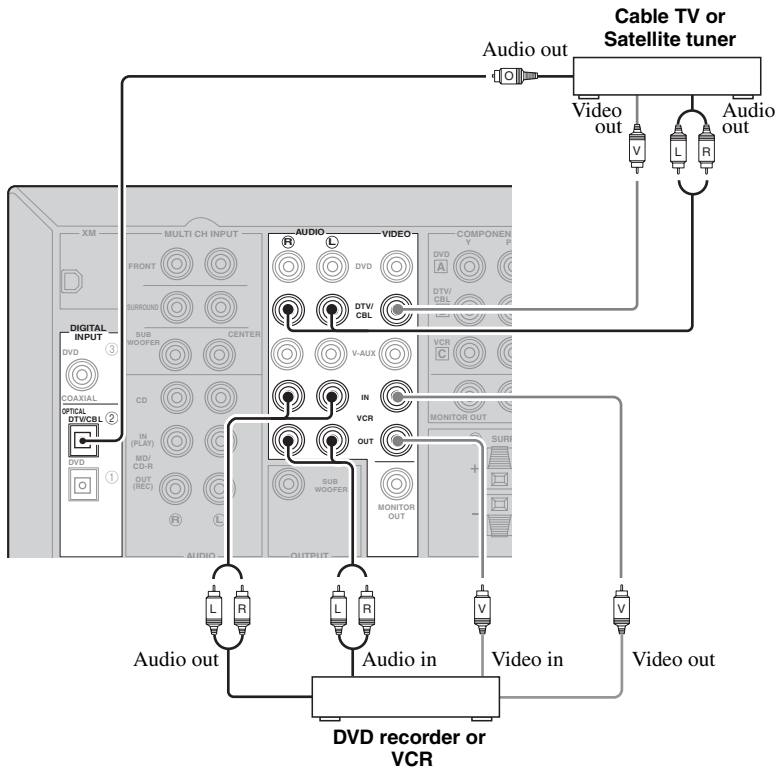

### ■ Connecting to the COMPONENT VIDEO jacks

You can enjoy high-quality pictures by connecting your video monitor and video source components to this unit using COMPONENT VIDEO connections.

**Note**

Be sure to connect your video source components in the same way you connect your video monitor to this unit. For example, if you connect your video monitor to this unit using a COMPONENT VIDEO connection, connect your video source components to this unit using the COMPONENT VIDEO connection.

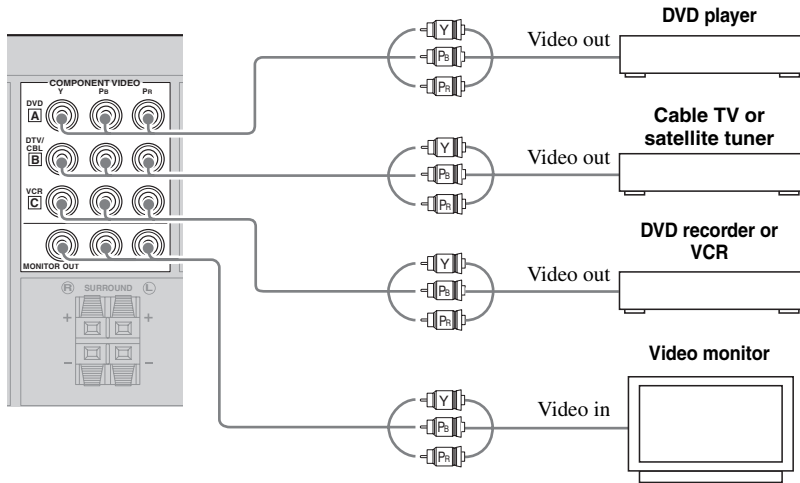

### ■ Connecting to the MULTI CH INPUT jacks

This unit is equipped with 6 additional input jacks (FRONT L/R, CENTER, SURROUND L/R and SUBWOOFER) for discrete multi-channel input from a multi-format player, external decoder or sound processor. Connect the output jacks on your multi-format player or external decoder to the MULTI CH INPUT jacks. Be sure to match the left and right channels.

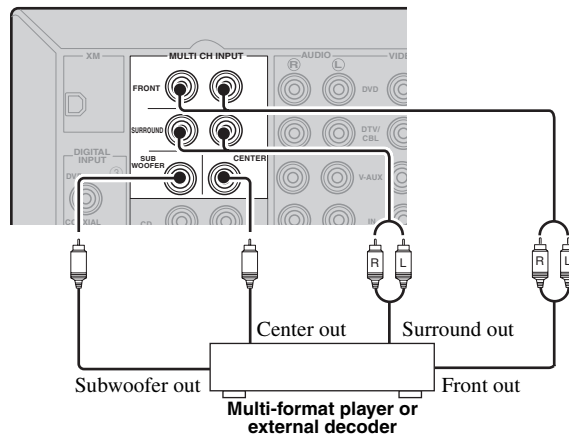

**Notes**

- When you select the component connected to the MULTI CH INPUT jacks as the input source (see page 25), this unit automatically turns off the digital sound field processor, and you cannot select sound field programs.
- This unit does not redirect signals input at the MULTI CH INPUT jacks to accommodate for missing speakers. We recommend that you connect a 5.1-channel speaker system before using this feature.
- When headphones are used, signals are output only from the front left and right channels.

## Connecting audio components

### ■ Connecting a CD player

Connect the output jacks of your CD player to the CD jacks of this unit.



To make a digital connection to a CD player, select the corresponding setting for DIGITAL INPUT jacks in "INPUT ASSIGN" (see page 55).

### ■ Connecting a CD recorder/MD recorder

Connect the input jacks of your CD recorder or MD recorder to the MD/CD-R OUT (REC) jacks.

Connect the output jacks of your CD recorder or MD recorder to the MD/CD-R IN (PLAY) jacks to play a source from your recording component.

#### Note

Once you have connected a recording component to this unit, keep the component turned on while using this unit. If the component is turned off, this unit may distort the sound from other components.

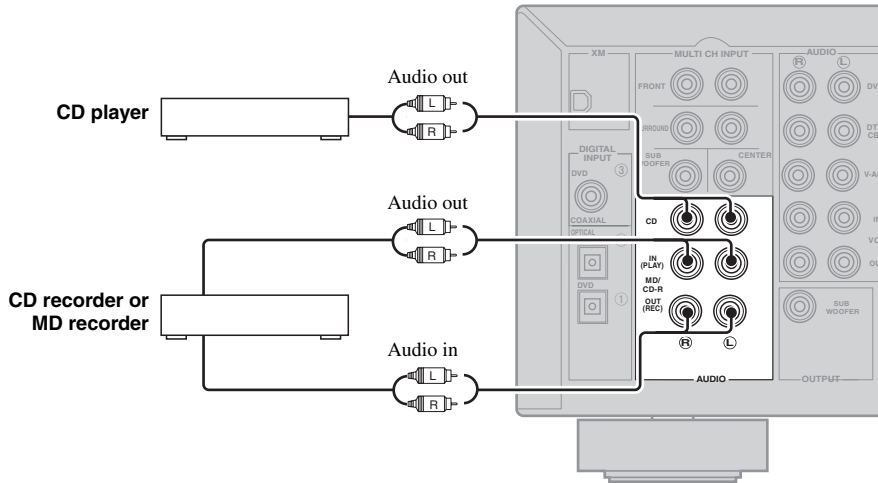

## Connecting the FM and AM antennas

Both FM and AM indoor antennas are supplied with this unit. In general, these antennas should provide sufficient signal strength. Connect each antenna correctly to the designated terminals.

### Notes

- The AM loop antenna should be placed away from this unit.
- A properly installed outdoor antenna provides clearer reception than an indoor one. If you experience poor reception quality, install an outdoor antenna. Consult the nearest authorized YAMAHA dealer or service center about outdoor antennas.
- The AM loop antenna should always be connected, even if an outdoor AM antenna is connected to this unit.

### Outdoor AM antenna

Use a 5 to 10 m (16 to 32 ft) of vinyl-covered wire extended outdoors from a window.

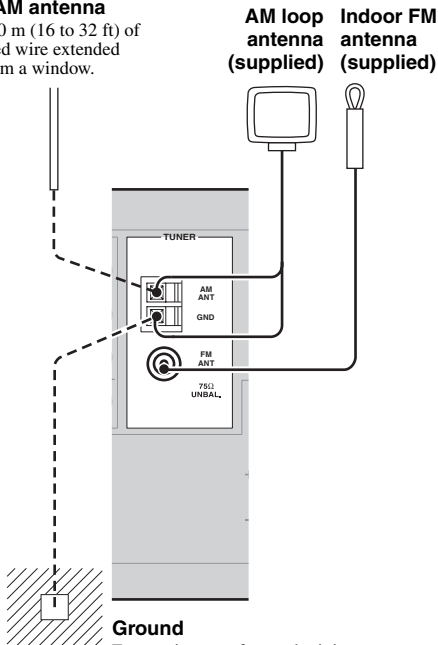

For maximum safety and minimum interference, connect the antenna GND terminal to a good earth ground. A good earth ground is a metal stake driven into moist earth.

### ■ Connecting the AM loop antenna

**1** Set up the AM loop antenna.

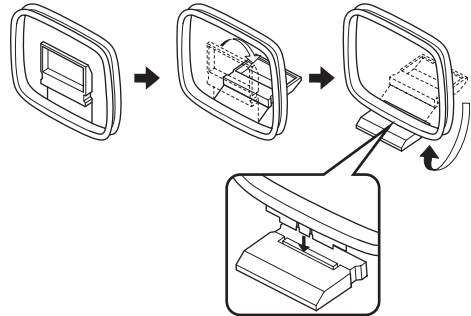

**2** Press down the tab of the AM ANT terminal.



**3** Insert the one of the AM loop antenna lead wires into the AM ANT terminal.

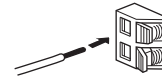

**4** Release the tab back to secure the wire.



**5** Repeat steps 2 through 4 to connect the other lead wire to the GND terminal.

Once you have properly connected the AM loop antenna to this unit, orient the AM loop antenna for the best reception when you tune into AM stations.



## Connecting the power cable

Once all connections are complete, plug the power cable into the AC wall outlet.

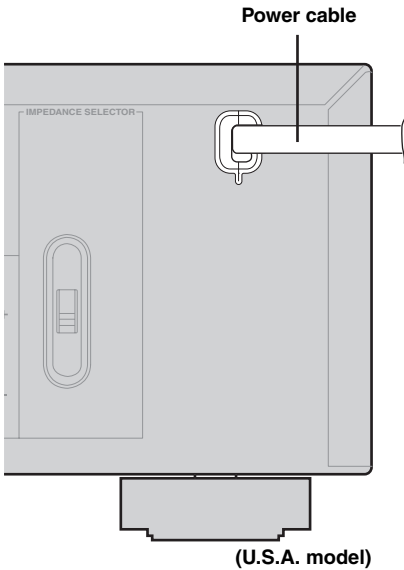

### CAUTION

#### IMPEDANCE SELECTOR (U.S.A. and Canada models only)

Before connecting the power cable into the AC wall outlet, check that the impedance selector setting is correct.

#### VOLTAGE SELECTOR (Asia and General models only)

The VOLTAGE SELECTOR on the rear panel of this unit must be set for your local voltage BEFORE plugging the power cable into the AC wall outlet. Improper setting of the VOLTAGE SELECTOR may cause damage to this unit and create a potential fire hazard.

**Select the switch position (upper or lower) according to your local voltage using a straight slot screwdriver.**

Voltages are 110-120/220-240 V AC, 50/60 Hz.

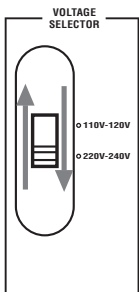

## Turning on the power

When all connections are complete, turn on this unit.

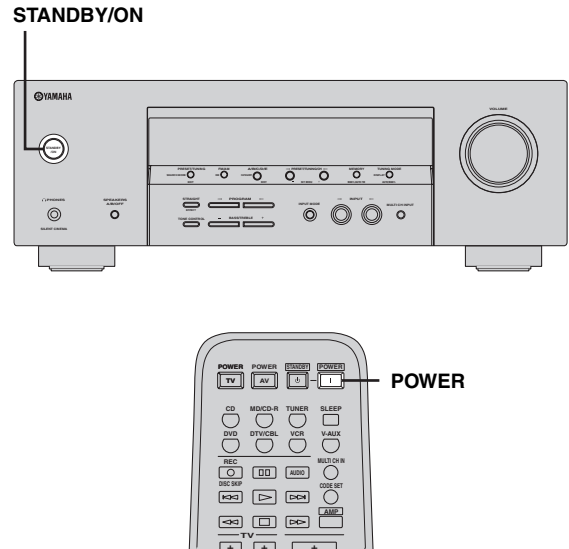

Press **STANDBY/ON** on the front panel (or **POWER** on the remote control) to turn on this unit.



Front panel

or



Remote control

Press **STANDBY/ON** on the front panel again (or press **STANDBY** on the remote control) to set this unit to the standby mode.

### Memory back-up

The memory back-up circuit prevents the stored data from being lost even if this unit is in the standby mode. However, the stored data will be lost in case the power cable is disconnected from the AC wall outlet or if the power supply is cut off for more than one week.

# SETUP

The “BASIC MENU” feature is a useful way to set up your system quickly and with minimal effort.



- If you wish to configure this unit manually using more precise adjustments, use the detailed parameters in “SOUND MENU” (see page 53).
- Altering any parameters in “SETUP” resets all parameters manually adjusted in “SOUND MENU” (see page 53).
- Initial settings are indicated in bold under each parameter.

## Using BASIC MENU

### Note

Before you begin:

- Press SPEAKERS on the front panel repeatedly (or press SPEAKERS A/B on the remote control) to select the front speakers you want to use.
- Make sure you disconnect your headphones from this unit.

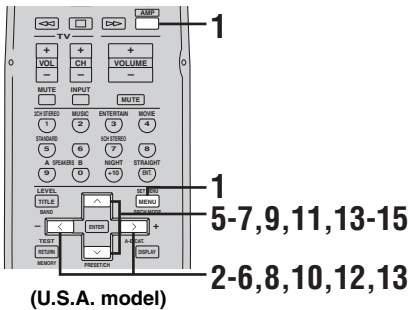

### 1 Press AMP and then SET MENU.



“BASIC MENU” appears in the front panel display. If the front panel display shows anything other than “BASIC MENU”, press SET MENU repeatedly until “BASIC MENU” appears.

### 2 Press > to enter “1 SETUP”.

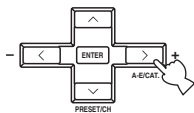

“1 SETUP” appears in the front panel display.

### 3 Press > to enter “1 SETUP”.

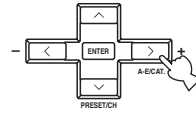

“ROOM” appears in the front panel display.

### 4 Press </> to select the desired setting.

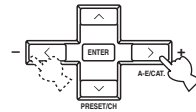

Select the size of the room where you have installed your speakers. In general, the room sizes are defined as follows:

Choices: **S, M, L**

[U.S.A. and Canada models]

S (small) 16 x 13 ft, 200 ft<sup>2</sup> (4.8 x 4.0 m, 20 m<sup>2</sup>)

M (medium) 20 x 16 ft, 300 ft<sup>2</sup> (6.3 x 5.0 m, 30 m<sup>2</sup>)

L (large) 26 x 19 ft, 450 ft<sup>2</sup> (7.9 x 5.8 m, 45 m<sup>2</sup>)

[Other models]

S (small) 3.6 x 2.8 m, 10 m<sup>2</sup>

M (medium) 4.8 x 4.0 m, 20 m<sup>2</sup>

L (large) 6.3 x 5.0 m, 30 m<sup>2</sup>

### 5 Press √ to enter “SUBWOOFER” and then press </> to select the desired setting.



Choices: **YES, NONE**

- Select “YES” if you have a subwoofer in your system.
- Select “NONE” if you do not have a subwoofer in your system.



**6** Press  $\nabla$  to confirm your selection and then press  $\langle / \rangle$  to select the number of speakers connected to this unit.



Choice	Display	Speakers
2spk	<b>L</b> <b>R</b>	Front L/R
3spk	<b>L</b> <b>C</b> <b>R</b>	Front L/R, Center
4spk	<b>L</b> <b>R</b> <b>SL</b> <b>SR</b>	Front L/R, Surround L/R
5spk	<b>L</b> <b>C</b> <b>R</b> <b>SL</b> <b>SR</b>	Front L/R, Center, Surround L/R

**7** Press  $\nabla$  to confirm your selection.

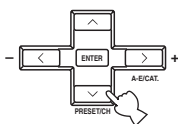

“>SET CANCEL” appears in front panel display.

**8** Press  $\langle / \rangle$  to select the desired setting.

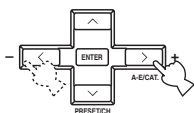

Choices: **SET**, **CANCEL**

- Select “SET” to apply the settings you made.
- Select “CANCEL” to cancel the setup procedure without making any changes.



You can also press SET MENU repeatedly to cancel the setup procedure.

**9** Press  $\nabla$  to confirm your selection.

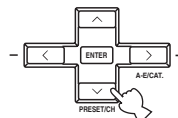

If you selected “SET” in the previous step, you will hear a test tone from each speaker in turn.

“CHECK:TestTone” appears in the front panel display for a few seconds and then “CHECK OK?” appears in the front panel display.



The indicator of the speaker currently outputting the test tone flashes in the front panel display.

**10** Press  $\langle / \rangle$  to select the desired setting.

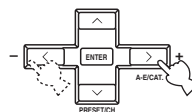

Choices: **YES**, **NO**

- Select “YES” to complete the setup procedure if the test tone levels from each speaker were satisfactory.
- Select “NO” to proceed to the speaker level adjustment menu to balance the output level of each speaker.

**11** Press  $\nabla$  to confirm your selection.

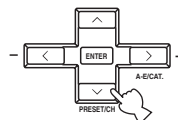

- If you selected “YES” in the previous step, the setup procedure is completed and the display returns to the “BASIC MENU”.
- If you selected “NO” in the previous step, the speaker level adjustment display appears in the front panel display.

**12** Press  $\langle / \rangle$  to adjust the balance between the front left and right speakers.

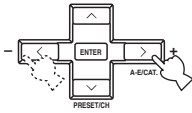

**13** Press  $\vee / \wedge$  to select a speaker and then  $\langle / \rangle$  to adjust the balance.

Press  $\rangle$  to increase the value.  
Press  $\langle$  to decrease the value.

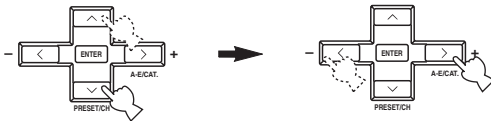

- Select “C” to adjust the balance between the front left and center speakers.
- Select “SL” to adjust the balance between the front left and surround left speakers.
- Select “SR” to adjust the balance between the surround left and surround right speakers.
- Select “SWFR” to adjust the balance between the front left speaker and the subwoofer.

**14** To confirm the settings, press  $\vee / \wedge$  repeatedly until “2 SP LEVEL” appears in the front panel display.

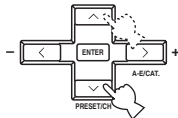

**15** Press  $\vee$  repeatedly until the menu disappears.

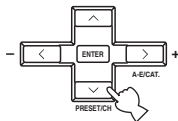

# PLAYBACK

## CAUTION

Extreme caution should be exercised when you play back CDs encoded in DTS. If you play back a CD encoded in DTS on a DTS-incompatible CD player, you will only hear some unwanted noise that may damage your speakers. Check whether your CD player supports CDs encoded in DTS. Also, check the sound output level of your CD player before you play back a CD encoded in DTS.

## Basic operations

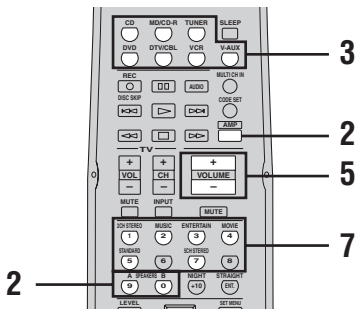
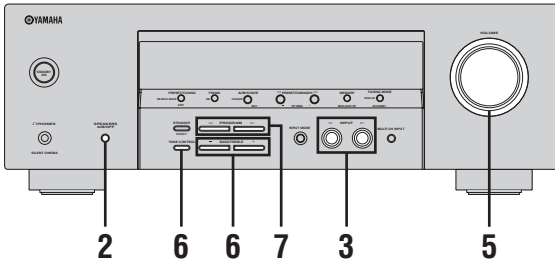

**1** Turn on the video monitor connected to this unit.

**2** Press **SPEAKERS** on the front panel repeatedly (or press **AMP** and then **SPEAKERS A/B** on the remote control) to select the front speakers you want to use.

The respective speaker indicators lights up in the front panel display.

SPEAKERS  
A/B/OFF



Front panel

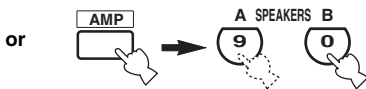

Remote control

**3** Press **INPUT**  $\triangleleft$ / $\triangleright$  on the front panel repeatedly (or press one of the input selector buttons on the remote control) to select the desired input source.

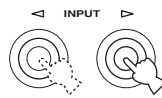

Front panel

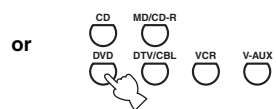

Remote control

The name of the currently selected input source appears in the front panel display for a few seconds.

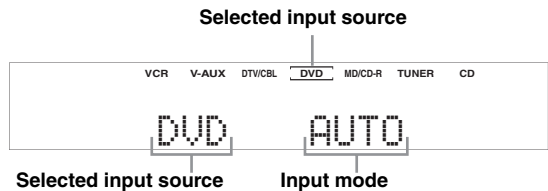

### Note

If you are to select an input source connected via digital connections, set "INPUT MODE" to "AUTO" or "DTS" (see page 26).

**4** Start playback on the selected component or select a broadcast station.

- When a multi-channel signal (Dolby Digital or DTS) is input digitally, this unit decodes the signal and reproduces surround sound.
- Refer to the operating instructions for the source component.
- See page 35 for details about FM/AM tuning instructions.
- See page 41 for details about XM Satellite Radio tuning instructions.

- 5 Rotate **VOLUME** on the front panel (or press **VOLUME +/-** on the remote control) to adjust the volume to the desired output level.

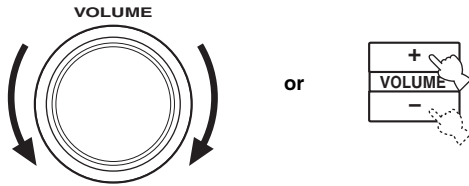

#### Note

If you connected a recording component to the VCR OUT, or MD/CD-R OUT (REC) jacks, and you notice distortion or low volume during playback from other components, try turning on the recording component.

- 6 Press **TONE CONTROL** on the front panel repeatedly to select “**BASS**” or “**TREBLE**” and then press **BASS/TREBLE +/-** to adjust the corresponding frequency response level.



- Select “**BASS**” to adjust the low-frequency response.
- Select “**TREBLE**” to adjust the high-frequency response.

#### Notes

- Speaker and headphone adjustments are stored independently.
- When “**TONE BYPASS**” (see page 55) is set to “**AUTO**”, and “**BASS**” and “**TREBLE**” are set to 0 dB, audio output automatically bypasses the tone control circuitry of this unit.
- If you increase or decrease the high-frequency or low-frequency sound to an extreme level, the tonal quality of the surround speakers may not match that of the front left and right speakers.
- **TONE CONTROL** is not effective when the component connected to the **MULTI CH INPUT** jacks is selected as the input source (see page 25).

- 7 Press **PROGRAM** </> on the front panel repeatedly (or press one of the sound field program selector buttons on the remote control repeatedly) to select the desired sound field program.

The name of the selected sound field program appears in the front panel display.

See page 31 for details about sound field programs.

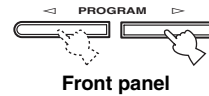

Front panel

or

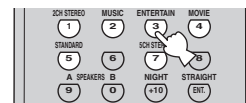

Remote control



The Roxy Thtr

Currently selected  
surround field program

#### Notes

- Choose a sound field program based on your listening preference, not merely on the name of the program.
- When you select an input source, this unit automatically selects the last sound field program used with the corresponding input source.
- Sound field programs cannot be selected when the component connected to the **MULTI CH INPUT** jacks is selected as the input source (see page 25).
- When sampling frequencies higher than 48 kHz are input, this unit is automatically set to the “**STEREO**” mode.
- To display information about the currently selected input source in the front panel display, see page 28 for details.

## Additional operations

### ■ Listening with headphones using SILENT CINEMA

SILENT CINEMA allows you to enjoy multi-channel music or movie sound, including Dolby Digital and DTS sources, through ordinary headphones. SILENT CINEMA activates automatically whenever you connect headphones to the PHONES jack while listening to CINEMA DSP or HiFi DSP sound field programs (see page 31). When activated, the SILENT CINEMA indicator lights up in the front panel display.

#### Notes

- SILENT CINEMA does not activate when the component connected to the MULTI CH INPUT jacks is selected as the input source.
- SILENT CINEMA is not effective when “2CH STEREO” (see page 31) is selected or when this unit is in the “STRAIGHT” mode (see page 33).
- The sound from the LFE channel will be mixed and output from the headphones.

### ■ Muting the audio output

Press **MUTE** on the remote control to mute the audio output.

Press **MUTE** again to resume the audio output.



- You can also rotate **VOLUME** on the front panel or **VOLUME +/-** on the remote control to resume the audio output.
- You can adjust the muting level by using “AUDIO MUTE” in “OPTION MENU” (see page 56).
- The **MUTE** indicator flashes in the front panel display when the audio output is muted and disappears from the front panel display when the audio output is resumed.

#### Note

If you change the input source or the sound field program while the audio output is being muted, this unit resumes the audio output.

### ■ Selecting the MULTI CH INPUT component as the input source

Use this feature to select the component connected to the MULTI CH INPUT jacks (see page 16) as the input source.

Press **MULTI CH INPUT** on the front panel (or **MULTI CH IN** on the remote control) so that “MULTI CH INPUT” appears in the front panel display.

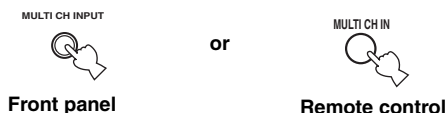

#### Note

When “MULTI CH INPUT” is shown in the front panel display, no other source can be played. To select another input source with **INPUT </>** on the front panel (or one of the input selector buttons on the remote control), press **MULTI CH INPUT** (or **MULTI CH IN** on the remote control) so that “MULTI CH INPUT” disappears from the front panel display.

### ■ Using the night listening mode

The night listening mode is designed to improve listenability at lower volumes or at night.

Press **AMP** on the remote control and then press **NIGHT** to select “NIGHT ON”.



When a night listening mode is selected, the **NIGHT** indicator lights up in the front panel display.

#### Notes

- You can use the night listening mode with any of the sound field programs.
- The night listening mode may vary in effectiveness depending on the input source and the surround sound settings you use.

## ■ Selecting the input modes

This unit comes with a variety of input jacks. Do the following to select the type of input signals you want to use.



- We recommend setting “INPUT MODE” to “AUTO” in most cases.
- You can adjust the default input mode of this unit by using the “INPUT MODE” parameter in “INPUT MENU” (see page 55).

### Notes

- To play DTS-encoded CDs when using a digital audio connection, be sure to set “INPUT MODE” to “DTS”.
- Depending on the player, DTS decoding may not be performed correctly even if you make a digital connection between this unit and the player.

## 1 Press INPUT ◀/▶ on the front panel to select the desired input source.

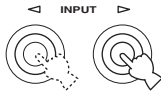

## 2 Press INPUT MODE on the front panel repeatedly to select the desired input mode.

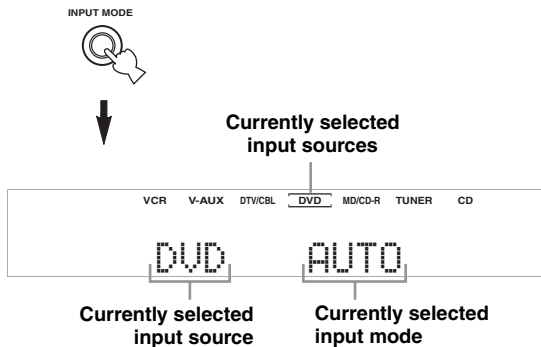

AUTO	Automatically selects input signals in the following order: 1) Digital signals 2) Analog signals
DTS	Selects only digital signals encoded in DTS. If no DTS signals are input, no sound is output.
ANALOG	Selects only analog signals. If no analog signals are input, no sound is output.

### Note

When “INPUT MODE” is set to “AUTO”, this unit automatically switches to the appropriate decoder if a Dolby Digital or DTS signal is detected.

## ■ Adjusting speaker levels during playback

You can adjust the output level of each speaker while listening to a music source. This is also possible when playing sources input at the MULTI CH INPUT jacks.

## 1 Press AMP on the remote control and then press LEVEL repeatedly to select the speaker you want to adjust.



- Select “FRONT L” to adjust the front left speaker output level.
- Select “CENTER” to adjust the center speaker output level.
- Select “FRONT R” to adjust the front right speaker output level.
- Select “SUR. R” to adjust the surround right speaker output level.
- Select “SUR. L” to adjust the surround left speaker output level.
- Select “SWFR” to adjust the subwoofer output level.



Once you press LEVEL on the remote control, you can also select the speaker by pressing ^ / ∨.

## 2 Press </> on the remote control to adjust the speaker output level.

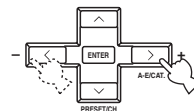

The control range is from +10 dB to -10 dB for the center and surround speakers, and from 0 dB to -20 dB for the front speakers and subwoofer.

### Notes

- This operation will override the level adjustments made in “SETUP” (see page 20).
- You cannot adjust speaker levels if “SPEAKER SET” in “SOUND MENU” (see page 53) is set to “NONE”.
- You cannot adjust the subwoofer level if “BASS” in “SPEAKER SET” (see page 53) in the set menu is set to “FRNT”.
- If you use LEVEL to adjust speaker levels, the speaker levels you previously set with the test tone will also change.
- If you select “SETUP” (see page 20) and then select “SET”, speaker levels change in response to any changes you make in “SETUP”.

## ■ Using the test tone

Use the test tone to set speaker levels so that the volume from each speaker is identical when heard from your listening position. This is also possible when playing sources input at the MULTI CH INPUT jacks.

### 1 Press AMP on the remote control and then press TEST.

The unit will output a test tone.



### 2 Press $\wedge$ / $\vee$ repeatedly to select a speaker to adjust.

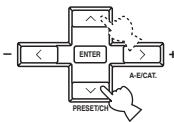

- Select “TEST LEFT” to adjust the front left speaker output level.
- Select “TEST CENTER” to adjust the center speaker output level.
- Select “TEST RIGHT” to adjust the front right speaker output level.
- Select “TEST SUR.R” to adjust the surround right speaker output level.
- Select “TEST SUR.L” to adjust the surround left speaker output level.
- Select “TEST SUBWOOFER” to adjust the subwoofer output level.

### 3 Press $\langle / \rangle$ on the remote control to adjust the speaker output level.

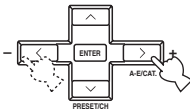

The control range is from +10 dB to -10 dB for the center and surround speakers, and from 0 dB to -20 dB for the front speakers and subwoofer.

### 4 Press TEST on the remote control when you have completed your adjustment.

The test tone halts.



## Notes

- You cannot use the test tone if headphones are connected to the PHONES jack. Remove the headphones from the PHONES jack.
- This operation will override the level adjustments made in “SETUP” (see page 20).
- You cannot adjust speaker levels if “SPEAKER SET” in “SOUND MENU” (see page 53) is set to “NONE”.
- You cannot adjust the subwoofer level if “BASS” in “SPEAKER SET” (see page 53) in the set menu is set to “FRNT”.
- If you use TEST to adjust speaker levels, the speaker levels you previously adjust during playback will also change.
- If you select “SETUP” (see page 20) and then select “SET”, speaker levels change in response to any changes you make in “SETUP”.



Depending on the source, the speaker levels set with the test tone may not be to your liking. In this case, adjust the speaker levels while listening to the source.

## ■ Displaying information about the input source

You can display the format, sampling frequency, channel and bit rate of the current input signal.

- 1 Press one of the input selector buttons on the remote control to select the desired input source.

- 2 Press AMP on the remote control and then press STRAIGHT to select "STRAIGHT".



- 3 Press  $\wedge$  /  $\vee$  to display the following information about the input source.

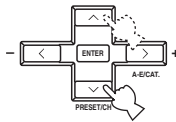

## FORMAT

Signal format display. When this unit cannot detect a digital signal, it automatically switches to analog input.

Display status: Analog, Digital, Dolby Digital, DTS, PCM, Unknown Digital

### Note

"Unknown Digital" appears when this unit detects any undecodable digital signal.

## CHANNEL

Number of source channels in the input signal (front/surround/LFE). For example, a multi-channel soundtrack with 3 front channels, 2 surround channels and LFE, is displayed as "3/2/LFE".

## SAMPLING

Sampling frequency.

Display status: 32kHz, 44.1kHz, 48kHz, 64kHz, 88.2kHz, 96kHz

## BITRATE

Bit rate.



When you are displaying information about the input source, this unit is in the "STRAIGHT" mode (see page 33). To turn back the sound field program on, press STRAIGHT again.



## ■ Using the sleep timer

Use this feature to automatically set this unit to the standby mode after a certain amount of time. The sleep timer is useful when you are going to sleep while this unit is playing or recording a source.

### Press SLEEP on the remote control repeatedly to set the amount of time.

Each time you press SLEEP, the front panel display changes as shown below.

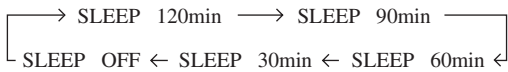

The SLEEP indicator flashes while you are switching the amount of time for the sleep timer. Once the sleep timer is set, the SLEEP indicator lights up in the front panel display, and the display returns to the selected sound field program.



Flashes



Lights up

To cancel the sleep timer, press SLEEP on the remote control repeatedly until “SLEEP OFF” appears in the front panel display.

The SLEEP indicator turns off and “SLEEP OFF” disappears after a few seconds.



The sleep timer setting can also be canceled by pressing STANDBY/ON on the front panel (or STANDBY on the remote control) to set this unit to the standby mode.

## ■ Playing video sources in the background

You can combine a video image from a video source with sound from an audio source. For example, you can enjoy listening to classical music while viewing beautiful scenery from the video source on the video monitor.

### Press the input selector buttons on the remote control to select a video source and then an audio source.

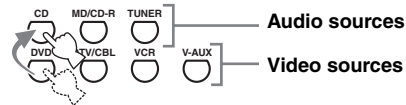

#### Note

If you want to enjoy an audio source input at the MULTI CH INPUT jacks together with a video source, first select the video source and then press MULTI CH INPUT on the front panel (or MULTI CH IN on the remote control) to select the component connected to the MULTI CH INPUT jacks as the input source (see page 25).

# SOUND FIELD PROGRAMS

This unit is equipped with a variety of precise digital decoders that allow you to enjoy multi-channel playback from almost any stereo or multi-channel sound source. This unit is also equipped with a YAMAHA digital sound field processing (DSP) chip containing several sound field programs which you can use to enhance your playback experience.

## Notes

- Choose a sound field program based on your listening preference, not merely on the name of the program.
- When you select an input source, this unit automatically selects the last sound field program used with the corresponding input source.
- Sound field programs cannot be selected when the component connected to the MULTI CH INPUT jacks is selected as the input source (see page 25).
- When sampling frequencies higher than 48 kHz are input, this unit is automatically set to the “STEREO” mode.

## ■ Front panel operations

(U.S.A. model)

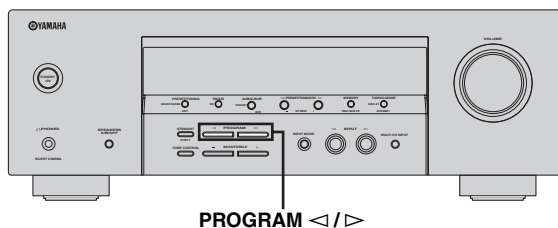

**Press PROGRAM </> on the front panel repeatedly.**

The name of the selected sound field program appears in the front panel display.

## ■ Remote control operations

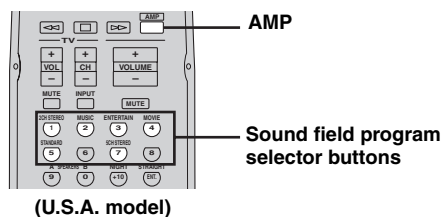

**Press AMP on the remote control and then press one of the sound field program selector buttons repeatedly.**

The name of the selected sound field program appears in the front panel display.

## Sound field program descriptions

Remote control button	Program	Features
2CH STEREO	2CH STEREO	Downmixes multi-channel sources to 2 channel or plays back 2-channel sources as they are.
	Concert Hall	HiFi DSP processing. This program produces the excitement of a live concert hall.
MUSIC	The Roxy Thtr	HiFi DSP processing. The program reproduces the dynamic rock music environment of "The Roxy Theatre", one of the hottest rock clubs in L.A. The listener's virtual seat is at the center-left of the hall.
	Game	CINEMA DSP processing. This program adds the dynamics and thrills of the three-dimensional surround sound effect.
ENTERTAIN	TV Sports	CINEMA DSP processing. This program enhances the experience of watching sports by producing the ambient sounds of the crowd and the stadium.
	Movie Spacious	CINEMA DSP processing. This program offers clear dialog with a wide sound field for movie scenes. It is ideal for any type of movie, live music and game contents.
MOVIE	Movie Dramatic	CINEMA DSP processing. This program creates a live sound field by emphasizing the dramatic scene changes of action movies and games.
	STANDARD	STANDARD
5CH STEREO	5CH STEREO	Using this program increases the listening position range. This is a sound field suitable for background music at parties.



The sound field programs are compatible with all Dolby Digital, DTS, and Dolby Surround sources. Set "INPUT MODE" to "AUTO" (see page 26) to enable this unit to automatically switch to the appropriate digital decoder according to the input signal.

### Notes

- The sound field programs of this unit are recreations of real-world acoustic environments made from precise measurements taken in the actual concert hall, music venue, movie theater, etc. Thus, you may notice variations in the strength of the reflections coming from the front, back, left and right.
- Choose a sound field program based on your listening preference, not merely on the name of the program itself.

**Enjoying 2-channel sources using the standard decoders**

Signals input from 2-channel sources can also be played back on multi-channels.

Press **AMP** on the remote control and then **STANDARD** on the remote control repeatedly to select a decoder.



You can select from the following decoders depending on the type of source you are playing and your personal preference.

STANDARD	Functions
PRO LOGIC	Dolby Pro Logic processing for any sources
PLII Movie	Dolby Pro Logic II processing for movie sources
PLII Music	Dolby Pro Logic II processing for music sources



You can also select a decoder by pressing **</>** on the remote control while the decoder type is displayed in the front panel display.

**Editing sound fields parameters**

You can enjoy good quality sound with the factory preset parameters. Although you do not have to change the initial settings, you can change some of the parameters to better suit the input source or your listening room.

**1** While listening to a source, press **AMP** on the remote control and then press **^ / v** to select the parameters.

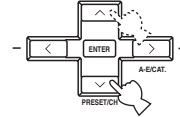

**2** Press **</>** to change parameter value.

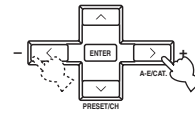

**Note**

You cannot change parameter values when “MEM. GUARD” in “OPTION MENU” is set to “ON” (see page 56).

**For 2CH STEREO:****Direct DIRECT**

Function: 2-channel stereo direct. Bypasses the decoders and DSP processors of this unit for pure hi-fi stereo sound when playing 2-channel analog sources.

Choices: **AUTO, OFF**



- The "AUTO" setting bypasses the decoders and DSP processors only when "BASS" and "TREBLE" are set to 0 dB (see page 24).
- When multi-channel signals (Dolby Digital and DTS) are input, they are downmixed to 2 channels and output from the front left and right speakers.
- The low-frequency signals input from the front left and right speakers are redirected to the subwoofer in the following cases:
  - "BASS" is set to "BOTH" (see page 54).
  - "FRONT" is set to "SML" (see page 54) and "BASS" is set to "SWFR" (see page 54).

**For PRO LOGIC II Music:****Panorama PANORAMA**

Function: Sends stereo signals to the surround speakers as well as the front speakers for a wraparound effect.

Choices: **OFF, ON**

**Dimension DIMENSION**

Function: Gradually adjusts the sound field either towards the front or towards the rear.

Control range: -3 (towards the rear) to +3 (towards the front), initial setting is STD (standard).

**Center width CT WIDTH**

Function: Adjusts the center image from all three front speakers to varying degrees. A larger value adjusts the center image towards the front left and right speakers.

Control range: 0 (center channel sound is output only from center speaker) to 7 (center channel sound is output only from front left and right speakers), initial setting is 3.

**Using Virtual CINEMA DSP**

Virtual CINEMA DSP allows you to enjoy the CINEMA DSP programs without surround speakers by creating virtual speakers.

If you set "SURR" to "NONE" (see page 54), Virtual CINEMA DSP activates automatically whenever you select a CINEMA DSP program (see page 31).

**Note**

Virtual CINEMA DSP will not activate even when "SURR" is set to "NONE" (see page 54) in the following cases:

- When "2CH STEREO" (see page 31) is selected or when this unit is in the "STRAIGHT" mode.
- When the component connected to the MULTI CH INPUT jacks is selected as the input source (see page 25).
- When headphones are connected to the PHONES jack.

**Listening to unprocessed input signals**

When this unit is in the "STRAIGHT" mode, multi-channel sources are decoded straight into the appropriate channels without any additional effect processing. 2-channel stereo sources are output from only the front left and right speakers.

- 1 Press AMP on the remote control and then STRAIGHT to select "STRAIGHT".**



- 2 To deactivate the "STRAIGHT" mode, press STRAIGHT on the remote control again so that "STRAIGHT" disappears from the front panel display.**

The sound field program is turned back on.



You can also select "STRAIGHT" by pressing STRAIGHT on the front panel.

# RECORDING

Recording adjustments and other operations are performed from the recording components. Refer to the operating instructions for those components.

## Notes

- When this unit is set to the standby mode, you cannot record between other components connected to this unit.
- The settings of TONE CONTROL (see page 24), VOLUME, speaker levels (see page 26) and the sound field programs (see page 31) do not affect recorded material.
- The source connected to the MULTI CH INPUT jacks of this unit cannot be recorded.
- Digital signals input at the DIGITAL INPUT jacks are not output at the analog AUDIO OUT (REC) jacks for recording. Therefore, if your source component is connected to provide only digital signals, you cannot record the source.
- A given input source is not output on the same OUT (REC) channel.
- Check the copyright laws in your country to record from CDs, radio, etc. Recording of copyrighted material may infringe copyright laws.
- The XM Satellite Radio signals cannot be output at the AUDIO OUT (REC) jacks.



Do a test recording before you start an actual recording.

If you play back a video source that uses scrambled or encoded signals to prevent it from being dubbed, the picture itself may be disturbed due to those signals.

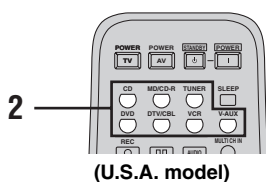
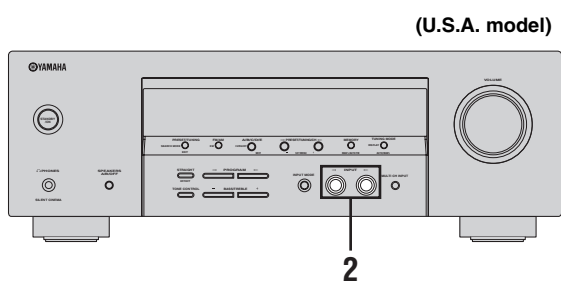

**1 Turn on all the connected components.**

**2 Press INPUT </> on the front panel repeatedly (or press one of the input selector buttons on the remote control) to select the source component you want to record from.**

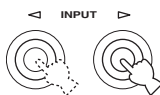

Front panel

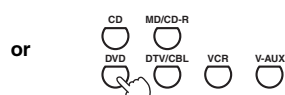

Remote control

**3 Start playback on the selected source component or select a broadcast station.**

**4 Start recording on the recording component.**

# FM/AM TUNING

There are 2 tuning methods: automatic and manual. Automatic tuning is effective when station signals are strong and there is no interference. If the signal from the station you want to select is weak, tune into it manually. You can also use the automatic and manual preset tuning features to store up to 40 stations (A1 to E8: 8 preset station numbers in each of the 5 preset station groups). Furthermore, you can recall any preset stations and exchange the assignment of two preset stations with each other.

## Automatic tuning

Automatic tuning is effective when station signals are strong and there is no interference.

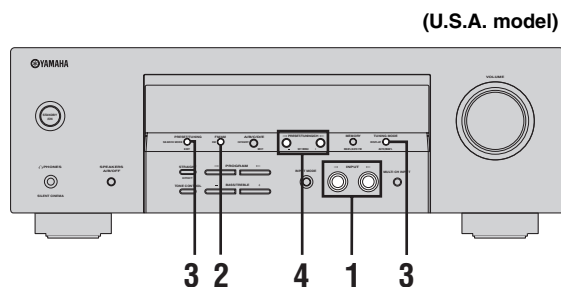

- 1 Press **INPUT**  $\triangleleft/\triangleright$  repeatedly so that **"TUNER"** is displayed in the front panel display.

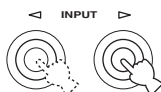

- 2 Press **FM/AM** to select the reception band (FM or AM).



- 3 Press **TUNING MODE** so that the **AUTO** indicator lights up in the front panel display.



Lights up



No colon (:)

If a colon (:) appears in the front panel display, automatic tuning is not possible. Press **PRESET/TUNING** to turn the colon (:) off.



- 4 Press **PRESET/TUNING/CH**  $\triangleleft/\triangleright$  once to begin automatic tuning.

When this unit is tuned into a station, the **TUNED** indicator lights up and the frequency of the received station is shown in the front panel display.

- Press  $\triangleright$  to tune into a higher frequency.
- Press  $\triangleleft$  to tune into a lower frequency.



Lights up

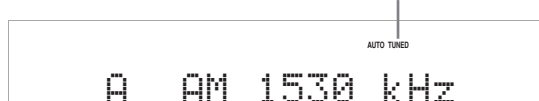

## Manual tuning

If the signal received from the station you want to select is weak, tune into it manually.

### Note

Manually tuning into an FM station automatically switches the tuner to monaural reception to increase the signal quality.

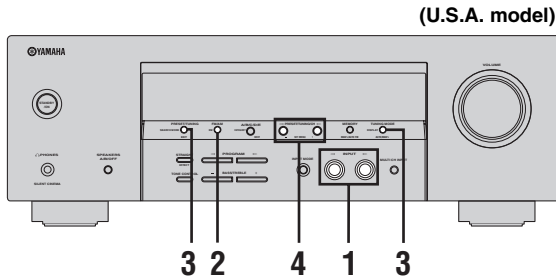

- 1 Press INPUT  $\triangleleft/\triangleright$  repeatedly so that "TUNER" is displayed in the front panel display.

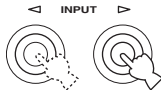

- 2 Press FM/AM to select the reception band (FM or AM).



- 3 Press TUNING MODE so that the AUTO indicator disappears from the front panel display.



A AM 1440 kHz

No colon (:)

If a colon (:) appears in the front panel display, manual tuning is not possible. Press PRESET/TUNING to turn the colon (:) off.



- 4 Press PRESET/TUNING/CH  $\triangleleft/\triangleright$  to tune into the desired station manually.

- Press  $\triangleright$  to tune into a higher frequency.
- Press  $\triangleleft$  to tune into a lower frequency.
- Hold down the button to continue searching.





## Automatic preset tuning

You can use the automatic preset tuning feature to store FM stations with strong signals up to 40 (A1 to E8: 8 preset station numbers in each of the 5 preset station groups) of those stations in order. You can then recall any preset station easily by selecting the preset station number.

(U.S.A. model)

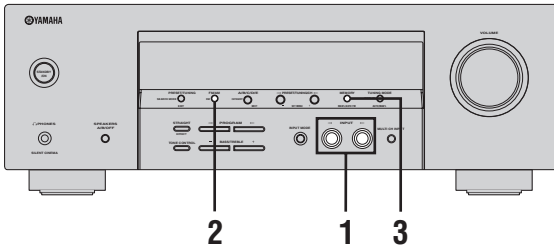

- 1 Press **INPUT**  $\triangleleft/\triangleright$  repeatedly so that **"TUNER"** is displayed in the front panel display.

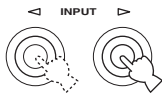

- 2 Press **FM/AM** to select **"FM"** as the reception band.



- 3 Press and hold **MEMORY** for more than 3 seconds.

The preset station number as well as the **MEMORY** and **AUTO** indicators flashes. After approximately 5 seconds, automatic presetting starts from the current frequency and proceeds toward the higher frequencies.

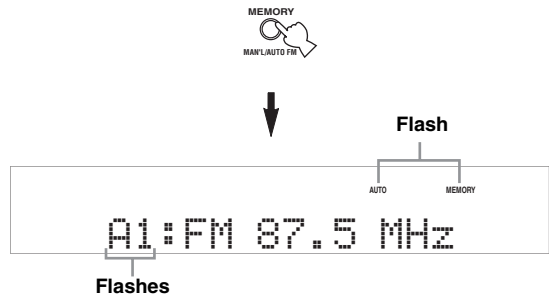

When automatic preset tuning is completed, the front panel display shows the frequency of the last preset station.



You can select the preset station group and the preset station number where the first received station will be stored by pressing A/B/C/D/E on the front panel and then **PRESET/TUNING/CH**  $\triangleleft/\triangleright$ .

### Notes

- Any stored station data existing under a preset station number is cleared when you store a new station under the same preset station number.
- If the number of received stations does not reach 40 (E8), automatic preset tuning automatically stops after searching for all the available stations.
- Only FM stations with sufficient signal strength are stored automatically by automatic preset tuning. If the station you want to store is weak in signal strength, tune into it manually and store it as described in "Manual preset tuning" on page 38.

## Manual preset tuning

You can also store up to 40 stations (A1 to E8: 8 preset station numbers in each of the 5 preset station groups) manually.

(U.S.A. model)

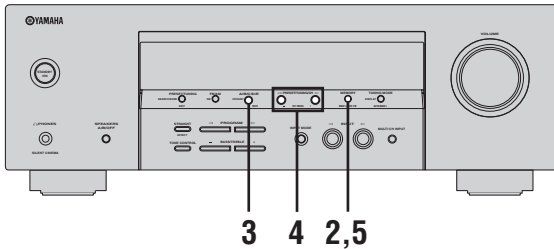

### 1 Tune into a station automatically or manually.

See pages 35 and 36 for tuning instructions.



When this unit is tuned into a station, the front panel display shows the frequency of the station received.

### 2 Press MEMORY.

The MEMORY indicator flashes in the front panel display for approximately 5 seconds.



### 3 Press A/B/C/D/E repeatedly to select a preset station group (A to E) while the MEMORY indicator is flashing.

The preset station group letter appears. Check that the colon (:) appears in the front panel display.

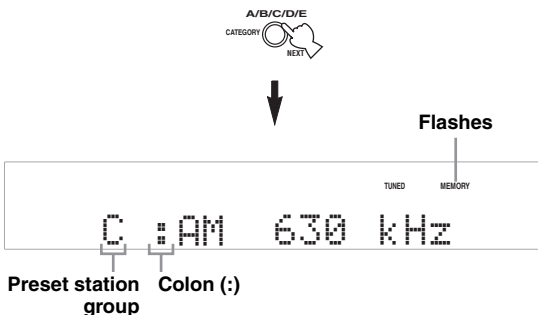

### 4 Press PRESET/TUNING/CH </> to select a preset station number (1 to 8) while the MEMORY indicator is flashing.

- Press > to select a higher preset station number.
- Press < to select a lower preset station number.

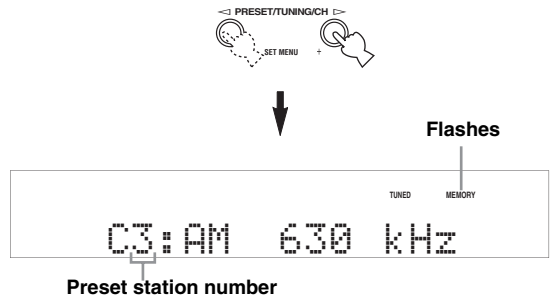

### 5 Press MEMORY while the MEMORY indicator is flashing.

The station band and frequency appear in the front panel display with the preset station group and number you have selected.

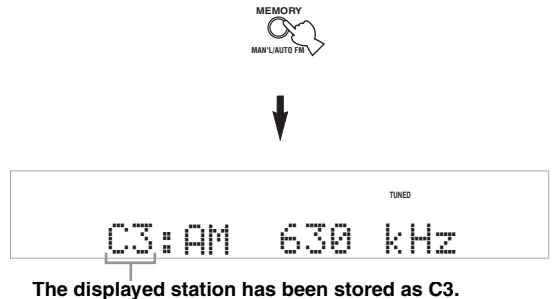

### 6 Repeat steps 1 through 5 to store other stations.

#### Notes

- Any stored station data existing under a preset station number is cleared when you store a new station under the same preset station number.
- The reception mode (stereo or monaural) is stored along with the station frequency.

## Selecting preset stations

You can tune into any desired station simply by selecting the preset station group and number under which it was stored.

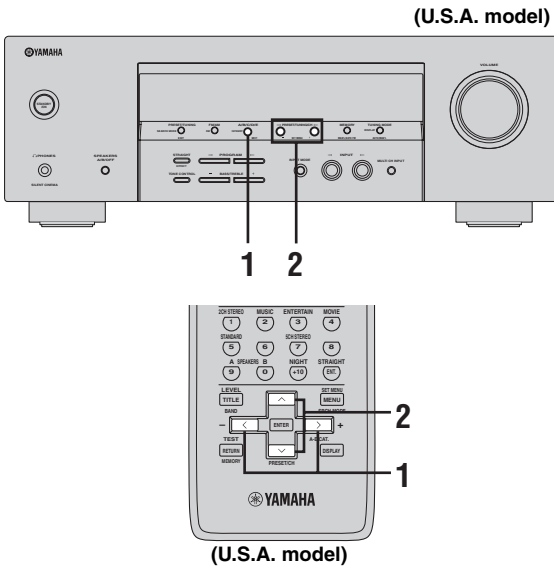

- Press **PRESET/TUNING/CH**  $\triangleleft/\triangleright$  on the front panel (or **PRESET/CH**  $\wedge/\vee$  on the remote control) to select the desired preset station number (1 to 8).

The preset station group and number appear in the front panel display along with the station band and frequency.

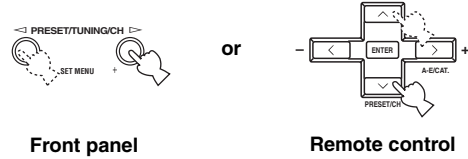

You can select the desired preset station number (1 to 8) directly by pressing the numeric buttons on the remote control.



When performing this operation with the remote control, press **TUNER** to select "FM" or "AM" as the input source.

- Press **A/B/C/D/E** on the front panel (or **A-E/CAT**  $\triangleleft/\triangleright$  on the remote control) repeatedly to select the desired preset station group (A to E).

The preset station group letter appears in the front panel display and changes each time you press the button.

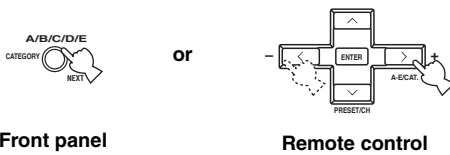

## Exchanging preset stations

You can exchange the assignments of two preset stations with each other. The example below describes the procedure to exchange preset station “E1” with “A5”.

(U.S.A. model)

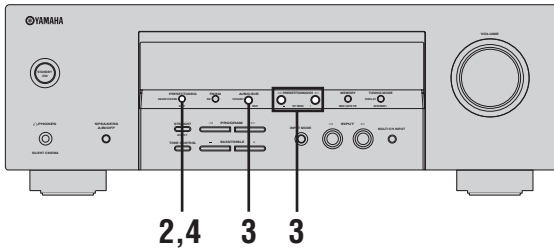

- 1 Select preset station “E1” using A/B/C/D/E and PRESET/TUNING/CH < / >.

See “Selecting preset stations” on page 39.

- 2 Press and hold PRESET/TUNING for more than 3 seconds.

“E1” and the MEMORY indicator flash in the front panel display.

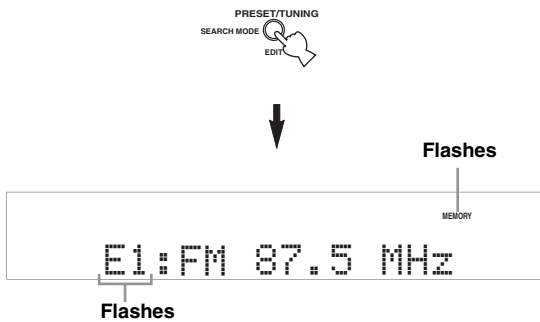

- 3 Select preset station “A5” using A/B/C/D/E and PRESET/TUNING/CH < / >.

“A5” and the MEMORY indicator flash in the front panel display.

See “Selecting preset stations” on page 39.

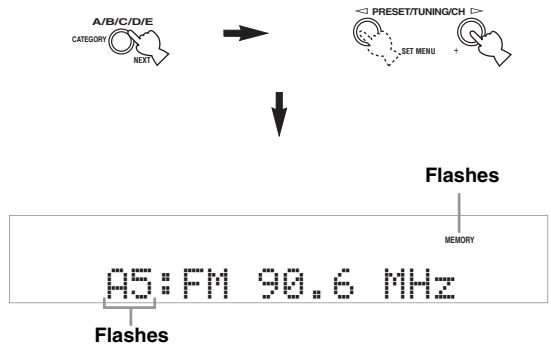

- 4 Press PRESET/TUNING again.

“EDIT E1–A5” appears in the front panel display and the assignments of the two preset stations are exchanged.



# XM® SATELLITE RADIO TUNING

## What is XM Satellite Radio?

XM Satellite Radio is the satellite radio service with millions of listeners across the United States, broadcasting live daily. The XM Satellite Radio channel lineup includes more than 150 digital channels of choice from coast to coast: 67 commercial-free music channels, featuring hip hop to opera, classical to country, bluegrass to blues; 33 channels of premier sports, talk, comedy, children's and entertainment programming; and more than 20 channels of the traffic and weather information for major metropolitan areas nationwide.

Because XM Satellite Radio is a subscription service, you will need to set up an account and activate service with XM using your XM Satellite Radio ID number. To check your ID number, follow "Activating XM Satellite Radio" on page 43. For further information on XM Satellite Radio services, visit the XM Satellite Radio website at "<http://www.xmradio.com/>".

### Notes

- The XM Satellite Radio service is only available in the 48 contiguous United States (not available in Alaska and Hawaii).
- XM Connect-and-Play digital antenna and monthly subscription are sold separately. For details, visit the XM Satellite Radio website at "<http://www.xmradio.com/>".

### ■ Information from XM Satellite Radio Inc.

Hardware and required basic monthly subscription sold separately. Premium Channel available at additional monthly cost. Installation costs and other fees and taxes, including a one-time activation fee may apply. Subscription fee is consumer only. All fees and programming subject to change. Channels with frequent explicit language are indicated with an "XL". Channel blocking is available for XM radio receivers by calling "1-800-XM-RADIO (1-800-967-2346)". Subscriptions subject to Customer Agreement available at [xmradio.com](http://xmradio.com). Only available in the 48 continuous United States. © 2005 XM Satellite Radio Inc. All rights reserved. All other trademarks are the property of their respective owners.

## Connecting the XM Connect-and-Play digital antenna

Connect the XM Connect-and-Play digital antenna accessory (sold separately) to the XM jack on the rear panel of this unit. For details, see the operating instructions provided with the XM Connect-and-Play digital antenna.

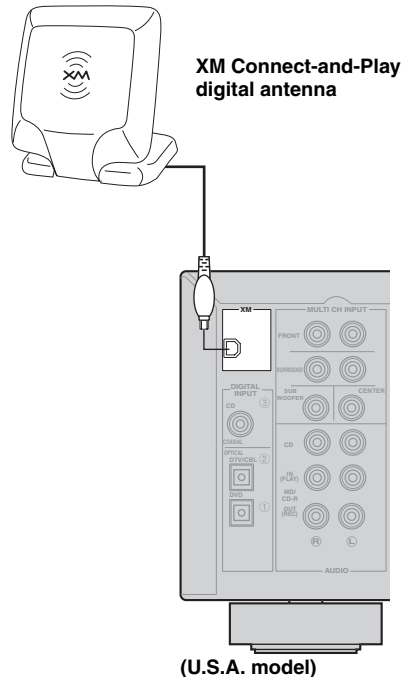

### Notes

- For information on obtaining the XM Connect-and-Play digital antenna, visit the XM Satellite Radio website at "<http://www.xmradio.com/>" or consult your local retailer that sells XM Ready products.
- To ensure the optimal reception of the XM Satellite Radio signals, the XM Connect-and-Play digital antenna must be placed at or near a southerly facing window with no obstacles in the path to the sky. You can mount it indoors or outdoors.

## XM Satellite Radio controls and functions

### Note

The following controls are available only when “XM” is selected as the input source. Press INPUT  $\triangleleft/\triangleright$  on the front panel repeatedly so that “TUNER” is displayed in the front panel display and then press XM on the front panel repeatedly (or press TUNER on the remote control and then press BAND repeatedly) to select “XM” as the input source.

### ■ Front panel functions

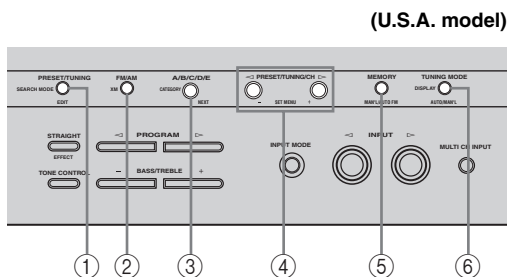

#### ① SEARCH MODE (PRESET/TUNING)

Changes the search mode between the All Channel Search, Category Search, and Preset Search modes (see page 45).

#### ② XM (FM/AM)

Switches the reception band to XM.

#### ③ CATEGORY (A/B/C/D/E)

##### (All Channel Search mode)

Changes the channel category while staying in the All Channel Search mode.

##### (Category Search mode)

Changes the channel category.

##### (Preset Search mode)

Changes the preset channel group (A to E).

#### ④ PRESET/TUNING/CH $\triangleleft/\triangleright$

##### (All Channel Search mode)

Searches for a channel within all channels. Press and hold for quick search.

##### (Category Search mode)

Searches for a channel within the selected category. Press and hold for quick search.

##### (Preset Search mode)

Changes the preset channel number (1 to 8).

#### ⑤ MEMORY

Stores a preset channel in the memory (see page 49).

#### ⑥ DISPLAY (TUNING MODE)

Switches the XM information such as channel number/name, category, artist name/song title in the front panel display (see page 50).

### ■ Remote control functions

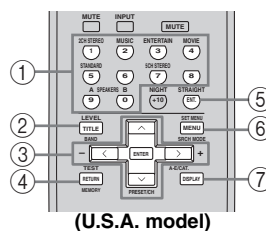

#### ① Numeric buttons

##### (All Channel Search or Category Search mode)

Use 1 to 9 and 0 to enter a channel number directly.

##### (Preset Search mode)

Use 1 to 8 to enter a preset channel number directly.

#### ② BAND

Switches the reception band to XM.

#### ③ A-E/CAT. $\triangleleft/\triangleright$ , PRESET/CH $\wedge/\vee$

##### (All Channel Search mode)

Press A-E/CAT.  $\triangleleft/\triangleright$  to change the channel category.

Press PRESET/CH  $\wedge/\vee$  to search for a channel within all channels. Press and hold for quick search.

##### (Category Search mode)

Press A-E/CAT.  $\triangleleft/\triangleright$  to change the channel category.

Press PRESET/CH  $\wedge/\vee$  to search for a channel within the selected category. Press and hold for quick search.

##### (Preset Search mode)

Press A-E/CAT.  $\triangleleft/\triangleright$  to change the preset channel group (A to E).

Press PRESET/CH  $\wedge/\vee$  to change the preset channel number (1 to 8).

#### ④ MEMORY

Stores a preset channel in the memory (see page 49).

#### ⑤ ENT.

Confirms an entered channel number in the Direct Number Access mode (see page 48).

#### ⑥ SRCH MODE

Changes the search mode between the All Channel Search, Category Search, and Preset Search modes (see page 45).

#### ⑦ DISPLAY

Switches the XM information such as channel number/name, category, artist name/song title in the front panel display (see page 50).

## Activating XM Satellite Radio

To sign up for an account with the XM Satellite Radio service, an XM Satellite Radio ID number is required. Follow the procedure below to check your ID number, and then visit the website at “<http://activate.xmradio.com/>” or call “1-800-XM-RADIO (1-800-967-2346)” with a major credit card handy for signing up.

(U.S.A. model)

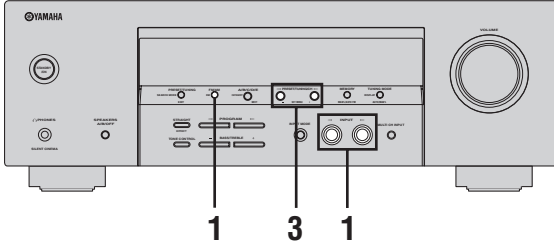

**1** Press INPUT  $\triangleleft/\triangleright$  on the front panel repeatedly so that “TUNER” is displayed in the front panel display and then press XM on the front panel repeatedly to select “XM” as the input source.



**2** Check the XM Satellite Radio reception level and adjust the orientation of the XM Connect-and-Play digital antenna for a better percentage of the reception level.



You can display the XM Satellite Radio reception level by using “XM ANT.” in “OPTION MENU” (see page 56).

### Notes

- If “CHECK ANTENNA” appears in the front panel display, the XM Connect-and-Play digital antenna may not be connected to the XM jack on the rear panel of this unit properly. See “Connecting the XM Connect-and-Play digital antenna” on page 41 and check the connection.
- “XM ANT.” in “OPTION MENU” (see page 56) cannot be adjusted by using the remote control. Instead, you need to adjust the orientation of the XM Connect-and-Play digital antenna connected to the XM jack of this unit for a better percentage of the reception level.

**3** Press PRESET/TUNING/CH  $\triangleleft/\triangleright$  on the front panel to select channel “0”.



### Note

You cannot select channel “0” if the All Channel Search mode (see page 45) is not selected.

**4** Check the XM Satellite Radio ID number displayed in the front panel display and write it down.

ID: \_\_\_\_\_

## Basic XM Satellite Radio operations

(U.S.A. model)

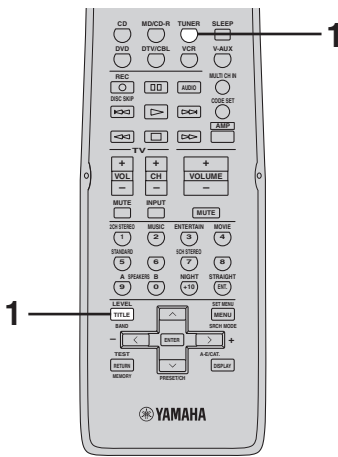
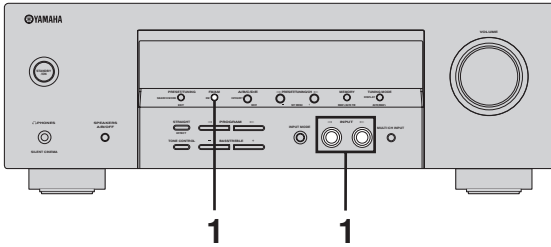

(U.S.A. model)

- 1 Press **INPUT**  $\triangleleft/\triangleright$  on the front panel repeatedly so that “TUNER” is displayed in the front panel display and then press **XM** on the front panel repeatedly (or press **TUNER** on the remote control and then press **BAND** repeatedly) to select “XM” as the input source.

The XM indicator lights up in the front panel display and the XM Satellite Radio information (such as channel number/name, category, artist name/song title) for the currently selected channel appears in the front panel display.

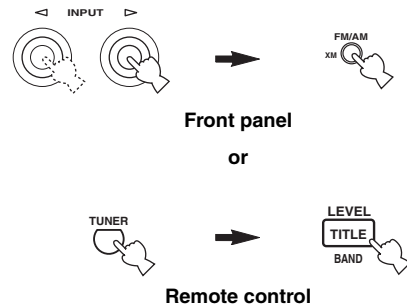

- When you select “XM” as the input source, this unit automatically recalls the previously selected channel.
- You can change the kind of channel information by pressing **DISPLAY** on the remote control repeatedly (see page 50).

### Note

The XM Satellite Radio signals cannot be output at the **AUDIO OUT (REC)** jacks.

- 2 Search for a channel by using one of the **XM Satellite Radio search modes**. See “Selecting the XM Satellite Radio search mode” on page 45 for details.
- 3 Set **XM Satellite Radio preset channels, if desired**. See “Setting XM Satellite Radio preset channels” on page 49 for details.
- 4 Display the **XM Satellite Radio information in the front panel display**. See “Displaying the XM Satellite Radio information” on page 50 for details.



## Selecting the XM Satellite Radio search mode

You can search for the desired channel using one of the three search modes (All Channel Search, Category Search, and Preset Search modes). You can also enter the channel number directly to select the desired channel by using the Direct Number Access mode (see page 48).

### All Channel Search mode

(U.S.A. model)

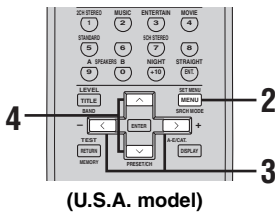
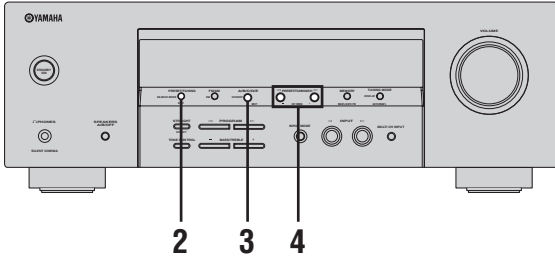

(U.S.A. model)

- 1 Select "XM" as the input source.  
See "Basic XM Satellite Radio operations" on page 44 for details.
- 2 Press SEARCH MODE on the front panel (or SRCH MODE on the remote control) repeatedly to select "ALL CH SEARCH".

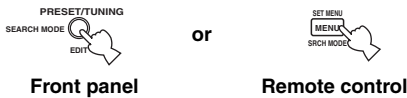

Front panel

Remote control

- 3 Press CATEGORY on the front panel (or A-E/CAT. </> on the remote control) repeatedly to change the channel category.



Front panel

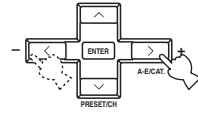

Remote control

- 4 Press PRESET/TUNING/CH </> on the front panel (or PRESET/CH ^ / v on the remote control) repeatedly to search for a channel within all channels.



Front panel

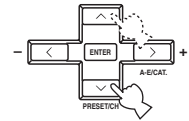

Remote control



You can search for a channel quickly by pressing and holding PRESET/TUNING/CH </> on the front panel (or PRESET/CH ^ / v on the remote control).

**■ Category Search mode**

(U.S.A. model)

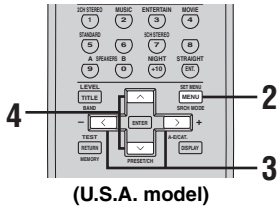
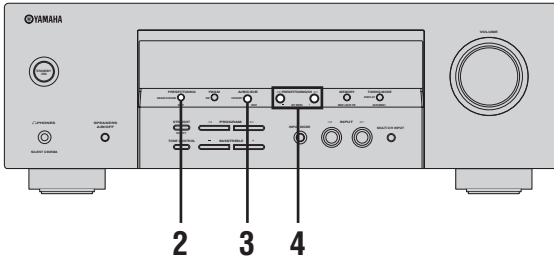

**1 Select “XM” as the input source.**  
See “Basic XM Satellite Radio operations” on page 44 for details.

**2 Press SEARCH MODE on the front panel (or SRCH MODE on the remote control) repeatedly to select “CAT SEARCH”.**

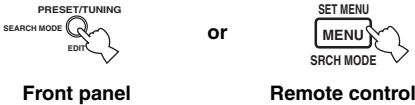

**3 Press CATEGORY on the front panel (or A-E/CAT. </> on the remote control) repeatedly to change the channel category.**

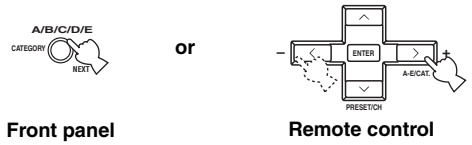

**4 Press PRESET/TUNING/CH </> on the front panel (or PRESET/CH ^ / v on the remote control) repeatedly to search for a channel within the selected channel category.**

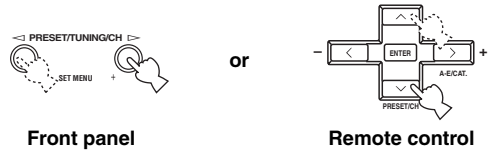

You can search for a channel quickly by pressing and holding PRESET/TUNING/CH </> on the front panel (or PRESET/CH ^ / v on the remote control).

## ■ Preset Search mode

Prior to selecting a preset channel in the Preset Search mode, you must preset XM Satellite Radio channels. For details, see “Setting XM Satellite Radio preset channels” on page 49.



All preset channels (A1 to E8) recalls “001 Preview” by the initial factory setting.

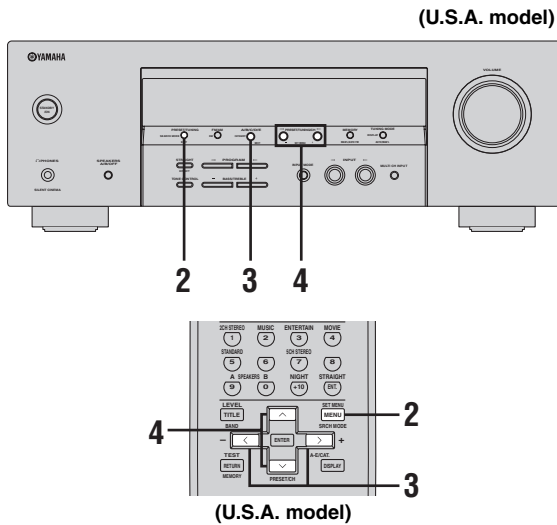

### 1 Select “XM” as the input source.

See “Basic XM Satellite Radio operations” on page 44 for details.

### 2 Press SEARCH MODE on the front panel (or SRCH MODE on the remote control) repeatedly to select “PRESET SEARCH”.

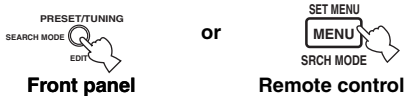

### 3 Press CATEGORY on the front panel (or A-E/CAT. </> on the remote control) repeatedly to change the preset channel group (A to E).

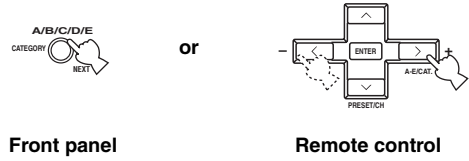

### 4 Press PRESET/TUNING/CH </> on the front panel (or PRESET/CH ^ / v on the remote control) repeatedly to change the preset channel number (1 to 8).

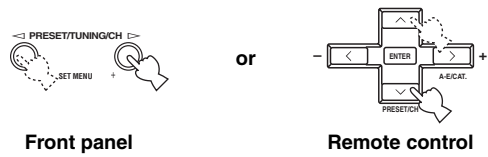

You can also select the preset channel number directly by pressing the numeric buttons (1 to 8) on the remote control.

**Direct Number Access mode**

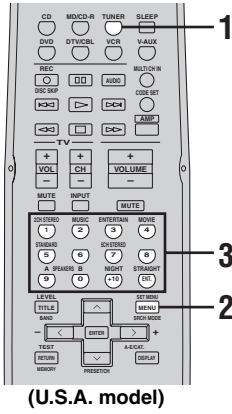

- 1** Select “XM” as the input source.  
See “Basic XM Satellite Radio operations” on page 44 for details.
- 2** Press SRCH MODE on the remote control repeatedly to select “ALL CH SEARCH” or “CAT SEARCH”.



- 3** Press the numeric buttons on the remote control to enter the desired three-digit channel number.

For example, to enter the number 123, press the numeric buttons as shown below.



The display changes as follows.

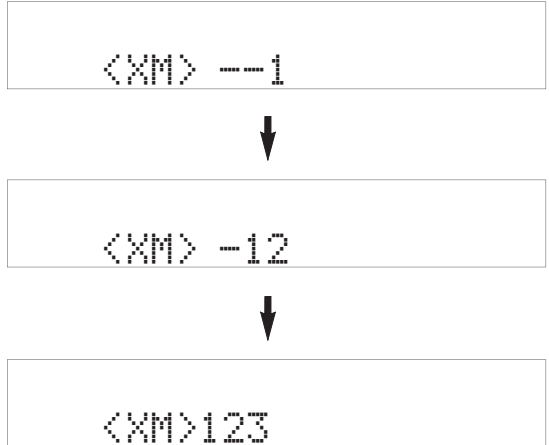

**Press the numeric buttons and ENT. on the remote control to enter the desired one-digit or two-digit channel number.**

For example, to enter the number 12, press the numeric buttons as shown below.



- If no button is pressed within a few seconds after you enter a one-digit or two-digit number, this unit automatically confirms the entered channel number.
- Pressing a button other than the numeric buttons or ENT. cancels the Direct Number Access mode procedure.

## Setting XM Satellite Radio preset channels

You can use this feature to store up to 40 XM Satellite Radio channels (A1 to E8: 8 preset channel numbers in each of the 5 preset channel groups). You can then recall any preset channel easily by selecting the preset channel group and number as described in “Preset Search mode” on page 47.

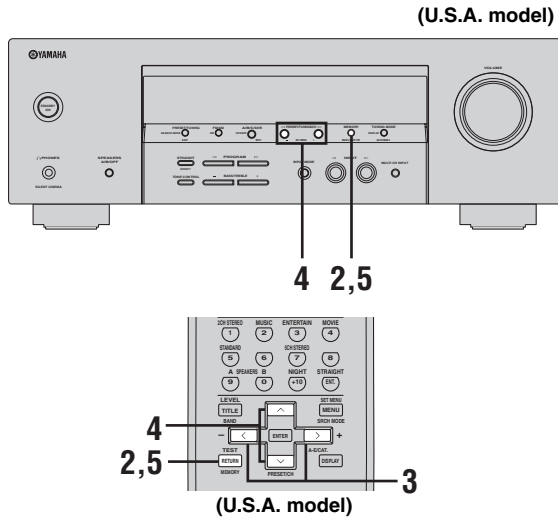

- 1 Search for a channel you want to set as a preset channel by using one of the XM Satellite Radio search modes.**  
See “Selecting the XM Satellite Radio search mode” on page 45 for details.



- 2 Press MEMORY on the front panel (or MEMORY on the remote control).**  
The MEMORY indicator flashes in the front panel display for approximately 5 seconds.

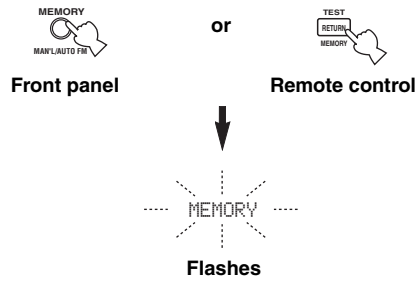

**Note**

You must proceed to and carry out steps 3 through 5 while the MEMORY indicator is flashing in the front panel display.

- 3 Press CATEGORY on the front panel (or A-E/CAT. </> on the remote control) repeatedly to select a preset channel group (A to E) while the MEMORY indicator is flashing.**

The preset channel group letter appears in the front panel display.

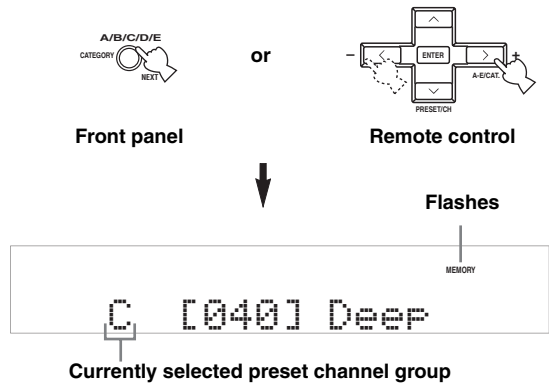

- 4 Press PRESET/TUNING/CH ◀/▶ on the front panel (or PRESET/CH ^/▼ on the remote control) repeatedly to select a preset channel number (1 to 8) while the MEMORY indicator is flashing.**

The preset channel number appears in the front panel display.

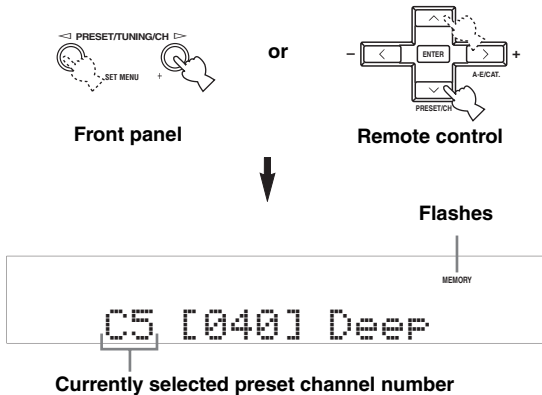

- 5 Press MEMORY on the front panel (or MEMORY on the remote control) to set the selected XM Satellite Radio channel as a preset channel while the MEMORY indicator is flashing.**

A colon (:) appears next to the preset channel number for confirmation, and the MEMORY indicator turns off in the front panel display.

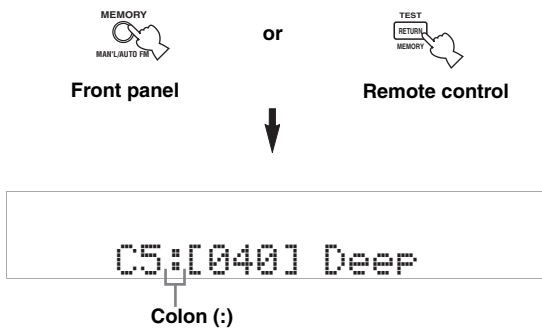

**Note**

Once you set a new preset channel, the one previously stored in the same preset channel group and number is cleared.

## Displaying the XM Satellite Radio information

You can display the XM Satellite Radio information (such as channel number/name, category, artist name/song title) for the currently selected channel in the front panel display.

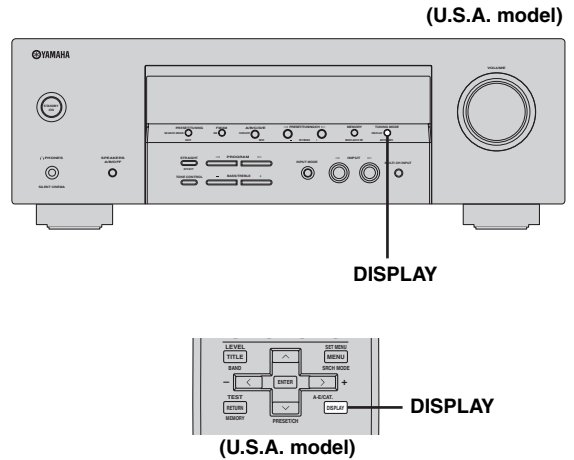

**Note**

If a status message or an error message appears in the front panel display, see the “XM Satellite Radio (U.S.A. model only)” section in “TROUBLESHOOTING” on page 63 for appropriate remedies.

### ■ Displaying the XM Satellite Radio information in the front panel display

Press DISPLAY on the front panel or on the remote control repeatedly to toggle between the following XM Satellite Radio information display modes.

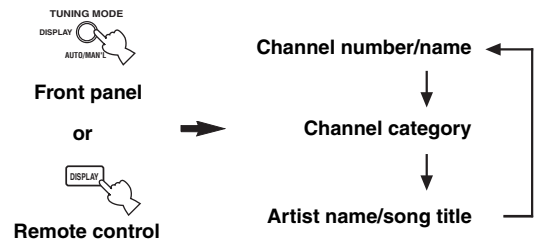

When the channel number/name is displayed:



[040] Deep Tra

When the channel category is displayed:



<CAT>Rock

When the artist name/song title is displayed:



Coldplay / Clo



- The front panel display can indicate up to 14 alphanumeric characters at once. You can set whether to display the XM Satellite Radio information in the front panel display in a continuous manner or by 14 alphanumeric characters at once by using the “SCROLL” parameter in “OPTION MENU” (see page 56).
- If the XM Satellite Radio information contains a character that cannot be recognized by this unit, the character will be replaced with a space.

#### Note

If you press DISPLAY while the XM Satellite Radio information display is scrolling from right to left in the front panel display, the XM Satellite Radio information display mode toggles as described above.

# SET MENU

You can use the following parameters in “SET MENU” to adjust a variety of system settings and customize the way this unit operates. Change the initial settings (indicated in bold under each parameter) to reflect the needs of your listening environment.

## ■ BASIC MENU

Use this feature to set up your system quickly and with minimal effort (see page 20).

## ■ SOUND MENU

Use this menu to manually adjust any speaker settings, alter the quality and tone of the sound output by the system.

Parameter	Features	Page
1 SPEAKER SET	Selects the size of each speaker, the speakers for low-frequency signal output, and the crossover frequency.	53
2 SP DISTANCE	Adjusts the delay time of each speaker.	54
3 LFE LEVEL	Adjusts the output level of the LFE channel for Dolby Digital or DTS signals.	54
4 D. RANGE	Adjusts the dynamic range of Dolby Digital or DTS signals.	55
5 TC. BYPASS	Adjusts the tone bypass settings.	55

## ■ INPUT MENU

Use this menu to manually reassign the input jacks, select the input mode or rename the input source.

Parameter	Features	Page
1 INPUT ASSIGN	Assigns the input jacks of this unit according to the component to be used.	55
2 INPUT MODE	Selects the initial input mode of the source.	55

## ■ OPTION MENU

Use this menu to manually adjust the optional system parameters.

Parameter	Features	Page
1 DISPLAY SET	Adjusts the brightness of the display.	56
2 MEM. GUARD	Locks sound field program parameters and other “SET MENU” settings.	56
3 AUDIO MUTE	Adjusts the muting level.	56
4 XM RADIO SET	Displays the current reception level of the XM Connect-and-Play digital antenna.	56

### Note

The “XM RADIO SET” parameter is only applicable to the U.S.A. model.



## Using SET MENU

Use the remote control to access and adjust each parameter.

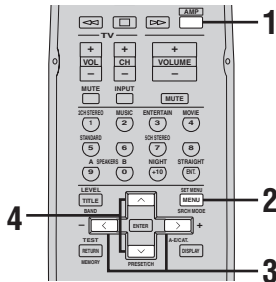

- You can change the “SET MENU” parameters while this unit is reproducing sound.
- You can use NEXT (A/B/C/D/E) and SET MENU +/- (PRESET/TUNING/CH </>) on the front panel to change these settings, if “TUNER” is not selected as the input source. Press NEXT to select the category or field you wish to change, and SET MENU +/- to change the parameters.

### 1 Press AMP.

### 2 Press SET MENU repeatedly to display the desired menu and then press > to enter the menu.



Once you press SET MENU, you can also select the menu by pressing ^ / ∨.

### 3 Press ^ / ∨ repeatedly to select the item and then press </> to change the parameter.

Depending on the menu item, press ^ / ∨ to select a sub item, and then press </> to change the parameter.

### 4 To exit, press ^ / ∨ repeatedly until the menu disappears.

## SOUND MENU

Use this menu to manually adjust any speaker settings.

### Notes

- If you select “SETUP” (see page 20) and then select “SET” after adjusting the “SOUND MENU” parameters, the “SETUP” parameters override the “SOUND MENU” parameters. Do not enter “SETUP” unless you wish to change the “SOUND MENU” parameters. If you accidentally enter “SETUP”, select “CANCEL” to exit from “SETUP”.
- Some menu item settings have no effect when the unit is reproducing a source with a digital signal sampling frequency greater than 48 kHz.

### ■ Speaker settings 1 SPEAKER SET

Use this feature to manually adjust any speaker setting.



If you are not satisfied with the bass sounds from your speakers, you can change these settings according to your preference.

#### Center speaker 1A CENTER

Choices: LRG (large), SML (small), NON (none)

- Select “LRG” if you have a large center speaker. The entire range of the center channel signals is directed to the center speaker.
- Select “SML” if you have a small center speaker. The low-frequency signals of the center channel are directed to the speakers selected with “1D BASS”.
- Select “NON” if you do not have a center speaker. The entire range of the center channel signals is directed to the front left and right speakers.

#### Front speakers 1B FRONT

Choices: LRG (large), SML (small)

- Select “SML” if you have small front speakers. The low-frequency signals of the front channel are directed to the speakers selected with “1D BASS”.
- Select “LRG” if you have large front speakers. The entire range of the front left and right channel signals is directed to the front left and right speakers.

**Surround left/right speakers 1C SURR**

Choices: LRG (large), **SML** (small), NON (none)

- Select “LRG” if you have large surround left and right speakers. The entire range of the surround channel signals is directed to the surround left and right speakers.
- Select “SML” if you have small surround left and right speakers. The low-frequency signals of the surround channel are directed to the speakers selected with “1D BASS”.
- Select “NON” if you do not have surround speakers. This will set this unit to the Virtual CINEMA DSP mode (see page 33).

**Bass out 1D BASS**

Use this feature to select the speakers that output the LFE (low-frequency effect) and the low-frequency signals.

Choices: SWFR (subwoofer), FRNT (front), **BOTH**

- Select “SWFR” if you connected a subwoofer. The LFE signals as well as the low-frequency signals of other speakers set to “SML” or to “NON” are directed to the subwoofer.
- Select “FRNT” if you did not connect a subwoofer. The LFE signals, the low-frequency signals of the front left and right channels, and the low-frequency signals of other speakers set to “SML” or to “NON” are all directed to the front left and right speakers regardless of the “1B FRONT” setting.
- Select “BOTH” if you connected a subwoofer. The low-frequency signals of any source are output from the subwoofer. The LFE signals as well as the low-frequency signals of other speakers set to “SML” or to “NON” are directed to the subwoofer. The low-frequency signals of the front left and right channels are directed to the front left and right speakers and the subwoofer regardless of the “1B FRONT” setting.

**Speaker distance 2 SP DISTANCE**

Use this feature to manually adjust the distance of each speaker and the delay applied to the respective channel. Ideally, each speaker should be the same distance from the main listening position. However, this is not possible in most home situations. Thus, a certain amount of delay must be applied to the sound from each speaker so that all sounds will arrive at the listening position at the same time.

**Unit UNIT**

Choices: meters, feet

Initial setting:

[U.S.A. and Canada models]: feet

[Other models]: meters

- Select “meters” to adjust speaker distances in meters.
- Select “feet” to adjust speaker distances in feet.

**Speaker distances**

Control range: 0.30 to 24.00 m (1.0 to 80.0 ft)

Control step: 0.10 m (0.5 ft)

Initial settings: 3.00 m (10.0 ft)

- Select “FRONT” to adjust the distance of the front speaker.
- Select “CENTER” to adjust the distance of the center speaker.
- Select “SURR” to adjust the distance of the surround speaker.

**Notes**

- “CENTER” and “SURR” cannot be adjusted if “1A CENTER” and “1C SURR” are set to “NON” respectively.
- No delay will be set if you set the same distance for “FRONT”, “CENTER”, and “SURR”.

**Low-frequency effect level 3 LFE LEVEL**

Use this feature to adjust the output level of the LFE (low-frequency effect) channel according to the capacity of your subwoofer or headphones. The LFE channel carries low-frequency special effects which are only added to certain scenes. This setting is effective only when this unit decodes Dolby Digital or DTS signals.

Control range: -20 to 0 dB

Control step: 1 dB

**Speaker SP LFE**

Adjusts the speaker LFE level.

**Headphone HP LFE**

Adjusts the headphone LFE level.

**Notes**

- Adjust the LFE level according to the capacity of your subwoofer or headphones.
- Depending on the settings of “1D BASS”, some signals may not be output at the SUBWOOFER OUTPUT jack.

## ■ Dynamic range 4 D.RANGE

Use this feature to select the amount of dynamic range compression to be applied to your speakers or headphones. This setting is effective only when the unit is decoding Dolby Digital and DTS signals.

Choices: MIN (minimum), STD (standard), **MAX** (maximum)

### Speaker SP D.R

Adjusts the speaker compression.

### Headphone HP D.R

Adjusts the headphone compression.

- Select “MIN” if you regularly listen at low volume levels.
- Select “STD” for general use.
- Select “MAX” to preserve the greatest amount of dynamic range.

## ■ Tone bypass 5 TC.BYPASS

Use this feature to select whether audio output bypasses tone control circuitry when “BASS” and “TREBLE” are set to 0 dB (see page 24).

Choices: **AUTO**, OFF

- Select “AUTO” if you want signals to bypass tone control circuitry to provide the purest signal possible.
- Select “OFF” if you do not want signals to bypass tone control circuitry.

## INPUT MENU

Use this menu to reassign input jacks or select the input mode.

### ■ Input assignment 1 INPUT ASSIGN

Use this feature to assign the input jacks according to the component to be used if the initial settings of this unit do not correspond to your needs. Change the following parameters to reassign the respective jacks and effectively connect more components.

Once the input jacks are reassigned, you can select the corresponding component by using INPUT ◀/▶ on the front panel (or the input selector buttons on the remote control).

#### For COMPONENT VIDEO jacks [A][B][C]

Choices: [A] **DVD**, DTV/CBL, VCR, V-AUX  
 [B] DVD, **DTV/CBL**, VCR, V-AUX  
 [C] DVD, DTV/CBL, **VCR**, V-AUX

#### For OPTICAL INPUT jacks 1 2

Choices: (1) **DVD**, DTV/CBL, CD, VCR, MD/CD-R, V-AUX  
 (2) DVD, **DTV/CBL**, CD, VCR, MD/CD-R, V-AUX

#### For COAXIAL INPUT jack 3

Choices: (3) **DVD**, DTV/CBL, CD, VCR, MD/CD-R, V-AUX

### Note

- You cannot select a specific item more than once for the same type of jack.
- When you connect a component to both the COAXIAL and OPTICAL jacks, priority is given to the signals input at the COAXIAL jack.

### ■ Input mode 2 INPUT MODE

Use this feature to designate the input mode for sources connected to the DIGITAL INPUT jacks when you turn on this unit (see page 26).

Choices: **AUTO**, LAST

- Select “AUTO” to allow this unit to automatically detect the type of input signal and select the appropriate input mode.
- Select “LAST” to set this unit to automatically select the last input mode used for that source.

## OPTION MENU

Use this menu to adjust the optional system parameters.

### ■ Display settings 1 DISPLAY SET

#### Dimmer DIMMER

Use this feature to adjust the brightness of the front panel display.

Choices: -4 to 0

Control step: 1

- Press < to make the front panel display dimmer.
- Press > to make the front panel display brighter.

### ■ Memory guard 2 MEM. GUARD

Use this feature to prevent accidental changes to sound field program parameter values and other system settings.

Choices: ON, OFF

- Select "OFF" to turn off the "MEM. GUARD" feature.
- Select "ON" to protect:
  - Sound field program parameters
  - All "MENU" items
  - All speaker levels

#### Note

When "MEM. GUARD" is set to "ON", you cannot select and adjust any other "SET MENU" items.

### ■ Audio mute 3 AUDIO MUTE

Use this feature to adjust how much the mute function reduces the output volume.

Choices: MUTE, -50 dB, -20 dB

- Select "MUTE" to completely mute all the audio output.
- Select "-50 dB" to reduce the current volume by 50 dB.
- Select "-20 dB" to reduce the current volume by 20 dB.

### ■ XM Radio setting 4 XM RADIO SET

#### XM Radio antenna XM ANT.

Use this feature to check the current reception level of the XM Connect-and-Play digital antenna connected to the XM jack of this unit (see page 41). For the best reception, orient the XM Connect-and-Play digital antenna so that a value of 60% or more is displayed here.

Display status: NONE, 0 to 100%

#### Notes

- "NONE" is displayed if the XM Connect-and-Play digital antenna is not connected to this unit. In this case, check the antenna connections (see page 41).
- The "XM ANTENNA" parameter cannot be adjusted by using the remote control. Instead, you need to adjust the orientation of the XM Connect-and-Play digital antenna connected to the XM jack of this unit for a better percentage of the reception level.

#### XM Radio information display scroll SCROLL

Use this feature to set whether to scroll the XM Satellite Radio information display in a continuous manner or by 14 alphanumeric characters at once (see page 50).

Choices: CONT, ONCE

- Select "CONT" to scroll the XM Satellite Radio information display in a continuous manner.
- Select "ONCE" to scroll the XM Satellite Radio information display by 14 alphanumeric characters at once.

# REMOTE CONTROL FEATURES

In addition to controlling this unit, the remote control can also operate other audiovisual components made by YAMAHA and other manufacturers. To control other components, you must set up remote control with the appropriate remote control codes (see page 59).

## Controlling this unit, a TV, or other components

### ■ Controlling this unit

Press AMP to control this unit.

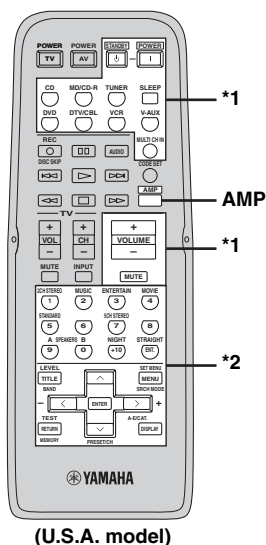

### ■ Controlling a TV

Press DTV/CBL to control your TV.

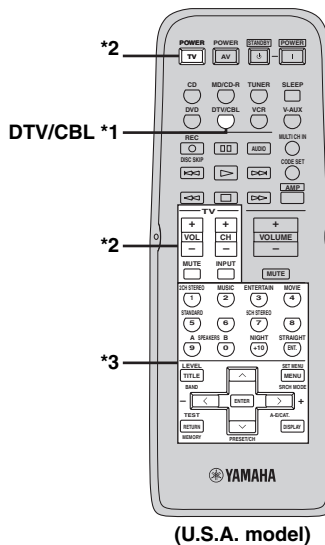

### Notes

- \*1 These buttons always control this unit.
- \*2 These buttons control this unit only when AMP is pressed.

### Notes

- \*1 To control your TV, you must set the appropriate remote control code for DTV/CBL.
- \*2 These buttons always control your TV regardless of whether you press DTV/CBL or not.

Remote control	Digital TV/Cable TV
TV POWER	Turns on or off the power.
TV VOL +/-	Increases or decreases the volume level.
TV CH +/-	Changes the channel number.
TV MUTE	Mutes the audio output.
TV INPUT	Changes the input source.

- \*3 These buttons control your TV only when DTV/CBL is pressed. For details, see the "Digital TV/Cable TV" column on page 58.

### ■ Controlling other components

Once you set the appropriate remote control codes (see page 59), use the input selector buttons to select the component you want to control. Note that some buttons may not correctly operate the selected component.

#### Notes

- \*1 This button functions only when the original remote control of the component has a POWER button.
- \*2 These buttons can operate your VCR when the remote control code of your VCR is set in VCR and DTV/CBL is selected.
- \*3 When you use this button to record a source, press it twice repeatedly to prevent a malfunction.

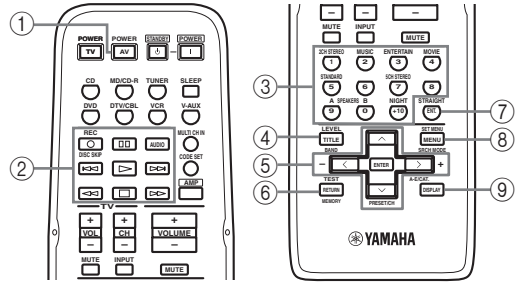

Remote control	DVD player	VCR	Digital TV/ Cable TV	CD player	MD/CD recorder	Tuner (FM/AM)	Tuner (XM)
① AV POWER	Power *1	Power *1	Power *2	Power *1	Power *1		
② REC/ DISC SKIP	Disc skip	Rec *3	Rec *2,3	Disc Skip	Rec (MD)		
▷	Play	Play	Play *2	Play	Play		
◀◀	Search backward	Search backward	Search backward *2	Search backward	Search backward		
▶▶	Search forward	Search forward	Search forward *2	Search forward	Search forward		
AUDIO	Audio						
⏸	Pause	Pause	Pause *2	Pause	Pause		
◀◀◀	Skip backward			Skip backward	Skip backward		
▶▶▶	Skip forward			Skip forward	Skip forward		
□	Stop	Stop	Stop *2	Stop	Stop		
③ 0-9, +10	Numeric buttons	Numeric buttons	Numeric buttons	Numeric buttons	Numeric buttons	Preset stations (1-8)	Preset channels (1-8)/ direct number access
④ TITLE	Title					Band	Band
⑤ PRESET/CH ^	Up	VCR channel up				Preset up (1-8)	Preset/channel up
PRESET/CH v	Down	VCR channel down				Preset down (1-8)	Preset/channel down
A-E/CAT. <	Left					Preset down (A-E)	Category/group down
A-E/CAT. >	Right					Preset up (A-E)	Category/group up
ENTER	Select						
⑥ RETURN	Return						Memory
⑦ ENT.	Title/Index	Enter	Enter	Index	Index		Enter
⑧ MENU	Menu						Search mode
⑨ DISPLAY	Display		Display	Display	Display		Display

## Setting remote control codes

You can control other components by setting the appropriate remote control codes. You can set the remote control codes for each input source. For a complete list of available remote control codes, refer to “LIST OF REMOTE CONTROL CODES” at the end of this manual.

The following table shows the default component (Library: component category) and the remote control code for each input source.

### Remote Control Code Default Settings

Input source	Library (component category)	Manufacturer	Default code
CD	CD	YAMAHA	199
MD/CD-R	CD-R	YAMAHA	499
TUNER *1	TUNER	YAMAHA	Fixed
DVD	DVD	YAMAHA	699
DTV/CBL*2	-	-	-
VCR	-	-	-
V-AUX	-	-	-

\*1 You can control this unit only.

\*2 You can only set TV remote control codes in DTV/CBL.

#### Note

You may not be able to operate your YAMAHA component even if a YAMAHA remote control code is initially set as listed above. In this case, try setting other YAMAHA remote control codes.

- 1 While holding down CODE SET, press one of the input selector buttons to select the component you want to set up.

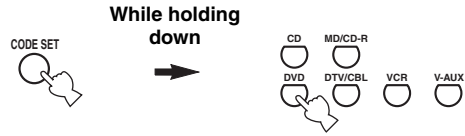

#### Note

You need to hold down CODE SET throughout this procedure.

- 2 While holding down CODE SET, press the numeric buttons (0 to 9) to enter the three-digit remote control code for the component to be used.

Refer to “LIST OF REMOTE CONTROL CODES” at the end of this manual.

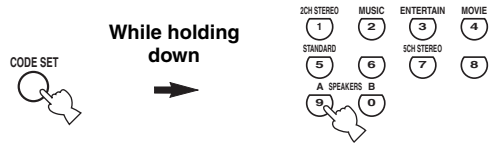

#### Notes

- If the manufacturer of your component has more than one code, try each of them until you find the correct one.
- You can only assign one remote control code to each input selector button.

# TROUBLESHOOTING

Refer to the table below when this unit does not function properly. If the problem you are experiencing is not listed below or if the instruction below does not help, turn off this unit, disconnect the power cable, and contact the nearest authorized YAMAHA dealer or service center.

## ■ General

Problem	Cause	Remedy	See page
<b>This unit fails to turn on or enters the standby mode soon after the power is turned on.</b>	The power cable is not connected or the plug is not completely inserted.	Connect the power cable firmly.	—
	The speaker impedance setting is incorrect.	Set the speaker impedance to match your speakers.	9, 11
	The protection circuitry has been activated.	Make sure that all speaker wire connections on this unit and on all speakers are secure and that the wire for each connection does not touch anything other than its respective connection.	11
	This unit has been exposed to a strong external electric shock (such as lightning or strong static electricity).	Set this unit to the standby mode, disconnect the power cable, plug it back in after 30 seconds and then use it normally.	—
<b>No sound</b>	Incorrect input or output cable connections.	Connect the cables properly. If the problem persists, the cables may be defective.	13-17
	No appropriate input mode has been selected.	Select an appropriate input mode.	26
	No appropriate input source has been selected.	Select an appropriate input source with INPUT ◀/▶ on the front panel (or the input selector buttons on the remote control) and MULTI CH INPUT on the front panel (or MULTI CH IN on the remote control).	23, 25
	Speaker connections are not secure.	Secure the connections.	11
	The front speakers to be used have not been selected properly.	Select the front speakers with SPEAKERS on the front panel or SPEAKERS A/B on the remote control.	23
	The volume is turned down.	Turn up the volume.	—
	The sound is muted.	Press MUTE or VOLUME +/- on the remote control to resume audio output and then adjust the volume.	25
	Signals this unit cannot reproduce are being input from a source component, such as a CD-ROM.	Play a source whose signals can be reproduced by this unit.	—



Problem	Cause	Remedy	See page
<b>The sound suddenly goes off.</b>	The protection circuitry has been activated because of a short circuit, etc.	Check that the impedance selector setting is correct.	9, 11
		Check that the speaker wires are not touching each other and then turn this unit back on.	—
	The sleep timer has turned off this unit.	Turn on this unit, and play the source again.	—
	The sound is muted.	Press MUTE or VOLUME +/- on the remote control to resume audio output.	25
<b>Sound is heard from the speaker on one side only.</b>	Incorrect cable connections.	Connect the cables properly. If the problem persists, the cables may be defective.	13-17
	Incorrect settings in "SP LEVEL".	Adjust the "SP LEVEL" settings.	26
<b>Only the center speaker outputs substantial sound.</b>	When playing a monaural source with a CINEMA DSP program, the source signal is directed to the center channel, and the front and surround speakers output effect sounds.		
<b>No sound is heard from the center speaker.</b>	"CENTER" in "SET MENU" is set to "NONE".	Set "CENTER" to "SML" or "LRG".	53
	One of the HiFi DSP programs (except for 5ch Stereo) has been selected.	Try another sound field program.	30
<b>No sound is heard from the surround speakers.</b>	"SURR" in "SPEAKER SET" is set to "NONE".	Set "SURR" to "SML" or "LRG".	54
	This unit is in the "STRAIGHT" mode and a monaural source is being played back.	Press STRAIGHT on the front panel so that "STRAIGHT" disappears from the front panel display.	33
<b>No sound is heard from the subwoofer.</b>	"BASS" in "SPEAKER SET" is set to "FRNT" when a Dolby Digital or DTS signal is being played.	Set "BASS" to "SWFR" or "BOTH".	54
	"BASS" in "SPEAKER SET" is set to "SWFR" or "FRNT" when a 2-channel source is being played.	Set "BASS" to "BOTH".	54
	The source does not contain low-frequency bass signals.		

Problem	Cause	Remedy	See page
<b>Dolby Digital or DTS sources cannot be played. (Dolby Digital or DTS indicator in the front panel display does not light up.)</b>	The connected component is not set to output Dolby Digital or DTS digital signals.	Make an appropriate setting following the operating instructions for your component.	—
	“INPUT MODE” is set to “ANALOG”.	Set “INPUT MODE” to “AUTO” or “DTS”.	26
<b>A humming sound is heard.</b>	Incorrect cable connections.	Connect the audio cables firmly. If the problem persists, the cables may be defective.	—
<b>The volume level cannot be increased, or the sound is distorted.</b>	The component connected to the AUDIO OUT (REC) jacks of this unit is turned off.	Turn on the power of the component.	—
<b>The sound effect cannot be recorded.</b>	It is not possible to record the sound effect with a recording component.		
<b>A source cannot be recorded by an analog component connected to the AUDIO OUT (REC) jacks.</b>	The source component is not connected to the analog AUDIO IN jacks of this unit.	Connect the source component to the analog AUDIO IN jacks.	14, 17
<b>The sound field parameters and some other settings of this unit cannot be changed.</b>	“MEM. GUARD” in “OPTION MENU” is set to “ON”.	Set “MEM. GUARD” to “OFF”.	56
<b>This unit does not operate properly.</b>	The internal microcomputer has been frozen by an external electric shock (such as lightning or excessive static electricity) or by a power supply with low voltage.	Disconnect the power cable from the AC wall outlet and then plug it in again after about 30 seconds.	—
<b>“CHECK SP WIRES” appears in the front panel display.</b>	Speaker cables are short-circuited.	Make sure all speaker cables are connected correctly.	11
<b>There is noise interference from digital or radio frequency equipment.</b>	This unit is too close to the digital or high-frequency equipment.	Move this unit further away from such equipment.	—
<b>The picture is disturbed.</b>	The video source uses scrambled or encoded signals to prevent dubbing.		
<b>This unit suddenly enters the standby mode.</b>	The internal temperature becomes too high and the overheat protection circuitry has been activated.	Wait about 1 hour for this unit to cool down and then turn it back on.	—

## ■ Tuner

	Problem	Cause	Remedy	See page
FM	<b>FM stereo reception is noisy.</b>	The characteristics of FM stereo broadcasts may cause this problem when the transmitter is too far away or the antenna input is poor.	Check the antenna connections.	18
			Try using a high-quality directional FM antenna.	—
			Use the manual tuning method.	36
	<b>There is distortion, and clear reception cannot be obtained even with a good FM antenna.</b>	There is multi-path interference.	Adjust the antenna position to eliminate multi-path interference.	—
	<b>The desired station cannot be tuned into with the automatic tuning method.</b>	The signal is too weak.	Use a high-quality directional FM antenna.	—
			Use the manual tuning method.	36
	<b>Previously preset stations can no longer be tuned into.</b>	This unit has been disconnected for a long period.	Set preset stations.	37, 38
AM	<b>The desired station cannot be tuned into with the automatic tuning method.</b>	The signal is weak or the antenna connections are loose.	Tighten the AM loop antenna connections and orient it for the best reception.	—
			Use the manual tuning method.	36
	<b>There are continuous crackling and hissing noises.</b>	Noises result from lightning, fluorescent lamps, motors, thermostats and other electrical equipment.	Use an outdoor antenna and a ground wire. This will help somewhat, but it is difficult to eliminate all noise.	—
	<b>There are buzzing and whining noises.</b>	A TV set is being used nearby.	Move this unit away from the TV set.	—

## ■ XM Satellite Radio (U.S.A. model only)

If an operation takes longer than usual or an error occurs, one of the following messages may appear in the front panel display. In this case, read the cause and follow the corresponding remedies.

Status message	Cause	Remedy	See page
CHECK ANTENNA	The XM Connect-and-Play digital antenna is not connected to the XM jack of this unit or does not work properly.	Check the XM Connect-and-Play digital antenna connections and orient it for the best reception level.	41
UPDATING	The XM user encryption code is being updated.	Wait until the encryption code is updated.	—
NO SIGNAL	The signal is too weak.	Check the XM Connect-and-Play digital antenna connections and orient it for the best reception level.	41
LOADING	It takes longer than four seconds for audio or text data to be decoded.	Wait until the decoding process has finished.	—
OFF AIR	The XM Satellite Radio channel you selected is not currently broadcasting any signals.	Check the channel number again or select another XM Satellite Radio channel.	—
<XM> - - -	The Channel Station ID (SID) is no longer available.		
- - - / - - -	No artist name or song title is available.		
<CAT> - - -	No channels are available for the selected category.	Select another channel category by pressing CATEGORY on the front panel (or A-E/CAT. </> on the remote control) repeatedly.	46

## ■ Remote control

Problem	Cause	Remedy	See page	
<b>The remote control does not work nor function properly.</b>	Wrong distance or angle.	The remote control functions within a maximum range of 6 m (20 ft) and no more than 30 degrees off-axis from the front panel.	7	
	Direct sunlight or lighting (from an inverter type of fluorescent lamp, etc.) is striking the remote control sensor of this unit.	Reposition this unit.	—	
	The batteries are weak.	Replace all batteries.	3	
	The remote control code is not correctly set.	Set the remote control code correctly using "LIST OF REMOTE CONTROL CODES" at the end of this manual.		59
		Try setting another code for the same manufacturer using "LIST OF REMOTE CONTROL CODES" at the end of this manual.		59
Even if the remote control code is correctly set, there are some models that do not respond to the remote control.				

# RESETTING THE SYSTEM

Use this feature to reset all the parameters of this unit to the initial factory settings.

## Notes

- This procedure completely resets all the parameters of this unit including the “SET MENU” parameters.
- The initial factory settings are activated next time you turn on this unit.

 To cancel the initialization procedure at any time without making any changes, press STRAIGHT repeatedly to select “CANCEL” and then press STANDBY/ON on the front panel.

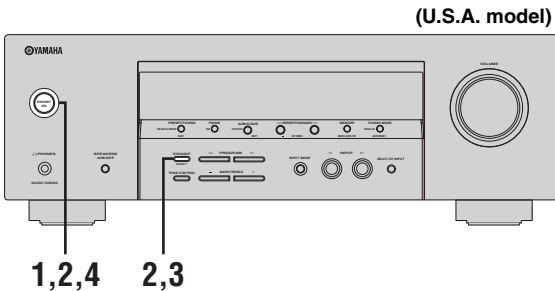

- 1 Press STANDBY/ON on the front panel to set this unit to the standby mode.**



- 2 Press and hold STRAIGHT on the front panel and then press STANDBY/ON to turn on this unit.**

The advanced setup menu appears in the front panel display.

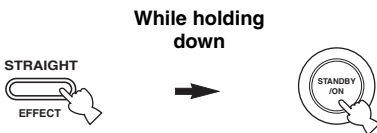

- 3 Press STRAIGHT on the front panel repeatedly to select “RESET”.**

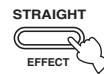

PRESET -RESET

Select “CANCEL” to cancel the initialization procedure without making any changes.

- 4 Press STANDBY/ON on the front panel to confirm your selection and set this unit to the standby mode.**



# GLOSSARY

## Audio information

### ■ **Dolby Digital**

Dolby Digital is a digital surround sound system that gives you completely independent multi-channel audio. With 3 front channels (front L/R and center), and 2 surround stereo channels, Dolby Digital provides 5 full-range audio channels. With an additional channel especially for bass effects, called LFE (Low Frequency Effect), the system has a total of 5.1-channels (LFE is counted as 0.1 channel). By using 2-channel stereo for the surround speakers, more accurate moving sound effects and surround sound environment are possible than with Dolby Surround. The wide dynamic range from maximum to minimum volume reproduced by the 5 full-range channels and the precise sound orientation generated using digital sound processing provide listeners with unprecedented excitement and realism. With this unit, any sound environment from monaural up to a 5.1-channel configuration can be freely selected for your enjoyment.

### ■ **Dolby Pro Logic II**

Dolby Pro Logic II is an improved technique used to decode vast numbers of existing Dolby Surround sources. This new technology enables a discrete 5-channel playback with 2 front left and right channels, 1 center channel, and 2 surround left and right channels instead of only 1 surround channel for conventional Pro Logic technology. There are three modes available: "Music mode" for music sources, "Movie mode" for movie sources and "Game mode" for game sources.

### ■ **Dolby Surround**

Dolby Surround uses a 4-channel analog recording system to reproduce realistic and dynamic sound effects: 2 front left and right channels (stereo), a center channel for dialog (monaural), and a surround channel for special sound effects (monaural). The surround channel reproduces sound within a narrow frequency range. Dolby Surround is widely used with nearly all video tapes and laser discs, and in many TV and cable broadcasts as well. The Dolby Pro Logic decoder built into this unit employs a digital signal processing system that automatically stabilizes the volume on each channel to enhance moving sound effects and directionality.

### ■ **DTS (Digital Theater Systems) Digital Surround**

DTS digital surround was developed to replace the analog soundtracks of movies with a 5.1-channel digital sound track, and is now rapidly gaining popularity in movie theaters around the world. Digital Theater Systems Inc. has developed a home theater system so that you can enjoy the depth of sound and natural spatial representation of DTS digital surround in your home. This system produces practically distortion-free 5.1-channel sound (technically, left, right and center channels, 2 surround channels, plus an LFE 0.1 channel as a subwoofer, for a total of 5.1-channels).

### ■ **ITU-R**

ITU-R is the radio communication sector of the ITU (International Telecommunication Union). ITU-R recommends a standard speaker placement which is used in many critical listening rooms, especially for mastering purposes.

### ■ **LFE 0.1 channel**

This channel reproduces low-frequency bass signals. The frequency range of this channel is from 20 Hz to 120 Hz. This channel is counted as 0.1 because it only enforces a low-frequency range compared to the full-range reproduced by the other 5 channels in Dolby Digital or DTS 5.1-channel systems.

### ■ **PCM (Linear PCM)**

Linear PCM is a signal format under which an analog audio signal is digitized, recorded and transmitted without using any compression. This is used as a method of recording CDs and DVD audio. The PCM system uses a technique for sampling the size of the analog signal per very small unit of time. Standing for "Pulse Code Modulation", the analog signal is encoded as pulses and then modulated for recording.

### ■ **Sampling frequency and number of quantized bits**

When digitizing an analog audio signal, the number of times the signal is sampled per second is called the sampling frequency, while the degree of fineness when converting the sound level into a numeric value is called the number of quantized bits. The range of rates that can be played back is determined based on the sampling rate, while the dynamic range representing the sound level difference is determined by the number of quantized bits. In principle, the higher the sampling frequency, the wider the range of frequencies that can be played back, and the higher the number of quantized bits, the more finely the sound level can be reproduced.

## ***Sound field program information***

### ■ **CINEMA DSP**

Since the Dolby Surround and DTS systems were originally designed for use in movie theaters, their effect is best felt in a theater having many speakers designed for acoustic effects. Since home conditions, such as room size, wall material, number of speakers, and so on, can differ so widely, it is inevitable that there are differences in the sound heard. Based on a wealth of actually measured data, YAMAHA CINEMA DSP uses YAMAHA original DSP technology to combine Dolby Pro Logic, Dolby Digital and DTS systems to provide the audiovisual experience of movie theater in the listening room of your own home.

### ■ **SILENT CINEMA**

YAMAHA has developed a natural, realistic sound effect DSP algorithm for headphones. Parameters for headphones have been set for each sound field program so that accurate representations of all the sound field programs can be enjoyed on headphones.

### ■ **Virtual CINEMA DSP**

YAMAHA has developed a Virtual CINEMA DSP algorithm that allows you to enjoy DSP surround effects even without any surround speakers by using virtual surround speakers. It is even possible to enjoy Virtual CINEMA DSP using a minimal two-speaker system that does not include a center speaker.

## ***Video information***

### ■ **Component video signal**

With the component video signal system, the video signal is separated into the Y signal for the luminance and the P<sub>B</sub> and P<sub>R</sub> signals for the chrominance. Color can be reproduced more faithfully with this system because each of these signals is independent. The component signal is also called the "color difference signal" because the luminance signal is subtracted from the color signal. A monitor with component input jacks is required in order to output component signals.

### ■ **Composite video signal**

With the composite video signal system, the video signal is composed of three basic elements of a video picture: color, brightness and synchronization data. A composite video jack on a video component transmits these three elements combined.

# SPECIFICATIONS

## AUDIO SECTION

- Minimum RMS Output Power for Front, Center, Surround  
[U.S.A. and Canada models]  
1 kHz, 0.9% THD, 8  $\Omega$ /6  $\Omega$  ..... 110 W  
[Other models]  
1 kHz, 0.9% THD, 6  $\Omega$  ..... 100 W
- Maximum Output Power  
[Europe model]  
1 kHz, 0.7% THD, 4  $\Omega$  ..... 105 W
- Maximum Power  
[Asia, China, Korea and General models]  
1 kHz, 10% THD, 6  $\Omega$  ..... 110 W
- Dynamic Power  
[U.S.A. and Canada models] (Impedance Selector: 8  $\Omega$ )  
(IHF, 8/6/4/2  $\Omega$ ) ..... 120/140/160/180 W  
[Other models]  
(IHF, 6/4/2  $\Omega$ ) ..... 105/135/165 W
- Frequency Response  
CD, etc. to Front L/R ..... 10 Hz to 100 kHz, -3 dB
- Total Harmonic Distortion  
1 kHz, 50 W, 6  $\Omega$ , Front L/R ..... 0.06% or less
- Signal to Noise Ratio (IHF-A Network)  
CD (250 mV) to Front L/R, Effect Off ..... 100 dB or more
- Residual Noise (IHF-A Network)  
Front L/R ..... 150  $\mu$ V or less
- Channel Separation (1 kHz/10 kHz)  
CD, etc. (5.1 k $\Omega$  terminated) to Front L/R  
..... 60 dB/45 dB or more
- Tone Control (Front L/R)  
BASS Boost/Cut .....  $\pm$ 10 dB/100 Hz  
TREBLE Boost/Cut .....  $\pm$ 10 dB/20 kHz
- Phones Output ..... 400 mV/470  $\Omega$
- Input Sensitivity/Input Impedance  
CD, etc. .... 200 mV/47 k $\Omega$   
MULTI CH INPUT ..... 200 mV/47 k $\Omega$
- Output Level/Output Impedance  
AUDIO OUT (REC) ..... 200 mV/1.2 k $\Omega$   
SUBWOOFER OUTPUT ..... 4 V/1.2 k $\Omega$

## VIDEO SECTION

- Video Signal Type  
[U.S.A., Canada, Korea and General models] ..... NTSC  
[Other models] ..... PAL
- Component Signal Level ..... 1 V<sub>p-p</sub>/75  $\Omega$
- Signal to Noise Ratio ..... 50 dB or more
- Frequency Response (MONITOR OUT)  
Video Signal ..... 5 Hz to 10 MHz, -3 dB  
Component Signal ..... 5 Hz to 60 MHz, -3 dB

## FM SECTION

- Tuning Range  
[U.S.A. and Canada models] ..... 87.5 to 107.9 MHz  
[Other models] ..... 87.50 to 108.00 MHz
- 50 dB Quieting Sensitivity (IHF, 100% mod.)  
Mono ..... 2.8  $\mu$ V (20.2 dBf)
- Signal to Noise Ratio (IHF)  
Mono/Stereo ..... 73 dB/70 dB
- Harmonic Distortion (1 kHz)  
Mono/Stereo ..... 0.5%/0.5%

## AM SECTION

- Tuning Range  
[U.S.A. and Canada models] ..... 530 to 1710 kHz  
[Asia and General models] ..... 530/531 to 1710/1611 kHz  
[Other models] ..... 531 to 1611 kHz

## GENERAL

- Power Supply  
[U.S.A. and Canada models] ..... 120 V AC, 60 Hz  
[Australia model] ..... 240 V AC, 50 Hz  
[U.K. and Europe models] ..... 230 V AC, 50 Hz  
[Korea model] ..... 220 V AC, 60 Hz  
[China model] ..... 220 V AC, 50 Hz  
[Asia and General models]  
..... 110-120/220-240 V AC, 50/60 Hz
- Power Consumption  
[U.S.A. and Canada models] ..... 240 W/320 VA  
[Other models] ..... 240 W
- Standby Power Consumption  
[U.S.A. and Canada models] ..... 0.5 W  
[Other models] ..... 0.7 W
- Dimensions (W x H x D) ..... 435 x 151 x 315 mm  
(17-1/8" x 5-15/16" x 12-7/16")
- Weight ..... 9.0 kg (19 lbs 13 oz)

\* Specifications are subject to change without notice.



## LIST OF REMOTE CONTROL CODES

### TV

ADMIRAL 292, 293  
AIWA 294, 276, 283, 284  
AKAI 295, 296  
ALBA 296  
AOC 297  
BELL&HOWELL 292  
BESTAR 298  
BLAUPUNKT 229, 222  
BLUE SKY 298  
BRANDT 223  
BROCSONIC 297  
BUSH 296  
CLATRONIC 298  
CRAIG 224  
CROSLEX 225  
CURTIS MATHIS 297, 226  
DAEWOO 297, 298, 224, 227, 228  
DAYTRON 239  
DUAL 298  
DWIN 293  
EMERSON 297, 224, 239, 232  
FERGUSON 223, 265, 266  
FIRST LINE 298  
FISHER 295, 233  
FRABA 298  
FUNAI 277, 278  
GE 293, 297, 234, 235, 236  
GOODMANS 296, 298, 223  
GRUNDIG 229, 238, 249  
HITACHI 297, 239, 242, 243, 285  
ICE 296  
IRRADIO 296  
ITT/NOKIA 244, 245  
JC PENNY 293, 297, 234, 237  
JVC 296, 246, 247, 286  
KENDO 298  
KTV 297, 239  
LG/GOLDSTAR 297, 298, 239, 237  
LOEWE 298, 248  
LXI 293, 297, 225, 226, 233  
MAGNAVOX 297, 225, 239  
MARANTZ 298  
MATSUI 295  
MEMOREX 297  
MITSUBISHI 299, 297, 259, 287  
NEC 297, 252, 282  
NOKIA 244, 245  
NOKIA OCEANIC 245  
NORDMENDE 265, 266  
ONWA 296

PANASONIC 234, 235, 236, 253, 288, 211  
PHILCO 297, 225, 239  
PHILIPS 225  
PIONEER 226, 235, 254, 255, 268  
PORTLAND 297, 256  
PROSCAN 293  
PROTON 297  
QUASAR 234, 235  
RADIO SHACK 299, 293, 297  
RCA 293, 297, 234, 256, 257, 258  
SABA 223, 269, 265, 266  
SAMPO 297  
SAMSUNG 297, 239, 248, 262, 275  
SANYO 295, 233, 279, 272, 273, 274, 212  
SCHNEIDER 296  
SCOTT 297  
SHARP 292, 239, 232, 213, 216  
SIEMENS 229  
SIGNATURE 292  
SONY 263, 214  
SYLVANIA 297, 225  
TELEFUNKEN 269, 264, 265, 266  
THOMSON 223, 266  
TOSHIBA 292, 226, 267, 215  
VIDECH 297, 242  
WARDS 297, 239, 232  
YAMAHA 299, 292, 253, 242

### VCR

ADMIRAL 395  
AIWA 396, 397, 398, 329  
AKAI 322, 323, 324  
AUDIO DYNAMIC 392, 394  
BELL&HOWELL 393  
BLAUPUNKT 325, 326  
BROCSONIC 327  
BUSH 322  
CANON 325, 328  
CGM 396, 332  
CITIZEN 396  
CRAIG 396, 363  
CURTIS MATHIS 397, 328, 333  
DAEWOO 328, 334, 335  
DBX 392, 394  
DIMENSIA 333  
DYNATECH 397  
EMERSON 327, 334, 396, 397  
FISHER 393, 336  
FUNAI 397  
GE 328, 333, 387

GO VIDEO 353  
GOODMANS 334, 337  
GRUNDIG 332, 338  
HITACHI 325, 333, 349, 342, 343  
INSTANT REPLAY 325, 328  
ITT/NOKIA 393  
JC PENNY 392, 393, 394, 328, 333, 349, 396, 363  
JVC 392, 394, 344, 345, 346, 347  
KENDO 396  
KENWOOD 392, 394, 396  
LG/GOLDSTAR 396, 388  
LOEWE 396, 337  
LUXOR 395  
LXI 393, 396, 397, 336, 349  
MAGNAVOX 325, 326, 328  
MARANTZ 392, 394  
MARTA 396  
MATSUI 396  
MEMOREX 328, 336, 396, 397  
MINOLTA 333, 349  
MITSUBISHI 399, 344, 348, 359, 352, 353  
MTC 363, 397  
MULTITECH 397, 348, 354  
NEC 392, 394, 344, 383  
NOKIA 393, 395  
NOKIA OCEANIC 395  
OKANO 323  
OLYMPIC 325, 328  
ORION 327  
PANASONIC 325, 328, 355, 378, 384, 385, 386  
PENTAX 333, 349  
PHILCO 325, 328, 397  
PHILIPS 325, 326, 328, 337, 356, 357  
PHONOLA 337  
PILOT 396  
PIONEER 325  
QUASAR 325, 328  
RCA/PROSCAN 325, 326, 328, 333, 335, 349, 358, 369, 363, 397  
REALISTIC 393, 397, 328, 336, 359, 362, 396, 363  
SAMSUNG 354, 358, 363, 364, 365, 366  
SANSUI 394  
SANYO 393, 336, 367  
SCHNEIDER 337  
SCOTT 399, 335, 336, 348, 359, 352, 354, 358  
SELECO 322  
SHARP 395, 362, 382

SIEMENS 393  
SIGNATURE 2000 395, 397  
SONY 368, 379, 372, 373, 374, 375  
SYLVANIA 397, 325, 326, 328  
SYMPHONIC 397  
TANDBERG 334  
TANDY 397  
TASHIRO 396  
TATUNG 392, 394  
TEAC 392, 394, 397  
TECHNICS 325, 328  
TEKNIKA 396  
TELEFUNKEN 376, 377  
THOMAS 397  
THORN 393, 396  
TOSHIBA 335, 369, 389  
TOTEVISON 363, 396  
UNITECH 363  
UNIVERSUM 396, 327, 376  
VIDEOSONIC 363  
W.WHOUSE 396  
WARDS 395, 396, 336, 362  
YAMAHA 399, 392, 393, 394  
ZENITH 344, 368, 379, 396, 397

### DVD player

DENON 623, 624  
FUNAI 625  
HITACHI 626  
JVC 627  
KENWOOD 628  
LG/GOLD STAR 645  
MITSUBISHI 629  
ONKYO 632, 633, 634  
PANASONIC 623, 635  
PHILIPS 699, 647  
PIONEER 636, 637, 638  
RCA 639  
SAMSUNG 642  
SHARP 643  
SONY 644  
THOMSON 646  
TOSHIBA 634  
YAMAHA 699, 622, 623, 647

### MD player

YAMAHA 599

### CD player

YAMAHA 199

### CD recorder

YAMAHA 499



© 2006 YAMAHA CORPORATION All rights reserved.

**YAMAHA ELECTRONICS CORPORATION, USA** 6660 ORANGETHORPE AVE., BUENA PARK, CALIF. 90620, U.S.A.  
**YAMAHA CANADA MUSIC LTD.** 135 MILNER AVE., SCARBOROUGH, ONTARIO M1S 3R1, CANADA  
**YAMAHA ELECTRONIK EUROPA G.m.b.H.** SIEMENSSTR. 22-34, 25462 RELLINGEN BEI HAMBURG, GERMANY  
**YAMAHA ELECTRONIQUE FRANCE S.A.** RUE AMBROISE CROIZAT BP70 CROISSY-BEAUBOURG 77312 MARNE-LA-VALLEE CEDEX02, FRANCE  
**YAMAHA ELECTRONICS (UK) LTD.** YAMAHA HOUSE, 200 RICKMANSWORTH ROAD WATFORD, HERTS WD18 7GQ, ENGLAND  
**YAMAHA SCANDINAVIA A.B.** J A WETTERGRENS GATA 1, BOX 30053, 400 43 VÄSTRA FRÖLUNDA, SWEDEN  
**YAMAHA MUSIC AUSTRALIA PTY, LTD.** 17-33 MARKET ST., SOUTH MELBOURNE, 3205 VIC., AUSTRALIA

**YAMAHA CORPORATION**  
Printed in China  WG72080