

SEARS Kenmore

OWNER'S MANUAL

MODEL NO.

911. 91461

911. 91468

911. 91761

911. 91765

911. 91768

911. 92761

911. 92768

CAUTION:

*Read and Follow All Safety
Rules and Operating
Instructions Before First
Use of This Product*

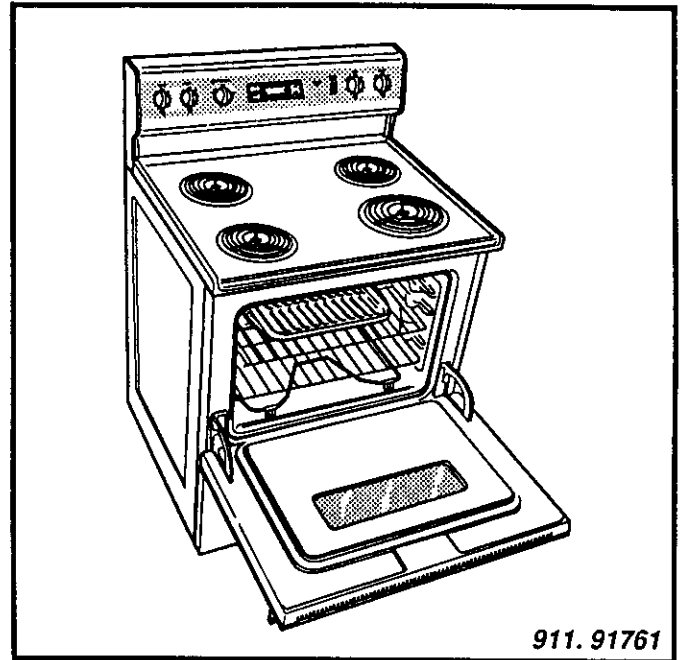

30" ELECTRIC FREE-STANDING RANGE

- *Safety Instructions*
- *Features*
- *Operation*
- *Care and Cleaning*
- *Problem Solving*
- *Easy Adjustment*
- *Consumer Service*

Sears, Roebuck and Co., Hoffman Estates, IL 60179 U.S.A.

229C4020P085(31-10205)

ELECTRIC FREE-STANDING TABLE OF CONTENTS



SAFETY INSTRUCTIONS

Range Safety	3-5
Stability Device	3

INTRODUCING YOUR RANGE

Features of Your Range	6
Removal of Packaging Tape	6

COOKTOP COOKING

Cooking Elements	7
Control Settings	7
Home Canning	7

CLOCK AND KITCHEN TIMER

How To Set The Clock	8
How To Set The Timer	8
How To Reset The Timer	8
How To Cancel The Timer	8
End-of-Cycle Tone	8

USING YOUR OVEN

Oven Cooking Tips	9-11
Strong Smell or Odor	9
No Peeking	9
Aluminum Foil	9
Preheating	9
Oven Light	9
Temperature Sensor	9
Oven Vent	9
Moisture	10

Bakeware	10
Bakeware Placement	10
Element Cycling	10
Oven Racks	11
Oven Temperature Adjustment	11, 20
How to Set Bake	11
To Set Roast	11

Broiling	12
General Rules	12
Preparing Meats	12
Oven Rack Position	12
How to Set Broil	12

CLEANING

Control Panel	13
Broiler Pan and Grid	13
Porcelain Enamel Cooktop	13
Burner Box Bottom	13
Painted Surface	13
Oven Interior	13
Glass	13

REMOVABLE PARTS

Oven Racks	15
Oven Door	15
Surface Control Knobs	14
Oven Light Bulb	14
Storage Drawer	16
Lift Up Cooktop	16
Cooktop Units	17

SERVICE

Before Calling for Service	18, 19
Consumer Service Numbers	21
Warranty	

For your convenience and future reference, please write down your model and serial number in the space provided. They are located on the front frame behind the storage drawer.

MODEL NUMBER:

SERIAL NUMBER

IMPORTANT INSTRUCTIONS FOR YOUR SAFETY



SAVE THESE INSTRUCTIONS

Read all instructions before using this appliance. When using gas or electrical appliances, basic safety precautions should be followed, including the following.

STABILITY DEVICE

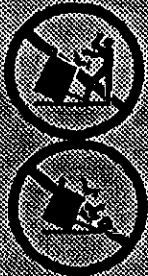

WARNING

- All Ranges Can Tip
- Injury To Persons Could Result
- Install Anti-tip Device Packed With Range
- See Installation Instructions

Tools you will need:

Phillips head screwdriver

1 3/8" open end or adjustable wrench

INSTALLATION OF THE ANTI-TIP DEVICE

1. Remove the bracket from the prepack located inside the oven.
2. Decide whether the bracket will be installed on the right or left side of range location.
3. If the bracket side of the range is adjacent to a cabinet, place the bracket against back wall and cabinet as shown below.

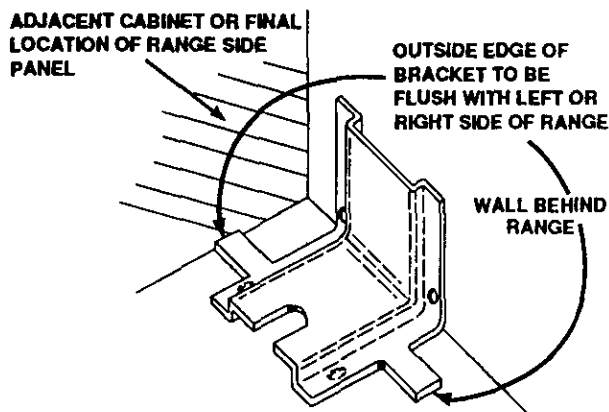

If there is no adjacent cabinet, determine where the location of the range side (painted outside panel) will be. Place the bracket with its outside edge at this location and against back wall. See illustration below.

4. Determine whether you will anchor the bracket to the floor or wall. Make sure this location is clear of electrical wiring or plumbing.
5. Fasten the bracket securely with the screws provided. Screws are self-drilling in wood, plywood, particle and chip board, and most metal framing. If attaching to masonry, you can buy suitable screws and anchors at hardware stores. Use a masonry drill to drill the required holes.

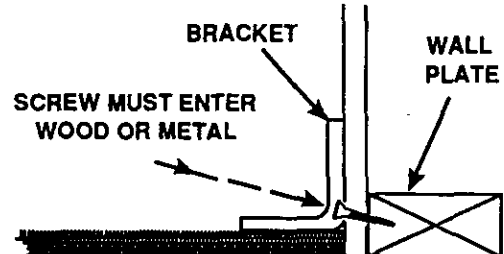

ATTACHMENT TO WALL

6. Using the wrench, back out the four leg levelers at least two turns. See your installation guide for more leveling information before positioning range.
7. Slide the range into place. Be sure rear leg leveler fully engages the slot in the bracket. If range cannot be moved back far enough for rear leg leveler to enter bracket, move bracket forward as required and attach to floor in new location.

IMPORTANT INSTRUCTIONS FOR YOUR SAFETY continued

To insure safety for yourself, family and home, please read your Owner's Manual carefully. Keep it handy for reference. Pay close attention to Safety Sections.

BE SURE your appliance is installed and grounded by a qualified technician.

WARNING!



To prevent accidental tipping of the range from abnormal usage, including excessive loading of the oven door, attach it to the wall or floor by installing the Anti-Tip device supplied. If the range is moved for cleaning, servicing or any reason, be sure the Anti-Tip device is re-engaged properly when the range is slid back in the opening. Failure to do so could result in the range tipping or personal injury.

TEACH CHILDREN

- Not to play with controls or any part of the appliance.
- Not to sit, climb or stand on the appliance door.



NEVER STORE items of interest to children in cabinets above the appliance.



KEEP THIS book for later use.

NEVER TRY to repair or replace any part of the appliance unless instructions are given in this manual. All other work should be done by a qualified technician.

NEVER USE your appliance for warming or heating the room.



ALWAYS KEEP combustible wall coverings, curtains and other linens a safe distance from the appliance.

NEVER HEAT unopened food containers. Pressure buildup can cause the container to burst and cause injury.

NEVER LEAVE jars or cans of fat or drippings in or near your appliance.

ALWAYS KEEP the appliance area free from things that will burn. Food, wooden utensils and grease buildup could catch fire. Plastic utensils could melt and canned foods could explode. Your appliance should never be used as a storage area.



ALWAYS KEEP your appliance clear of things that will burn (gasoline and other flammable vapors or liquids).



SOME CLEANERS produce noxious fumes and wet cloths or sponges could cause steam burns.

IMPORTANT INSTRUCTIONS FOR YOUR SAFETY continued

NEVER WEAR loose fitting clothing when using your appliance.

NEVER USE a towel or other bulky cloth as a pot holder and make sure the pot holder is dry. Moist pot holders could cause steam burns. Keep dish towels, dish cloths, pot holders and other linens a safe distance away from your appliance .



ALWAYS USE care when opening the oven door. Let hot air and steam escape before moving foods.

NEVER USE aluminum foil to line the oven bottom. Improper use of foil could start a fire.

COOKTOP SAFETY

ONLY SOME kinds of glass or ceramic cookware can be used for cooktop cooking. Make sure the cookware you choose to use is designed for cooktop cooking.

ALWAYS USE care when touching cooktop elements. They will retain heat after the range has been turned off.

NEVER BLOCK the oven air vent under the right rear element.

COOKWARE USED for cooktop cooking should be flat on the bottom and large enough to cover the heating area being used.



OVEN SAFETY

PLACE OVEN RACKS in the desired position while the oven is cool. If racks must be moved while oven is hot, do not let pot holder contact the hot oven element.

AFTER BROILING, always take the broiler pan and grid out of the oven and clean them. Leftover grease in the broiler pan could catch fire next time you use your oven.



READ AND UNDERSTAND THIS INFORMATION NOW!

Should you ever need it, you will not have time for reading. Be sure everyone in your home knows what to do in case of fire. Never use water on a grease fire; it will only spread the flames.

COOKTOP GREASE FIRE: Never pick up a flaming pan...

1. Turn off the surface elements.
2. Smother the flame with a tightly fitting lid, baking soda or an extinguisher.



OVEN FIRE:

Do not try to move the pan!

1. Close the oven door and turn controls off.
2. If fire continues, throw baking soda on the fire, or use a dry chemical, foam, or halon type extinguisher.



FEATURES OF YOUR NEW FREE-STANDING RANGE

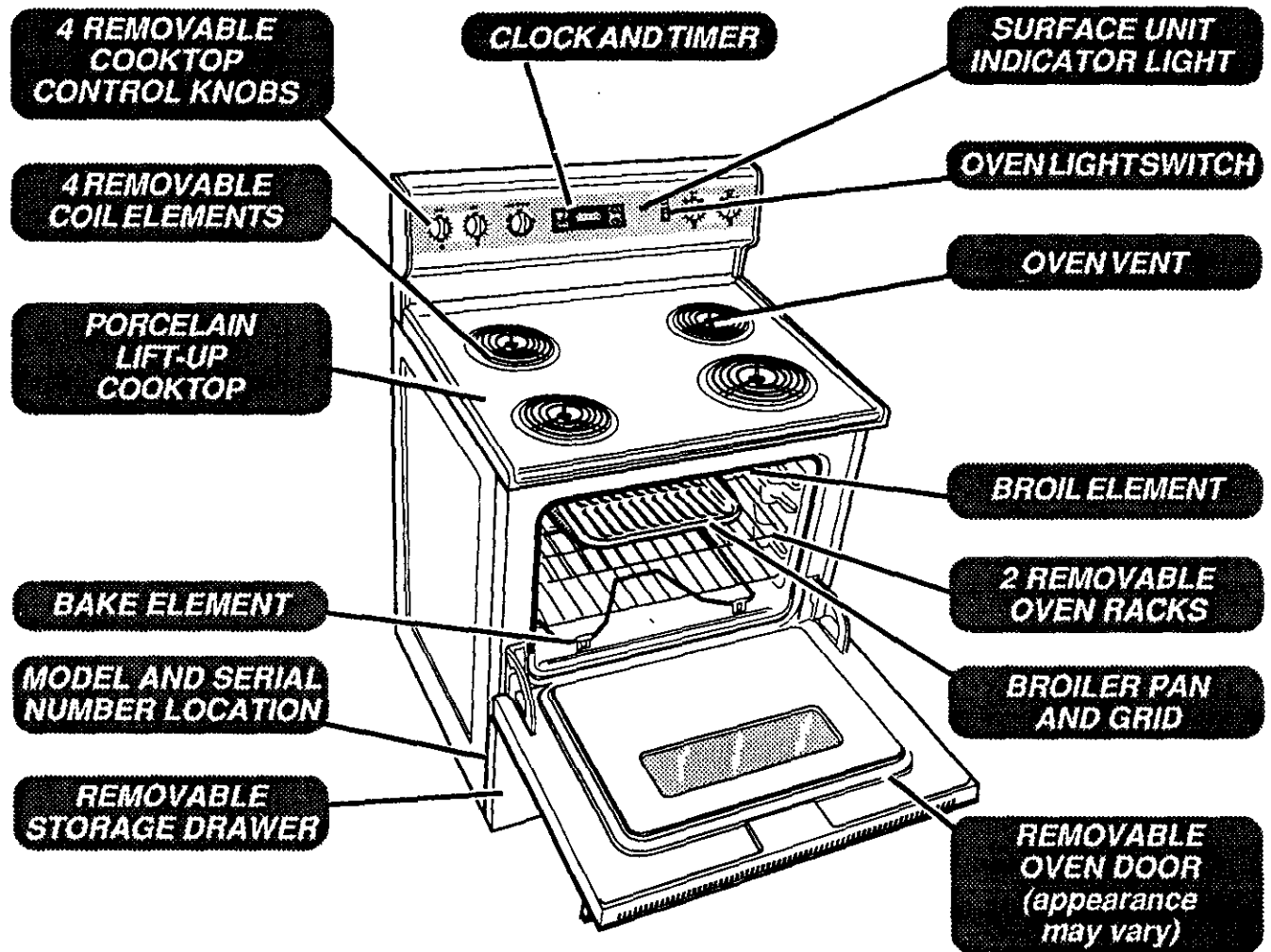

REMOVAL OF PACKAGING TAPE

To remove the adhesive left from packaging tape, use household dishwashing liquid, mineral oil or cooking oil. With a soft cloth rub into the area and allow to soak. Rinse and dry well. Repeat procedure using an appliance polish to insure no damage is done to the oven. **This should be done before the range is turned on for the first time. The tape cannot be removed once the oven has heated.**

Packaging tape can be found in the following areas:

Cooktop Surface

Control Panel Area

Door Handle

Door Trim

Oven Area

COOKTOP COOKING

COOKING ELEMENTS

Before using the cooktop for the first time, take a few moments to familiarize yourself with the elements and the knob used to turn on each element. The sign near each control knob shows you which element is turned on by that knob.

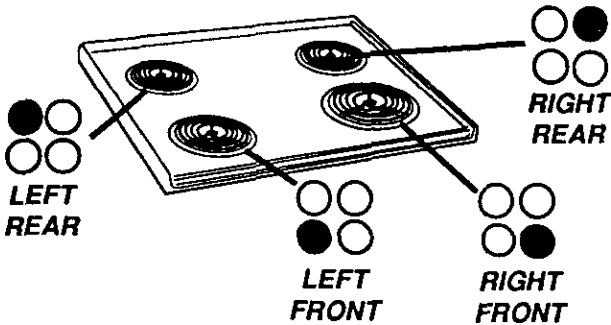

CONTROL SETTINGS

HI

Used for quick starts, such as bringing water to a boil.



MED

Used for slow boiling and sautéing.



LO

Used for steaming foods or keeping cooked foods at serving temperature.



1. Push down to turn the knob.

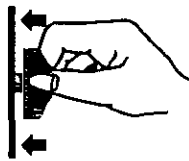

2. Set on or between marks for desired heat.

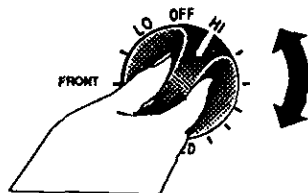

HOME CANNING TIPS

Water-bath or pressure canners and large diameter pots extending more than 1" beyond the edge of the cooktop element may be used for canning. This is because the temperature needed to boil water is not harmful to the surfaces surrounding the cooktop elements.

However, do not use large diameter canners, pots or pans for anything other than boiling water.

OBSERVE THE FOLLOWING POINTS WHEN CANNING

1. Be sure the canner is centered over the element.
2. Make sure the canner is flat on the bottom.



3. Use recipes and procedures from reputable sources. These are available from manufacturers such as Ball and Kerr and the Department of Agriculture Extension Service.
4. Use caution while canning, to prevent burns from steam or heat.



CAUTION: Never line the drip bowls with aluminum foil. Foil can block the normal heat flow and damage the range.

Always use cookware and woks that are flat on the bottom and the same size as the cooking element being used. Cookware should not extend more than 1" beyond the edge of the cooking element.

CLOCK AND TIMER

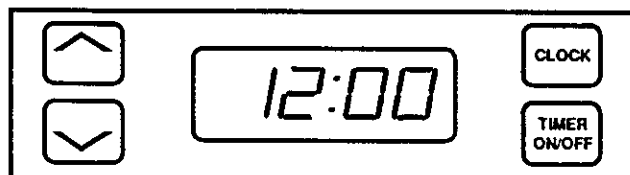
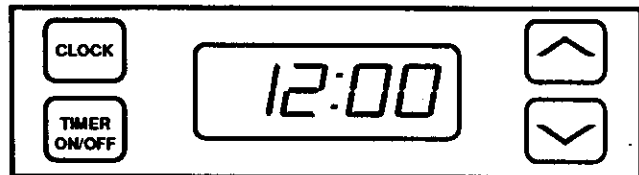

The **CLOCK** and **TIMER** are controlled with touch pads. They do not control any of the oven operations. (Appearance may vary.)

TO SET THE TIME OF DAY CLOCK

1. Press **CLOCK**.
2. Use the **UP** or **DOWN** touch pad to set the correct time of day.
3. The clock will start keeping time and the words "**SET TIME**" will disappear within the next 60 seconds.

TO RESET THE TIMER

To reset the timer during countdown use the **UP** or **DOWN** arrow pad. "**SET TIMER**" will flash and you can reset the **TIMER**. The **TIMER** will count down from the new time you select and "**SET**" will disappear in about 4 seconds.

SET THE TIMER

The **TIMER** displays hours and minutes. The maximum setting is 9 hours and 45 minutes on the **TIMER**. Seconds will be displayed during the countdown of the last minute only. The **TIMER** will beep when one minute remains in the countdown. Seconds will be displayed during the last minute countdown. "**HR:MIN**" will disappear from display.

1. Press **TIMER ON/OFF**. "**00**" appears and "**SET TIMER**" flashes. "**HR:MIN**" appears.
2. Select the desired time using the **UP** or **DOWN** touch pad. The **TIMER** will begin to count down and "**SET TIMER**" will disappear about 4 seconds after you select the time. If you do not wish to wait 4 seconds, press **TIMER** and the countdown will begin immediately.

TO CANCEL THE TIMER

If you wish to cancel the **TIMER** while it is counting down, press **TIMER ON/OFF**. The word "**TIME**" will disappear from the display and the display will return to the time of day. If you wish to cancel the **TIMER** while "**SET TIMER**" is flashing in the display, press **TIMER ON/OFF** twice.

END-OF-CYCLE TONE

The **END-OF-CYCLE** tone will sound when the **TIMER** countdown is complete. The display will show "**00**" and you will hear a series of beeps. Press **TIMER ON/OFF** or **CLOCK** to stop the tone.

OVEN COOKING TIPS

STRONG SMELL OR ODOR

It is normal to have some odor when using your oven for the first time. This is caused by the heating of new parts and insulation.

To help eliminate this odor, **ventilate the room by opening a window or using a vent hood.**

ALUMINUM FOIL

IMPORTANT:

Never cover the oven bottom or oven rack with aluminum foil. Improper use can cause poor heat flow, poor baking results, and may damage the oven finish.

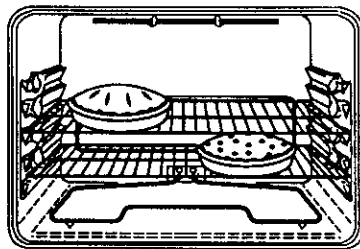

OVEN VENT

The oven vent is located under the right rear element. This area could become very hot during oven use. The vent is important for proper air circulation. **Never block this vent.**

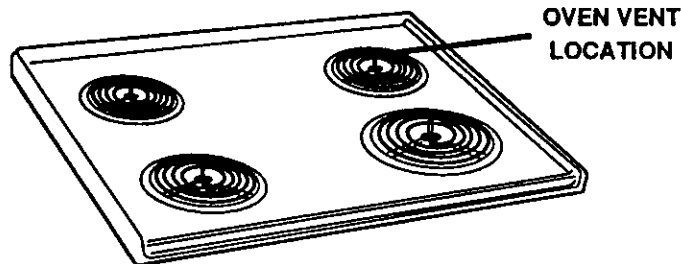

PREHEATING

Let the oven preheat thoroughly when recipes call for preheating. Preheating is bringing the temperature up to the temperature you will be using during baking. When the oven has reached the preheat temperature, the indicator light will turn off. Have foods nearby ready to place in the oven.

OVEN TEMPERATURE SENSOR

In the back of the oven you will notice a small tube. This is a heat sensor that maintains the temperature of the oven. Never move or bend this tube.

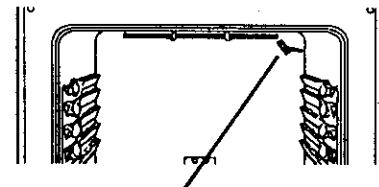

OVEN TEMPERATURE SENSOR

NO PEEKING

Opening the door often to check foods will cause heat loss and poor baking results.

OVEN COOKING TIPS *continued*

BAKEWARE

FLAT COOKIE SHEETS

(without sides)

Flat cookie sheets allow air to circulate all around the cookies for even browning.

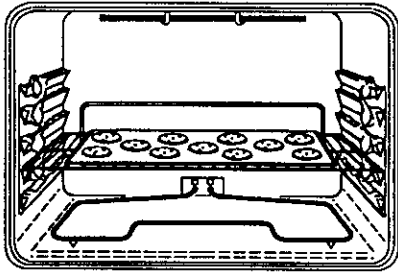

SHINY PANS

(reflect heat)

Shiny pans are perfect for cakes and quick breads that have a golden brown crust.

GLASS, DARK NON-STICK, OR DARKENED BY AGE BAKEWARE

(absorb heat)

Perfect for yeast breads, pie crust or foods that have a brown crust. The oven temperature should be reduced by 25°F.

MOISTURE

As the oven heats, the change in temperature inside the oven causes water droplets to form on the oven door glass. To prevent this, open the door momentarily to allow the moist air out.

BAKEWARE PLACEMENT

If baking with more than one pan, place the pans so each has at least 1 to 1 1/2" of air space around it. Place pans so one is not directly above the other.

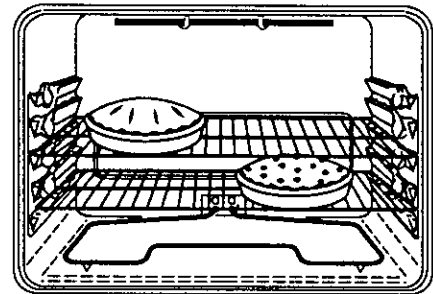

ELEMENT CYCLING

The Oven Temperature Sensor at the back of the oven continuously senses and controls the temperature inside the oven. To keep a constant set temperature, the elements will cycle or turn on and off during cooking.

OVEN COOKING TIPS *continued*

OVEN RACKS

The oven racks are designed with stop locks, a convenience as well as a safety precaution for placing foods in or removing foods from the oven. When the racks are placed correctly in the oven, the guides have a bump to prevent the racks from tilting. Your oven has four (4) rack positions that may be used during cooking.

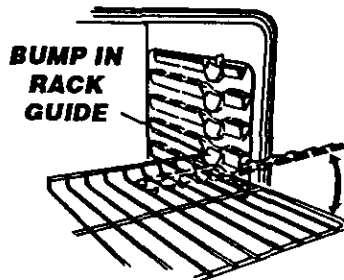

The top position is only a guide. It cannot be used as a rack position.

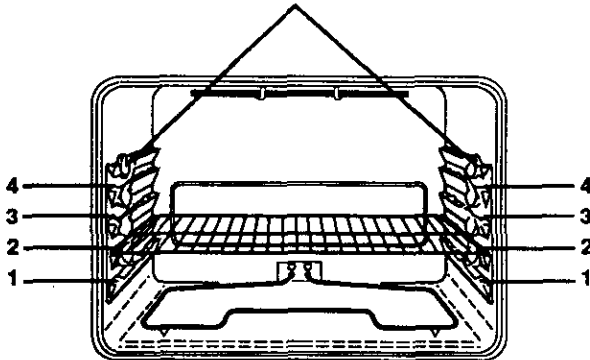

Always place oven racks in the proper position while oven is cool.

OVEN TEMPERATURE ADJUSTMENT

You may feel that your new oven cooks differently than the oven it replaced. We recommend that you use your new oven a few weeks to become more familiar with it, following the times given in your recipes as a guide. See *Do It Yourself Adjustment* at the back of this manual to make the adjustment if you feel your oven is too hot or too cool for your cooking preference.

TO SET BAKE

1. Set the **OVEN CONTROL KNOB** to the desired temperature.
2. When baking is finished, turn the **OVEN CONTROL KNOB** to the "OFF" position.



TO SET ROAST

Roasting is cooking tender cuts of meats with dry heat. It is not necessary to preheat your oven before roasting.

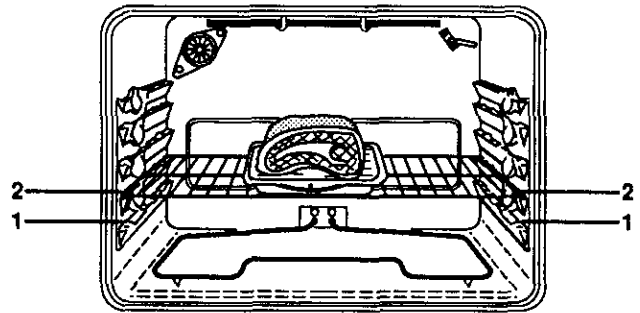

GENERAL ROASTING INSTRUCTIONS

1. Place meat (fatty side up) on a roasting rack or in a shallow pan about the same size of the meat.
2. Place pan in No. 1 or No. 2 rack position.
3. Set the **OVEN CONTROL KNOB** to the desired temperature.

Remember:

Most meats continue to cook internally after being taken out of the oven.

BROILING

GENERAL RULES

Broiling is cooking by direct heat from the upper element.

The oven door should remain opened to the broil stop position during broiling.

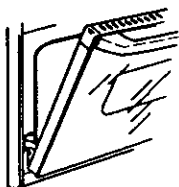

It is not necessary to preheat the oven when broiling. Use the broiler pan and grid that came with your range. Both are designed for proper drainage of fat and liquids.



Foil must be molded tightly to the grid and slits cut into the foil to match those of the grid. This allows fats and liquids to drain into the broiler pan, preventing fire and excessive smoke.

Always remove the pan and grid from the oven. Storing or forgetting a soiled broiler pan in the oven is a potential smoke or fire hazard.



PREPARING MEATS FOR BROILING

- Choose tender cuts of meat at least 3/4" thick for broiling.
- Trim the outer layer of fat, slit the edges to keep meats from curling.
- Always use tongs to turn meats. Piercing meat allows juices to escape.
- Salt the first side of meats just before turning, the second side just before serving. Brush chicken and fish with butter several times as they broil.
- Chicken and fish should be placed on the grid skin side down. For fish, lightly grease the grid to prevent sticking.

The U.S. Department of Agriculture notes that meat cooked rare is popular, but meat cooked to only 140°F (rare) means that some poisoning organisms may survive.

The closer you place foods to the broil element, the faster foods brown on the outside yet remain red to pink in the center.

Moving meats away from the element will allow the meat to cook to the center while browning on the outside. Using this positioning, cook side 1 at least 2 minutes longer than side 2. If your oven is connected to 208 volts, you may want to use a higher rack position and/or broil foods longer.

The size, weight, thickness, starting temperature and your preference of the doneness of the meat will affect broiling. This chart is based on meats at refrigerator temperature.

FOOD	RACK POSITION	TOTAL TIME (MIN.)
Steak 1" thick	3	21-23
Ground beef patties 1" thick	3	16-18
Pork Chops- 1/2" thick	3	27-29
Fish (fillets)	3	11-13
Chicken (pieces)	2	45-55

HOW TO SET BROIL

TO SET BROIL:

1. Set the **OVEN CONTROL KNOB** to **BROIL**.

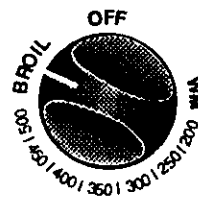

2. When broiling is finished, turn the **OVEN CONTROL KNOB** to the **"OFF"** position.

CLEANING

CONTROL PANEL

CLEANING MATERIALS TO USE:

- Dishwashing detergent
- Warm water
- Soft cloth

Do not use abrasive cleaners, industrial cleaners, or bleach.

BROILER PAN AND GRID

CLEANING MATERIALS TO USE:

- Dishwashing detergent
- Warm water
- Soap-filled steel wool pad
- Commercial oven cleaner



TO CLEAN:

Allow the pan to soak. Sprinkle the grid with dishwashing detergent and cover with a damp cloth or paper towel and let stand. Scour as needed. Wash, rinse, and dry well. You may also place both the pan and grid in the dishwasher.

PORCELAIN ENAMEL COOKTOP AND BURNER BOX BOTTOM:

CLEANING MATERIALS TO USE:

- Dishwashing detergent
- Warm water
- Paper towel
- Ammonia
- Abrasive cleaner
- Scouring pad

TO CLEAN

Clean after each use. If acidic foods (hot fruit filling, milk, tomatoes, sauerkraut or sauces with vinegar or lemon juice) spill, use a dry paper towel to wipe up as much as possible. When surface has cooled thoroughly clean cooktop.

PAINTED SURFACES

CLEANING MATERIALS TO USE:

- Dishwashing detergent
- Warm water
- Paper towels

TO CLEAN

Do not use oven cleaners, cleansing powder, or harsh abrasives. If marinades, tomato sauce, basting materials, etc. should spill, wipe up as much as possible. When surfaces have cooled thoroughly clean painted areas.

OVEN INTERIOR

CLEANING MATERIALS TO USE:

- Oven cleaner

TO CLEAN

Clean up after each oven use. Rinse thoroughly. Do not coat bake or broil element with oven cleaner. When using oven cleaner read directions on container carefully.

GLASS

CLEANING MATERIALS TO USE:

- Glass cleaner
- Paper towels
- Baking soda

TO CLEAN

For everyday cleaning, use glass cleaner and a paper towel. For stubborn soil, use paste of baking soda and water. Rinse thoroughly.

REMOVABLE PARTS

SURFACE CONTROL KNOBS

CLEANING MATERIALS TO USE:

- Dishwashing detergent
- Warm water
- Soft cloth

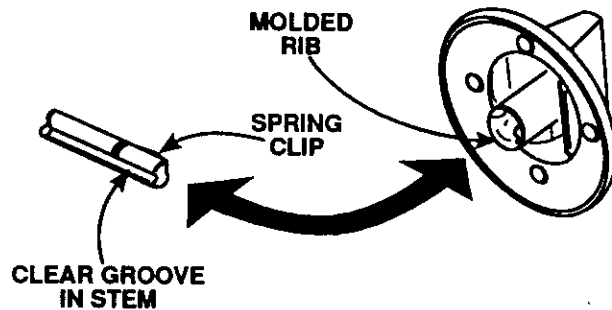

TO REMOVE:

1. Be sure the control knob is in the off position.
2. Pull straight off the stem.

Using a piece of string can make removing the knob easier. Slip the string under and around the knob, pulling straight out.

TO CLEAN:

Wash the knob thoroughly with soapy water. Dry completely with a soft cloth. **DO NOT let the knob soak.**

TO REPLACE:

1. Check the back of the knob. The molded rib of the knob is designed to fit perfectly onto the knob stem.
2. Align the the molded rib to the clear groove in the knob stem.
3. Push the knob back as far as it will go.

REPLACING THE OVEN LIGHT BULB



CAUTION: Be sure the oven light switch is in the off position. Do not touch a hot light bulb with wet hands or a wet cloth. Wait until the bulb has cooled and use a dry cloth. Never touch the live collar of the bulb. If you are replacing a broken light bulb, make sure the power supply is off.

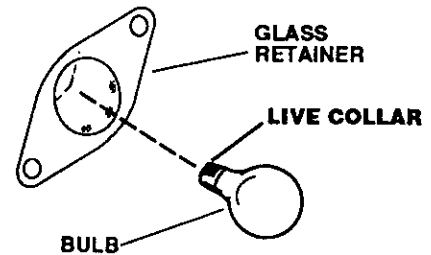

TO REPLACE:

1. Unscrew the light blub.
2. Replace the bulb with a 3 1/2" 40 watt appliance bulb.

REMOVABLE PARTS *continued*

REMOVABLE OVEN RACKS

CLEANING MATERIALS

- Dishwashing detergent
- Warm water
- Scouring pad or soap-filled steel wool pad

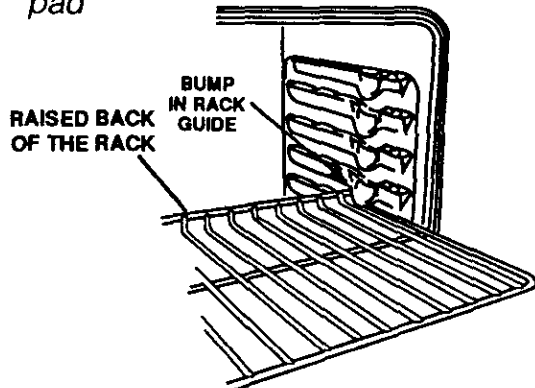

TO REMOVE:

1. Pull the racks out to the stop lock position.
2. Pull up the front of the rack and slide under the bump of the rack guide.

TO CLEAN:

Clean with warm water and detergent. For hard to remove stains, gently scrub with a scouring pad or a soap-filled steel wool pad. Rinse well.

TO REPLACE:

1. Place the raised back of the rack onto the rack guides.
2. Lift the front of the rack until the raised back slides under the bump of the rack guides.
3. Slide the rack all the way back.

REMOVABLE OVEN DOOR

BROIL STOP POSITION

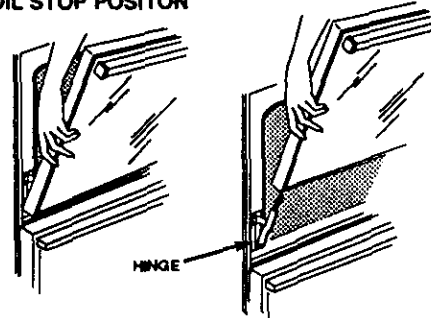

TO REMOVE:

1. Open the door to the broil stop position.
2. Grasp the door at each side and lift up and off the hinges. **DO NOT LIFT DOOR BY THE HANDLE.**



CAUTION: When the door is removed and the hinge arms are at the broil stop position. As a precaution, cover the hinge arms with toweling or an empty paper towel roll. Do not bump or try to move the hinge arms while working in the oven area. They could snap back causing injury to the hands or damage the porcelain finish of the front frame.

TO REPLACE:

1. Make sure the hinge arms are in the broil stop position.
2. Lift the door by the sides.
3. Line up the slots at the bottom edge of the door with the hinge arms.
4. Slide the door down onto the hinge arms as far as it will go.
5. Close the door.

REMOVABLE PARTS *continued*

REMOVABLE STORAGE DRAWER

CLEANING MATERIALS

- Dishwashing detergent
- Damp cloth
- Warm water

TO REMOVE:

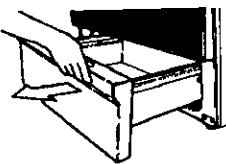

1. Pull the drawer out until it stops.

2. Lift the front of the drawer until the stop guide of the drawer clears the stop guide on the base rail.



3. Lift the drawer up and over the drawer stop.

TO CLEAN

Wipe the inside and outside with warm soapy water and a damp cloth or sponge. Do not use harsh abrasives or scouring pads on the drawer.

TO REPLACE

1. Lift the front of the drawer stop and lower the stop of the drawer through the opening of the base rail.
2. Lower the front of the drawer and push back the drawer until it stops.

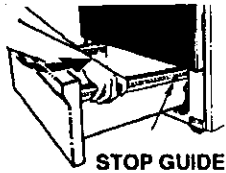

3. Lift up on the front of the drawer until the stop guide of the drawer clears the stop guide of the base rail. Slide the drawer into place.



CAUTION: The drawer gives you space for keeping cookware and bakeware.

Plastics and flammable materials should not be kept in this drawer. Do not overload the storage drawer. If the drawer is too heavy, it may slip off the base rail when opened.

LIFT UP COOKTOP

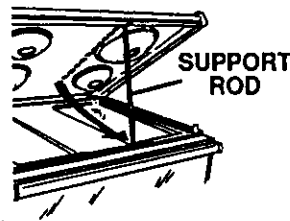

SUPPORT RODS

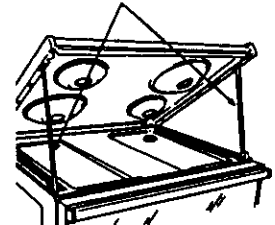

1. Grasp the edge of the cooktop and lift up.
2. Holding the cooktop with one hand, lift the support rod(s) up and rest the edge of the cooktop on it.
3. When cleaning is finished, lower the support rod(s) and the cooktop.



CAUTION: When working in this area, be careful not to bump into the support rod(s). The porcelain enamel surface of the cooktop can chip if dropped.

REMOVABLE PARTS *continued*

REMOVABLE COOKTOP UNIT

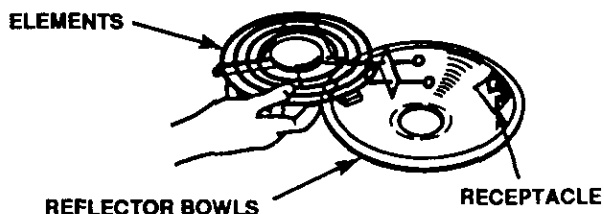

TO REMOVE:

1. Be sure the controls are in the off position and the elements are cool before attempting to remove them.
2. Grasp the element and lift slightly, just enough to clear the drip bowl and pull it straight out.



CAUTION: Do not lift the element more than 1". Lifting the element more than 1" can damage the receptacle, causing the element not to lie flat when it is plugged back in.

3. Lift out the drip bowl.

TO CLEAN THE DRIP BOWL:

For brown food stains — use dishwashing detergent, warm water, plastic scouring pads, mild abrasive cleaners, soap-filled scouring pads or ammonia.

Clean drip bowls after each use. Rinse and dry well. Foods that are not removed can cause permanent stains that cannot be removed. For heavily soiled bowls, place an ammonia-soaked paper towel over the bowl to loosen the soil, then gently scrub the bowl with a plastic scouring pad.

For blue-gold heat stains — use a metal polish.

These stains are caused by overheating, and are usually permanent. To help minimize this effect, avoid excessive use of high heat settings and use flat bottom pans that do not extend more than 1" from the edge of the cooking element.



CAUTION: Do not operate the cooktop elements without the drip bowl in place. Scorching of the cooktop, burning of wiring insulation and loss of energy will occur.

TO REPLACE THE UNIT:

1. Place the drip bowl into the opening and make sure the receptacle is visible.
2. Slide the element firmly back into the receptacle and lower it onto the drip bowl.

BEFORE CALLING FOR SERVICE

To save you time and money, before making a service call, check the list below for any problem you may feel you have with the performance of your range. If the problem is something you cannot repair, use the Consumer Service Numbers located at the back of this manual. **When making any calls, have the model number, repair parts list, use and care manual and the date of purchase available.**

PROBLEM	POSSIBLE CAUSE	POSSIBLE SOLUTION
Oven will not work; totally inoperative.	No power to range.	<ul style="list-style-type: none"> a. Check the household circuit breaker or fuse box. b. Check to make sure the range is plugged in.
Foods do not bake properly.	<ul style="list-style-type: none"> a. Oven is not preheated. b. Improper rack or pan placement. c. Oven vent blocked or covered. d. Improper use of foil. e. Improper temperature setting for utensil used. f. Recipe not followed. g. Improper oven control calibration. h. Range and oven rack not level. 	<ul style="list-style-type: none"> a. Be sure to preheat until the tone sounds. b. Maintain uniform air space around pans and utensils. See oven cooking section. c. Keep vent clear. d. Racks should not be covered during baking. e. Reduce temperature 25 degrees for glass or dull/darkened pans. f. Check recipe and measurement. g. Check the temperature adjustment following this section. h. Check the installation instructions for leveling.
Oven temperature seems inaccurate.	Oven control calibration.	See oven cooking section.
Oven light does not work.	<ul style="list-style-type: none"> a. Light switch is in off position. b. Bulb needs replacing. 	<ul style="list-style-type: none"> a. Check switch setting. b. Check or replace light bulb.

BEFORE CALLING FOR SERVICE *continued*

PROBLEM	POSSIBLE CAUSE	POSSIBLE SOLUTION
Foods do not broil properly.	<ul style="list-style-type: none">a. <i>Improper rack position.</i>b. <i>Oven preheated.</i>c. <i>Improper use of foil.</i>d. <i>Oven door closed during broiling.</i>e. <i>Low voltage (208 volts).</i>f. <i>Improper broiling time.</i>	<ul style="list-style-type: none">a. <i>Check broil pan placement; see broiling section.</i>b. <i>Do not preheat when broiling.</i>c. <i>Check broiling section.</i>d. <i>Open door to broil stop position.</i>e. <i>Use higher rack position and /or longer cooking time.</i>f. <i>Check broiling chart in broiling section.</i>
Oven smokes.	<ul style="list-style-type: none">a. <i>Dirty oven.</i>b. <i>Improper use of aluminum foil.</i>c. <i>Broiler pan containing grease left in the oven.</i>	<ul style="list-style-type: none">a. <i>Check for heavy spillover.</i>b. <i>Use of foil not recommended.</i>c. <i>Clean pan and grid after each use.</i>

“DO IT YOURSELF” TEMPERATURE ADJUSTMENT

You may feel that your new oven cooks differently than the oven it replaced. We recommend that you use your new oven a few weeks to become more familiar with it, following the times given in your recipes as a guide.

If you think your new oven is too hot (burning foods) or not hot enough (foods are undercooked) you can adjust the temperature yourself. The appearance and texture of foods is a better indicator of oven accuracy than an inexpensive thermometer, such as those found in grocery stores, to check the temperature setting of your new oven. These thermometers can vary by 20-40 degrees. In addition, the oven door must be opened to read these thermometers. Opening the door will change the temperature of the oven.

To decide how much to change the temperature, set the oven temperature 25 degrees higher (if foods are undercooked) or 25 degrees lower (if foods are burning) than the temperature in your recipe, then bake. The results of this “test” should give you an idea of how much the temperature should be changed.

TO MAKE THE ADJUSTMENT

1. Turn to OFF and remove the knob by pulling straight off.
2. Look at the back of the knob. The arrow pointing to the center of the bottom screw indicates the original factory setting.
3. Use a screwdriver to loosen the two screws about 2 turns each.
4. Hold the knob handle (A on illustration) while turning the disk (B on illustration) in the desired direction to increase or decrease the temperature. (See illustration below for “Standard Thermostat.”) As you turn, you should be able to hear clicks and feel notches or teeth. Each click or notch is 15°F. You can turn up to 2 clicks or notches in either direction.
5. When you reach the desired adjustment, retighten both screws. Return the knob to the range.

(See illustration below—use the arrows in the gray area to make your temperature adjustment.)

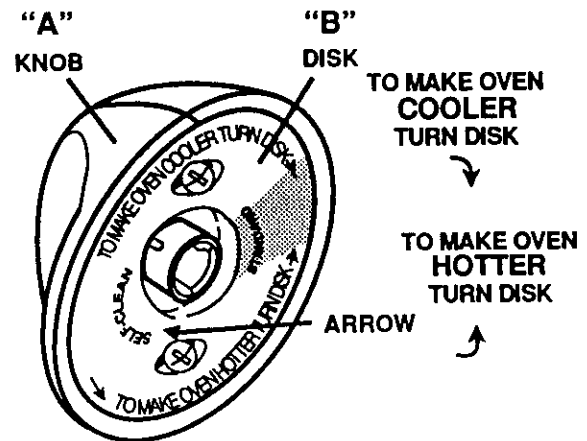

For the repair or replacement parts you need
delivered directly to your home

Call 7 am - 7 pm, 7 days a week

1-800-366-PART

(1-800-366-7278)

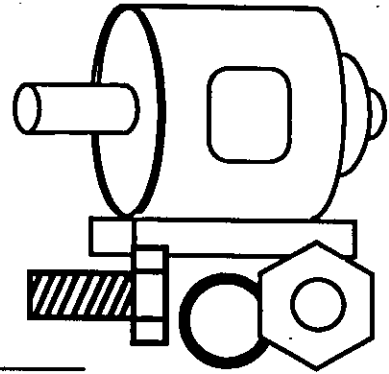

For in-home major brand repair service

Call 24 hours a day, 7 days a week

1-800-4-REPAIR

(1-800-473-7247)

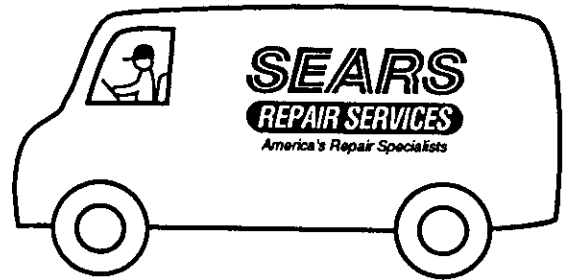

For the location of a
Sears parts and Repair Center in your area

Call 24 hours a day, 7 days a week

1-800-488-1222



For information on purchasing a Sears
Maintenance Agreement or to inquire
about an existing Agreement

Call 9 am - 5 pm, Monday-Saturday

1-800-827-6655



SEARS
REPAIR SERVICES

America's Repair Specialists

KENMORE ELECTRIC RANGE WARRANTY

Dear Customer:
Our constant efforts are directed toward making sure your new Kenmore Range will arrive at your home in perfect condition and will give you proper performance. As part of these efforts, we feel it is our responsibility to provide you with this warranty for your range.



FULL ONE YEAR WARRANTY ON THE FUNCTIONING OF ALL PARTS EXCEPT GLASS PARTS

If, within one year from the date of installation, any part, other than a glass part, fails to function properly due to a defect in material or workmanship, Sears will repair or replace it, free of charge.

FULL 30-DAY WARRANTY ON GLASS PARTS AND FINISH OF PORCELAIN ENAMEL, PAINTED OR BRIGHT METAL FINISHED PARTS

If, within 30 days from the date of installation, any glass part or the finish on any porcelain enamel, painted or bright metal part is defective in material or workmanship, Sears will replace the part, free of charge.

FULL 90-DAY WARRANTY ON MECHANICAL ADJUSTMENTS

For 90 days from the date of installation, Sears will provide, free of charge, any mechanical adjustments necessary for proper operation of the range, except for normal maintenance.

If the range is subjected to other than private family use, the above warranty coverage is effective for only 90 days.

WARRANTY SERVICE IS AVAILABLE BY CONTACTING THE NEAREST SEARS SERVICE CENTER/DEPARTMENT IN THE UNITED STATES

This warranty applies only while this product is in use in the United States. This warranty gives you specific legal rights, and you may also have other rights which vary from state to state.

SEARS, ROEBUCK and CO.
Dept. 817 WA
Hoffman Estates, IL 60179

WE SERVICE WHAT WE SELL

"We Service What We Sell" is our assurance to you that you can depend on Sears for service because Sears service is nationwide.

Your Kenmore Range has added value when you consider that Sears has a service unit near you staffed by Sears trained technicians. . . professional technicians specifically trained on Sears appliances, having the parts, tools and equipment to ensure that we meet our pledge to you — "We Service What We Sell!"

TO FURTHER ADD TO THE VALUE OF YOUR RANGE, BUY A SEARS MAINTENANCE AGREEMENT.

Kenmore Ranges are designed, manufactured and tested for years of dependable operation. Yet, any modern appliance may require service from time to time. The Sears Warranty plus the Sears Maintenance Agreement provides protection from unexpected repair bills and assures you of enjoying maximum range efficiency.

Here's a comparative warranty and Maintenance Agreement chart showing you the benefits of a Sears Range Maintenance Agreement.

Years of Ownership Coverage		1st Year	2nd Year	3rd Year
1	Replacement of Defective Parts other than Porcelain or Glass	W	MA	MA
2	Mechanical Adjustment	90 DAYS W	MA	MA
3	Porcelain and Glass Parts	30 DAYS W	MA	MA
4	Annual Preventive Maintenance Check at your request	MA	MA	MA

W - Warranty MA - Maintenance Agreement

CONTACT YOUR SEARS SALESPERSON OR LOCAL SEARS SERVICE CENTER TODAY AND PURCHASE A SEARS MAINTENANCE AGREEMENT.

Kenmore® America's Best Selling Appliance Brand

Sold by SEARS, ROEBUCK AND CO., Hoffman Estates, IL 60179