



Project \_\_\_\_\_

Item No. \_\_\_\_\_

Quantity \_\_\_\_\_

### 36" Heavy Duty Sectional Range with Combination Tops

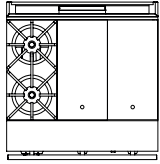

**B36-BHH**

Two 35,000 BTU open top burners and 24" hot top

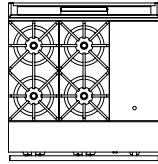

**B36-BBH**

Four 35,000 BTU open top burners and 12" hot top

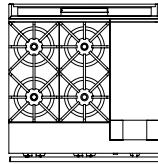

**B36-BBG**

Four 35,000 BTU open top burners and 12" griddle

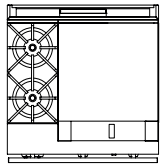

**B36-BGG/BTT**

Two 35,000 BTU open top burners and 24" standard or thermostatic griddle

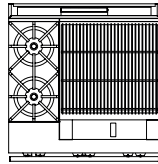

**B36-BCC**

Two 35,000 BTU open top burners and 24" charbroiler

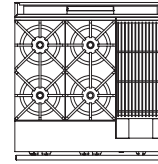

**B36-BBC**

Four 35,000 BTU open top burners and 12" charbroiler

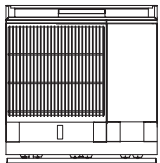

**B36-CCG**

24" charbroiler and 12" griddle

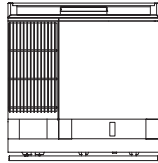

**B36-CGG/BTT**

12" charbroiler and 24" standard or thermostatic griddle

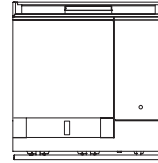

**B36-TTH**

24" thermostatic griddle and 12" hot top

*These models may be configured as mirror images of those shown here. Additional configurations available, contact factory for details.*

The Blodgett 36" wide sectional range is available with a choice of base

- Model B36A- (Convection Oven Base)
- Model B36D- (Standard Oven Base)
- Model B36C- (Cabinet Base)
- Model B36N- (Modular Range-Top)

Three flue-riser heights are available, and the flue riser can support up to 250 pounds (for an optional shelf, salamander-broiler, or cheese melter). An optional rearward-extending flue riser is available to increase the overall depth to match a deep battery. Battery-design assistance is available!

#### STANDARD FEATURES (All models)

- 5" flue riser
- 7" stainless-steel front rail with "belly bar"
- Standard range depth
- Battery end-units have solid side (no manifold cover plate)
- Stainless-steel front and sides
- Fully insulated lining and burner boxes
- 6" adjustable legs (except on modular range-top model)
- Warranty: two year parts and labor from date of purchase

#### Open Top Burner Features

- Two open-top 35,000 BTU burners per 12" section with separate controls
- Removable welded grates

#### Hot Top Features

- 32,000 BTU per 12" section with separate controls
- Cast iron surface with surface temperature up to 700°F

#### Charbroiler Features

- 32,000 BTU per 12" section with separate controls
- Cast iron grates with surface temperature of up to 725°F

#### Griddle Features

- 32,000 BTU per 12" section with separate controls
- 1" thick steel surface with side splashes
- Grease drawer holds 3/4 gallon

#### STANDARD FEATURES (Convection & Standard Ovens)

- 45,000 BTU oven with standing pilot (optional electronic ignition available)
- Cool-to-the-touch oven handle
- Recessed oven control panel for added reliability
- Standard-oven interior is 14" high, 26" wide, 26.5" deep (so sheet pans fit either way)
- Two oven racks (2-1/4" between each of five positions)
- "Insta-On" thermostat with a wide range of 150°F to 550°F
- Convection-oven models have 1/3 hp, two-speed blower
- Porcelain enamel oven interior

#### STANDARD FEATURES (Base Cabinets)

- Dual side-by-side stainless-steel doors

#### OPTIONS AND ACCESSORIES

(AT ADDITIONAL CHARGE)

- Flue riser
  - 24"
  - 36"
- Single-shelf (mounts on 24" flue riser)
  - Solid shelf
  - Tubed shelf
- Double-shelf (mounts on 36" flue riser)
  - Solid shelves
  - Tubed shelves
- Stainless-steel back
- Deep range depth
- Additional oven racks
- Bolt down flange feet
- Casters (in lieu of legs)
- Open frame base with casters
- Cable restraint kit for units on casters



**BLODGETT**

www.blodgett.com

1100 Old Honeycutt Road Fuquay-Varina, NC 27526 USA

Phone: (877) 255-3976 • Fax: (866) 644-1354



# 36" COMBINATION TOPS

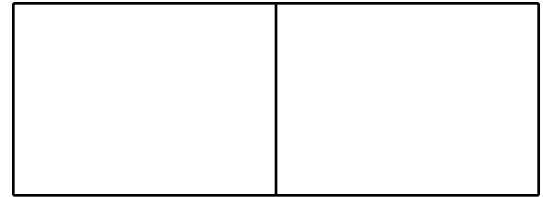

## APPROVAL/STAMP

Model	Width	Height	Depth	Volume	Weight
B36A	45.5 (1156)	45.0 (1143)	55.0 (1397)	65.2 cu ft (1.85 cu m)	740 lbs (336 kg)
B36D	44.0 (1118)	43.0 (1092)	45.5 (1156)	49.8 cu ft (1.41 cu m)	690 lbs (313 kg)
B36C	44.0 (1118)	43.0 (1092)	45.5 (1156)	49.8 cu ft (1.41 cu m)	490 lbs (222 kg)
B36N	44.0 (1118)	22.0 (559)	45.5 (1156)	25.5 cu ft (0.72 cu m)	450 lbs (204 kg)

Add 90 lbs (40.8kg) to B36A-BGG/BTT, B36A-GGC/TTC models  
 Add 90 lbs (40.8kg) to B36D-BGG/BTT, B36D-GGC/TTC models  
 Add 50 lbs (22.6kg) to B36C-BGG/BTT, B36C-GGC/TTC models  
 Add 90 lbs (40.8kg) to B36N-BGG/BTT, B36N-GGC/TTC models

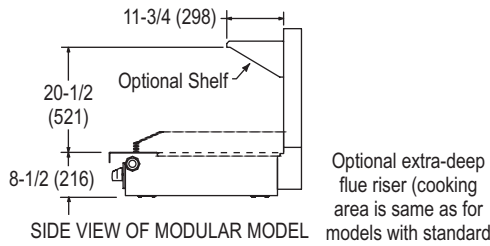
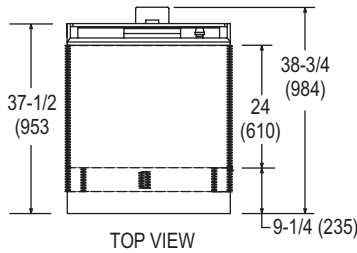

Optional extra-deep flue riser (cooking area is same as for models with standard flue riser)

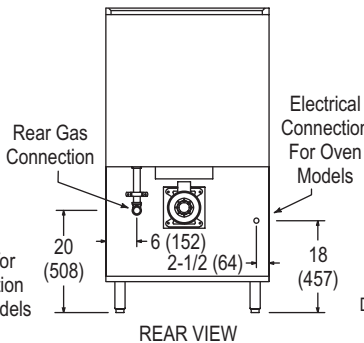
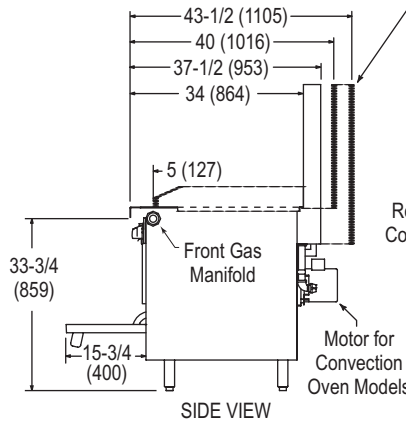
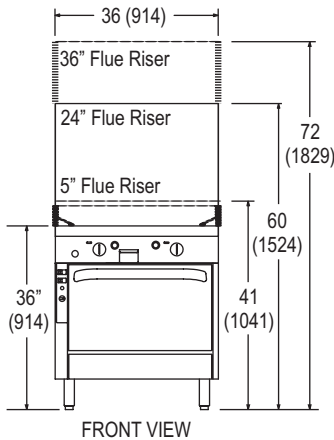

Dimensions are in inches and (millimeters)

### SHORT FORM SPECIFICATIONS

The item shall be a 36"-wide front-manifold sectional range. The item shall have a 7" front rail and a belly bar. The item shall have 6" adjustable legs [casters]. The item shall have a [5" 24" 36"] flue riser able to support 250 pounds. The exterior (except for the back) shall be constructed of 430 stainless steel #3 polish. If the item is at the end of a battery, the end side shall be solid (rather than have a coverplate over the end of the front manifold).

Model 36A: The item shall have a 45,000 BTU convection oven with standing pilot and a thermostat range of 150°F to 550°F (66°C to 288°C). The oven interior shall be porcelain, measure 14" high x 26" wide x 24" deep, and have two racks with five-position side-rails with 2-1/4" between positions. The blower fan shall have two speeds and a 1/3 hp motor.

Model 36D: The item shall have a 45,000 BTU standard oven with standing pilot and a thermostat range of 150°F to 550°F (66°C to 288°C). The oven interior shall be porcelain, measure 14" high x 26" wide x 26.5" deep, and have two racks with five-position side-rails with 2-1/4" between positions.

Model 36C: The item shall have a cabinet base with two side-by-side stainless steel doors.

### UTILITY INFORMATION

Model	Open Top Nat (LP)	Hot Top Nat (LP)	Griddle Nat (LP)	Charbroiler Nat (LP)	Total Nat (LP)
B36-BHH	70K (60K)	64K (56K)	-	-	134K (116K)
B36-BBH	140K (120K)	32K (28K)	-	-	172K (148K)
B36-BBG	140K (120K)	-	32K (28K)	-	172K (148K)
B36-BGG/TT	70K (60K)	-	64K (56K)	-	134K (116K)
B36-BCC	70K (60K)	-	-	64K (56K)	134K (116K)
B36-BBC	140K (120K)	-	-	32K (28K)	172K (148K)
B36-CCG	-	-	32K (28K)	64K (56K)	96K (84K)
B36-CCG/TT	-	-	64K (56K)	32K (28K)	96K (84K)
B36-TTH	-	32K (28K)	64K (56K)	-	96K (84K)

For units with either a convection or standard oven base add 45K (42K) to BTU totals.

Blodgett can often accommodate special or custom requirements. Contact your Blodgett representative.

**NOTE:** The company reserves the right to make substitutions of components without prior notice

**GAS:** Each unit has a 1-1/4" front gas manifold that couples to the adjacent sectional unit(s), and can be ordered with a 1" rear gas connection with a male NPT connector. Minimum supply pressure is 7" W.C. for natural gas, 11" W.C. for propane. An external pressure regulator and shut off valve must be provided. If using a flexible-hose gas connection, the I.D. of the hose must not be smaller than the connector on the unit and must comply with ANSI Z21.69. Provide an adequate means of restraint to prevent undue strain on the gas connection.

**ELECTRICITY:** Both standard-oven and convection-oven models require electric power (50Hz or 60Hz single-phase AC). 120V models have a 7-foot (2134 mm) power cord with a grounded plug. 208/240V models have a terminal block for connection to a single-phase 208/240V source.

**FLUE EXHAUST:** Installation under a vented hood is recommended.

### SPECIFY

- Gas Type  Natural Gas  Propane
- Manifold  Front (1-1/4")  Rear (1")
- Flue Riser Height  5"  24" (option)  36" (option)
- Range Depth  Standard  Deep (option)
- Position in Battery  Left End  Right End  Not at End
- Electric Power (ovens)  120V  208/240V
- Operating altitude (if above 2000 ft (700 meters) \_\_\_\_\_

## BLODGETT

www.blodgett.com

1100 Old Honeycutt Road Fuquay-Varina, NC 27526 USA • Phone: (877) 255-3976 • Fax: (866) 644-1354