

RICCAR®

BRILLIANCE 

BRLP, BRLD & BRLS

Owner's Manual



IMPORTANT SAFETY INSTRUCTIONS 2

- Polarization instructions 3
- Description of the vacuum 4
- Before using your Brilliance the first time 6

Operation

- Unwinding the power cord 7
- Vacuuming carpet 8
- Vacuuming hard surfaces 8
- Carpet height adjustment 9
- Vacuuming under furniture 10
- Carrying the vacuum 11

Attachment Cleaning

- Wand cleaning 12
- Cleaning tools 13
- Adjusting the suction power 15
- Optional premium attachment kit 16
- Hose disconnect 16

Maintenance and Care

- When to change the vacuum bag 18
- Replacing the vacuum bag 19
- When to change the filters 20
- Replacing the filters 20
- Lifetime belt warranty 22
- Annual checkup reminder 22

Problem Solving Guide

- Full bag or clog indicator light 23
- Jammed brushroll 23
- Thermal motor protection 24
- Trouble shooting 25
- How to contact your Authorized Retailer 25
- Visit Riccar on-line 25

Warranty 26

IMPORTANT SAFETY INSTRUCTIONS

When using an electrical appliance, basic precautions should always be followed, including the following:

READ ALL INSTRUCTIONS BEFORE USING THIS APPLIANCE

WARNING: The manufacturer cannot accept responsibility for damage caused when the appliance is not used according to the instructions, or for uses other than those for which it was intended.

To reduce the risk of fire, electric shock or injury:

- Do not leave appliance when plugged in. Unplug from outlet when not in use and before servicing.
- Do not handle plug or appliance with wet hands.
- Do not put any object into openings. Do not use with any opening blocked; keep free of dust, lint, hair and anything that may reduce air flow.
- Do not allow to be used as a toy. Close attention is necessary when used by or near children.
- Keep hair, loose clothing, fingers and all parts of body away from openings and moving parts.
- Use only as described in this manual. Use only manufacturer's recommended attachments.
- Do not pick up anything that is burning or smoking, such as cigarettes, matches or hot ashes.
- Do not use with damaged cord or plug. If appliance is not working as it should, has been dropped, damaged, left outdoors, or dropped into water, return it to your Authorized Retailer for service.
- Do not use without vacuum bag and/or filters in place.
- Turn off all controls before unplugging.
- Use extra care when cleaning on stairs.
- Do not pull or carry by cord, use cord as a handle, close a door on the cord, or pull cord around sharp edges or corners. Do not run appliance over cord. Keep cord away from heated surfaces.
- Do not use to pick up flammable or combustible liquids such as gasoline or use in areas where they may be present.
- Do not attempt to service the unit while appliance is plugged in.
- Do not unplug by pulling on cord. To unplug, grasp the plug, not the cord.

SAVE THESE INSTRUCTIONS.

Polarization Instructions

POWER CORD, 2-WIRE POLARIZED CORD

Household models BRLS, BRLD and BRLP

To reduce the risk of electric shock, this product is equipped with a polarized alternating current line plug (a plug having one blade wider than the other). This plug will fit into the power outlet only one way. This is a safety feature. If you are unable to insert the plug fully into the outlet, try reversing the plug. If the plug should still fail to fit, contact a qualified electrician to replace the obsolete outlet. Do not defeat the safety purpose of the polarized plug.

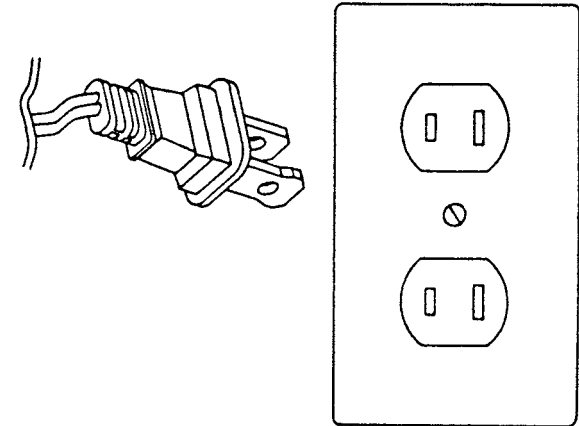

Description of the vacuum

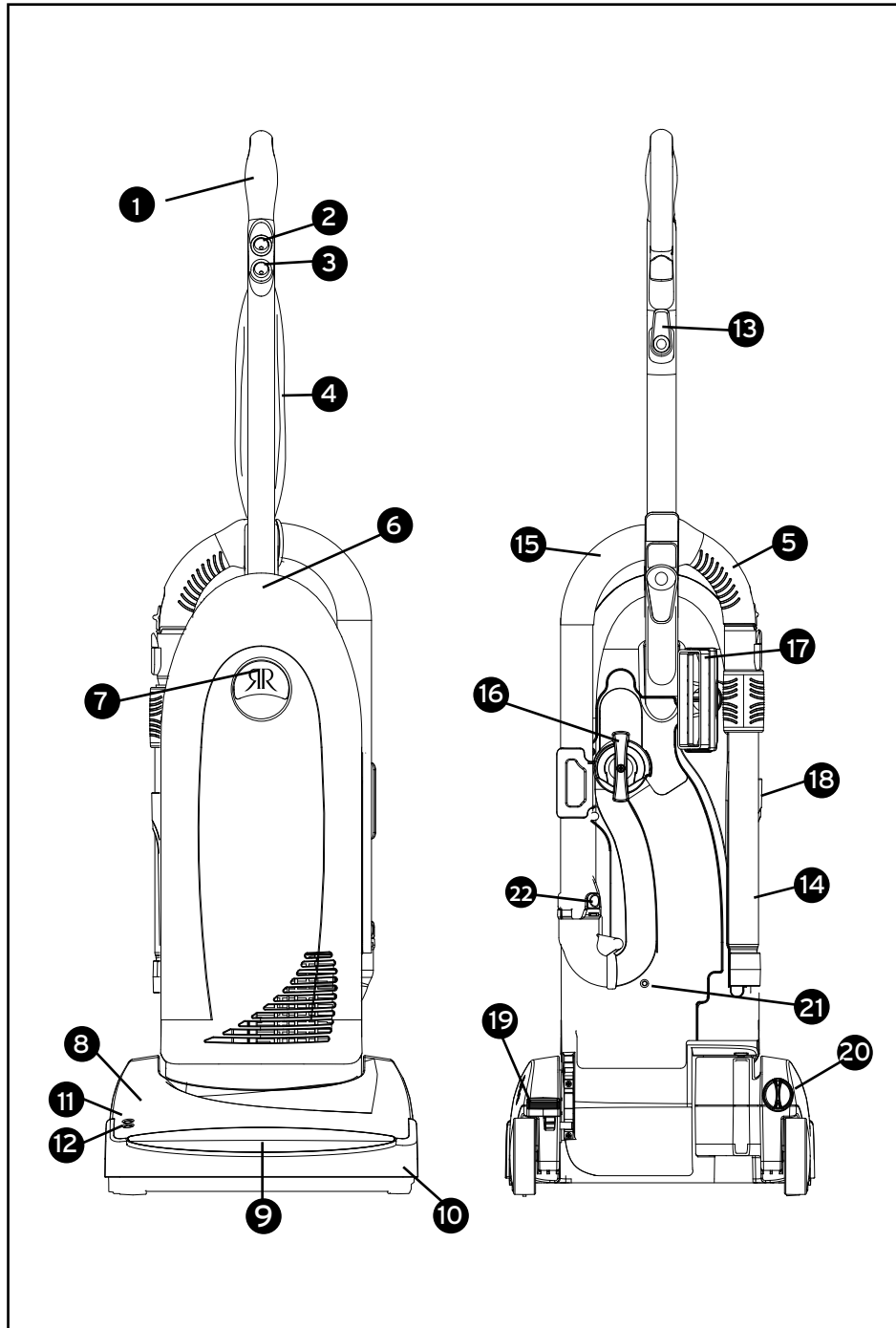

Description of the vacuum

- 1 Ergonomic handle
- 2 Main on / off power switch
- 3 Carpet / bare floor switch
- 4 Power cord
- 5 Fast Task™ tools (for models BRLP & BRLD)
- 6 Carrying handle (located behind bag compartment lid)
- 7 Bag compartment latch (to replace vacuum bag)
- 8 Vacuum nozzle
- 9 Xenon headlight
- 10 Furniture guard
- 11 Brushroll jam indicator
- 12 Full bag / clog indicator
- 13 Quick release cord hook
- 14 Telescopic wand (for models BRLP & BRLD)
- 15 5-to-1 stretch hose (for models BRLP & BRLD)
- 16 Tool activation dial (for models BRLP & BRLD)
- 17 Combination dusting / upholstery brush (for models BRLP & BRLD))
- 18 Crevice tool (for models BRLP & BRLD)
- 19 Handle release pedal
- 20 Carpet height adjustment dial
- 21 Thermal reset button
- 22 Hose disconnect (for models BRLP & BRLD)

Attaching the handle to the vacuum

- Remove the handle screw located on the back of the vacuum. Insert the handle downward into the body of the vacuum. Insert screw and tighten.
- Open bag compartment lid to ensure vacuum bag is in place.
- Your vacuum is now ready for use.

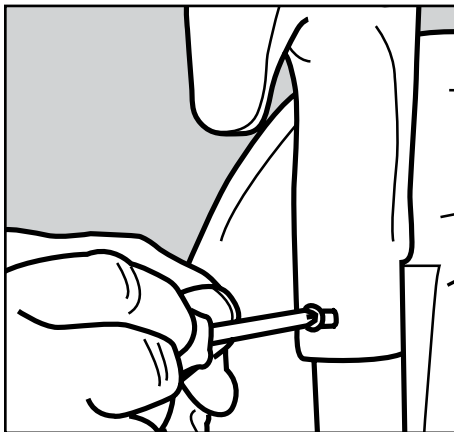
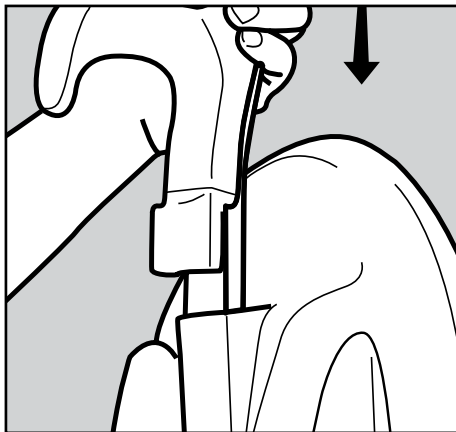
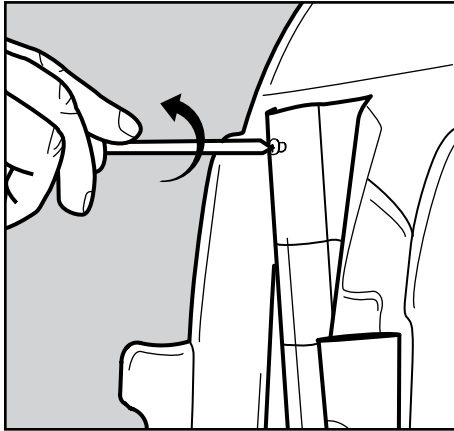

Unwinding the power cord

- The upper cord hook rotates to allow for quick access to the power cord.

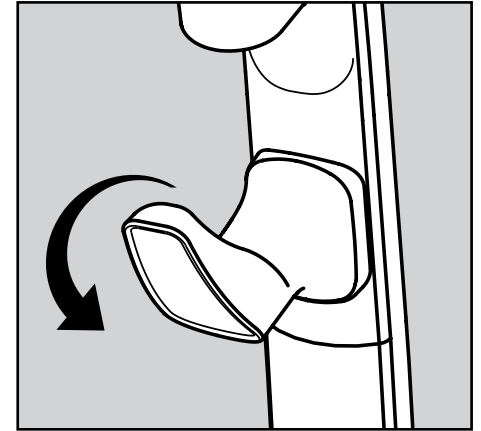

Vacuuming carpet

- For carpet cleaning, press the “on / off” switch on and press the “carpet” switch on. Both lights should be lit.

Vacuuming hard surfaces

- For bare floor cleaning (i.e. tile, wood, or linoleum), turn the main “on / off” button on and the “carpet” switch to floor. Only the “on / off” button light should be on.

Brushroll auto shut-off feature

Note: When the Brilliance is turned on and in the upright position, the brushroll will not spin as to eliminate the possibility of damage to floor surfaces. The brushroll will spin when the handle is lowered, provided the “carpet” switch is on.

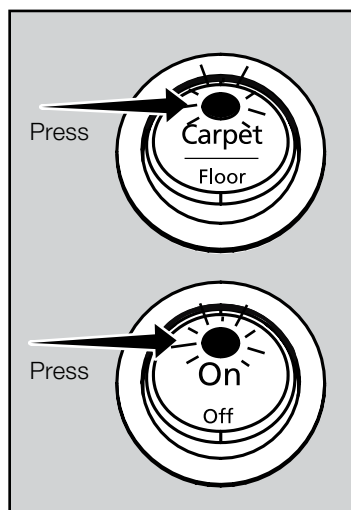

Carpet Cleaning

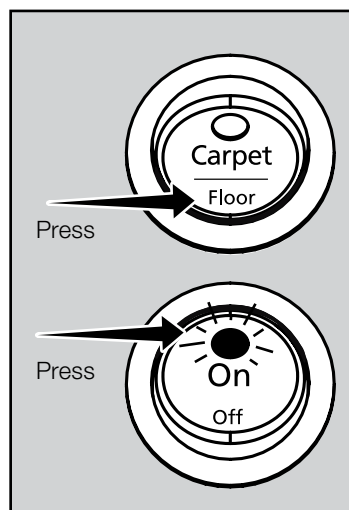

Bare Floor Cleaning
(Wood, Tile, etc.)

Carpet height adjustment

There are various carpet height settings available designed for numerous flooring surfaces.

- Locate the height adjustment dial just above the right rear wheel, and rotate the dial to the desired height.

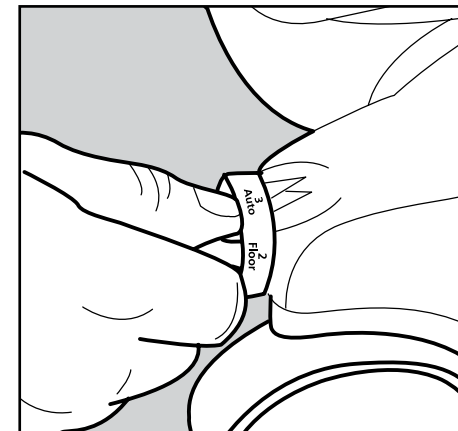

Model BRLP

- X Hi** Plush carpets
- High** Medium pile carpet
- Auto** General setting
- Floor** Hard floors
- X Low** Low pile carpet

Model BRLD and BRLS

- High** Medium pile carpet
- Auto** General setting
- Floor** Hard floors
- Low** Low pile carpet

- If it becomes difficult to push the vacuum across the carpet, adjust the dial to a higher carpet setting.

Vacuuming under furniture

Your Riccar Brilliance will lay flat on the floor for effective cleaning under beds and tables.

- Press the foot pedal release once for normal vacuum cleaning.
- Press the foot pedal release a second time to enable the vacuum to lay flat on the floor.

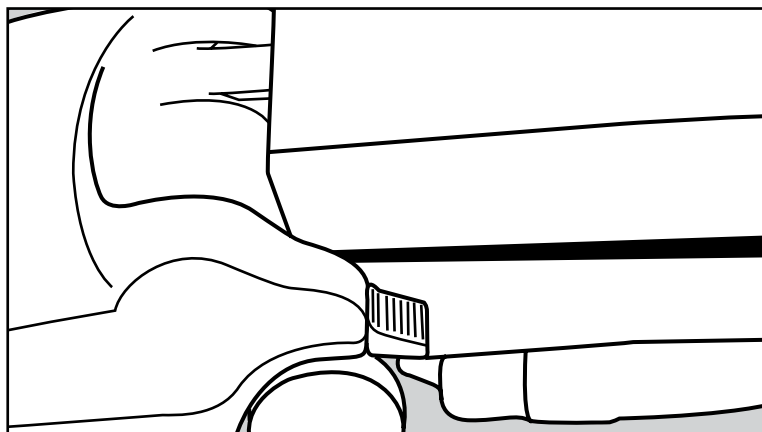
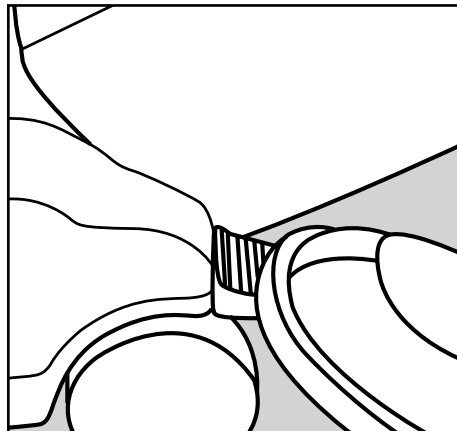
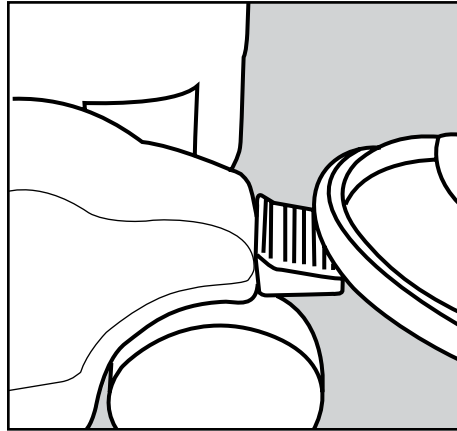

Carrying the vacuum

To safely transport your vacuum, especially when carrying the vacuum up and down stairs, use the ergonomic carry handle.

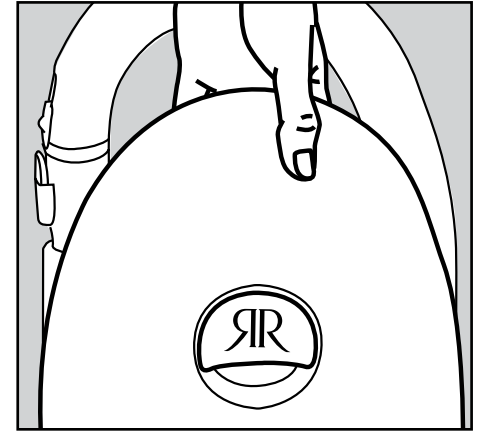

Wand cleaning (on models BRLP & BRLD)

With the on-board cleaning tools and vacuum wand, your Riccar Brilliance becomes a comprehensive cleaning system. Included with the BRLP and BRLD models is an upholstery tool, dusting brush, crevice tool, extension wand and a 5-to-1 stretch hose.

- To use the cleaning tools, lift the wand straight up from the vacuum. Turn the tool activation dial to the “on” position. The cleaning wand is now activated for quick cleaning.
- Extend the wand by grasping the wand release and pushing outward.
- Attach any of the on-board tools to the end of the cleaning wand.
- When finished with tool / wand cleaning, turn the tool activation dial to the “off” position. Insert the wand back into the vacuum and secure the wand by pushing the curved handle into the holder.

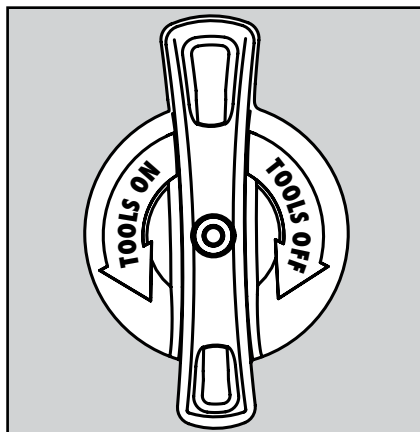
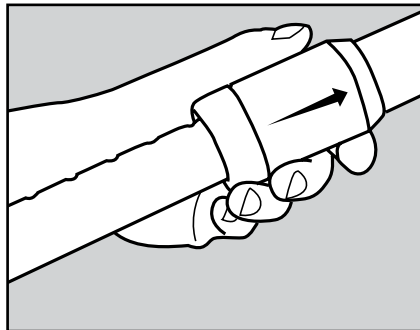
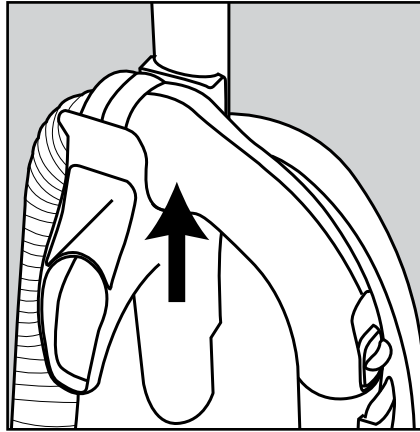

Cleaning tools (on models BRLP & BRLD)

Your vacuum is equipped with a dusting brush, upholstery brush and crevice tool. Other tools are available at your Authorized Riccar Retailer.

- Remove the cleaning wand from the vacuum and turn the tool activation dial to the “on” position. (See page 12)
- Insert any of the tools onto the end of the wand.

Dusting brush:

Ideal for table tops, shelves, blinds or hard surface floors.

Upholstery tool:

Ideal for soft surfaces like chairs and couches. Remove the dusting brush clip for upholstery cleaning.

Crevice tool:

Ideal for tight places like between seat cushions or corners.

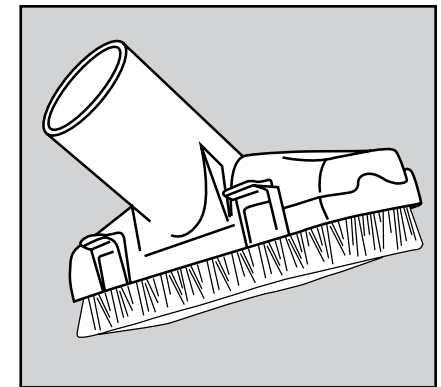
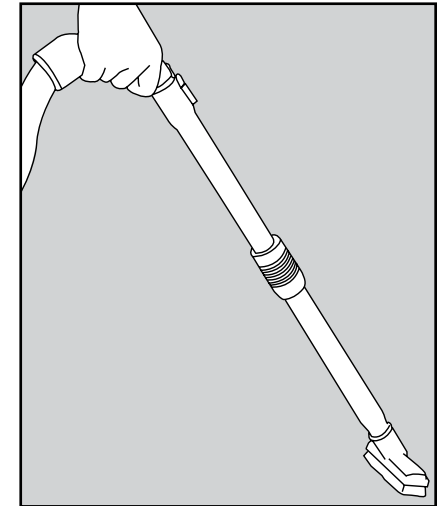

Dusting Tool

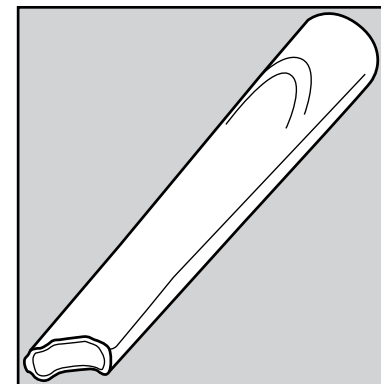

Crevice Tool

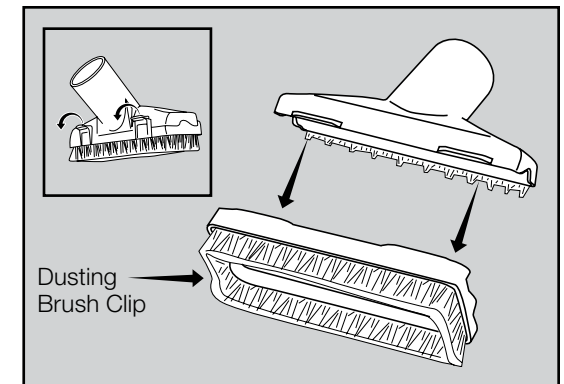

Upholstery Brush

Cleaning tools continued...

Cleaning tools can also be attached to the curved handle for above-floor cleaning.

- Disconnect the wand from the curved handle by pressing the release button.
- Attach any of the cleaning tools directly to the curved handle.

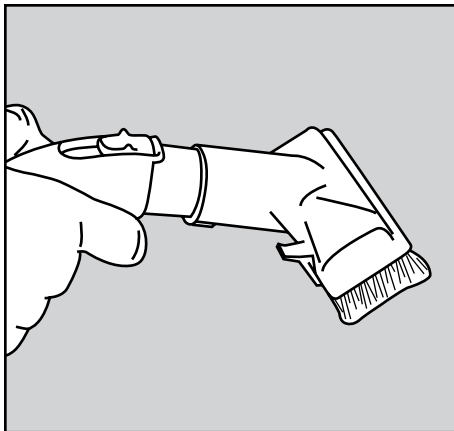
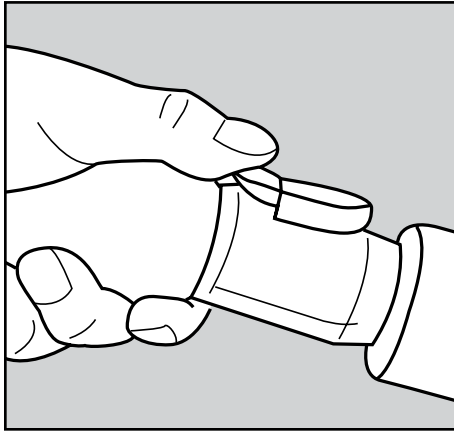

Adjusting the suction power for tool cleaning

Full suction power might be too strong for some cleaning situations. For example, reduced suction power would be appropriate for cleaning sheer curtains.

- On the curved handle, locate the suction relief valve and slide it backward. This reduces the suction power coming through the tool. Slide the valve forward when finished to restore full suction power.

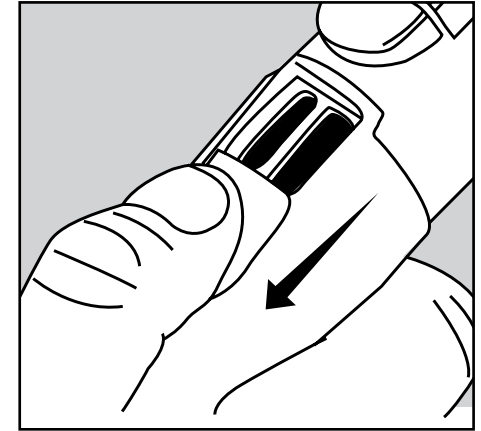

Attachment Cleaning

Optional premium attachment kit

A premium attachment kit is available through your Authorized Retailer. With numerous high quality accessories for your Brilliance, the kit is a safe and effective way to clean your stairs and a variety of other surfaces.

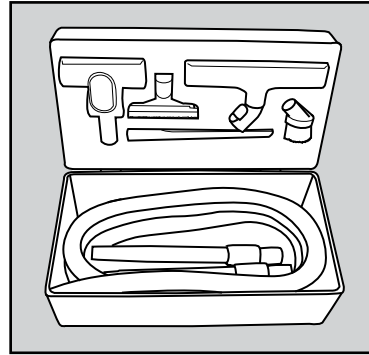

- Remember to activate tool use, you must turn the tool activation dial to the “on” position.

Disconnecting the hose for attachment cleaning.

To attach the longer hose from the premium attachment kit, disconnect the hose from the back of the vacuum by pressing the two buttons on the sides of the hose cuff. Then plug the longer hose into this port.

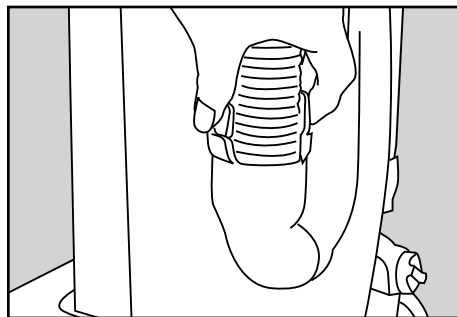

When to change the vacuum bag

The full bag indicator light is designed to show when the bag is full or when there is a clog in the vacuum.

The system measures airflow and alerts the user when airflow is significantly reduced—most commonly from full bags and clogs.

The light could also come on when vacuuming fine powders such as flour or drywall dust. These materials can quickly block the bag pores, significantly reducing airflow before the bag appears to be full. The vacuum bag should still be changed.

Note: The vacuum bags are disposable and intended to only be used once. Do not attempt to reuse as suction and filtration performance would be greatly reduced.

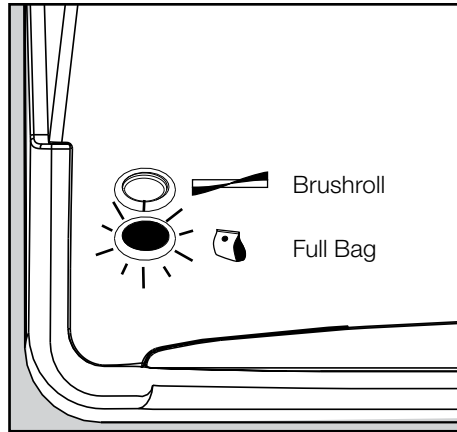

Yellow Warning Light

Replacing the vacuum bag

- Open the bag compartment lid.
- Remove vacuum bag by pressing the bag tab.
- To insert a new bag, place the base of the bag collar on the bag supports. Then secure the top of the bag collar with the bag tab.
- Tuck the bag corners into the vacuum before replacing the bag compartment lid.
- Replace lid and press onto vacuum until it snaps into place.

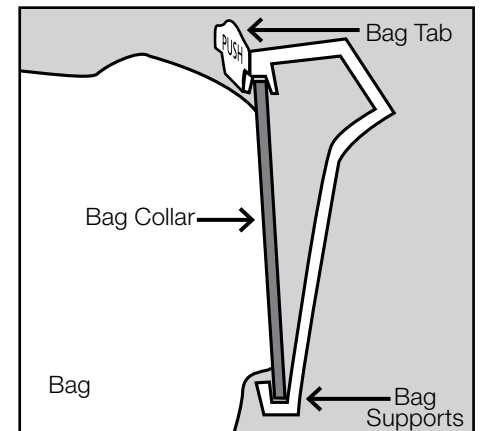
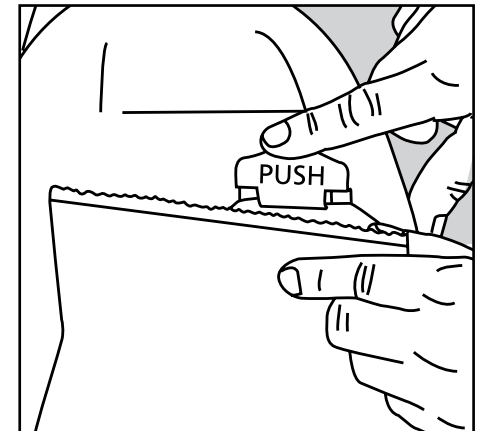
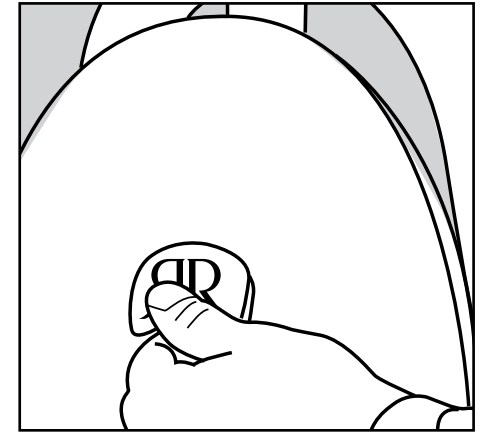

When to change filters

At minimum, it's recommended to replace the filters after using twelve vacuum bags.

If someone in your household is highly sensitive to airborne allergens, it is recommended to change the filter set after every six vacuum bags.

Replacing the post filter

Note: Your vacuum is equipped with either an S-Class HEPA filter or an electrostatic filter. To change either type of filter, follow the instructions below.

- Open the bag compartment lid and locate the post filter below the bag.
- Using the tab on the left, remove the used filter and throw away. **NOTE:** Filters cannot be washed and reused.
- When inserting the new post filter, first position the tabs in the right side of the casing. Then, snap it into place.
- Close the bag compartment lid.

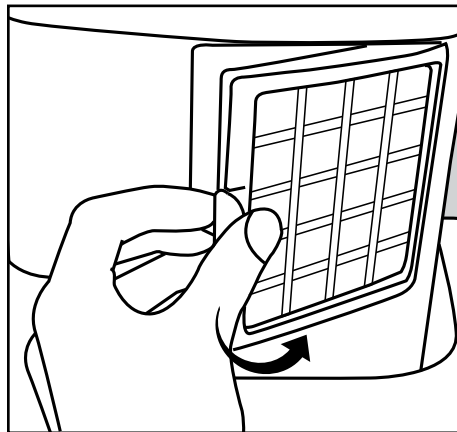
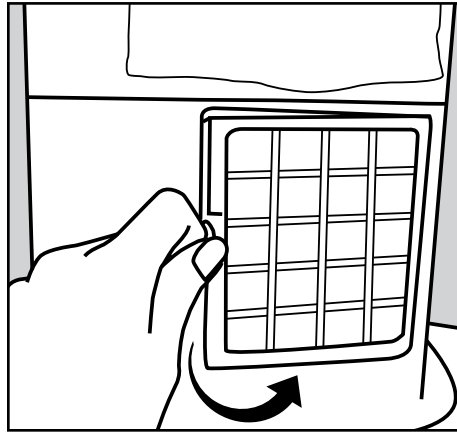

Replacing the secondary filter

- Open the bag compartment lid and locate the secondary filter on the left side of the bag compartment.
- Pull the front tab away from the vacuum to remove the filter holder.
- Remove and throw away the used filter.
- Insert the new filter. Then reposition the filter holder back end first and snap into place behind the tab.
- Close the bag compartment lid.

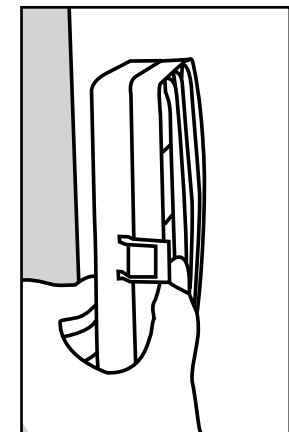
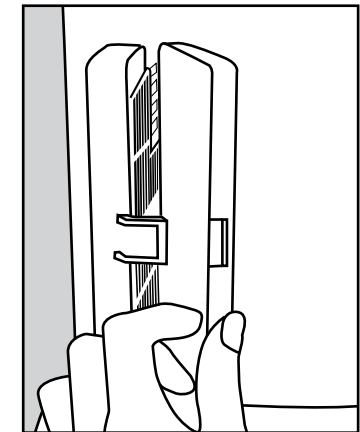
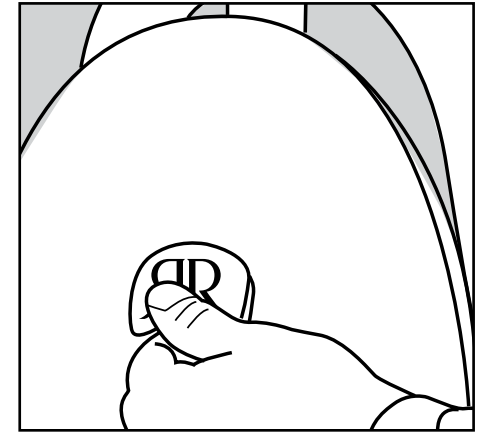

Replacing the direct air motor filter

- Press the handle release pedal with your foot, and tilt the handle back until it stops. Press the pedal again to lower the handle to the floor.
- Pull the black filter cover latch to access the filter.
- Remove and discard the used filter.
- Insert new direct air motor filter and snap the filter cover back into place.
- Return vacuum handle to its upright position.

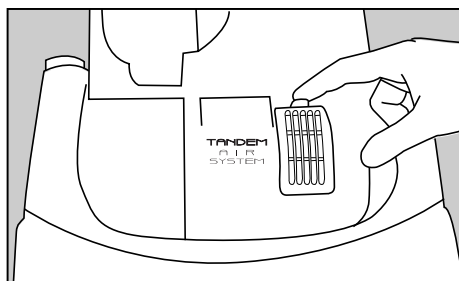
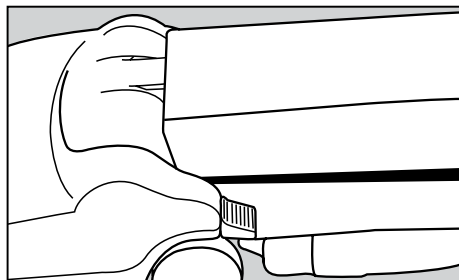

Lifetime belt protection warranty

Your vacuum belt is covered with a lifetime warranty. Should the vacuum belt break, simply bring your vacuum or the broken belt to your Authorized Riccar Retailer for a free replacement.

Annual checkup reminder

To keep your vacuum in peak operating condition, it is recommended you bring your vacuum to your Authorized Riccar Retailer for an annual checkup. Your Retailer will conduct a comprehensive examination to ensure your vacuum is in top operating condition.

Full bag or clog indicator light

The full bag indicator light is designed to show when the bag is full or when there is a clog in the vacuum.

The system measures airflow and alerts the user when airflow is significantly reduced—most commonly from full bags and clogs.

The light could also come on when vacuuming fine powders such as flour or drywall dust. These materials can quickly block the bag pores, significantly reducing airflow before the bag appears to be full. The vacuum bag should still be changed.

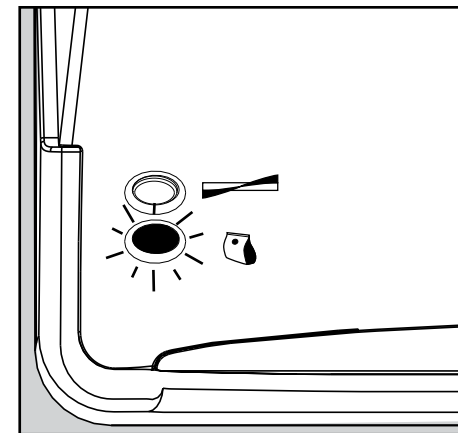

Yellow Warning Light

Jammed brushroll

If an object, such as a throw rug or article of clothing is ever picked up into your vacuum, the vacuum will sense this “jammed brushroll” condition and turn off the brushroll. When this happens, the “brushroll warning” light on the top of the nozzle will light up in red.

- Turn off the vacuum and remove the cause of the jam. Turn vacuum back on. If the brushroll is free of any object and the “brushroll warning” light is still lit, it’s likely the clogged condition is located in the vacuum motor fan. If so, please take your Brilliance to a Authorized Riccar Retailer for service.

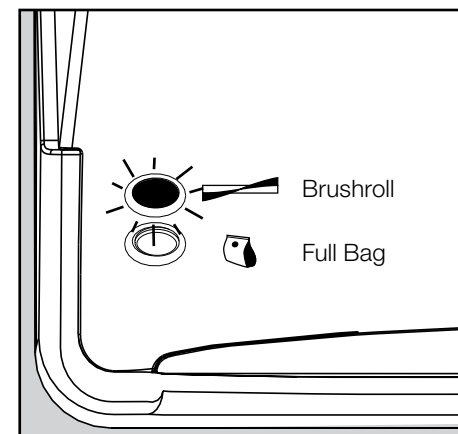

Red Warning Light

Thermal motor protection

Your Brilliance is equipped with a safeguard to recognize when the vacuum heats up and shuts down to protect your vacuum cleaner. Note that when this happens, the headlight is still on but the motors shut off. Common reasons why a vacuum may overheat include operating a vacuum with a full bag or when there is a clog in the vacuum.

- Unplug the vacuum.
- Inspect your vacuum for a full bag condition or a hose clog and correct the problem. Locate the Thermal Motor Reset button on the back of the vacuum. Press button and resume vacuuming.

If problem continues, contact your Authorized Riccar Retailer.

Thermal Reset
 1. Unplug machine
 2. Locate problem source (clogged hose or full bag)
 3. Correct problem
 4. Press reset button
 If problem persists, consult owner's manual or contact retailer.

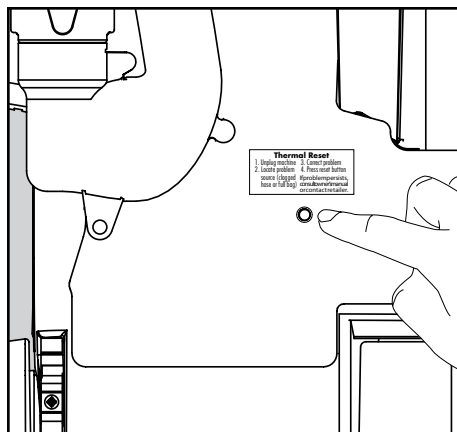

Trouble Shooting

PROBLEM	POSSIBLE REASON	POSSIBLE SOLUTION
Vacuum won't turn on	<ul style="list-style-type: none"> • Power cord not firmly plugged in • Blown fuse or tripped breaker • Needs service 	<ul style="list-style-type: none"> • Plug unit in firmly • Check house fuse or breaker. Replace fuse / reset breaker. • Take to Authorized Retailer (1-888-6-RICCAR)
Vacuum won't pick up or low suction	<ul style="list-style-type: none"> • "Carpet" switch not on • Vacuum bag full • Clogged filter • Hose clogged • Worn brushroll • Broken belt • Tool activation dial turned on 	<ul style="list-style-type: none"> • Turn "carpet" switch on • Install new bag • Install new filter • Remove obstacle • Replace brush strips • Take to Authorized Retailer for belt replacement • Turn tool activation dial to "off" position
Dust escaping from vacuum	<ul style="list-style-type: none"> • Dust cover not seated properly • Filter not installed correctly • Vacuum bag not installed correctly 	<ul style="list-style-type: none"> • Reinsert the dust cover and secure latch • Review filter installation (page 20) • Review bag installation (page 19)

Any other service should be done by an Authorized Service Representative.

Service 1-888-6-RICCAR

To locate your nearest retailer, visit our website at www.riccar.com

Warranty

What is Covered:

This warranty covers any defects in material and workmanship in your new Riccar Brilliance vacuum.

How Long Coverage Lasts:

Warranty coverage for your Riccar vacuum lasts five years for household use.

What is Not Covered:

- Damage to the vacuum which occurs from neglect, abuse, alterations, accident, misuse or improper maintenance.
- Normal replacement items: disposable bags, disposable filters, light bulbs and agitator brushes.
- Damage associated with or resulting from the use of non-genuine parts including normal replacement items.

What Riccar Vacuums Will Do:

This warranty provides, at no cost to you, all labor and parts to keep this vacuum in correct operating condition during the warranted period.

How to Get Service:

Warranty service can only be obtained by presenting the vacuum to an Authorized Riccar Retailer. A proof-of-purchase and product serial number will be required before service is rendered. **To locate your nearest Riccar Retailer, please call 1-888-6-RICCAR or visit the Riccar website at www.riccar.com.**

THIS WARRANTY IS EXCLUSIVE AND IN LIEU OF ANY AND ALL OTHER WARRANTIES WHETHER WRITTEN, ORAL, EXPRESSED OR IMPLIED, (INCLUDING ANY WARRANTY OF MERCHANTABILITY OR FITNESS FOR A PARTICULAR PURPOSE). THIS WARRANTY DISCLAIMS LIABILITY FOR INCIDENTAL, OR CONSEQUENTIAL DAMAGES.

How State Law Applies:

This warranty gives you specific legal rights, and you may also have other rights which vary from state to state.

Register your warranty on-line at www.riccar.com

Owner's Warranty Information

keep this for your records...

Date of purchase _____

Serial number _____

Model number _____

Purchased from:

Store name _____

Address _____

City, State, Zip _____

Telephone _____

RICCAR®

RICCAR®
www.riccar.com