

ROBERTS

Sound for Generations

MP-23

CD/AM/FM RDS/DAB digital sound system with
MP3/WMA/SD/USB and remote control

MP-SOUND 23



Please read this manual before use

DAB

Digital Audio Broadcasting

Contents

<i>MP-23 Sound features</i>	2	<i>FM Stereo/Mono</i>	22
<i>Controls</i>	3-5	<i>Operating your radio - Search tuning MW</i>	23
<i>Remote handset battery replacement</i>	6	<i>Manual tuning - FM and MW</i>	24
<i>Mains operation</i>	6	<i>Presetting stations</i>	25
<i>Setting the clock</i>	7	<i>Equalizer function</i>	26
<i>Using your system for the first time</i>	8	<i>Mute function</i>	26
<i>Selecting the MP-23 modes</i>	9	<i>Sleep function</i>	27
<i>Operating your radio - DAB</i>	10	<i>Compact discs</i>	28-31
<i>Selecting a station - DAB</i>	11	<i>MP3/WMA CD mode</i>	32-35
<i>Secondary services - DAB</i>	11	<i>Using SD cards or USB memory devices</i>	36-40
<i>Display modes - DAB</i>	12	<i>Alarm</i>	41-44
<i>Finding new stations - DAB</i>	13	<i>System reset</i>	45
<i>Manual tuning - DAB</i>	14	<i>Clock display</i>	46
<i>Signal strength display - DAB</i>	14	<i>3D Sound switch</i>	46
<i>Using your radio's Pauseplus feature</i>	15-16	<i>Auxiliary In socket</i>	47
<i>Station order setup - DAB only</i>	17	<i>Line Out socket</i>	47
<i>Prune stations - DAB only</i>	18	<i>Headphone and optical output sockets</i>	48
<i>Software version - DAB only</i>	18	<i>General</i>	49
<i>Dynamic Range Control (DRC) settings - DAB only</i>	19	<i>Specifications</i>	49
<i>Operating your radio - Search tuning FM</i>	20	<i>Mains supply</i>	50
<i>Automatic programme type search - FM</i>	21	<i>Notes</i>	51-53
<i>Display modes - FM RDS</i>	22	<i>Guarantee</i>	54

MP-23 Sound System features

The Roberts MP-23 Sound system provides the following features in an attractive compact unit.

Radio

The MP-23 can receive DAB, FM (with RDS), and AM (Medium Wave) bands.

CD

The MP-23 plays audio CDs (can also play CDR, CDRW discs)

CD-MP3/WMA

The MP-23 plays MP3 and WMA files which have been recorded to CDR or CDRW.

SD slot and USB socket

The MP-23 plays MP3 and WMA files from SD cards or USB memory devices.

Auxiliary input

The MP-23 can be used as an amplifier and loudspeaker system for external MP3 players, mini disc players and similar devices.

Headphone output

A standard 3.5mm headphone socket is provided for private listening.

Digital output

An optical output is provided for connection to AV receivers, mini-disc recorders or other devices with a digital input.

Line Out socket

A standard 3.5mm Line Out socket is provided for connecting the audio signal to an external amplifier.

Surround effect

An optional 3D surround effect provides enhanced stereo sound.

Acoustically tuned cabinet

The quality enclosure includes bass ports and internal bracing to offer optimal sound reproduction.

Controls

(Front)

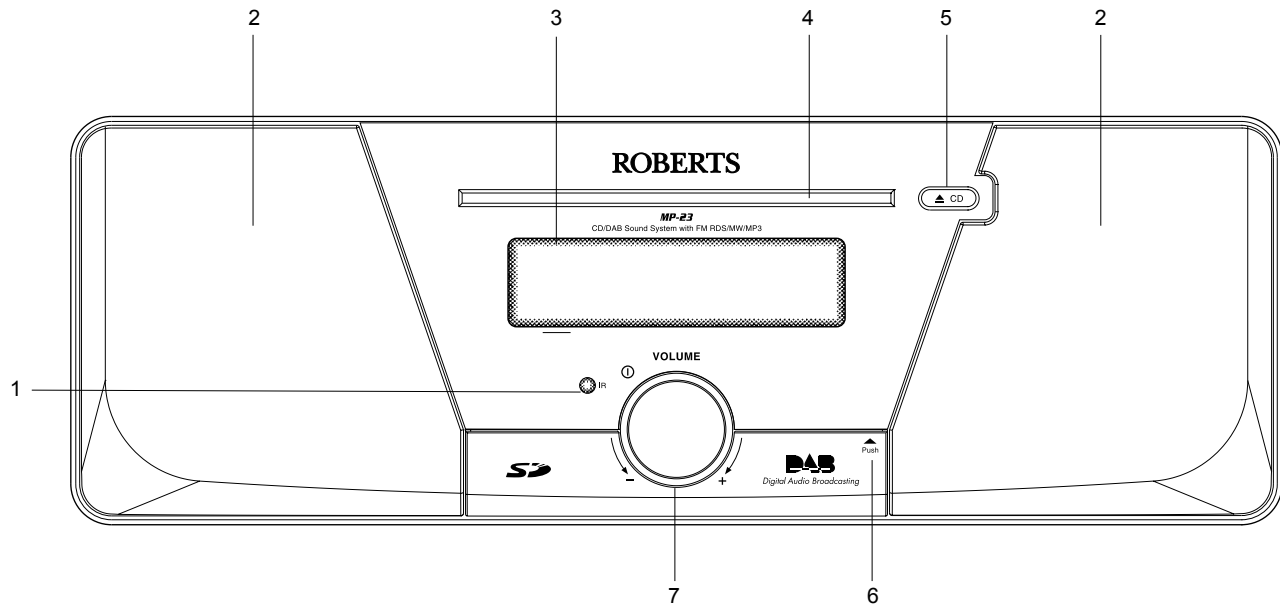

1. Infra red sensor
2. Loudspeakers
3. LCD display
4. CD slot

5. CD Eject button
6. SD card door
7. On/Off/Volume control

Controls

(Rear)

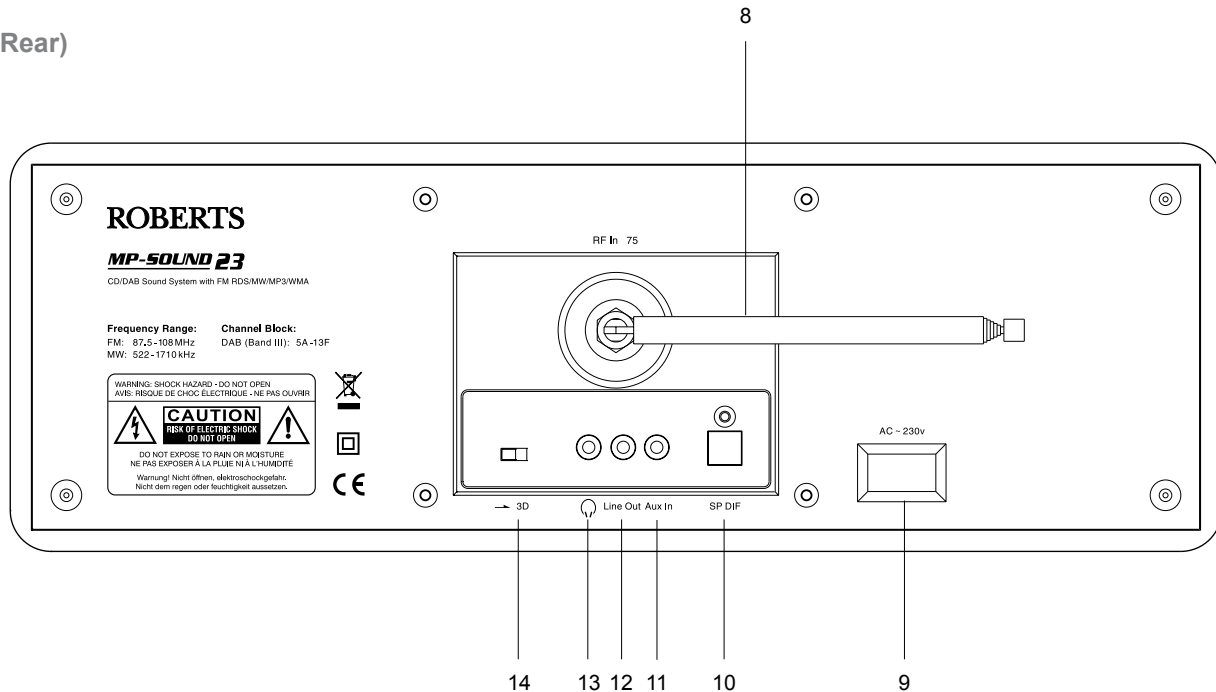

- 8. Telescopic aerial
- 9. Mains input socket
- 10. Optical output socket (Toslink)
- 11. Auxiliary in socket
- 12. Line Out socket
- 13. Headphone socket
- 14. 3D Sound switch

If you need any further advice, please call our Technical Helpline on :-
020 8758 0338 (Mon-Fri)

Remote control

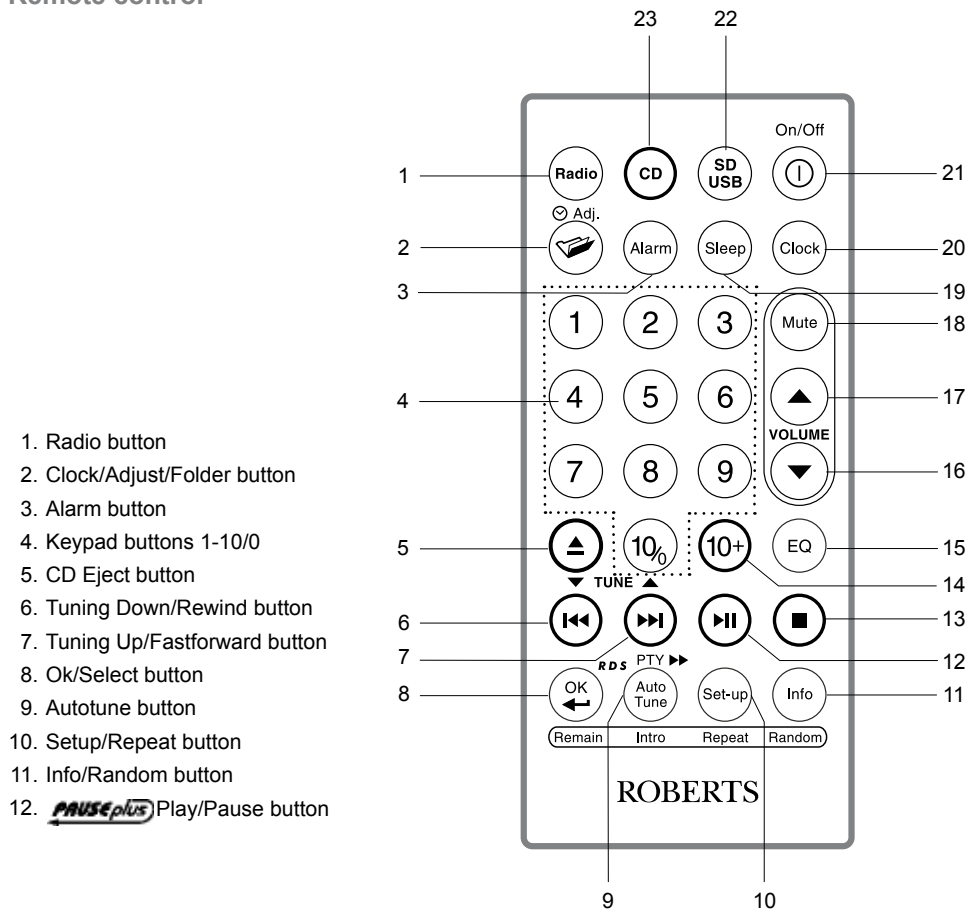

- 13. Stop button
- 14. Direct track access button
- 15. Equalizer button
- 16. Volume Down button
- 17. Volume Up button
- 18. Mute button
- 19. Sleep button
- 20. Clock button
- 21. On/Off button
- 22. SD/USB button
- 23. CD button

Remote handset battery replacement

1. Press in the tab on the left hand side of the battery tray and slide the tray out.
2. Remove battery holder by pushing holder in direction shown.
3. Remove battery from holder.
4. Replace battery (CR2025 or equivalent) ensuring that the positive side of the battery faces you with holder positioned as shown.
5. Replace the battery holder.

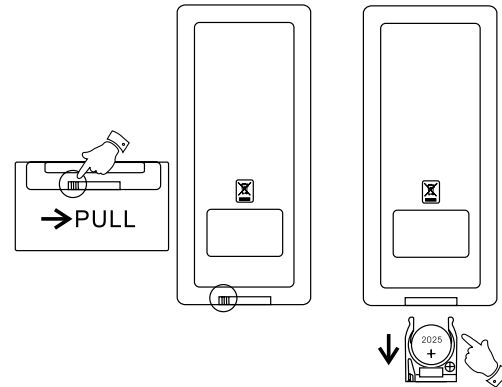

Mains operation

1. Place your radio on a flat surface.
2. Plug the mains lead into the **Socket** located on the rear of your radio ensuring that the plug is pushed fully into the socket.
3. Plug the other end of the mains lead into a wall socket and switch on the wall socket.
4. The clock digits on the display will flash.
5. To set the clock refer to page 7.

Please note the time must be set before the alarm function can be used.

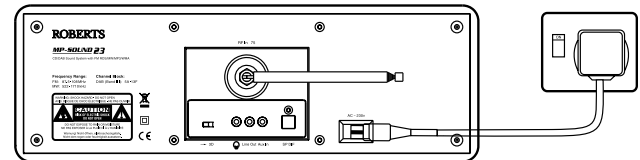

If you need any further advice, please call our Technical Helpline on :-
020 8758 0338 (Mon-Fri)

Setting the clock

Leave the unit in Standby while the clock sets. In the event that the clock does not automatically set follow the procedure below.

You will need to set the clock before the alarm function can be set. The clock display will be 24hr format.

1. Press and hold the **Clock/Adjust button**, the hour digits on the display will flash.
2. Press the **Tuning Up or Down buttons** until the desired hour digit is set.
3. Press and release the **Clock/Adjust button**, the minute digits on the display will flash.
4. Press the **Tuning Up or Down buttons** until the desired minute digit is set. If the button is held down the digits will change more quickly.
5. Press the **Clock/Adjust button** to confirm the clock setting.

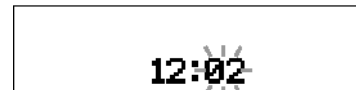
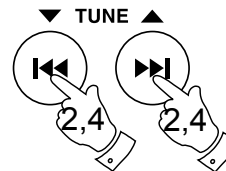
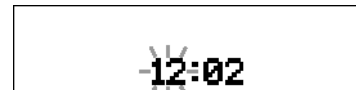
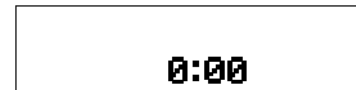

Using your system for the first time

1. Fully extend the telescopic aerial.
2. Press the **On/Off button** to switch on your radio.
3. If this is the first time the sound system is used the display will show "CD" and will enter CD mode. If the sound system has been used before the last used mode will be selected.

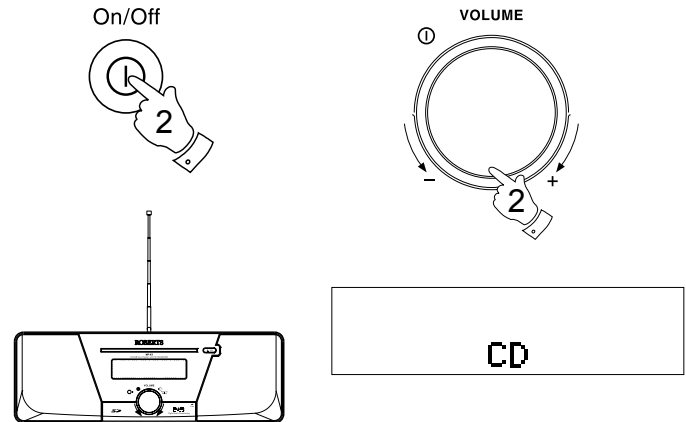

Selecting the MP-23 modes

To select DAB

1. Press and release the **Radio button** until "DAB" shows on the display and the unit will enter the DAB mode. See page 10.

To select CD

1. Press and release the **CD button** until "CD" shows on the display and the unit will enter the CD mode. See page 29.

To select FM/MW

1. Press and release the **Radio button** until "FM Tuner" or "AM Tuner" shows on the display and the unit will enter the FM or the MW mode. See page 20, 23.

To select SD card/USB

1. Press and release the **SD/USB button** until "SD Card" or "USB" shows on the display and the unit will enter either the SD card or USB mode. See page 36.

To select Auxiliary

1. Press and release the **Radio button** until "Aux" shows on the display and the unit will enter Auxiliary mode. See page 47.

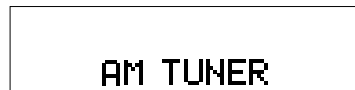
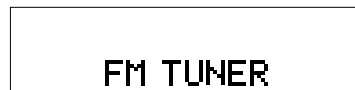

Operating your radio - DAB

1. Fully extend the telescopic aerial.
2. If your sound system is in standby mode, press the **On/Off button** to switch on your radio.
3. Repeatedly press and release the **Radio button** until "DAB" shows on the display. The display will show "Welcome to digital radio" for a few seconds.
4. If this is the first time the radio is used a quick scan of UK Band III DAB channels will be carried out. The display will show "Searching". If the radio has been used before the last used station will be selected.
5. During autotune new stations are detected and will be added to the list.
6. When the Auto tune is complete the first station (in numeric-alpha order 0...9...A...Z) will be selected.
7. If the station list is still empty after the Autotune your radio will display "No Stations available".
8. If no signals are found it may be necessary to relocate your radio to a position giving better reception.

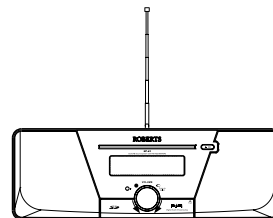
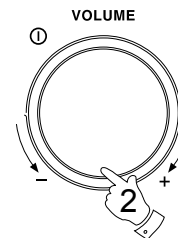

DAB

Welcome to
Digital Radio

Searching...
■■■■■■■■■■■■■■■■■■■■

BBC 7
Now tuning...

BBC 7
Just a Minute...

No stations
available

Selecting a station - DAB

1. The top line of the display shows the name of the station currently selected.
2. Press the **Up or Down Tuning buttons** to scroll through the list of available stations. Stop pressing the **Tuning buttons** when you find the station that you wish to hear.
3. Press and release the **Ok/Select button** to select the station. The display may show "Tuning" while your radio finds the new station.
4. Adjust the **Volume and 3D Sound switch** to the required settings.

Note: If after selecting a station the display continues to show "Station not available" it may be necessary to relocate your radio to a position giving better reception.

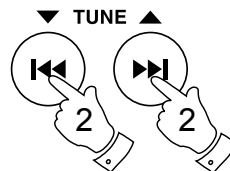

Classic



Classic FM
Tuning...

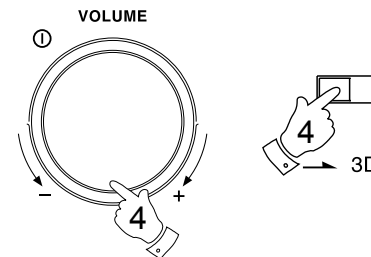

Secondary services - DAB

1. Certain radio stations have one or more secondary services associated with them. If a station has a secondary service associated with it the display will show ">>" next to the station name on the station list. The secondary service will then appear immediately after the primary service as you press the **Tuning Up button**.
2. Press and release the **Ok/Select button** to select the station.



BBC Radio 5
+ BBC 5 Live >> +

BBC Radio 5
+ << BBC Sport < +

Display modes - DAB

Your radio has seven display modes:-

1. Press the **Info button** to cycle through the various modes.



- | | |
|------------------------|---|
| a. Scrolling text | Displays scrolling text messages such as artist/track name, phone in number, etc. |
| b. Programme type | Displays type of station being listened to e.g. Pop, Classic, News, etc. |
| c. Multiplex Name | Displays name of multiplex to which current station belongs. |
| d. Time and date | Displays current time and date. |
| e. Channel & frequency | Displays channel number and frequency. |
| f. Bit rate/audio type | Displays the digital bit rate and audio type. |
| g. Signal error | Displays signal error for station being listened to. |

- | | |
|---|---------------------------|
| a | BBC 7
Just a Minute... |
| b | BBC 7
Culture |
| c | BBC 7
BBC National |
| d | BBC 7
19:17 08-06-2005 |
| e | BBC 7
11C 220.35 MHz |
| f | BBC 7
128kbps Stereo |
| g | BBC 7
Signal error 0 |

Finding new stations - DAB

As time passes new stations may become available. To find new stations proceed as follows:-

1. Press and release the **AutoTune button**, the display will show "Scanning". Your radio will perform a scan of the UK DAB frequencies. As new stations are found the station counter on the right-hand side of the display will increase and stations will be added to the list.
2. To carry out a full scan of the entire DAB Band III frequencies press and hold down the **AutoTune button** for more than 2 seconds and then release. The display will show "Scanning". As new stations are found the station counter on the right-hand side of the display will increase and stations will be added to the list.

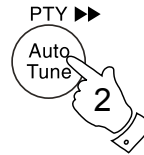
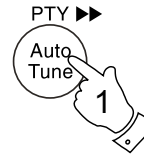

Manual Tuning - DAB

Manual tuning allows you to tune directly to the various DAB Band III channels. UK DAB stations are located in the range 11B to 12D.

1. Press and release the **Setup button** until the display shows "Station order".
2. Press the **Tuning Up or Down buttons** until "Manual tune" appears on the display. Press and release the **Ok/Select button**.
3. Press the **Tuning Up or Down buttons** to select the required DAB channel.
4. Press and release the **Ok/Select button** to select the channel.
5. Any new stations that are found are automatically added to the stored list of stations.
6. Press and release the **Ok/Select button** to return to normal tuning mode.

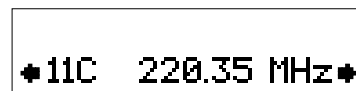
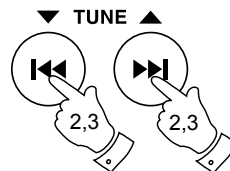

Signal strength display - DAB

1. Press and release the **Ok/Select button** the lower line of the display shows signal strength. Position your radio and angle the telescopic aerial for best reception using the signal strength display as a guide. Move your radio around and position so as to give maximum number of black rectangles on signal strength display.
2. The clear unfilled rectangle indicates minimum signal level required for satisfactory reception. Press and release the **Ok/Select button** to return to normal tuning mode.



Using your radio's Pauseplus feature

How many times has your favourite radio station been interrupted by that phone call from a double glazing firm or someone selling that must have item? Sound familiar? Now with a single press of the **PAUSEplus** button you can put your favourite station on hold while you answer that important call. After the call or other important task is finished simply press the **PAUSEplus** button to return to your favourite station exactly where you left off so that you never miss a single word.

Radio stations can effectively be put on hold between 5 and 15 minutes depending on the station you are listening to.

Note the **PAUSEplus feature only operates on the DAB waveband.**

1. To place your radio in **PAUSEplus** mode simply press the **PAUSEplus** button, the sound from the loudspeaker will be muted. The display will show the "Pause symbol" and the time that you are delayed by.
2. To return to the radio station that you were listening to simply press the **PAUSEplus** button and your radio will continue playing from where you left off.
3. To return to real time press in and release the **Stop button**, the display will return to normal radio display.



```
BBC 7    11-00:12
Just a Minute...
```



```
BBC 7    -00:12
Just a Minute...
```

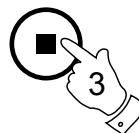

```
Classic FM    DAB
Just a Minute...
```

Pauseplus Rewind and fastforward - DAB

1. Press the **PAUSEplus** button and press and hold the **Tuning Up/Fast-forward** or **Tuning Down/rewind buttons** to scroll to the item you wish to listen.
2. When using your radio's **PAUSEplus** feature the top line of display automatically switches to show the time that you are delayed.



BBC 7 11-00:12
Just a Minute...

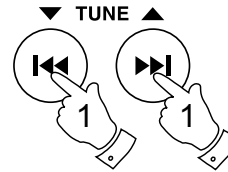

Station order setup - DAB only

Your radio has 3 station order settings from which you can choose. The station order settings are, favourite station, alphanumeric and active station.

Note: Your radio default station order is alphanumeric.

1. Press and release the **Setup button** until "Station order" appears on the display. Press the **Ok/Select button** to enter setup.
2. Press the **Tuning Up or Down buttons** to choose between favourite station, alphanumeric and active station.

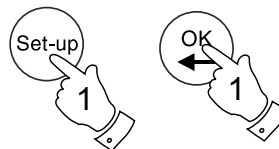

◆ ◆ or SELECT
◆ Station order ◆

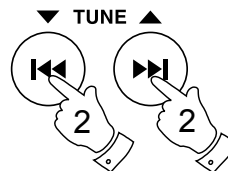

Favourite stations

When this setting is switched on, after a period of time the most listened to stations will move to the top of the station list and will be marked with the heart symbol ♥.

◆ ◆ or SELECT
◆ Fav station ♥ ◆

Alphanumeric

Press the **Tuning Up and Down buttons** until "Alphanumeric" appears on the display. Your radio will now select stations in alphanumeric order A...Z 0...9.

◆ ◆ or SELECT
◆ Alphanumeric ◆

Active station

Press the **Tuning Up or Down buttons** until "Active station" appears on the display. The display will show only those that a signal can be found.

3. Press and release the **Ok/Select button** to select the station order setting required.



◆ ◆ or SELECT
◆ Active station ◆

Prune stations - DAB only

Some DAB services may stop broadcasting or you may not be able to receive a station. Prune stations will delete the DAB stations from your station list that can no longer be received.

1. Press and release the **Setup button** until "Station order" appears on the display. Press and release the **Ok/Select button**.
2. Press the **Tuning Up or Down buttons** until "Prune stations" appears on the display.
3. Press and release the **Ok/Select button** to select.



```
◆ ◆ or SELECT
◆ Station order ◆
```

```
◆ ◆ or SELECT
◆ Prune station ◆
```

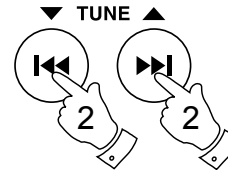

Software version - DAB only

The software display cannot be altered and is for your reference only.

1. To view the software version your radio has, press and release the **Setup button** until "Station order" appears on display.
2. Press the **Tuning Up or Down buttons** until "Software version" appears on the display. The software version will appear on the display.



```
◆ ◆ or SELECT
◆ Station order ◆
```

```
◆ V.35.1.4
◆ Sw Version ◆
```

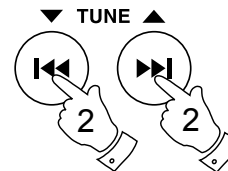

Dynamic Range Control (DRC) settings - DAB only

DRC can make quieter sounds easier to hear when your radio is used in a noisy environment. This function is only for the DAB waveband.

1. Press the **On/Off button** to switch on your radio.
2. Press and release the **Setup button** until "Station order" appears on the display.
3. Press and release the **Tuning Up and Down buttons** until the display shows "DRC value".
4. Press and release the **Ok/Select button** to enter adjustment mode.
5. Press and release the **Tuning Up or Down buttons** to select required DRC setting (default is 0) .
 - DRC 0 DRC is switched off, Broadcast DRC will be ignored.
 - DRC 1/2 DRC level is set to 1/2 that sent by broadcaster.
 - DRC 1 DRC is set as sent by broadcaster.
6. Press and release the **Ok/Select button** to confirm the setting. The display will return to radio mode.

On/Off

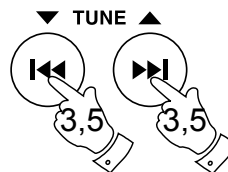

◆ ◆ or SELECT
◆ Station order ◆

◆ ◆ or SELECT
◆ DRC value ◆

DRC0
◆ DRC0 ◆

DRC0
◆ DRC 1/2 ◆

DRC0
◆ DRC 1 ◆

Operating your radio - Search tuning FM

1. Fully extend the telescopic aerial.
2. Press the **On/Off button** to switch on your radio.
3. Press and release the **Radio button** until the FM band is selected.
4. Press and hold the **Tuning Up button**, your radio will scan in an upwards direction (low frequency to high frequency) and stop automatically when it finds a station of sufficient strength.
5. After a few seconds the display will update. If the FM band is selected the display will show the station name if available.
6. To find other stations press and hold the **Tuning Up button** as before.
7. To scan the FM band in a downwards direction (high frequency to low frequency) press and hold down the **Tuning Down button** for 0.5 seconds and then release.
8. When the waveband end is reached your radio will recommence tuning from the opposite waveband end.
9. Adjust the **Volume and 3D Sound switch** to the required settings.
10. To switch off your radio press the **On/Off button**.

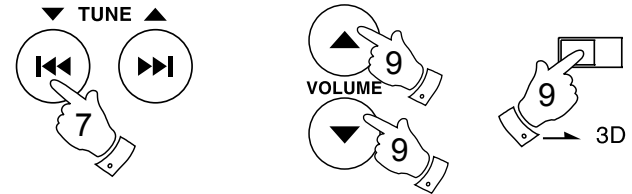
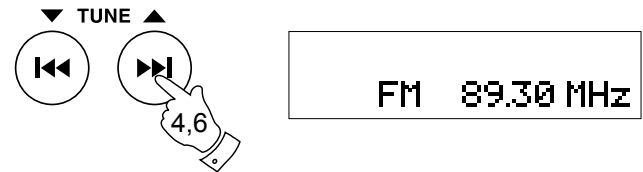
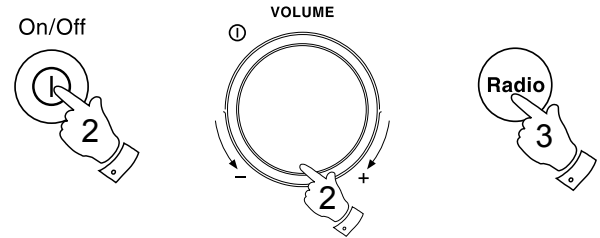

Automatic programme type search - FM

Your radio can automatically search for a programme type such as news, sport etc and will tune in to a station transmitting this information.

1. Fully extend the telescopic aerial.
2. Press the **On/Off button** to switch on your radio.
3. Press and release the **Radio button** to select the FM band.
4. Press and release the **Auto tune button**, the radio will enter the programme type mode the first programme type available will show on display.
5. Press and release the **Autotune button** until the required programme type shows on the display.
6. To begin the programme type search press and hold down either the **Tuning Up or Down buttons** for 0.5 seconds. The radio will scan the FM band until it finds a station transmitting your required programme type.
7. If a programme of the specified type is not found the radio will tune to the previously selected station and will show "NO MATCH".
8. To switch off your radio press the **On/Off button**.

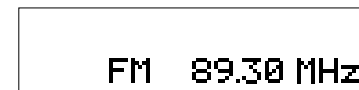
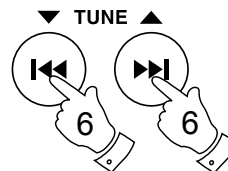
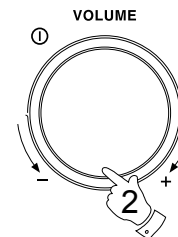

Display modes - FM RDS

Your system has five display modes in FM. The Radio Data System (RDS) is a system in which inaudible digital information in addition to the normal FM radio programme is transmitted.

On FM the bottom line of the display can be set to any of the following modes.

1. Press the **Info button** to cycle through the various modes.
 - a. Station Name Displays the station name currently being transmitted
 - b. Programme Type Displays type of station being listened to e.g. Pop, Classic, News, etc.
 - c. Radio Text Displays radio text messages such as news items etc.
 - d. Time and date Displays current time and date.
 - e. Frequency Displays frequency of the station being listened to.

Note: When tuned to the FM band, information display is only available when the radio is able to receive RDS information from the broadcaster.

FM Stereo/Mono

1. If a station being received is weak some hiss may be audible. To reduce the hiss press and hold in the **Ok/Select button** until the display shows "Mono". Your radio will switch to mono mode.
2. To return to stereo mode press and hold in the **Ok/Select button** until the display shows "Stereo". Your radio will switch to stereo mode.

Note: FM stereo is only available when listening via earphone/headphones



Operating your radio - Search tuning MW

1. For MW there is a built in ferrite aerial. Rotate your radio for best reception.
2. Press the **On/Off button** to switch on your radio.
3. Press and release the **Radio button** to select MW band. The display will show the AM Tuner.
4. Press and immediately release the **Tuning Up button**, your radio will scan in an upwards direction (low frequency to high frequency) and stop automatically when it finds a station of sufficient strength.
5. After a few seconds the display will update.
6. To find other stations press and release the **Tuning Up button** as before.
7. To scan the MW band in a downwards direction (high frequency to low frequency) press and hold down the **Tuning Down button** for 0.5 seconds and then release.
8. When the waveband end is reached your radio will recommence tuning from the opposite waveband end.
9. Adjust the **Volume and 3D Sound switch** to the required settings.
10. To switch off your radio press the **On/Off button**.

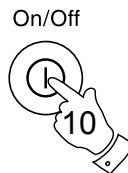
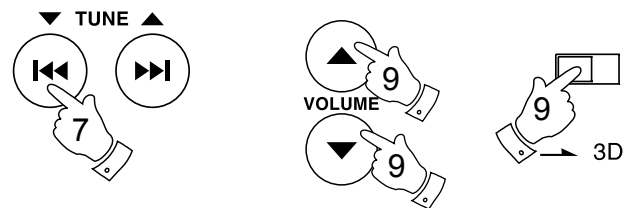
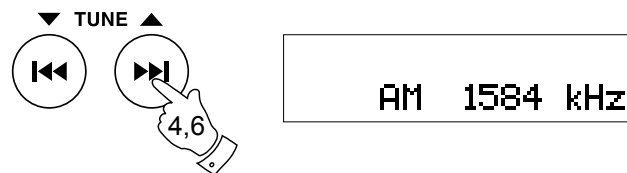
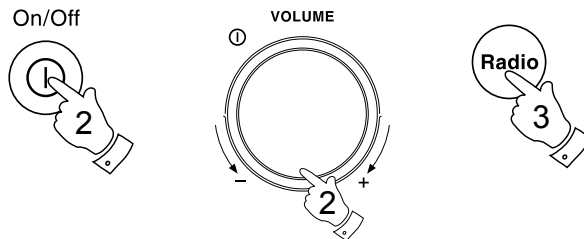

Manual tuning - FM and MW

1. Press the **On/Off button** to switch on your radio.
2. Press and release the **Radio button** to select the FM or MW band. Fully extend the **Telescopic aerial** for FM reception. For MW reception there is a built in ferrite aerial. Rotate your radio to the position giving best reception.
3. Press the **Tuning Up and Down buttons** to tune to a station. The frequency will change in steps of 50kHz on FM. On MW the frequency will change in steps of 9 kHz.
4. When the waveband end is reached the radio will recommence tuning from the opposite waveband end.
5. Set the **Volume and 3D Sound switch** to the desired settings.
6. To switch off your radio press the **On/Off button**.

On/Off

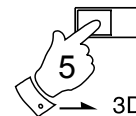
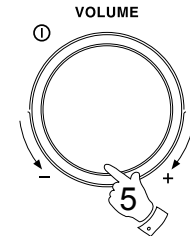
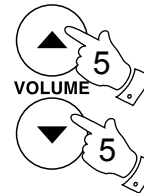
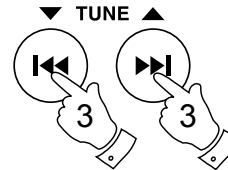

On/Off



Presetting stations

There are 10 memory presets on each of the DAB, MW and FM wavebands.

1. Press the **On/Off button** to switch on your radio.
2. Tune to the required station as previously described.
3. Press and hold down the required **Preset button** (1 to 10) until the display shows e.g. "Preset 1 stored". The station will be stored under the chosen preset button. Repeat this procedure for the remaining presets.
4. Stations stored in preset memories may be overwritten by following

On/Off

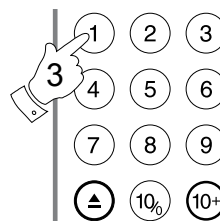

BBC R2
Preset 1 saved

Recalling a preset station

1. Press the **On/Off button** to switch on your radio.
2. Select the required waveband by pressing the **Radio** button.
3. Momentarily press the required **Preset button** (1-10), your radio will tune to the station stored in preset memory.

On/Off

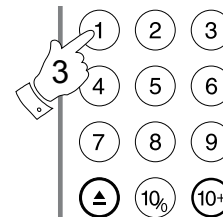

BBC 2
BBC National

Equalizer function

The tone on your sound system can be adjusted to suit the particular broadcast listened to. Your radio has six equalizer modes:-

1. Press the Equalizer button to cycle through the various modes.
 - a. Flat
 - b. Jazz
 - c. Rock
 - d. Classic
 - e. Pop
 - f. News



FLAT

JAZZ

ROCK

CLASSIC

POP

News

Mute function

Pressing the Mute button will mute the output from the loudspeakers.

1. Press the **Mute button** to mute sound output.
2. Press Mute again to return to normal play mode.



MUTE

Sleep function

Your clock radio can be set to turn off after a preset time has elapsed. The sleep setting can be adjusted between 10 and 90 minutes in 10 minute increments.

1. To set the desired sleep time, press the **Sleep button** to enter the sleep setup. "Sleep" will appear on the display.
2. Repeatedly press and release the **Sleep button** to select the desired sleep time 90>80>70>60>50>40>30>20>10 minutes or to OFF to permanently cancel the sleep function.
3. Your radio will switch off after the preset sleep time has elapsed.
4. To cancel the sleep function before the preset time has elapsed, press the **On/Off button**.



On/Off



Compact discs

Use only Digital Audio CDs which have the  symbol.

Never write on a CD or attach any sticker to the CD. Always hold the CD at the edge and store it in its box after use with the label facing up.

To remove dust and dirt, breathe on the CD and wipe it with a soft, lint free cloth in a straight line from the centre towards the edge.

Cleaning agents may damage the CD.

Do not expose the CD to rain, moisture, sand or to excessive heat. (e.g from heating equipment or in motor cars parked in the sun).

CD-R/CD-RW discs

Your MP-23 can playback CD-DA format audio CD-R/CD-RW discs that have been finalised* upon completion of recording.

Your MP-23 may fail to playback some CD-R/CD-RW discs due to poor recording and wide variation in quality of the CD-R/CD-RW disc.

*Finalising enables a CD-R/CD-RW disc to playback on audio players such as your MP-23.

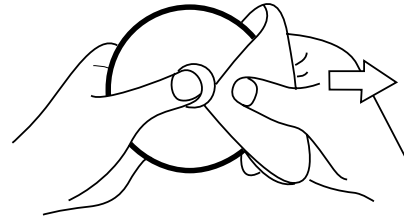

Inserting a CD

When your Sound System is in the standby mode inserting a CD will switch the unit on.

Ensure the cd tray is empty before inserting a CD. If you cannot insert a CD, press the **Cd/Eject button** to ensure the unit is empty.

1. To select the CD mode press the **CD button**.
2. To eject or load a CD press and release the **CD Eject button**.
3. To insert an audio CD, place printed side facing up into the cd compartment. The CD will be automatically loaded. The unit will check the CD type and load its track list. The display will show "loading" and then "reading" as the information is read.
4. If you load a CD with MP3 tracks your sound system will enter the MP3 mode see page 32.

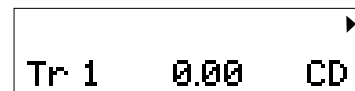
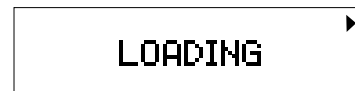

Playing a CD

1. Press the **Play/Pause button** to start playback. The display will show the first track number.
2. Adjust the **Volume** and **3D Sound switch** to the required settings.
3. To pause playback press the **Play/Pause button**. To resume playback press the **Play/Pause button** again.

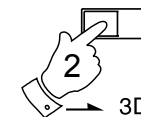
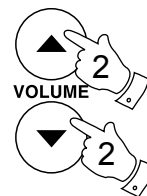

- To stop play, press the **Stop button**. The total number of CD tracks will be displayed.
- To take out the CD, press and release the **CD Eject button**. The display will show "No Disc".

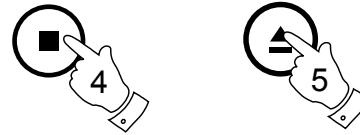

Selecting a track

- Whilst the CD is playing, press either the **Fastforward** or **Rewind buttons** to change to the desired track, the track number appears in the display.
- You can also skip tracks when the player is in stop mode. Skip to the desired track using the **Fastforward** or **Rewind buttons**. Press and hold the button to make the track numbers cycle, release the button when the desired track is displayed.
- Press the **Play/Pause button** to play the selected track.

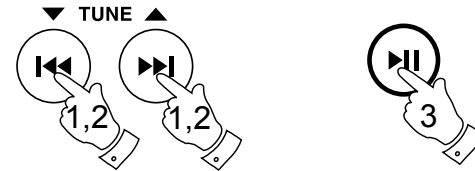

Select a desired track

- For track numbers 1-9 simply press the corresponding digit button.
- For track numbers ten and above press the **direct track access button** then press the required digits.
- If the track number entered exceeds the number of tracks on the CD, then no track will be played.

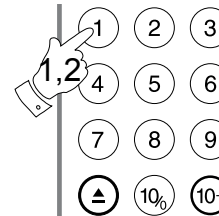

Search function

1. Whilst the CD is playing, press and hold the **Fastforward** or **Rewind** buttons.
2. Release the button when the desired part of the track is reached.

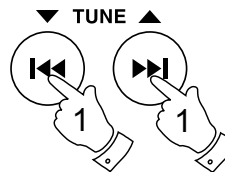

Repeat a single file

1. Whilst the CD is playing, press the **Setup** button until the single track symbol appears in the display. The current track will be repeated.



			◀ 1 ▶
Tr 1	18.20	CD	

Repeat all tracks

1. Whilst the CD is playing, press the **Setup** button until the repeat all tracks symbol appears in the display. All the tracks will be repeated.



			◀ 5 ▶
Tr 1	18.20	CD	

Play files in random order

1. Whilst the CD is playing, press the **Info** button until the random symbol appears in the display. The tracks will be played in random order.



	RAN		▶
Tr 1	18.20	CD	

To stop playing files in random order

1. Whilst the CD is playing, repeatedly press the **Info** button until the random symbol disappears from the display. The CD will return to normal play.



			▶
Tr 1	18.20	CD	

Intro play feature

The button marked Intro will cause the first 10 seconds of each CD track to be played. Press and release this button to allow a specific track to be found without manually selecting tracks. When the desired track is reached, press and release the Intro button again to continue playing the CD normally.

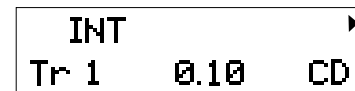
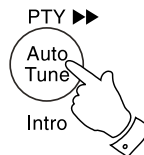

CD time display

The button marked Remain allows different time information to be displayed for the CD or track currently being played. For each press and release of the Remain button will cycle through the following displays, time into current CD track, total time into CD, time remaining on current CD track and total time remaining on CD.

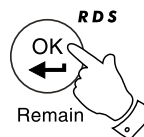

MP3/WMA CD Mode

1. To select the CD mode press the **CD button**.

The MP-23 is able to play CD-R and CD-RW discs containing MP3 and WMA files.

In MP3/WMA mode the terms "album" and "file" are very important. "Album" corresponds to a folder on a PC, "File" to a PC or a CD-DA track. The device reads MP3 files with a maximum of 255 files per album. An MP3 CD may not contain more than 512 files or albums in total. MP3 and WMA files must be created with an audio sample rate of 44.1kHz (this is normal for files created from CD audio content).

When burning CD-R and CD-RWs with audio files, various problems may arise which could lead to interference in playback. This can be caused by faulty software or hardware settings or by the CD being used. Should such problems arise, contact the customer services of your CD burner or software manufacturer or look for relevant information, for example on the internet. When you are making audio CDs, observe all legal guidelines and ensure that the copyright of third parties is not infringed.



Playing an MP3/WMA CD

1. Press the **Play/Pause button** to start playback. The display will show the first track number.
2. Adjust the **Volume** and **3D Sound switch** to the required settings.
3. To pause playback press the **Play/Pause button**. To resume playback press the **Play/Pause button** again.
4. To stop play, press the **Stop button**. The total number of CD tracks will be displayed.
5. To take out the CD, press and release the **CD Eject button**. The display will show "OPEN".

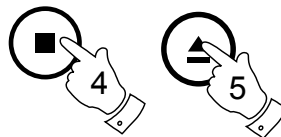
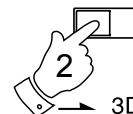
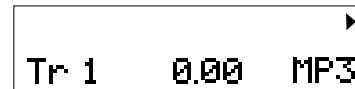

Selecting a track

1. Whilst the CD is playing, press either the **Fastforward** or **Rewind buttons** to change to the desired track, the track number appears in the display.
2. You can also skip tracks when the player is in stop mode. Skip to the desired track using the **Fastforward** or **Rewind buttons**. Press and hold the button to make the track numbers cycle, release the button when the desired track is displayed.
3. Press the **Play/Pause button** to play the selected track.

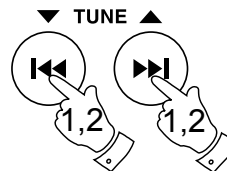

Select a desired track

1. For track numbers 1-9 simply press the corresponding digit button.
2. For track numbers ten and above press the **direct track access button** then press the required digits.
3. If the track number entered exceeds the number of tracks on the CD, then no track will be played.

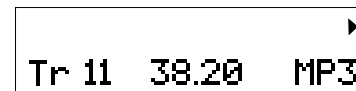
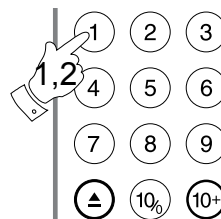
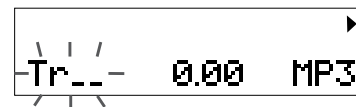

Search function

1. Whilst the MP3 CD is playing, press and hold the **Fastforward** or **Rewind buttons**.
2. Release the button when the desired part of the track is reached.

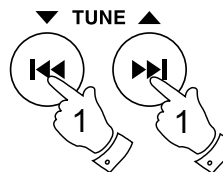

To skip to the next folder

1. Whilst the MP3 CD is in stop or play mode, press and release the **Folder button**.
2. The first file of the next folder will be played.

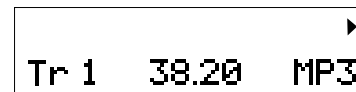

(1)

Repeat a single MP3 file

1. Whilst the MP3 CD is playing, press the **Setup button** until the single track symbol appears in the display. The current track will be repeated.



			\$1 ▶
Tr 1	18.20	MP3	

Repeat all MP3 tracks

1. Whilst the MP3 CD is playing, press the **Setup button** until the repeat all tracks symbol appears in the display. All the tracks will be repeated.



			\$ \$ ▶
Tr 1	18.20	MP3	

Repeat all MP3 tracks in a single album

1. Whilst the MP3 CD is playing, press the **Setup button** until the repeat all tracks in a single album symbol appears in the display. All the tracks within that album will be repeated.



			\$b ▶
Tr 1	18.20	MP3	

Play files in random order

1. Whilst the MP3 CD is playing, press the **Info button** until the random symbol appears in the display. The tracks will be played in random order.



		RAN	▶
Tr 11	38.20	MP3	

To stop playing files in random order

1. Whilst the MP3 CD is playing, repeatedly press the **Info button** until the random symbol disappears from the display. The MP3 CD will return to normal play.



			▶
Tr 11	38.20	MP3	

Using SD cards or USB memory devices

Secure Digital (SD) cards or USB memory devices can be used with the MP-23 for playback of MP3 or WMA files.

Many different brands and capacities of SD card are available. Your MP-23 has been tested with the most popular cards and USB device up to 1 GB. However, there are many different card variants available and not all cards can be guaranteed to work in the MP-23.

SD card and USB slots are located behind the panel beneath the volume control. This is opened by pushing and releasing the right hand top corner of the panel. To close the panel, press in the panel door until it clicks into place.

Do not attempt to open or close the panel door using the left hand edge as this may distort or damage the panel.

Inserting and removing a card

To insert an SD card into your radio push the card label side forward and gold contacts first into the SD card slot on the front of your radio until it clicks.

To remove the card push the card in slightly and it will pop out allowing removal.

USB memory devices plug into the rectangular slot on the right hand side, under the panel.

1. To select SD card or USB mode press the ***SD/USB button***.

*If you need any further advice, please call our Technical Helpline on :-
020 8758 0338 (Mon-Fri)*

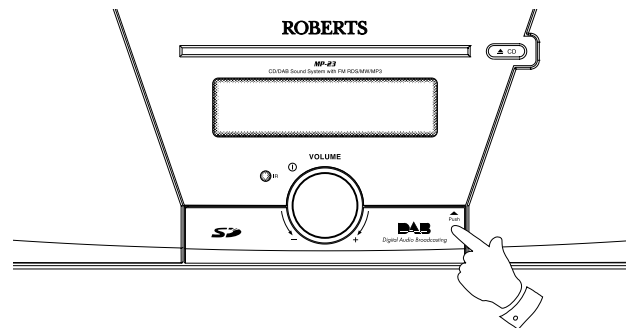

Playing MP3/WMA files - SD card/USB

1. Press the **Play/Pause button** to start playback. The display will show the first track number.
2. Adjust the **Volume** and **3D Sound switch** to the required settings.
3. To pause playback press the **Play/Pause button**. To resume playback press the **Play/Pause button** again.
4. To stop play, press the **Stop button**. The total number of MP3 tracks will be displayed.

Note: The SD card/USB memory device should only be removed when the unit is in stop mode.

You may find that although you have added files to either an SD card or a USB memory device, the MP-23 is unable to identify the files and may report "No data". In this event, we recommend that the card or memory should be reformatted in your computer. Before doing this, you should copy all files and folders on the card to your computer for temporary storage. After the format process is completed, then you should copy the files back again. If the MP-23 is still unable to read the files, then it is likely that your SD or USB memory device is not completely compatible in some way.

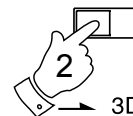
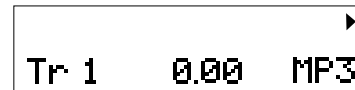

Selecting a track

1. Whilst the MP3/WMA file is playing, press either the **Fastforward** or **Rewind buttons** to change to the desired track, the track number appears in the display.
2. You can also skip tracks when the player is in stop mode. Skip to the desired track using the **Fastforward** or **Rewind buttons**. Press and hold the button to make the track numbers cycle, release the button when the desired track is displayed.
3. Press the **Play/Pause button** to play the selected track.

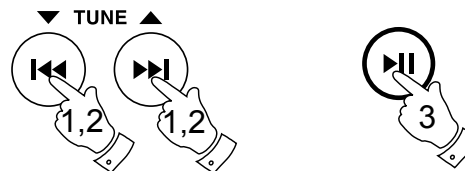

Select a desired track

1. For track numbers 1-9 simply press the corresponding digit button.
2. For track numbers ten and above press the **direct track access button** then press the required digits.
3. If the track number entered exceeds the number of tracks on the CD, then no track will be played.

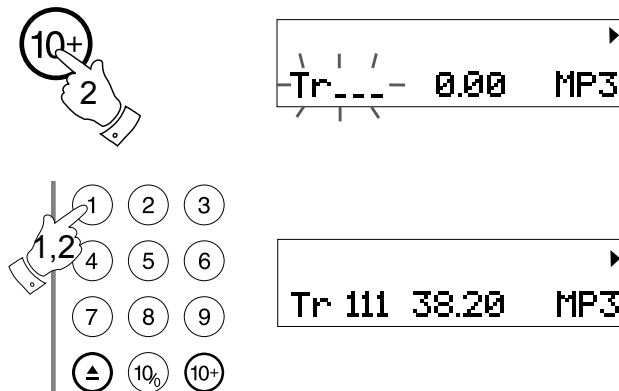

Search function

1. Whilst the MP3/WMA file is playing, press and hold the **Fastforward** or **Rewind buttons**.
2. Release the button when the desired part of the track is reached.

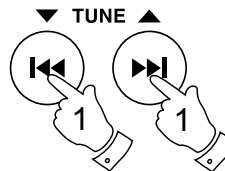

To skip to the next folder

1. Whilst the unit is in stop mode, press and release the **Folder button**.
2. The first file of the next folder will be played.



(1)

Repeat all MP3/WMA tracks in a single album

1. Whilst the MP3/WMA file is playing, press the **Setup button** until the repeat all tracks in a single album symbol appears in the display. All the tracks within that album will be repeated.



			SB ▶
Tr 1	18.20	MP3	

Play files in random order

1. Whilst the MP3/WMA file is playing, press the **Info button** until the random symbol appears in the display. The tracks will be played in random order.



			RAN ▶
Tr 11	38.20	MP3	

To stop playing files in random order

1. Whilst the MP3/WMA file is playing, repeatedly press the **Info button** until the random symbol disappears from the display. The unit will return to normal play.



			▶
Tr 11	38.20	MP3	

SD card/USB memory device Intro play

1. Whilst the unit is in stop mode, press the **Autotune/Intro button** once to play the first 10 seconds of all the tracks on the SD card/memory device.
2. Press the **Stop button** to interrupt Intro play.

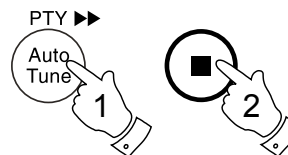

			INT ▶
Tr 1	0.10	MP3	

Alarm

Your sound system has an alarm which can be set to wake you to CD, USB, SD card, FM radio, MW radio, DAB or Auxiliary in.

1. Press and release the **Clock button** the clock time will show on the display. Ensure that the clock time is set see page 7.
2. Press and release the **Clock button again** the alarm digits will show on the display and "On" will be displayed next to the alarm symbol.
3. Press and release the **Clock/Adjust button** to adjust the alarm hour digits. The alarm hour digits will flash.
4. Press the **Tuning Up or Down** to select the required alarm hour.
5. Press and release the **Clock/Adjust button** to adjust the alarm minute digits. The alarm minute digits will flash.
6. Press the **Tuning Up or Down** to select the required alarm minute.

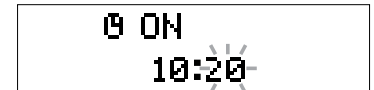
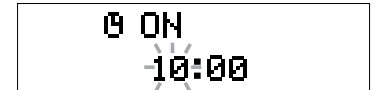
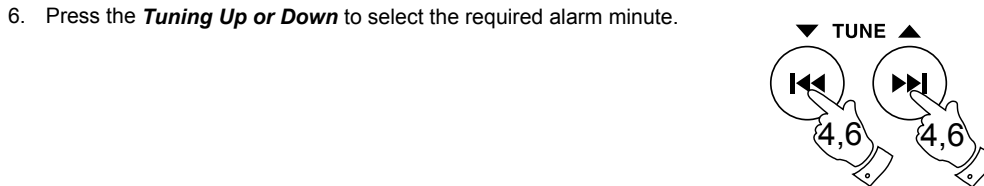
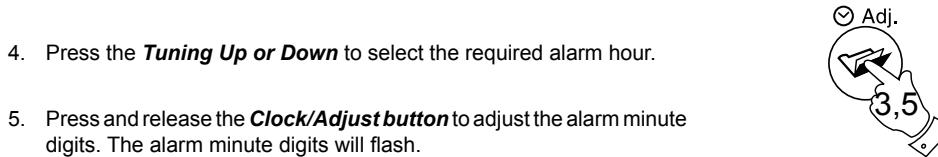
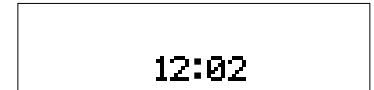

7. Press and release the **Clock button** the alarm off time digits will show on the display and "OFF" will be displayed next to the alarm symbol.

8. Press and release the **Clock/Adjust button** to adjust the alarm off hour digits. The alarm hour digits will flash.

9. Press the **Tuning Up or Down buttons** to select the required alarm hour.

10. Press and release the **Clock/Adjust button** to adjust the alarm off minute digits. The alarm minute digits will flash.

11. Press the **Tuning Up or Down buttons** to select the required alarm minute.

12. Press and release the **Clock button** the previous alarm mode set will show on the display and "SOURCE" will be displayed next to the alarm symbol.

13. Press and release the **Clock/Adjust button** to adjust the alarm mode.

14. Press the **Tuning Up or Down buttons** to select the required alarm mode.

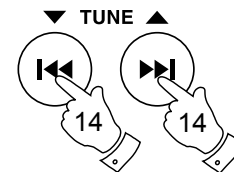
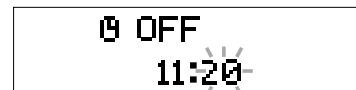
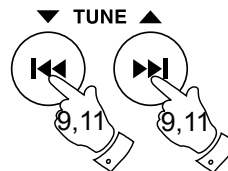
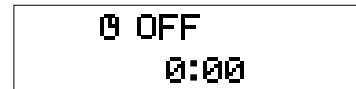

14. Your alarm can be set to the following modes:

- CD - Will wake you from favourite CD
- USB - Will wake you from USB memory device
- SD Card - Will wake you from SD card
- FM Tuner - Will wake you from FM radio station
- AM Tuner - Will wake you from MW radio station
- DAB - Will wake you from DAB radio station
- Aux - Will wake you from your MP3 player

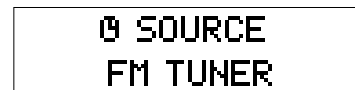

14. Press the **On/Off button** again and the radio will remain in standby mode until the alarm sounds. The alarm symbol  will appear in the display. If the alarm has been enabled. To enable the alarm if needed press and release the alarm button. (see page 44)

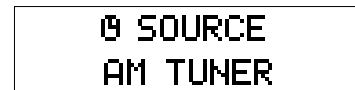

The alarm will sound at the selected alarm time.

The alarm volume will be the volume previously listened to when setting up the alarms.

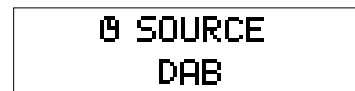

Note: The alarm will not sound if the alarm has not been activated and set to the "Enabled" position. See page 44.

When the alarm is set to wake by radio your sound system will switch on to the last used station.



Switching alarm on or off

1. To turn the alarm On (ENABLED) or Off (CANCEL) press and release the **Alarm button**.
2. The alarm symbol  will appear when the alarm has been enabled.

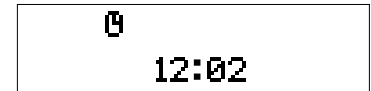

Cancelling alarms

Note: The alarm will activate for the specified alarm duration (maximum 24 hours).

1. Press the **On/Off button** to switch the alarm off.
2. Enter the alarm setup menu and select the alarm mode to the "CANCEL" position.



System reset

If your radio fails to operate correctly, or some digits on the display are missing or incomplete carry out the following procedure.

1. Ensure that your radio is in DAB mode.
2. Press and hold in the **Setup button** until the display shows "Press SELECT to confirm reset...".
3. Press in and release the **Ok/Select button** to select System reset.
4. If DAB was used last then a "Quick scan" of the DAB band will be performed, otherwise a "Quick scan" will be carried out the next time the DAB band is selected.

After a system reset, any DAB preset settings will have been cancelled.

If a problem persists our technical staff would be pleased to help offer any assistance on operating the radio. Our technical helpline number is 020 8758 0338.



Press SELECT to
confirm reset...



Searching...
■■■■□□□□□□□□

BBC 7
Now tuning...

BBC 7
Just a Minute...

Clock display

1. Your radio will display clock time when it is set to Standby mode.

On/Off

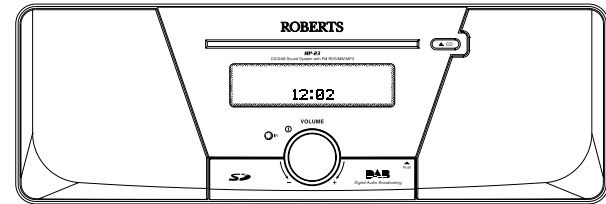

3D sound switch

Your radio speakers may be altered to give a normal or a 3D sound effect.

1. To give 3D sound, switch your **3D sound switch** to 3D position.
2. To give normal sound, switch your **3D sound switch** to normal.

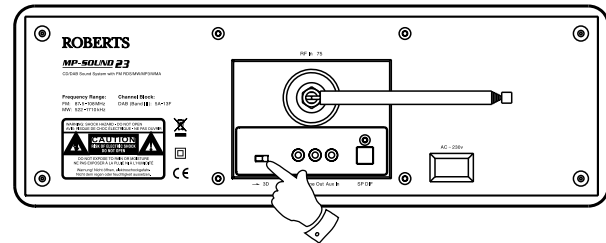

Aux in socket (3.5mm Jack)

1. Repeatedly press and release the **Radio** button until "Aux" is displayed.
2. Connect a stereo or mono audio source (ie iPod, MP3 or CD player) to the **Aux in socket**.
3. Adjust the **Volume control** on your iPod, MP3 or CD player for comfortable listening.

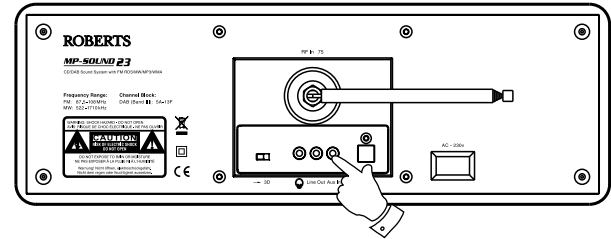

Line Out socket (3.5mm Jack)

A 3.5mm **Line Out socket** located on the rear of your radio is provided for connecting the audio signal to an external amplifier. Inserting an audio cable into this socket will not mute the internal loudspeaker. Set the volume control to minimum if desired.

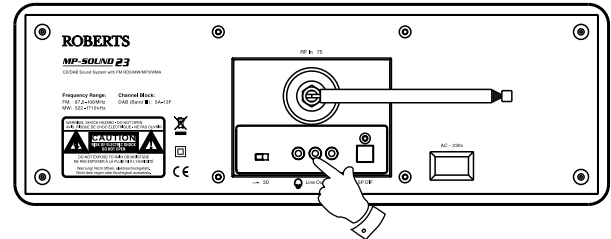

Headphone and optical output sockets

1. A 3.5mm **Headphone Socket** located on the rear of your radio is provided for use with headphones. Inserting a plug automatically mutes the internal loudspeaker.

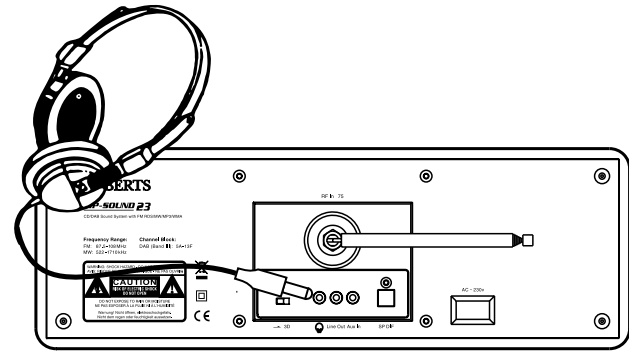

2. A digital optical output socket is provided on the rear of your radio for connection to an amplifier, mini-disc or other equipment with a digital optical input.

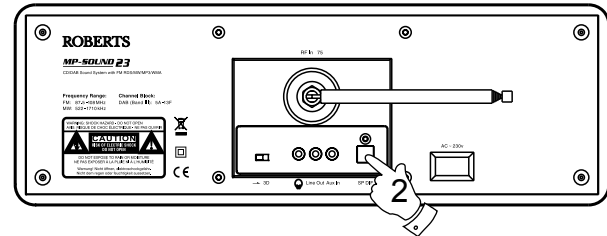

General

Do not allow this radio to be exposed to water, steam or sand. Do not leave your radio where excessive heat could cause damage. It is recommended that the DAB band be used wherever possible as better results in terms of quality and freedom from interference will usually be obtained than on the FM and MW band.



Specifications

Power Requirements

Mains	AC 230 volts, 50Hz  only
Battery (Remote control)	CR2025

Frequency Coverage

FM	87.5-108MHz
DAB	174.928 - 239.200MHz
MW	522 -1620kHz

Circuit features

Loudspeaker		2 x 75 mm
Output Power		8 Watts RMS per channel
Headphone socket		3.5mm dia
Auxiliary in socket		3.5mm dia
Line Out socket		3.5mm dia
Digital optical output socket		Toslink
Aerial System	FM	Telescopic aerial
	DAB	Telescopic aerial
	MW	Built in ferrite aerial

The Company reserves the right to amend the specification without notice.

Mains supply

The MP23 will operate from a supply of AC 230 volts, 50Hz only.

DO NOT cut off the mains plug from this equipment. If the plug fitted is not suitable for the power points in your home or the cable is too short to reach a power point, then obtain an appropriate safety approved extension lead or adaptor. If in doubt consult your dealer.

If nonetheless the mains plug is cut off, remove the fuse and dispose of the plug immediately to avoid a possible shock hazard by inadvertent connection to the mains supply.

If this product is not supplied with a mains plug, or one has to be fitted, then follow the instructions given below:

IMPORTANT. DO NOT make any connection to the larger terminal which is marked with the letter E or by the safety earth symbol  or coloured Green or Green-and-yellow.

The wires in the mains lead are coloured in accordance with the following codes :-

BLUE - NEUTRAL

BROWN - LIVE

The wire coloured BLUE must be connected to the terminal marked N or coloured BLACK.

The wire coloured BROWN must be connected to the terminal marked L or coloured RED.

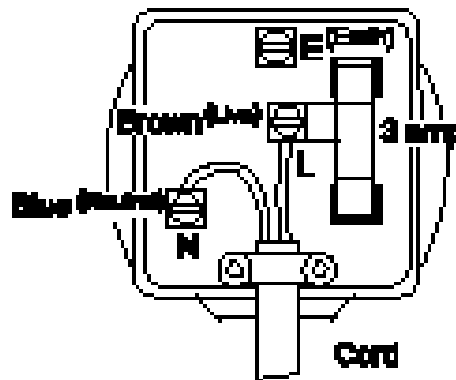

Fuse

When replacing the fuse only a 3A ASTA approved to BS1362 type should be used and be sure to re-fit the fuse cover.

IF IN DOUBT - CONSULT A QUALIFIED ELECTRICIAN.

Replacement fuse holders are available from Roberts Radio Technical Services at the address shown on the rear of this manual.

Notes

Notes

Notes

Guarantee

This instrument is guaranteed for twelve months from the date of delivery to the original owner against failure due to faulty workmanship or component breakdown, subject to the procedure stated below. Should any component or part fail during this guarantee period it will be repaired or replaced free of charge.

The guarantee does not cover:

1. Damage resulting from incorrect use.
2. Consequential damage.
3. Receivers with removed or defaced serial numbers.

N.B. Damaged or broken telescopic aerials will not be replaced under guarantee.

Procedure:

Any claim under this guarantee should be made through the dealer from whom the instrument was purchased. It is likely that your Roberts' dealer will be able to attend to any defect quickly and efficiently but should it be necessary the dealer will return the instrument to the Company's service department for attention. In the event that it is not possible to return the instrument to the Roberts' dealer from whom it was purchased, please contact Roberts Radio Technical Services at the address shown overleaf.



Issue 1

ROBERTS RADIO TECHNICAL SERVICES

97-99 Worton Road

Isleworth Middlesex

TW7 6EG

Technical Helpline :- 020 8758 0338 (Mon-Fri during office hours)

Website: <http://www.robertsradio.co.uk>

