

LM929

19" LCD Monitor

User's Manual

By Envision Peripherals, Inc.

www.aocmonitor.com

TABLE OF CONTENTS

Table of Contents	1
For Your Safety	2
Precautions	3
General Notes	4-5
Before You Operate The Monitor	6
Installation Instructions	7-13
Operating Instructions	14-19
Technical Support (FAQ)	19-21
Appendix	21-25

FOR YOUR SAFETY

Before operating the monitor, please read this manual thoroughly. This manual should be retained for future reference.

FCC Class B Radio Frequency Interference Statement WARNING: (FOR FCC CERTIFIED MODELS)

NOTE: This equipment has been tested and found to comply with the limits for a Class B digital device, pursuant to Part 15 of the FCC Rules. These limits are designed to provide reasonable protection against harmful interference in a residential installation. This equipment generates, uses and can radiate radio frequency energy, and if not installed and used in accordance with the instructions, may cause harmful interference to radio communications. However, there is no guarantee that interference will not occur in a particular installation. If this equipment does cause harmful interference to radio or television reception, which can be determined by turning the equipment off and on, the user is encouraged to try to correct the interference by one or more of the following measures:

1. Reorient or relocate the receiving antenna.
2. Increase the separation between the equipment and receiver.
3. Connect the equipment into an outlet on a circuit different from that to which the receiver is connected.
4. Consult the dealer or an experienced radio/TV technician for help.

NOTICE:

1. The changes or modifications not expressly approved by the party responsible for compliance could void the user's authority to operate the equipment.
2. Shielded interface cables and AC power cord, if any, must be used in order to comply with the emission limits.
3. The manufacturer is not responsible for any radio or TV interference caused by unauthorized modification to this equipment. It is the responsibilities of the user to correct such interference.

As an ENERGY STAR® Partner Envision Peripherals Inc. has determined that this product meets the ENERGY STAR® guidelines for energy efficiency.

WARNING:

To prevent fire or shock hazard, do not expose the monitor to rain or moisture. Dangerously high voltages are present inside the monitor. Do not open the cabinet. Refer servicing to qualified personnel only.

SAFETY: Lamp Disposal

 LAMP(S) INSIDE THIS PRODUCT CONTAIN MERCURY AND MUST BE RECYCLED OR DISPOSED OF ACCORDING TO LOCAL, STATE OR FEDERAL LAWS. FOR MORE INFORMATION, CONTACT THE ELECTRONIC INDUSTRIES ALLIANCE AT WWW.EIAE.ORG

PRECAUTIONS

- Do not use the monitor near water, e.g. near a bathtub, washbowl, kitchen sink, laundry tub, swimming pool or in a wet basement.
- Do not place the monitor on an unstable cart, stand, or table. If the monitor falls, it can injure a person and cause serious damage to the appliance. Use only a cart or stand recommended by the manufacturer or sold with the monitor. If you mount the monitor on a wall or shelf, use a mounting kit approved by the manufacturer and follow the kit instructions.
- Slots and openings in the back and bottom of the cabinet are provided for ventilation. To ensure reliable operation of the monitor and to protect it from overheating, be sure these openings are not blocked or covered. Do not place the monitor on a bed, sofa, rug, or similar surface. Do not place the monitor near or over a radiator or heat register. Do not place the monitor in a bookcase or cabinet unless proper ventilation is provided.
- Do not install the monitor in a location near heat sources such as radiators or air ducts, or in a place subject to direct sunlight, or excessive dust or mechanical vibration or shock.
- The monitor should be operated only from the type of power source indicated on the label. If you are not sure of the type of power supplied to your home, consult your dealer or local power company.
- The monitor is equipped with a three-pronged grounded plug, a plug with a third (grounding) pin. This plug will fit only into a grounded power outlet as a safety feature. If your outlet does not accommodate the three-wire plug, have an electrician install the correct outlet or ground the appliance safely. Do not defeat the safety purpose of the grounded plug.
- Unplug the unit during a lightning storm or when it will not be used for long period of time. This will protect the monitor from damage due to power surges.
- Do not overload power strips and extension cords. Overloading can result in fire or electric shock.
- Never push any object into the slot on the monitor cabinet. It could short circuit parts causing a fire or electric shock. Never spill liquids on the monitor.
- Do not attempt to service the monitor by yourself. Opening or removing covers can expose you to dangerous voltages and other hazards. Please refer all servicing to qualified service personnel.
- To ensure satisfactory operation, use the monitor only with UL listed computers which have appropriate configured receptacles marked between 100 - 240V AC, Min. 5A.
- The wall socket shall be installed near the equipment and shall be easily accessible.

GENERAL NOTES

SPECIAL NOTES ON LCD MONITORS

The following symptoms are normal with LCD monitor and do not indicate a problem.

- Due to the nature of the fluorescent light, the screen may flicker during initial use. Turn off the Power Switch and then turn it on again to make sure the flicker disappears.
- You may find slightly uneven brightness on the screen depending on the desktop pattern you use.
- The LCD panel used in this monitor is a very high technology product with 3,932,160 thin film transistors giving you fine picture details. Occasionally, a few non-active pixels may appear on the screen as a fixed point of red, green, blue, white or black. Please note that this does not indicate a defective panel.
- Due to the nature of the LCD screen, an after-image of the previous screen may remain after switching the image when the same image has been displayed for a long time. The monitor will slowly recover from this.
- LCD monitors have a fixed size & number of pixels. Due to this, an interpolation is necessary to operate the monitor in a relation below its native resolution which may slightly degrade the display quality. Therefore, it is highly recommended to operate the monitor at its native resolution of 1280 x 1024 @ 60Hz.

OTHER NOTES

- The screen surface is very soft. Do not rub, touch or tap the screen surface with sharp object such as pen or pencil. This contact may scratch or damage the screen. These damages are not covered under the warranty.
- Turn your computer OFF before installing your new monitor. Refer to your computer manual for the proper shut down procedure.
- Save the original shipping carton and packing materials, as they will come in handy if you ever have to ship your monitor.
- For maximum protection, repackage your monitor as it was originally packed at the factory.
- To keep the monitor looking new, periodically clean the case & surface of the TFT-LCD panel with a soft non-fibrous cloth lightly dampened with a glass cleaner. Do not use any paper products to clean the screen. Never spray the glass cleaner directly on the monitor. Never use strong solvents such as thinner, benzene, or abrasive cleaners, since these will damage the case & panel. As a safety precaution, always unplug the monitor before cleaning it.

GENERAL NOTES (cont)

- Plug & Play DDC 2B Feature - This monitor is equipped with VESA DDC 2B capabilities according to the VESA DDC STANDARD. It allows the monitor to inform the host system of its identity and, depending on the level of DDC used, communicate additional information about its display capabilities.

The DDC 2B is a bidirectional data channel based on the I²C protocol. The host can request EDID information over the DDC 2B channel.

- This monitor will appear to be non-functional if there is not video input signal. In order for this monitor to operate properly, there must be a video input signal.

BEFORE YOU OPERATE THE MONITOR

FEATURES

- 19" (48cm) TFT Color LCD Monitor
- Crisp & Clear Display for Windows
- Recommended Resolutions: 1280 X 1024 @ 60Hz
- EPA ENERGY STAR[®]
- 3W + 3W Stereo Speakers
- Ergonomic Design with Height, Pivot, Tilt & Swivel Adjustable Stand
- Space Saving, Compact Case Design

CHECKING THE CONTENTS OF THE PACKAGE

The product package should include the following items:

		
Monitor	Base	Quick Start Guide (QSG)
		
Warranty Booklet	CD (Manual & Drivers)	15-pin D-Sub Cable
		
24-Pin DVI Cable	Power Cord	PC Stereo Cable

INSTALLATION INSTRUCTIONS

INSTALLING & REMOVING THE BASE

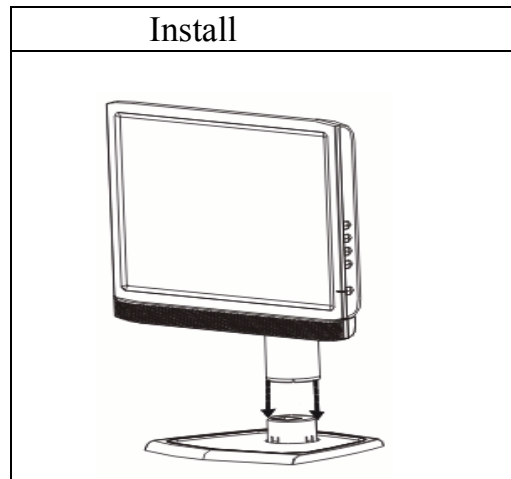

Figure 1 - Installing the Base.

INSTALLING THE BASE

1. Set the bottom base on a flat surface.
2. Line up the front of the monitor with the front of the base and press firmly.

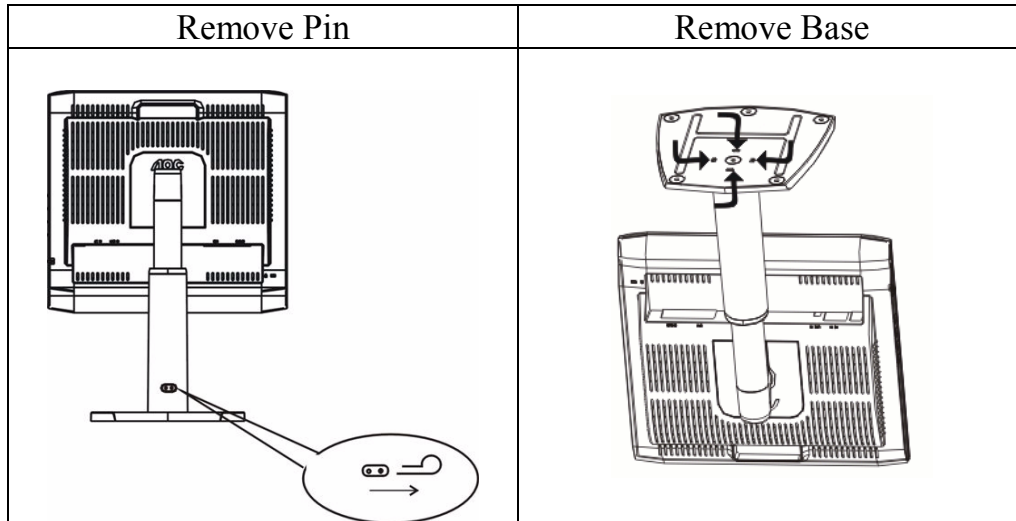

Figure 2 - Installing the Base.

REMOVING THE BASE

1. Never remove the base while the height adjustment lock pin is installed. Set the monitor standing on a flat firm surface. Remove the height adjustment lock pin.
2. Set the monitor face down on a padded flat surface. Press the four clips inward while pushing the bottom base out.

INSTALLATION INSTRUCTIONS (Cont)

POWER CORD

Power Source:

1. Make sure that the power cord is the correct type required in your area.
2. This LCD monitor has an internal Universal Power Supply that allows operation in either 100/120V AC or 220/240V AC voltage area (No user adjustment is required.)
3. Connect the AC-power cord into your LCD monitor's AC-power-input. The AC-power cord may be connected to either a wall power outlet or the power outlet socket on your PC, depending on the type of power cord supplied with your LCD monitor.

A certified power supply cord has to be used with this equipment. The relevant national installation and/or equipment regulations shall be considered. A certified power supply cord not lighter than ordinary polyvinyl chloride flexible cord according to IEC 60227 (designation H05VV-F 3G 0.75mm² or H05VVH2-F2 3G 0.75mm²) shall be used. As an alternate, a flexible cord of synthetic rubber according to IEC 60245 (designation H05RR-F 3G 0.75mm²) shall be used.

The accessory power cord for the Northern American region is the wall plug with NEMA 5-15 style and is UL listed and CSA labeled. The voltage rating for the power cord shall be 125 volts AC.

Supplied with units intended for connection to power outlet of personal computer: Please use a cord set consisting of a minimum No. 18 AWG, type SJT or SVT three conductors flexible cord. One end terminates with a grounding type attachment plug, rated 10A, 250V, CEE-22 male configuration. The other end terminates with a molded-on type connector body, rated 10A, 250V, having standard CEE-22 female configuration.

Please note that power supply cord needs to use VDE 0602, 0625, 0821 approval power cord in European counties.

INSTALLATION INSTRUCTIONS (Cont)

Connecting The Cables

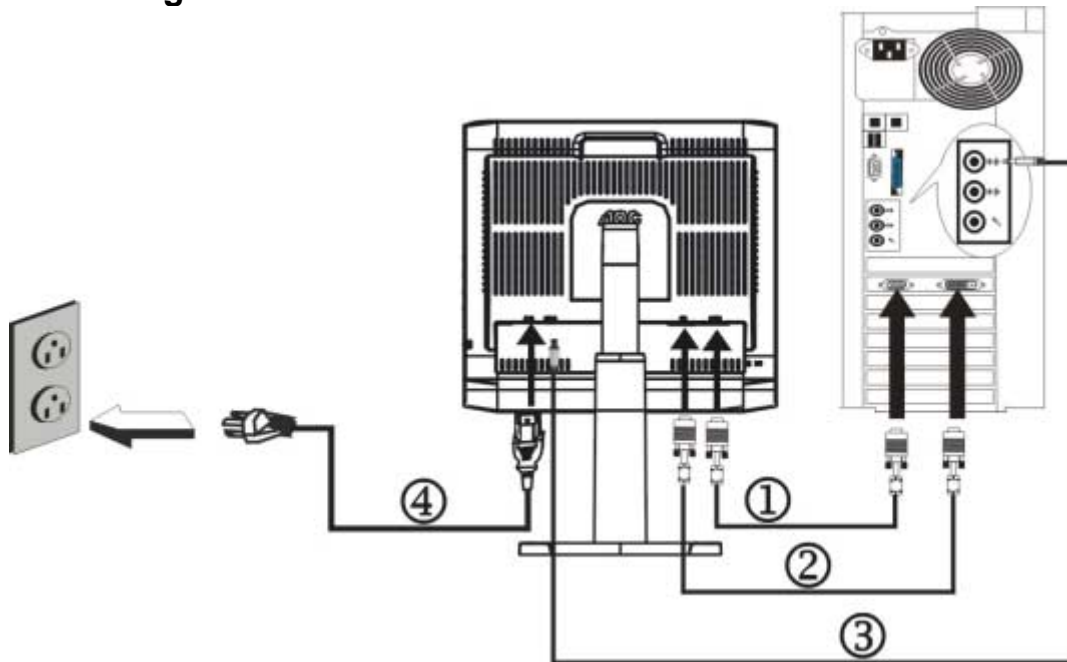

Figure 2 Connecting Cables

1.	15-pin D-SUB Cable	2.	24-Pin DVI Cable
3.	Audio Cable	4.	AC Power Cord

Turn off your computer before performing the procedure below.

1. Connect one end of the 15-pin D-Sub cable to the back of the monitor and connect the other end to the computer's D-Sub port.
2. (Optional – Requires a video card with DVI port) Connect one end of the 24-pin DVI cable to the back of the monitor and connect the other end to the computer's DVI port. be tightened.
3. (Optional) - Connect the PC stereo cable between the monitor's audio input and the PC's green audio output port.
4. Connect the female end of the AC power cord to the AC-in port on the back of the monitor. Connect the other end to a nearby AC-outlet.
5. Turn on your monitor and computer. If you monitor diplays an image, installation is complete. If not, refer to the FAQ (frequently asked questions) section for troubleshooting.

INSTALLATION INSTRUCTIONS (cont)

How To Install The INF & ICM Files

- This is a Plug & Play monitor. Microsoft Windows will automatically install a Plug & Play driver for it when you first install this monitor. It is not necessary to install the INF driver file included in the floppy diskette or CD if Microsoft Windows successfully installed a Plug & Play driver. If you would still like to install the driver included in the floppy diskette or CD that came with the monitor, log-on to our website at <http://www.envisionmonitor.com/support/faq.asp>. Then look for “Installing the Driver” section.

INSTALLATION INSTRUCTIONS (cont)

Height, Tilt, Pivot & Swivel Adjustment

Your monitor features a multi-adjustable stand that will enable it move 110mm up/down (height adjustment), 25 degree forward/backward (tilt adjustment), 90 degree landscape/portrait (pivot adjustment) and 70 degree side/side (swivel adjustment). To make an adjustment, grasp the monitor with both hands on the right and left edge of the casing and move it to the desired position.

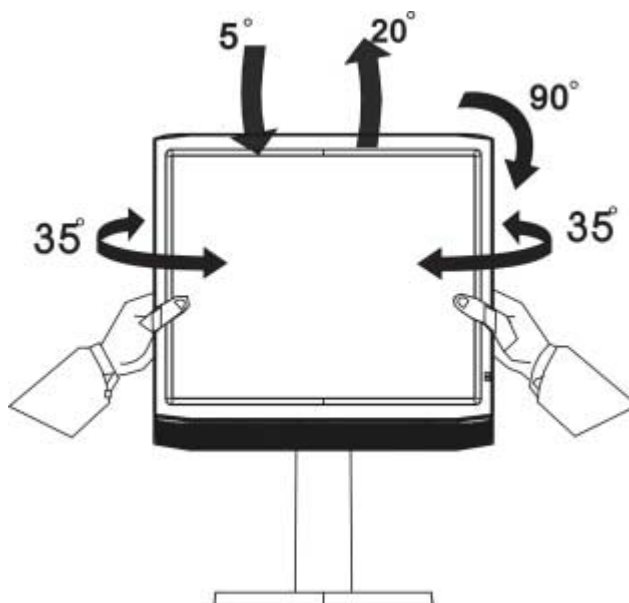
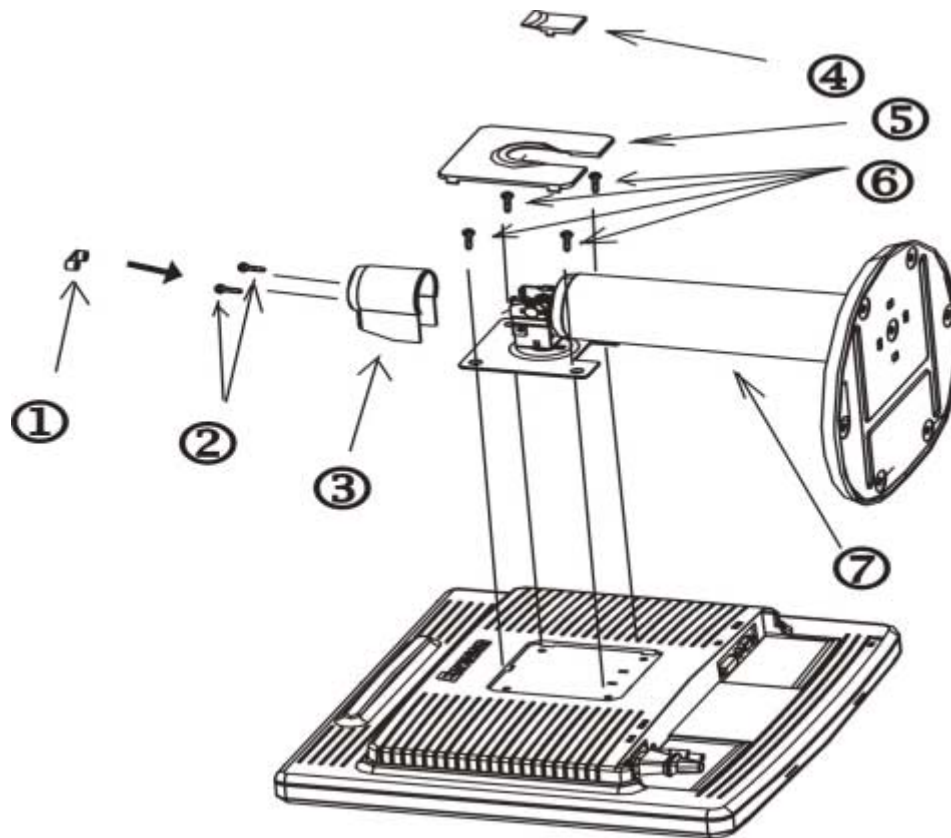

Figure 3

NOTES

- Do not touch the LCD screen when making the adjustments above. It may cause damage or break the LCD screen.
- Do not touch the speaker module when making the adjustments above. It may cause damage to the speaker module.
- Careful attention is required not to catch your fingers or hands when making the adjustments above.
- In order to use the Pivot function, the included Pivot Software must be installed. Run `D:\PIVOT\START_PIVOT.EXE`, where D is the driver letter for your CD ROM Drive.

INSTALLATION INSTRUCTIONS (cont)**Preparing To Install The Optional Wall Mount Arm (Not Included)**

This monitor can be attached to a wall mounting arm you can purchase separately. Turn the power OFF then dis-connect the cables from the monitor before performing the procedure below. Lay the monitor face down on a soft surface.

1. Remove the two rubber screw covers.
2. Remove the 2 screws that hold the plastic hinge cover.
3. Remove the plastic hinge cover.
4. Remove the small plastic cover. It is attached to the back of the monitor by hooks.
5. Remove the large plastic cover. It is attached to the back of the monitor by hooks.
6. Remove the 4 screws holding the stand to the back of the monitor.
7. Remove the stand.

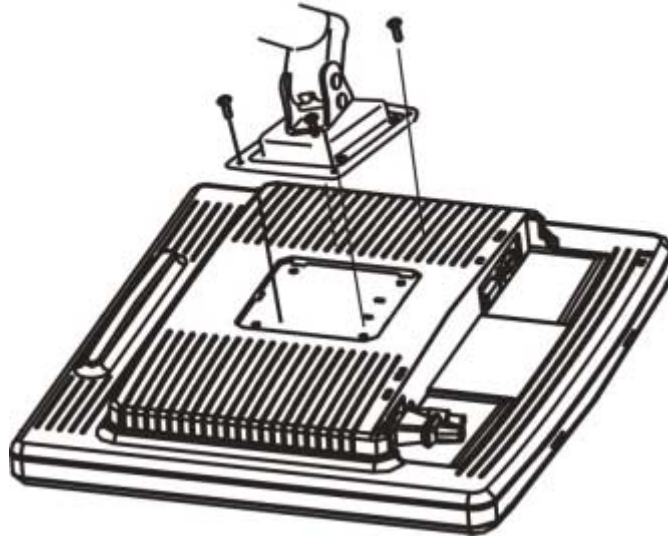
INSTALLATION INSTRUCTIONS (cont)**Attaching The Optional Wall Mount Arm (not supplied)**

Follow these steps to finish installing the wall mounting arm:

1. Place the wall mounting arm onto the back of the monitor. Line up the holes of the arm with the holes in the back of the monitor.
2. Insert the 4 screws into the holes and tighten.
3. Reconnect the cables. Refer to the user's manual that came with the optional wall mounting arm for instructions on attaching it to the wall.

NOTE

The Envision LM929 is in compliance with the most current revision of the VESA 75mm Flat Panel Monitor Physical Mounting Interface (FPMPMI standard). Visit our Monitor Accessories website at www.aocmonitor.com/accessories.html to purchase a wall mount solution suitable for your needs.

OPERATING INSTRUCTIONS

EXTERNAL CONTROLS

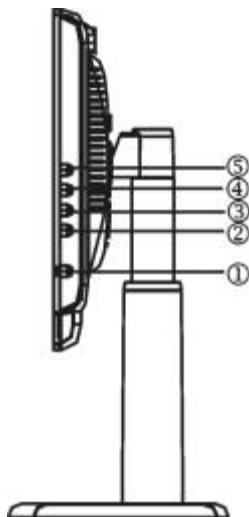

Figure 4 - External Controls

EXTERNAL CONTROLS

1. Power Button	4. < or Volume Button
2. MENU or ENTER Button	5. Auto Adjust or Exit Button
3. > or Volume Button	

- **Power Button:**
Press this button to turn the monitor ON or OFF.
- **MENU / ENTER:**
This button will activate the OSD menu when OSD is OFF or activate/de-activate an adjustment function when OSD is ON or Exit OSD menu when in Volume Adjust OSD status.
- **</Volume:**
This button will activate the volume control when the OSD is OFF or navigate through adjustment icons when OSD is ON or adjust a function when function is activated.
- **>/Volume:**
This button will activate the volume control when the OSD is OFF or navigate through adjustment icons when OSD is ON or adjust a function when function is activated.

OPERATING INSTRUCTIONS (cont)

- **Auto Adjust button / Exit:**

1. When OSD menu is in active status, this button will act as EXIT-KEY (EXIT OSD menu) or go back to the previous menu.
2. When OSD menu is in off status, press this button for 2 seconds to activate the Auto Adjustment function.
The Auto Adjustment function is used to set the HPos, VPos, Clock and Focus.

- **Power Indicator:**

Green — Power On mode.
Orange — Off mode.

- **Osd-Lock Function:**

To lock the OSD, press and hold the MENU button while the monitor is off and then press power button to turn the monitor on.

To un-lock the OSD - press and hold the MENU button while the monitor is off and then press power button to turn the monitor on.

OPERATING INSTRUCTIONS (cont)

How To Adjust A Setting











1. Press the MENU-button to activate the OSD window (Figure 4).
2. Press < or > to navigate through the functions. Once the desired function is highlighted, press the MENU-button to activate it. If the function selected has a sub-menu, press < or > again to navigate through the sub-menu functions. Once the desired function is highlighted, press MENU-button to activate it.
3. Press < or > to change the settings of the selected function.
4. To exit and save, select the exit function. If you want to adjust any other function, repeat steps 2-3.











Figure 4 The OSD Message

OPERATING INSTRUCTIONS (cont)

The descriptions for function control LEDS

Main Menu Item	Main Menu Icon	Sub Menu Item	Sub Menu Icon	Description	Reset Value
Lumina nce		Contrast		Contrast from Digital-register.	Recall Cool Contrast Value
		Brightness		Backlight Adjustment	Recall Cool Brightness Value
Image Setup		Focus		Adjust Picture Phase to reduce Horizontal-Line noise	Do Auto Config
		Clock		Adjust picture Clock to reduce Vertical-Line noise.	Do Auto Config
Image Position		H. Position		Adjust the horizontal position of the picture.	Do Auto Config
		V. Position		Adjust the verticalposition of the picture.	Do Auto Config
Color Temp.		Warm	N/A	Recall Warm Color Temperature from EEPROM.	The Color Temperature will be set to Cool.
		Cool	N/A	Recall Cool Color Temperature from EEPROM.	The User R/G/B value(default is 100) will not be Modified by Reset function.
		User / Red	R	Red Gain from Digital-register.	
		User / Green	G	Green Gain Digital-register.	
		User / Blue	B	Blue Gain from Digital-register.	
Input Select		Analog	N/A	Select input signal from analog source (D-Sub)	

		Digital	N/A	Select input signal from digital source (DVI)	
OSD Setup		H. Position		Adjust the horizontal position of the OSD.	50
		V. Position		Adjust the vertical position of the OSD.	50
		OSD Timeout		Adjust the OSD timeout.	10
Language		English	N/A	Set OSD display language to English.	The Language will be set to English.
		Deutsch	N/A	Set OSD display language to German.	
		Français	N/A	Set OSD display language to French.	
		Español	N/A	Set OSD display language to Spain.	
		Italiano	N/A	Set OSD display language to Italian.	
		简体中文	N/A	Set OSD display language to Simplified Chinese.	
Information		Information	N/A	Show the resolution, H/V frequency and input port of current input timing.	N/A

Reset		Yes	N/A	Clear each old status of Auto-configuration and set the color temperature to Cool.	N/A
		No	N/A	Do not execute reset, return to main menu.	N/A
Exit		N/A	N/A	Exit OSD	N/A

TECHNICAL SUPPORT (FAQ)

Problem & Question	Possible Solution
Power LED is not on	<ul style="list-style-type: none"> *Check if the Power Switch is in the ON position *Power Cord should be connected
No Plug & Play	<ul style="list-style-type: none"> *Check if the PC system is Plug & Play compatible *Check if the Video Card is Plug & Play compatible *Check if the D-15 plug pin of Video Cable is bent *Make sure the AOC Monitor Drivers are installed
Picture is fuzzy	<ul style="list-style-type: none"> *Adjust the Contrast and Brightness Controls.
Picture bounces or a wave pattern is present in the picture	<ul style="list-style-type: none"> *Move electrical devices that may cause electrical interference.
The power LED is ON (orange) but there's no video or no picture.	<ul style="list-style-type: none"> *Computer Power Switch should be in the ON position. *Computer Video Card should be snugly seated in its slot *Make sure monitor's video cable is properly connected to the computer. *Inspect monitor's video cable and make sure none of the pins are bent. *Make sure computer is operational by hitting the CAPS LOCK key on the keyboard while observing the CAPS LOCK LED. The LED should either turn ON or OFF after hitting the CAPS LOCK key.
Missing one of the primary colors (RED, GREEN, or BLUE)	<ul style="list-style-type: none"> *Inspect the monitor's video cable and make sure that none of the pins are bent.
Screen image is not centered or sized properly.	<ul style="list-style-type: none"> *Adjust pixel frequency (CLOCK) and FOCUS or press hot-key (AUTO)
Picture has color defects (white does not look white)	<ul style="list-style-type: none"> *Adjust RGB color or select color temperature
Horizontal or vertical disturbances on the screen	<ul style="list-style-type: none"> *Use win 95/98 shut-down mode Adjust CLOCK and FOCUS or perform hot-key (AUTO-key).

TECHNICAL SUPPORT (FAQ) (cont)

CLOCK (pixel frequency) controls the number of pixels scanned by one horizontal sweep. If the frequency is not correct, the screen shows vertical stripes and the picture has not correct width.

FOCUS adjusts the phase of the pixel clock signal. With a wrong phase adjustment the picture has horizontal disturbances in light picture.

For FOCUS and CLOCK adjustment use “dot-pattern” or win 95/98 shut-down mode pattern.

ERROR MESSAGE & POSSIBLE SOLUTION

CABLE NOT CONNECTED :

1. Check that the signal-cable is properly connected , If the connector is loose, tighten the connector’s screws.
2. Check the signal -cable connection pins for damage.

INPUT NOT SUPPORT :

Your computer has been set to unsuitable display mode. Set the computer to a display mode given in the Preset Display Modes table.

APPENDIX

SPECIFICATIONS

LCD Panel	Driving system	TFT Color LCD
	Size	48cm(19.0")
	Pixel pitch	0.294mm(H)x 0.294mm(V)
	Viewable angle	140° (H) 140° (V)
Input	Video	R,G,B Analog Interface
		Digital interface
	Separate Sync.	H/V TTL
	H-Frequency	24KHz – 83KHz
	V-Frequency	55-75Hz
Display Colors		16.7M Colors
Dot Clock		135MHz
Max. Resolution		1280 x 1024 @75Hz
Plug & Play		VESA DDC 2B™
EPA ENERGY STAR®	ON Mode	≤60W
	OFF Mode	≤2W
Input Connector		D-Sub 15pin
		DVI-D 24pin
Input Video Signal		Analog:0.7Vp-p(standard), 75 OHM, Positive
		Digital DVI-D
Maximum Screen Size		Horizontal : 376.32mm Vertical : 301.056mm
Power Source		100~240VAC,50/60HZ
Environmental Considerations		Operating Temp: 0° to 40°C Storage Temp.: -20° to 60°C Operating Humidity: 15% to 90%
Dimensions		438(W)x441.5-551.5(H)x243(D)mm
Weight (N. W.)		7.8kg Unit (net)

APPENDIX (cont)

External Controls:	Switch	<ul style="list-style-type: none"> • Auto Adjust Key/Exit • </Volume • >/ Volume • Power Button • MENU/ Enter
	Functions	<ul style="list-style-type: none"> • Contrast • Brightness • Focus • Clock • H.Position • V.Position • Language • Input Select (Analog/DVI) • (Warm) Color • (Cool)Color • RGB Color temperature • OSD position, OSD timeout • Display input information • Reset • Exit
Power Consumption	(Maximum)	55 Watts
Speakers		3W + 3W
Regulatory Compliance		UL, FCC, CSA, TÜV/GS, CE, ISO13406-2 Class II

APPENDIX (cont)
Preset Display Modes

STANDARD		RESOLUTION	HORIZONTAL FREQUENCY(KHZ)	VERTICAL FREQUENCY(HZ)
VESA	VGA	640 × 480	31.469	59.940
		640 × 480	37.500	75.000
	SVGA	800 × 600	37.879	60.317
		800 × 600	46.875	75.000
	XGA	1024 × 768	48.363	60.004
		1024 × 768	56.476	70.069
		1024 × 768	60.023	75.029
	SXGA	1280 × 1024	64.00	60.000
1280 × 1024		80.00	75.000	
IBM	DOS	720 × 400	31.469	70.087
MAC	XGA	1024 × 768	48.780	60.001
		1024 × 768	60.241	74.927

APPENDIX (cont)

Connector Pin Assignment

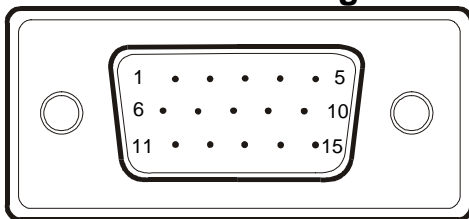

15 - Pin Color Display Signal Cable

PIN NO.	DESCRIPTION	PIN NO.	DESCRIPTION
1.	Red	9.	NC
2.	Green	10.	Logic Ground
3.	Blue	11.	Monitor Ground
4.	Monitor Ground	12.	DDC-Serial Data
5.	DDC-return	13.	H-Sync
6.	R-Ground	14.	V-Sync
7.	G-Ground	15.	DDC-Serial Clock
8.	B-Ground		

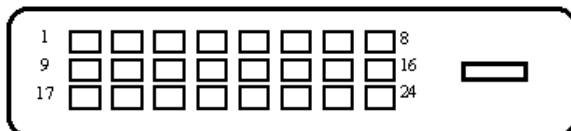

24 - Pin Color Display Signal Cable

PIN NO.	DESCRIPTION	PIN NO.	DESCRIPTION
1.	TMDS Data 2-	13.	TMDS Data 3+
2.	TMDS Data 2+	14.	+5V Power
3.	TMDS Data 2/4 Shield	15.	Ground(for+5V)
4.	TMDS Data 4-	16.	Hot Plug Detect
5.	TMDS Data 4+	17.	TMDS Data 0-
6.	DDC Clock	18.	TMDS Data 0+
7.	DDC Data	19.	TMDS Data 0/5 Shield
8.	Analog vertical sync	20.	TMDS Data 5-
9.	TMDS Data 1-	21.	TMDS Data 5+
10.	TMDS Data 1+	22.	TMDS Clock Shield
11.	TMDS Data 1/3 Shield	23.	TMDS Clock +
12.	TMDS Data 3-	24.	TMDS Clock -