

INSTRUCTION MANUAL

SENTINEL CCTV

4 CHANNEL DVR

SC324 Series



FOR MORE INFORMATION
WWW.SENTINELCCTV.COM

**BEFORE OPERATING THIS SYSTEM, PLEASE READ THIS MANUAL THOROUGHLY
AND RETAIN IT FOR FUTURE REFERENCE**

Thank you for purchasing the 4 channel DVR from Strategic Vista.

The DVR converts analog video into digital format and records them on a hard disk drive depending on the system purchased. Digital video allows you to quickly access and search for a specific time segment or event which has been recorded. The DVR supports one HDD unit, 40 Pin IDE Type, with a maximum capacity of 250 GB

To learn more about this system or to find out more about our products available, please visit our website at:

www.sentinelcctv.com

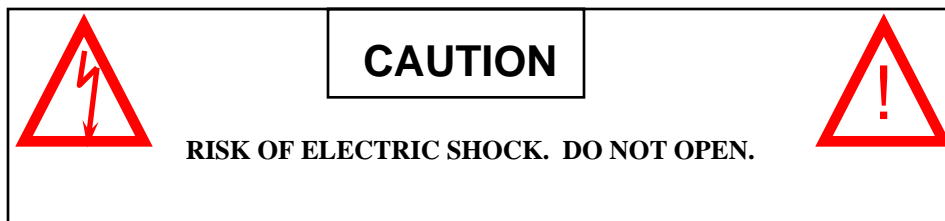

CAUTION! TO REDUCE THE RISK OF ELECTRIC SHOCK, DO NOT REMOVE COVER (OR BACK). NO USER-SERVICEABLE PARTS INSIDE. REFER SERVICING TO QUALIFIED SERVICE PERSONNEL.

Explanation of two Symbols



The lightning flash with arrowhead symbol, within an equilateral triangle, is intended to alert the user to the presence of un-insulated "dangerous voltage" within the product's enclosure that may be of sufficient magnitude to constitute a risk of electric shock to persons.



The exclamation point within an equilateral triangle is intended to alert the user to the presence of important operating and maintenance (servicing) instructions in the literature accompanying the appliance.

THE GRAPHIC SYMBOLS WITH SUPPLEMENTAL MARKING ARE ON THE BOTTOM OF THE SYSTEM.

“WARNING – TO PREVENT FIRE OR SHOCK HAZARD, DO NOT EXPOSE THE UNIT TO RAIN OR MOISTURE”

NOTE

This equipment has been certified and found to comply with the limits regulated by FCC, EMC and LVD. Therefore, it is designed to provide reasonable protection against interference and will not cause interference with other appliance usage. However, it is imperative that user follows this manual's guidelines to avoid improper usage which may result in damage to the unit, electrical shock and fire hazard or injury.

In order to improve the feature functions and quality of this product, the specifications are subject to change without notice from time to time.

FCC CLASS B NOTICE

Note:

This equipment has been tested and found to comply with the limits For a Class B digital device, pursuant to Part 15 of the FCC Rules. These limits are designed to provide reasonable protection against harmful interference in a residential installation. This equipment generates, uses and can radiate radio frequency energy and, if not installed and used in accordance with the instruction, may cause harmful interference to radio communications. However, there is no guarantee that interference will not occur in a particular installation. If this equipment does cause harmful interference to radio or television reception, (which can be determined by turning the equipment off and on), the user is encouraged to try to correct the interference by one or more of the following measures:

- Increase the separation between the equipment and the camera and/or monitor.
- Connect the equipment into an outlet on a circuit different from that to which the monitor is connected.
- Consult the dealer or an experienced radio or television technician for help.

STRATEGIC VISTA CORP.

www.sentinelcctv.com

CONTENTS: _____

GENERAL PRECAUTIONS	1
FEATURES	2
SYSTEM CONTENTS	3
GETTING STARTED	3
CONTROLS - FRONT PANEL	4
BACK PANEL	6
MAIN MENU CONTROL.....	7
OPERATION	
CAMERA SELECT (1-4)	18
RECORDING	18
PLAYBACK	19
SEARCH	20
VIDEO LOSS.....	20
KEY LOCK	20
TROUBLESHOOTING	21
TECHNICAL SPECIFICATIONS	22
APPENDIX # 1 – INSTALLING THE HDD.....	23
APPENDIX #2 – TYPICAL CONFIGURATION FOR A COMPLETE SYSTEM	24
APPENDIX #3 - CONNECTING PIR'S TO THE DVR.....	25
APPENDIX #4 – PIN CONFIGURATIONS FOR CONNECTION TO A COMPUTER	26
APPENDIX #5 – LIST OF COMPATIBLE HARD DISK DRIVES.....	28
APPENDIX #6 – RS 232 REMOTE PROTOCOL.....	29
APPENDIX #7 – RECORDING TIME (IN HOURS)	30
APPENDIX #8 – NETWORK APPLICATION (OPTIONAL).....	31
CARE & MAINTENANCE.....	33

GENERAL PRECAUTIONS:

1. **Read Instructions**
All of the safety and operating instructions should be read and understood before the product is used.
2. **Retain Instructions**
The safety and operating instructions should be retained for future reference.
3. **Heed Warnings**
All warnings on the product and the instruction manual should be followed.
4. **Follow Instructions**
All operating and use instructions should be followed for optimal performance
5. **Cleaning**
Disconnect this video product from the power supply before cleaning. Do not use liquid cleaners or aerosol cleaners. Use a damp cloth for cleaning.
6. **Attachments**
Do not use attachments not recommended by the video product manufacturer as they may cause hazards.
7. **Water and Moisture**
Do not use this product near water - for example, near a bathtub, wash bowl, kitchen sink, wet basement, or near a swimming pool.
8. **Accessories**
Use this product only with a stand, tripod, bracket or table recommended by the manufacturer or sold with the product. Any mounting of the product should follow the manufacturer's instructions.
9. **Ventilation**
This product should never be placed near or over a radiator or heat register. This product should not be placed in a built-in installation, such as a book case or rack, unless proper ventilation is provided or the Manufacturer's instructions have been adhered to.
10. **Power Source**
This product should be operated from the type of Power source indicated by the marking label. If you are not sure of the type of power supply to your location, consult your product dealer or your local Power company
11. **Power Cord Protection**
Power supply cords should not be routed so that they are likely to be walked on or pinched by items placed on or near them
12. **Lightning**
For added protection, unplug this product from its outlet during a lightning storm. This will prevent damage to the video product due to lightning and power surges
13. **Overloading**
To avoid the risk of fire and electric shock, do not plug this product into an over-loaded power supply.
14. **Object and Liquid Entry**
Never push objects into the openings of this product as they may touch dangerous voltage points that may result in fire or electric shock. Never spill a liquid of any kind on this product.
15. **Servicing**
Do not attempt to service this product yourself as opening or removing covers may expose you to voltage or other hazards. Refer all servicing to qualified service personnel
16. **Damage Requiring Service**
Disconnect this product from the power supply and refer servicing to qualified service personnel under the following conditions:
 - a. When the power supply cord or plug is damaged
 - b. If objects have fallen into the product
 - c. If the product has been exposed to rain or liquids
 - d. If the product does not operate normally by following the instruction manual. Adjust only the controls that are covered in the instruction manual as an improper adjustment may result in damage and will often require extensive work by a qualified service technician to restore the product to its normal operation
 - e. If the product has been dropped or the cabinet has been damaged
 - f. When the product displays a distinct change in performance - this indicates a need for service
17. **Replacement Parts**
When replacement parts are required, be sure the technician uses replacement parts specified by the manufacturer. Unauthorized substitutions may result in fire, electric shock, or other hazards.
18. **Safety Check**
Upon completion of any service to this product ask the service technician to perform safety checks to determine that the product is in proper working condition.
19. **Grounding or Polarization**
This product is equipped with a three-wire grounding-type plug, a plug having a third (grounding) pin and will only fit into a grounding-type power outlet. This is a safety feature. If you are unable to insert the plug into the outlet, contact your electrician to replace your obsolete outlet. Do not defeat the safety purpose of the grounding-type plug.
20. **Power Lines**
An outside antenna system should not be located in the vicinity of overhead power lines or other electric light or power circuits, or where it can fall into such power lines or circuits. When installing an outside antenna system, extreme care should be taken to keep from touching such power lines or circuits as contact with them might be fatal.
21. **Wall or Ceiling Mounting**
The product should be mounted to a wall or ceiling only as recommended by the manufacturer.
22. **Heat**
The product should be situated away from heat such as radiators, heat registers, stoves, or other products (including amplifiers) that produce heat.

CAUTIONS: _____

1. All the warnings and instructions of this manual should be followed
2. Remove the plug from the outlet before cleaning. Do not use liquid aerosol detergents. Use water damped cloth for cleaning
3. Do not use this unit in very humid and wet places
4. Keep enough space around the unit for ventilation. Slots and openings of the cabinet should not be blocked.
5. During flashes of lightning or cracks of thunder, or when the system is not used for a long time, unplug the system power supply and disconnect the antenna and cables to protect the unit from lightening or power surges.
6. Do not try to retrieve the HDD data by PC.

DVR Features

- Wavelet compression format
- 4 Channel DVR replaces Time-Lapse VCR + Multiplexer / Quad
- Linear Zoom (2x~4x)
- On Screen Display and Remote Control via Video Server & PC (Video Server sold separately)
- Picture-in-picture (PIP) and Picture-on-Picture (POP) viewing modes
- Motion detection triggered record function
- Alarm input & output function
- Video loss detected on each channel. Alarm history stores & records up to 256 events
- Multiplexer or Quad recording mode selectable
- Recording rate of up to 30 IPS in the Multiplexer Mode and 120 IPS in the Quad Mode
- Supports up to a 250 GB HDD
- Quick search by date/time and alarm
- Security password protection
- RS-232, RS-485 communication protocol

SYSTEM INCLUDES:



4 CHANNEL DVR



**OWNER'S
MANUAL**



**An 80 GB or 120GB
HDD may be included
depending on the DVR
purchased**



**Accessories pack,
including the external
alarm block**



**Power Adapter & Cord
(DC 19V, 2A)**

CHECK YOUR PACKAGE TO MAKE SURE THAT YOU RECEIVED THE COMPLETE SYSTEM, INCLUDING THE COMPONENTS SHOWN ABOVE.

GETTING STARTED:

1. Connect the AC power cord and plug it into an electrical outlet. The POWER LED will illuminate orange. Other LED indicators will turn ON and illuminate RED. It takes approximately 5 to 15 seconds to boot the system with the message : " HDD Detecting ". Once successfully connected, the POWER LED will change to a green color, and the Alarm LED will be ON.
2. Before operating the DVR, set the systems "time" first. (refer to page.16).

- NOTE :**
1. If the HDD is not installed correctly or not installed, the "HDD not found" message will appear for 3 seconds and then return to a 4 CH Multiplexer display mode.
 2. If the keys on the DVR are locked, the default password is "0000" to disable the key lock.
 3. To switch the system (back to DVR Function), pull out the AC power cord. Before you reconnect the power, press "FF" for the NTSC system or "REW" for the PAL system. Note: North America is on an NTSC system, while European countries use PAL. Reconnect the AC power cord, and the DVR will auto-detect the change.

CONTROL - FRONT PANEL:

The diagram below shows the front right-side panel

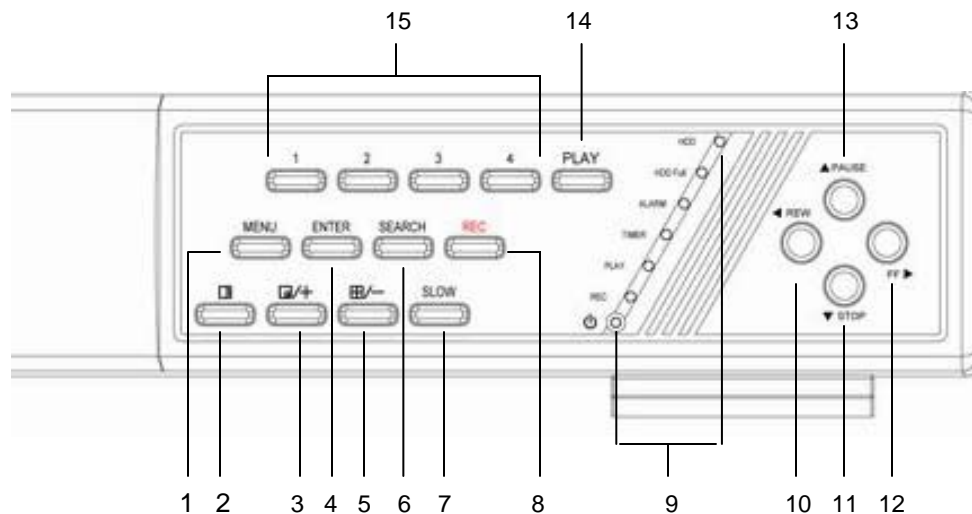

1. **Menu**

Press the **MENU** to enter the main menu. Please refer to page 7 for more information on the Menu options.

2. / **POP**

When viewing a single screen or Quad Screen, press the “  ” button for Picture on Picture screen.

3. /+ **Picture in Picture**

This button performs two functions:

- 1) During normal operation press the “PIP” button to open this window.
- 2) When in the Menu mode, press the “+” button to change a selected item.

4. **Enter** – In the Menu mode, pressing this button selects a submenu option to be entered.

5. /- **4-channel display mode**

This button performs two functions:

- 1) During normal operation press the “  ” button to display a quad screen.
- 2) When in the Menu mode, press the “-” button to change a selected item.

6. **SEARCH**

Pressing this button brings up the Search menu, which allows you to quickly find recordings. You can select recordings from a list, or search by Time/Date event. For more information on Search options, please refer to page 20.

7. **SLOW**

Press to slow down the playing mode speed. Please refer to page 19 (Playback).

8. **REC** – Initiates manual recording.

9. LED indicators – Represents the status of operation.

- (1) HDD** : Blinks when the HDD is being accessed (via recording or playback).
- (2) HDD FULL** : If the OVERWRITE menu is set up, the LED does not blink. This LED will blink if the HDD has less than 1GB of storage space remaining, and remains ON when HDD is FULL.
- (3) ALARM** : LED will be ON when the ALARM or MOTION functions are enabled. When an ALARM or MOTION event is detected, the LED will blink for the duration. To turn off the ALARM LED light, please refer to page 10 and set the ALARM mode as OFF.
- (4) TIMER** : This LED comes ON when the timer record function is enabled. This is performed in the “Timer” section of the setup menu.
- (5) PLAY** : This LED comes ON when video playback is in progress.
- (6) REC** : This LED comes ON when recording is in progress.

10. REW / ◀ - This button performs two functions:

- 1) REW : During playback, press this button to rewind the video (Press REW button again to adjust speed as 1, 2, 4, 8, 16, 32 times)
- 2) ◀ : While in the menu mode, use this button to scroll to the Left.

11. STOP / ▼ - This button performs two functions:

- 1) STOP : Use this button to stop recording or playback.
- 2) ▼ : While in the menu mode, use this button to scroll Down.

12. FF / ▶ - This button performs two functions:

- 1) FF : During playback, use this button to Fast Forward the video (Press the FF button again to adjust the speed from 1, 2, 4, 8, 16, 32 times)
- 2) ▶ : While in the menu mode, use this button to scroll Right.

13. PAUSE / ▲ - This button performs two functions:

- 1) Pause : During playback, use this button to Pause the video.
- 2) ▲ : While in the menu mode, it works as an Up button.

14. PLAY - Initiates video Playback. For more information on Playback, refer to page 19. Press this button to playback the most recent recording.

15. CAMERA SELECT (1-4) - Press the Camera Select Buttons (1-4) to select the channel to be displayed in full screen.

BACK PANEL : _____

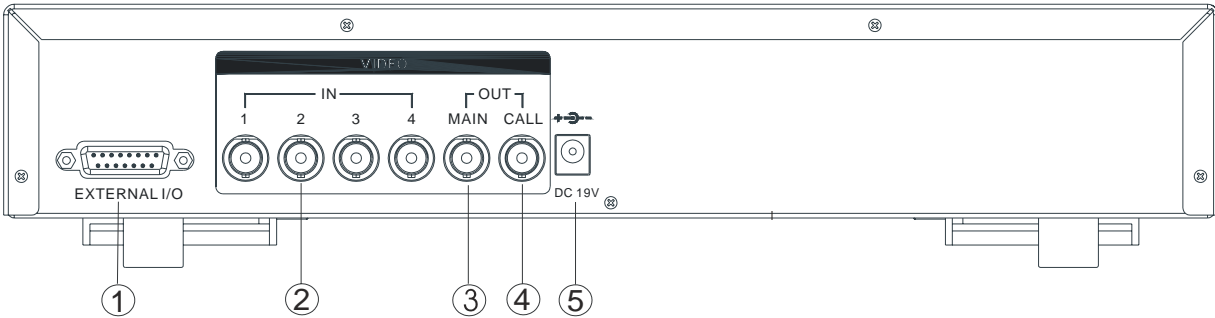

- 1. EXTERNAL I/O** - Allows for remote control by an external device or control system such as Video Web Server, or PC. Alternatively connects to an Alarm input sensor, such as a motion sensor .
- 2. VIDEO INPUT (1-4)** - Connect to video a source, such as camera (BNC Connection). The video outputs from the desired cameras to these inputs.
- 3. MAIN** – Connect the main display monitor to this output. The DVR's Menu, Video Playback, and live camera views will be displayed on this monitor. (BNC Connection).
- 4. CALL** – Connect a secondary call monitor to this output. The active camera will be displayed in sequence on this output.. (BNC Connection)
- 5. POWER** – Connect the supplied 19V power adapter to this input.

MAIN MENU CONTROL: _____

Enter the MENU screen by pressing the Menu button. Scroll through the 12 options by pressing the UP and DOWN buttons. To enter a sub-menu, press the ENTER button once the correct selection has been made. To exit the Main Menu, press the Menu button.

Outlined below are the buttons used for Menu setting :

“▲” and “▼” : Scroll up and down within a menu option

“◀” and “▶” : Scroll sideways within a menu option that has been selected

“+” and “-” : Increase and decrease the number or change values when an option is selected and is blinking

ENTER : Select a submenu/an option under a submenu for browsing / modification

MENU : Complete modification of a menu option; exit a menu

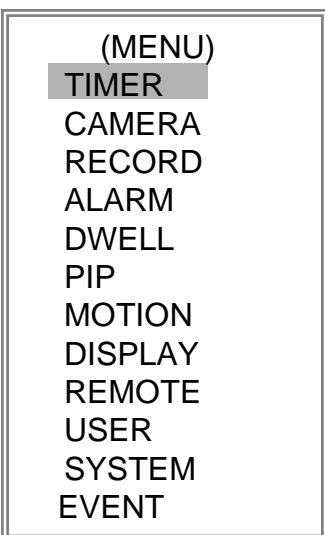

There are 12 options available in the Main Menu:

TIMER ----- Program Timer Recording

CAMERA ----- Camera Setup

RECORD ----- Recording Mode Setup

ALARM ----- Alarm Setup

DWELL ----- Dwell time Setup

PIP ----- Picture in Picture Setup

MOTION ----- Motion Detection Setup

DISPLAY ----- Display Mode Setup

REMOTE ----- Remote Control Setup

USER ----- User Password Setup

SYSTEM ----- System Setup

EVENT ----- Event List

After 60 seconds of Inactivity in the Menu mode, the system will go back to the live camera screen

1. **TIMER**

This Submenu allows you to Schedule times in which you're programming the DVR to record automatically.

(i) **DAY**

Select the day, or days of the week (Mon–Fri/Sat-Sun/Daily) that you wish to schedule the DVR to automatically record.

NOTE :

1. Change the date by “+” and “-” buttons.
2. If you have selected the date and **Timer** recording set from a specific day to a new day, then the **Timer** Recording Schedule will interpret the recording time as a whole week. For a specific date of **Timer** recording Schedule, it is not recommended to set Ending Time over 23:59.

For example: If you set Timer Schedule Day as Sunday, and START from 11:30 am, but End on 00:20 am, then Recording Timer Schedule is set as from every Sunday's 11:30 am to next Sunday's 00:20 am. If you only want to set Recording Timer Schedule from every Sunday 11:30 am to Monday 00:20 am, then you should set Recording Timer Schedule as Sunday from 11:30 am to 23:59 pm, and Monday from 00:00 am to 00:20 am.

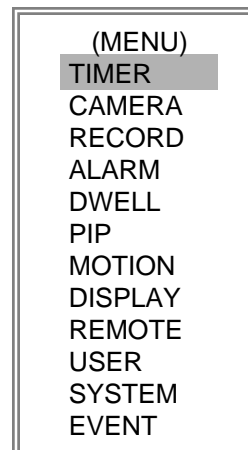

(ii) **START** - Set the time to start the recording.

(iii) **END** - Set the time to end the recording.

(iv) IPS (IMAGES PER SECOND)

Allows you to set the Images Per Second for recording. Available IPS settings are: 1, 2, 4, 8, 15, 30. 1 IPS is the slowest speed; it will allow for the longest recording durations as it records less information. Please refer to Appendix #7 for the different recording times.

(TIMER)					
DAY	START	END	IPS	QLT	MODE
DAILY	01:00	22:00	30	BEST	Q-FR
OFF	00:00	00:00	30	BEST	Q-FI
OFF	00:00	00:00	30	BEST	Q-FI
OFF	00:00	00:00	30	BEST	Q-FR
OFF	00:00	00:00	30	BEST	Q-FR
OFF	00:00	00:00	30	BEST	Q-FR
OFF	00:00	00:00	30	BEST	MUX
OFF	00:00	00:00	30	BEST	Q-FI
TIMER ENABLE : YES					

(v) **QUALITY** - Select the quality of recording image: BEST, HIGH, NORMAL and BASIC.

(vi) **MODE** - There are three recording mode settings : QUAD-FRAME, QUAD-FIELD, and MULTIPLEX. Please refer to Page 10 for an explanation on these record settings

(vii)TIMER ENABLE

When the TIMER ENABLE is set to “YES”, (menu screen above), and you press the “menu” button, you will see a timer chart, located to the right. This chart shows you the start and stop times for the various days of the week.

1ST	00--05	06--11	12--17	18--23
MON	☒☒☒☒☒☒	☒☒☒☒☒☒	☒☒☒☒☒☒	☒☒☒☒☒☒
TUE	☒☒☒☒☒☒	☒☒☒☒☒☒	☒☒☒☒☒☒	☒☒☒☒☒☒
WED	☒☒☒☒☒☒	☒☒☒☒☒☒	☒☒☒☒☒☒	☒☒☒☒☒☒
THU	☒☒☒☒☒☒	☒☒☒☒☒☒	☒☒☒☒☒☒	☒☒☒☒☒☒
FRI	☒☒☒☒☒☒	☒☒☒☒☒☒	☒☒☒☒☒☒	☒☒☒☒☒☒
SAT	☒☒☒☒☒☒	☒☒☒☒☒☒	☒☒☒☒☒☒	☒☒☒☒☒☒
SUN	☒☒☒☒☒☒	☒☒☒☒☒☒	☒☒☒☒☒☒	☒☒☒☒☒☒
2ND	00--05	06--11	12--17	18--23
MON	☒☒☒☒☒☒	☒☒☒☒☒☒	☒☒☒☒☒☒	☒☒☒☒☒☒
TUE	☒☒☒☒☒☒	☒☒☒☒☒☒	☒☒☒☒☒☒	☒☒☒☒☒☒
WED	☒☒☒☒☒☒	☒☒☒☒☒☒	☒☒☒☒☒☒	☒☒☒☒☒☒
THU	☒☒☒☒☒☒	☒☒☒☒☒☒	☒☒☒☒☒☒	☒☒☒☒☒☒
FRI	☒☒☒☒☒☒	☒☒☒☒☒☒	☒☒☒☒☒☒	☒☒☒☒☒☒
SAT	☒☒☒☒☒☒	☒☒☒☒☒☒	☒☒☒☒☒☒	☒☒☒☒☒☒
SUN	☒☒☒☒☒☒	☒☒☒☒☒☒	☒☒☒☒☒☒	☒☒☒☒☒☒

Note: If the user stops the Timer Recording during the timer period, you must restart the scheduled recording by pressing the “REC + ENTER” keys together.

2. CAMERA

This submenu allows you to set up parameters for each camera. You can set up the title, type of alarm sensor, the camera you want to record from, and control of picture Brightness, Contrast, Color and Hue for each camera.

(i) **TITLE** - Assign a title to each camera (Max: 8 characters). Initially each title is the camera’s number. (Example: Camera 1)

(ii) **ALARM** - This sets the polarity trigger for the corresponding external alarm input.
 Low: N/O (Normally Open type circuit)
 High: N/C (Normally Closed type circuit)
 Select LOW/OFF/HIGH for alarm polarity. The default value is LOW.

(MENU)
TIMER
CAMERA
RECORD
ALARM
DWELL
PIP
MOTION
DISPLAY
REMOTE
USER
SYSTEM
EVENT

(CAMERA)						
TITLE	ALARM	REC	BR	CT	CL	HUE
CAMERA01	LOW	ON	18	15	15	18
CAMERA02	OFF	OFF	18	15	15	18
CAMERA03	HIGH	OFF	18	15	15	18
CAMERA04	HIGH	ON	18	15	15	18

(iii) **REC (RECORD)** - Set up which channel you want to record.

ON: When an alarm input is triggered the DVR will begin recording when an alarm is detected on this input. The DVR will record the alarming channel more frequently. For example : when CH01 is triggered, the record method will become 1-2-1-3-1-4....

OFF: The DVR will not record when an external alarm is triggered.

(iv) **BR (BRIGHTNESS)**

Adjust the brightness of each channel. The level is from 0 to 63. The default setting is 37.

(v) **CT (CONTRAST)**

Adjust the contrast of each channel. The level is from 0 to 63. The default setting is 18.

(vi) **CL (COLOR)**

Adjust the color of each channel. The level is from 0 to 63. The default setting is 13.

(vii) **HUE (HUE)**

Adjust the hue of each channel. The level is from 0 to 63. The default setting is 00.

3. RECORD

This submenu allows you to set the Record parameters for your Hard Disk Drive. Use this section to configure your record settings. The selected IPS and Quality will determine how long the DVR will record for. Use the chart in Appendix #7 to select the appropriate settings

(i) **RECORD IPS** – Allows you to set the Images Per Second for recording. The available IPS settings are 1, 2, 4, 8, 15, 30. The Default setting is 30.

(ii) **QUALITY** – Sets the quality level of recording. Available settings are: BASIC, NORMAL, HIGH, BEST. The default setting is: NORMAL.

(MENU)
TIMER
CAMERA
RECORD
ALARM
DWELL
PIP
MOTION
DISPLAY
REMOTE
USER
SYSTEM
EVENT

NOTE : Higher quality recording consumes more memory on your HDD. Appendix #7 shows the different recording speed associated with the type of setting that you select.

(iii) RECORD MODE - There are three recording settings : QUAD-FRAME, QUAD-FIELD, & MULTIPLEX.

(RECORD)	
RECORD IPS	30
QUALITY	NORMAL
RECORD MODE	QUAD-FRAME

- (a) Quad-Frame – The DVR will record all cameras in a Quad Split screen. Images will be saved as a complete frame consisting of 2 images.
- (b) Quad-Field - The DVR will record all cameras in a Quad Split screen. Images will be saved 1 field at a time. This usually ensures more fluent playback of video.
- (c) Multiplex – The DVR will record all cameras in individual full screen samples.

Note: 1) The Quad mode will offer a higher IPS rating per camera, but are recorded at a lower resolution.

Example: If the Record IPS is set to 30, all 4 cameras are recorded at this setting at a resolution of 320 x 240.

2) The Multiplex mode offers a higher resolution (Full Screen 720 x 480) rating per camera, but at a lower IPS.

Example: If the Record IPS is set to 30, this number is divided by the 4 cameras. This yields 7.5 IPS per camera.

4. ALARM

(i) ALARM ENABLE – The alarm will be activated by a trigger on the external alarm input. It is triggered by an event occurrence, such as a camera’s PIR alarm function when the setting is” YES”. Selecting “NO” will disable the alarm setting.

(ii) ALARM DURATION – Set the length of the alarm time. The DVR will emit a buzzer if enabled in system setting. The Default setting is 10 Sec. Options are 10 Sec, 15 Sec, 20 Sec, 30 Sec, 1 MIN, 2 MIN, 3 MIN, 5 MIN, 10 MIN, 15 MIN, 30 MIN, ALWAYS, AUTO.

NOTE : When the setting is set to AUTO, the alarm will continue for the duration of the external alarm

(MENU)
TIMER
CAMERA
RECORD
ALARM
DWELL
PIP
MOTION
DISPLAY
REMOTE
USER
SYSTEM
EVENT

(ALARM)	
ALARM ENABLE	YES
ALARM DURATION	15 MIN
RECORD IPS	30
QUALITY	NORMAL
RECORD MODE	QUAD-FRAME

(iii) **REC IPS** - Select the images per second of recording during an ALARM. Available settings are 1, 2, 4, 8, 15, 30. The default setting is 30.

(iv) **QUALITY** - There are four recording quality settings during an ALARM: BASIC, NORMAL, HIGH, BEST.

(v) **RECORD MODE** - There are three recording settings : QUAD-FRAME, QUAD-FIELD & MULTIPLEX.

5. DWELL

(i) **NORM** - Select to setup the time duration between each channel rotation in the camera sequence mode displayed on the call monitor. The duration is from 1 to 15 Sec or OFF. The default setting is 02.

(ii) **ALARM** - Select the DWELL time period to be used when an alarm input is triggered. The level is from 1 to 15 Sec or OFF. The default setting is 02.

(DWELL)		
	NORM	ALARM
CAM1	01	01
CAM2	01	01
CAM3	01	01
CAM4	01	01

(MENU)
TIMER
CAMERA
RECORD
ALARM
DWELL
PIP
MOTION
DISPLAY
REMOTE
USER
SYSTEM
EVENT

6. PIP

Use this section to set the cameras for Picture in Picture mode as well as the screen position of the PIP window.

(i) FULL SCREEN

Selects the camera shown as a full screen in PIP mode.

(ii) PIP SCREEN

Selects the camera shown as a 1/9 size sub-screen in the PIP mode.

(iii) POSITION

There are six different positions where the PIP sub-screen can be displayed on the monitor : D/L, D/M, D/R, U/L, U/M, U/R.

D/L: Down Left, D/M: Down Middle, D/R: Down Right,

U/L: Upper Left, U/M: Upper Middle, U/R: Upper Right

(PIP)	
FULL SCREEN	CAM 1
PIP SCREEN	CAM 2
POSITION	D/R

(MENU)
TIMER
CAMERA
RECORD
ALARM
DWELL
PIP
MOTION
DISPLAY
REMOTE
USER
SYSTEM
EVENT

7. Motion

This section allows you to configure the DVR's video motion detection feature. This allows the DVR to record when changes are detected in the camera's field of view. This is a Pixel Based Detection feature.

(MENU)
TIMER
CAMERA
RECORD
ALARM
DWELL
PIP
MOTION
DISPLAY
REMOTE
USER
SYSTEM
EVENT

(i) SEN (SENSITIVITY)

Select the level of the pixel-based Motion Sensing's sensitivity level by channel or camera. The sensitivity ranges from 1 to 99. The highest sensitivity setting is 01, the lowest sensitivity setting is 99. The default setting is 70.

(ii) MD-NUM (MOTION DETECTION NUMBER)

Sets the number of targets in which Motion must occur in order to trigger an Alarm (from 1-99 target areas).

Note: MD-NUM cannot be less than the number of targets set in the AREA.

(MOTION)					
	SEN	MD-NUM	RE	DET	
CAM1	70	03	64	ON	AREA
CAM2	70	03	64	OFF	AREA
CAM3	70	03	64	ON	AREA
CAM4	70	03	64	ON	AREA

MOTION RECORD : ON		
DAY	START	END
DAILY	00 : 00	00 : 00

(iii) RE (REFERENCE)

Set the Reference image to which the current screen is compared (from 1-99). For example, the value 64 would compare to the current image on the 64th previous screen image.

(iv) DET (DETECTION)

The motion detection on each channel can be turned ON or OFF individually.

(v) AREA

Press the ENTER button on this option to set the Pixel-based Motion Detection Area for each channel. The Red target represents where the target is (Figure 1-1). The Green target represents the Motion Detection Area (Figure 1-2), and Purple target represents the motion currently taking place on screen (Figure 1-3). After motion stops detecting, the color of the target will turn green (Figure 1-4).

To modify the Motion Detection Area, use the following controls

 : turns the selected target ON/OFF.

 : navigates between targets

- : turns all targets on the screen ON/OFF

+ : turns all targets in the selected row ON/OFF

Note: When the "DET" (DETECTION) setting is "ON", you must set the motion detection AREA, or motion will not be triggered.

Figure 1-1

MOTION DETECTION SETUP

	1	2	3	4	5	6	7	8	9	10	11	12	13	14	15	16
1																
2																
3																
4																
5						■										
6																
7																
8																
9																
11																
12																

Figure 1-2

MOTION DETECTION SETTING — ROW SETUP

	1	2	3	4	5	6	7	8	9	10	11	12	13	14	15	16
1																
2					■	■	■									
3					■	■	■									
4					■	■	■									
5	■	■	■	■	■	■	■	■	■	■	■	■	■	■	■	■
6																
7																
8																
9																
11																
12																

Figure 1-3

MOTION DETECTION TRIGGERED-TURNS PURPLE

	1	2	3	4	5	6	7	8	9	10	11	12	13	14	15	16
1																
2						■	■	■								
3						■	■	■								
4						■	■	■								
5	■	■	■	■	■	■	■	■	■	■	■	■	■	■	■	■
6																
7																
8																
9																
11																
12																

Figure 1-4



BACK TO MOTION DETECTION SETTING

	1	2	3	4	5	6	7	8	9	10	11	12	13	14	15	16
1																
2						■	■	■								
3						■	■	■								
4						■	■	■								
5	■	■	■	■	■	■	■	■	■	■	■	■	■	■	■	■
6																
7																
8																
9																
11																
12																

(vi) MOTION RECORD

When the DET setting is “ON”, you can set up the MOTION RECORD function.

1. Select “ON” to enable the motion trigger recording: The system will automatically switch to the Record Mode upon pixel-based motion detection. The motion detection will also change the scanning sequence and show  on the monitor.

For example: If the motion is detected on Camera #1, the recording & scanning sequence will be more frequent on that channel. The sequence will be: 1st, 2nd, 1st, 3rd, 1st, 4th. Channel 1 will show  on the screen. If the 2nd and 3rd camera are both motion activated, they will be scanned as 2nd, 3rd, 1st, 2nd, 3rd, 4th, 2nd, 3rd, 1st, 2nd, 3rd, 4th ... and vice versa. CH2 & CH3 will show  for the same period of time that the Alarm Duration time is set for.

NOTE: The trigger recording time will depend on the ALARM DURATION mode setting (Please refer to page 10 for ALARM DURATION) and will record from the last trigger time. For example, when the alarm duration setting is 1 min, the recording time is from 9:00:00 to 9:01:00. If the motion detection is triggered again at 9:00:40, the triggered recording time will be from 9:00:00 to 9:00:40 and 9:00:40 to 9:01:40. The total recording time is 00:01:40.

2. Select "OFF": The screen still shows  and if it's in the record mode, the motion detection will change the scanning sequence.

(vii) DAY / START / END

To setup the DAY and the START/ END time for motion trigger record timer setting.

8. DISPLAY

(i) TITLE DISPLAY

Selecting "YES" will enable the camera title to appear on the monitor. Selecting "NO" will remove all titles from appearing on the monitor.

(ii) OSD COLOR

Select the OSD (On Screen Display) color. The options are YELLOW, GREEN, CYAN, BLUE, PINK, GRAY, WHITE, RED.

(MENU)
TIMER
CAMERA
RECORD
ALARM
DWELL
PIP
MOTION
DISPLAY
REMOTE
USER
SYSTEM
EVENT

(DISPLAY)	
TITLE DISPLAY	YES
OSD COLOR	YELLOW
LOSS SCREEN	GREEN
TIME POSITION	NORMAL

(iii) LOSS SCREEN

This option determines what will be shown if video is lost. Select RETAIN to keep the last image shown or a color to be shown full screen. The options are: GREEN, BLACK, BLUE and RETAIN.

(iv) TIME POSITION

To set the OSD POSITION shown on the monitor. The options are NORMAL (Top Right) or CENTER.

9. REMOTE

(i) REMOTE MODE

Set the remote mode for connection to a computer via the RS-232 or RS-485 port. This allows for the control of the unit only – no viewing (Please refer to Appendix #4 and #6 for more information on the RS-232 & RS-485 Remote Control).

(ii) BAUD RATE

Sets the speed at which the RS-232 or RS-485 input and the computer communicate. Baud Rate, which is the rate of data transmission can be set to: 115200, 57600, 19200, 9600, 4800, 3600, 2400, or 1200.

(MENU)
TIMER
CAMERA
RECORD
ALARM
DWELL
PIP
MOTION
DISPLAY
REMOTE
USER
SYSTEM
EVENT

(iii) ID

To be able to control different DVR's, a remote protocol setting is used. The ID number can be set from 000 to 255.

(REMOTE)	
REMOTE MODE	RS-485
BAUD RATE	9600
ID	255

10. USER

(i) USER

Allows you to set up the user account for controlling the DVR. The system will allow for up to 8 users to have access.

Supervisor – Control all the functions.

Other Users – View all functions except the menu setting.

(ii) PASSWORD

Used to set the security password for each account. The maximum length for the user password is 4 characters.

NOTE: To switch to a different USER, press the “ENTER” & “MENU” buttons together (“KEY LOCK”) and then enter the user’s password to UNLOCK.

(MENU)	
TIMER	
CAMERA	
RECORD	
ALARM	
DWELL	
PIP	
MOTION	
DISPLAY	
REMOTE	
USER	
SYSTEM	
EVENT	

(USER)	
PASSWORD	
SUPERVISOR	0000
USER 1	0000
USER 2	0000
USER 3	0000
USER 4	0000
USER 5	0000
USER 6	0000
USER 7	0000

11. SYSTEM

(i) BUZZER

Select the BUZZER setting to “ON” or “OFF” When the buzzer is “ON” it will sound when an external alarm event occurs.

(ii) EXT ALARM

If you select “ON” for the EXT ALARM (External Alarm), an alarm will occur upon activation on the “Alarm In” terminals.

(iii) VLOSS ALARM

Sets the VLOSS ALARM (Video Loss Alarm). When the setting is “ON”, the alarm buzzer will sound upon loss of video on any of the 4 channel inputs

(MENU)	
TIMER	
CAMERA	
RECORD	
ALARM	
DWELL	
PIP	
MOTION	
DISPLAY	
REMOTE	
USER	
SYSTEM	
EVENT	

(iv) KEY MUTE

When the KEY MUTE is set to “YES”, there will be no sound when you press any of the keys during operation.

(v) HDD OVERWRITE

When enabled (YES), recording will continue uninterrupted when the HDD is full. The previous recording will be Overwritten in a “first in, first out” basis.

(SYSTEM)		
BUZZER		ON
EXT ALARM		ON
VLOSS ALARM		ON
KEY MUTE		YES
HDD OVERWRITE		YES
MESSAGE LATCH		YES
DATE DISPLAY		D/M/Y
DATE	26-DEC-2003	[FRI]
TIME		22:55:34
CLEAR HDD		YES
SYSTEM RESET		YES

When disabled (NO), recording will stop when the HDD fills up. It will then need to be cleared in order for recording to continue.

(vi) MESSAGE LATCH

If “YES” is selected the DVR alarm messages remain on the screen until acknowledged by the user with a key-press. If “NO” is selected the DVR message will disappear after 10 seconds. “NO” is the default setting.

(vii) DATE DISPLAY – There are 3 formats to display the date on the screen: Y/M/D, M/D/Y, D/M/Y or OFF. Choosing OFF will remove the date on the monitor.

(viii) DATE – Used to set the date on the DVR.

(ix) TIME – Used to set the time on the DVR. (Set in military format)

(x) CLEAR HDD

Deletes all the contents on the HDD. When you choose “YES” on this option, press “ENTER” and you will be prompted with the question shown: Press “→” to clear HDD or press “←” to cancel. **Note:** All data on the HDD will be lost if this is performed.

(xi) SYSTEM RESET

Resets the DVR back to the factory default settings. Select “YES” and press “ENTER” to confirm switching it back to the default settings.

12. EVENT

The event log keeps a record of all errors and alarms that may occur on the DVR. Each of these are stored with a Time/Date Stamp. A single page can display 16 recorded events. Press “◀” or “▶” to change the pages, or press “▲” + “▼” to CLEAR the EVENT record.

(MENU)	
TIMER	
CAMERA	
RECORD	
ALARM	
DWELL	
PIP	
MOTION	
DISPLAY	
REMOTE	
USER	
SYSTEM	
EVENT	

List of possible events

DISK FULL: HDD is full
PWR REST : Power restored
M-HD REMS: HDD removal
M-HD REPL: HDD replace
M-HD ERR : HDD error
M-HD WARM: HDD warning
K UNLOCKS: Key is unlocked
DMA ERROR: DMA error (Direct Memory Access)
C1 VLOSS : Video loss on CH 1
C2 ALARM : Channel 2 has been triggered by
 an external I/O alarm
C3 MOTION: Channel 3 has been triggered
 by motion
SYSTEM ERROR: System fail
POWER RESTORE : Power restored

C1 VLOSS	26-DEC-2002	03:00:00
C2 ALARM	26-DEC-2002	03:00:00
K UNLOCKS	26-DEC-2002	03:00:00
M-HD ERR	26-DEC-2002	03:00:00
M-HD WARM	26-DEC-2002	03:00:00
PWR REST	26-DEC-2002	03:00:00
DMA ERROR	26-DEC-2002	03:00:00
M-HD REPL	26-DEC-2002	03:00:00
↑ + ↓ : CLEAR		

OPERATION: _____

Please Note: If the DVR was disconnected, or a power failure was to occur, the back-up battery would supply power for 48 hours. After 48 hours the time and date will default back to the factory setting, and will have to be manually reset. All other settings will remain the same.

1. CAMERA SELECT (1-4)

Press Camera Select (1-4) to select the camera to display in full screen

2. RECORDING

The DVR offers 4 recording modes listed below. Please refer to Pg.30 for a chart of recording speeds and resolution. Note: During recording, if the power was turned off accidentally, recorded video will still be stored in the HDD. The DVR will return to the original recording setting after the power is restored.

When you press the “**REC**” button on the DVR, you will find the date, time, recording type, and the available HDD space (in GB). The letter “ **M** ” represents the recording mode. Manual in this case. (OW represents HDD Overwrite)

NOTE : 1. When the HDD is full under the O/W Recording mode, previous recorded files will be overwritten without any further warning.

2. If the HDD has only 5 GB of space left, it will display “5 GB” on the upper- right part of the screen and will be displayed in orange. It will buzz for a few seconds. The same applies when there’s 4GB, 3GB, 2GB or 1GB of HDD space remaining. If the O/W (Overwrite) Recording mode is on, it won’t have the warning buzzer.

(OW : HDD Overwrite)

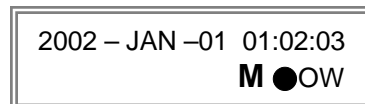

There are 4 recording modes: Alarm, Motion, Timer and Manual Recording.

(i) **ALARM RECORDING**

DVR is triggered by an external alarm input. The  symbol will be shown on the triggered channel (refer to page 10).

(ii) **MOTION RECORDING**

The DVR will record when motion  (pixel-based) is detected on the camera. Refer to Page 13 for instructions on setting the unit for motion detection.

(iii) **TIMER RECORDING**

Recording is activated by a Timer schedule, indicated by the symbol “ **T** “. Refer to page 7 for instructions on how to set schedules for recording.

(iv) **MANUAL RECORDING**

Recording is initiated manually by pressing the REC button, indicated by the letter “ **M** “. In this case, recording will continue until “STOP” is pressed on the unit.

Note: *In all recording modes, recording will occur on all connected camera’s. There is no way to record only on specific channels*

3. PLAY BACK

Pressing the “PLAY” button on the DVR will show the last recording. The following controls are available during playback

(i) FAST FORWARD (FF) & FAST REWIND (FR)

You can increase the speed of Fast Forward and Rewind on the DVR.

In the Play mode, press “▶” once to get 2X speed in forward. Press this key twice to get 4X speed. The maximum speed is 32X.

Press “◀” once to get 1X speed in rewind. Press this key twice to get 2X speed. The maximum speed is 32X.

(ii) SLOW FORWARD (SF) & SLOW REWIND (SR)

You can also slow down the speed when Forwarding or Rewinding on the DVR.

When in the Play mode, pressing the SLOW button will enter the Slow mode.

Press “SLOW” once to get 1/2X speed in forward. Press forward “▶” to get 1/4X speed. The slowest speed is 1/32X.

Press “◀” once to get 1/2X speed in rewind. Press this key twice to get 1/4X speed. The slowest speed is 1/32X.

(iii) PAUSE

You can pause the playback. The image will be displayed on the screen.

(iv) STOP

Pressing the “STOP” button will stop all DVR operations and return to the live monitoring mode.

(v) IMAGE JOG FUNCTION

This will allow you to manually view video frame-by-frame, one image at a time.

While in the PLAY mode, pressing the “PAUSE” button will pause the screen.

Pressing the “▶” button advances the frozen screen one image forward.

Pressing the “◀” button moves back one image.



4. SEARCH

(i) **LAST RECORD**

Plays the last recorded video event.

(ii) **FULL LIST**

Lists all recorded video on the HDD, sorted by time.

-  : Motion Recording
- M** : Manual Recording
-  : Alarm Recording
- T** : Timer Recording
- M** : Storage in Master HDD

NOTE: It will display a different color for each record list mentioned above.

(iii) **ALARM LIST**

Lists all recorded video triggered by an Alarm.

NOTE : If there are no Alarms in the record list, the screen will be blank.



(iv) **MOTION LIST**

Lists all recorded video triggered by motion (pixel-based).

(v) **TIME SEARCH** **T**

Finds video recorded on a specific date & time that is entered, and the total number of minutes recorded.

LAST RECORD
FULL LIST
ALARM LIST
MOTION LIST
TIME SEARCH

T 2003-JAN-01 01:02:03 **M**
T 2003-JAN-05 05:02:03 **M**
 2003-MAR-12 04:02:03 **M**
 2003-APR-02 03:02:04 **M**
M 2003-MAY-01 05:02:03 **M**
M 2003-AUG-09 01:02:01 **M**
← : PAGE UP → : PAGE DOWN

PLAY TIME: 2004-JUNE-29 13

5. VIDEO LOSS

The screen will display “VLOSS” in the center of the monitor if the video input loses the video signal.

KEY LOCK: _____

For advanced security, you can “Lock” the buttons on your DVR. Key-Lock prevents other people from using the system.

Press the ENTER and MENU keys at the same time to enable the Key Lock.

Press the ENTER and MENU keys at the same time, key in your password (Default : 0000), and then press the “ENTER” key to disable the Key Lock.

NOTE: To switch to a different USER, press the “ENTER” + “MENU” buttons together to “KEY LOCK”. Enter a different user’s password to UNLOCK.

TROUBLESHOOTING: _____

When a malfunction occurs, it may not be serious and can be corrected easily. The following table describes the most common problems and solutions. Please read this table thoroughly before calling your DVR dealer.

PROBLEM	SOLUTION
No power	<ul style="list-style-type: none">• Check power cord connections.• Confirm that there is power at the outlet.
Not responding when any of the buttons are pushed	<ul style="list-style-type: none">• Check if it is under Key Lock mode.• Press the "MENU" & "ENTER" keys together to exit Key Lock mode
No recorded video	<ul style="list-style-type: none">• Check if the HDD is installed properly.
Timer Record enable does not work	<ul style="list-style-type: none">• Check if the Time Enable is set to YES.
No live video	<ul style="list-style-type: none">• Check camera video cable and connections.• Check monitor video cable and connections.• Confirm that the camera has power.• Check camera lens setting.
NTSC & PAL System switch	To switch the system, press "FF" for NTSC system, and "REW" for PAL system. (Refer to Page 3 "Getting Started").

TECHNICAL SPECIFICATIONS: _____

Video format	NTSC/EIA
Hard disk storage	IDE type, UDMA 66, supported 250 GB HDD
Record mode	Manual / Alarm / Timer
Camera Input Signal	Composite video signal 1 Vp-p 75 ohms BNC, 4 channels
Main Monitor Output	Composite video signal 1 Vp-p 75 ohms BNC
Call Monitor Output	Composite video signal 1 Vp-p 75 ohms BNC
Video Loss Detection	Yes
Refresh Rate	Up to 240 fields/sec.
Recording Rate	Multiplex: Up to 30 fields/sec Quad-field: Up to 120 fields/sec. Quad-frame: Up to 240 fields/sec.
Dwell Time	Programmable (1~15 Sec)
Picture in Picture	Yes (Movable)
Key Lock	Yes
Camera Title	8 letters
Video Adjustable	Hue/ Color/ Contrast/ Brightness Adjustable
Alarm Input	TTL input, Hi (5V), Low (GND)
Alarm Output	COM./N.O/N.C
Remote Control	RS-232 or RS-485
Time Display Format	YY/MM/DD, DD/MM/YY, MM/DD/YY, OFF
Power Source	DC 19V
Power Consumption	<32W
Operation Temperature	10 ~ 40°C (50°F ~ 104°F)
RS-232C / RS-485 (bps)	115200, 57600, 19200, 9600, 4800, 3600, 2400, 1200
Dimension (mm)	343(W) x 223(L) x 59(H)
Net Weight	1.5 kgs (3.31 lbs)

As our products are subject to continuous improvement, SVII and its subsidiaries reserve the right to modify product design, specifications and prices, without notice and without incurring any obligation. E&OE

APPENDIX #1 – INSTALLING THE HDD

Follow these steps carefully to ensure correct installation.

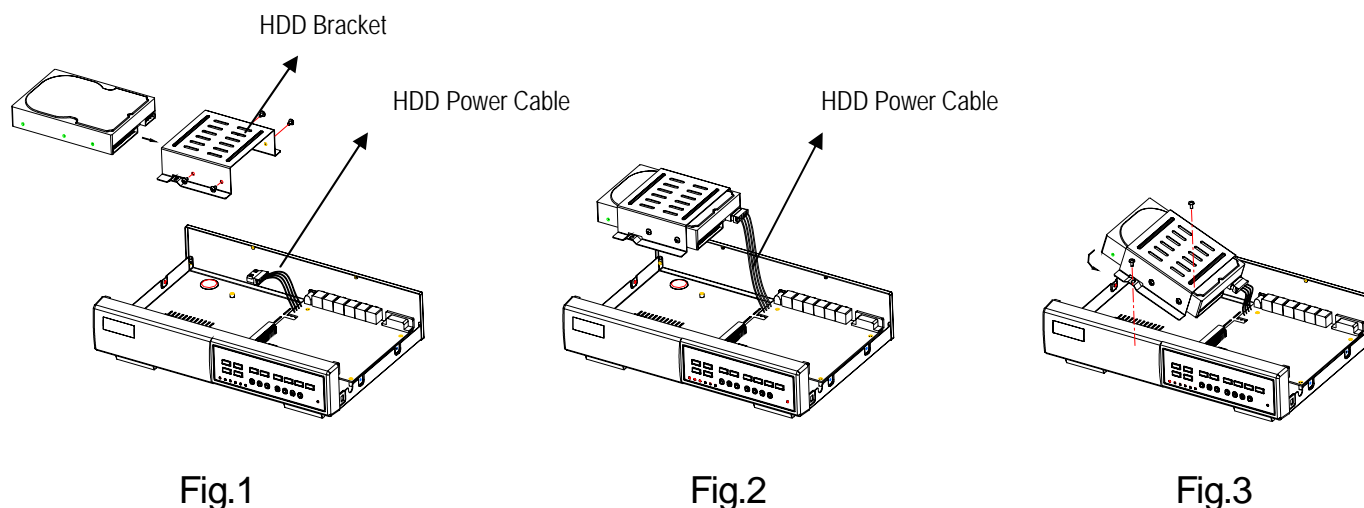

Fig.1

Fig.2

Fig.3

- Step 1** Remove the outer casing of the DVR unit (consisting of 8 screws), and then remove the HDD bracket (4 screws).
- Step 2** Insert the HDD into the HDD bracket and insert the four screws.
Note the location of the power cable, as shown above (Fig 1).
- Step 3** Connect the HDD power cable to the HDD (Fig. 2).
- Step 4** Attach the HDD connector to the 40-pin input, and screw the HDD and the DVR together (Fig. 3).
- Step 5** Replace the outer casing by pulling the sides of the lid apart slightly, and then push the lid down. (Insert the 8 screws)

Note: Make sure that the Hard Drive is set to “Master” before recording. Please refer to the HDD Manual for further information.

Do not try to retrieve the HDD data using your PC. The video file cannot be read by the PC. Any operation on the PC would damage the FAT table on the hard disk drive.

Note: *If you are planning on removing the HDD and replacing it with a higher capacity HDD, please be cautious with the high surface temperature of the DVR.*

APPENDIX #2 – TYPICAL CONFIGURATION FOR A COMPLETE SYSTEM

Shown below is an example of connecting the DVR to your existing Observation System using cameras, a main monitor and a call monitor. Other devices can be connected through the 15 pin com port (External I/O).

*The HDD must be installed before turning on the DVR. If the HDD is not installed, the DVR will function as a 4 CH multiplexer.

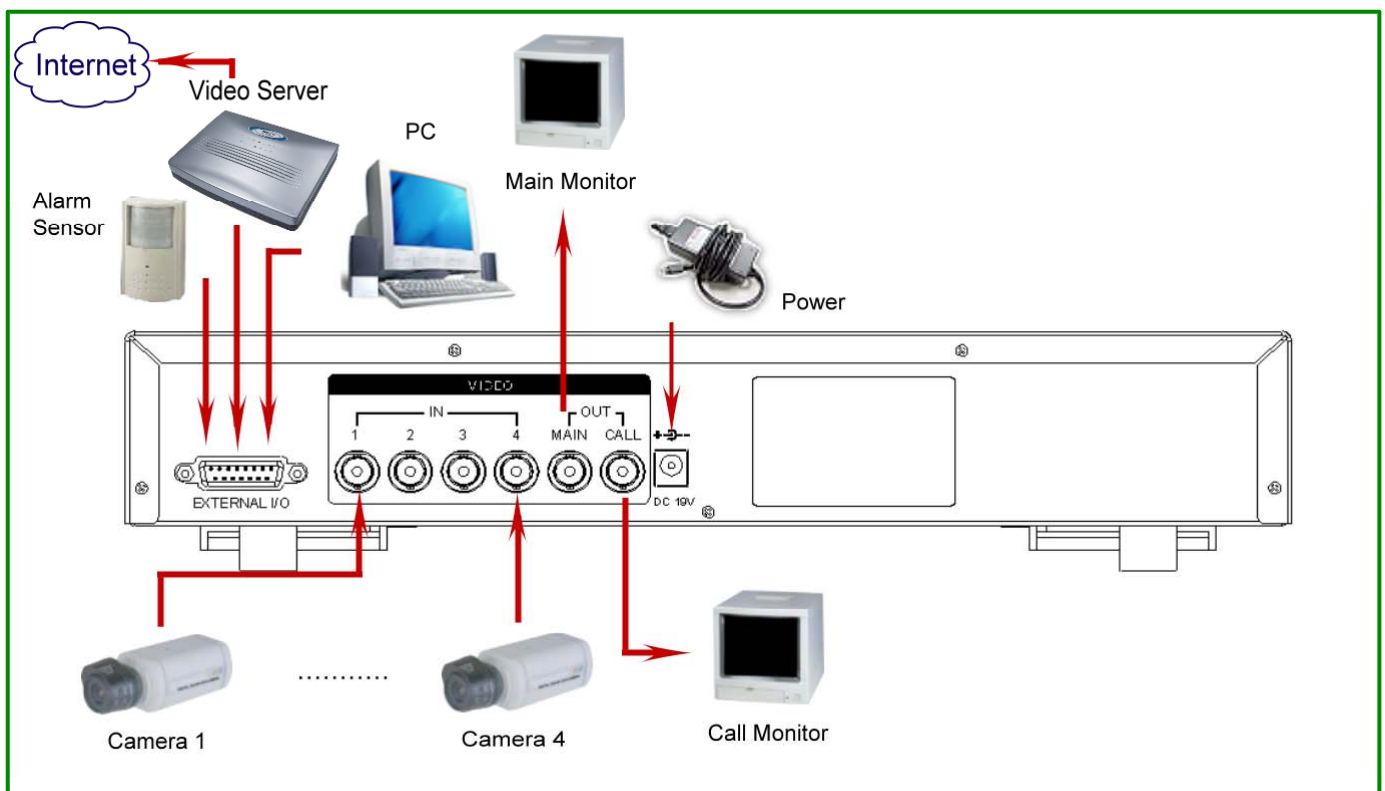

APPENDIX #3 – CONNECTING PIR’S TO THE DVR USING THE EXTERNAL I/O

PIR Motion sensors can be connected to the DVR as indicated below. A N/O (Normally Open, Low) or N/C (Normally Closed, High) contact can be used. You will need to go into the Menu set-up and select “Camera”. For each channel, you can set-up the “Alarm” for either Low, High or OFF

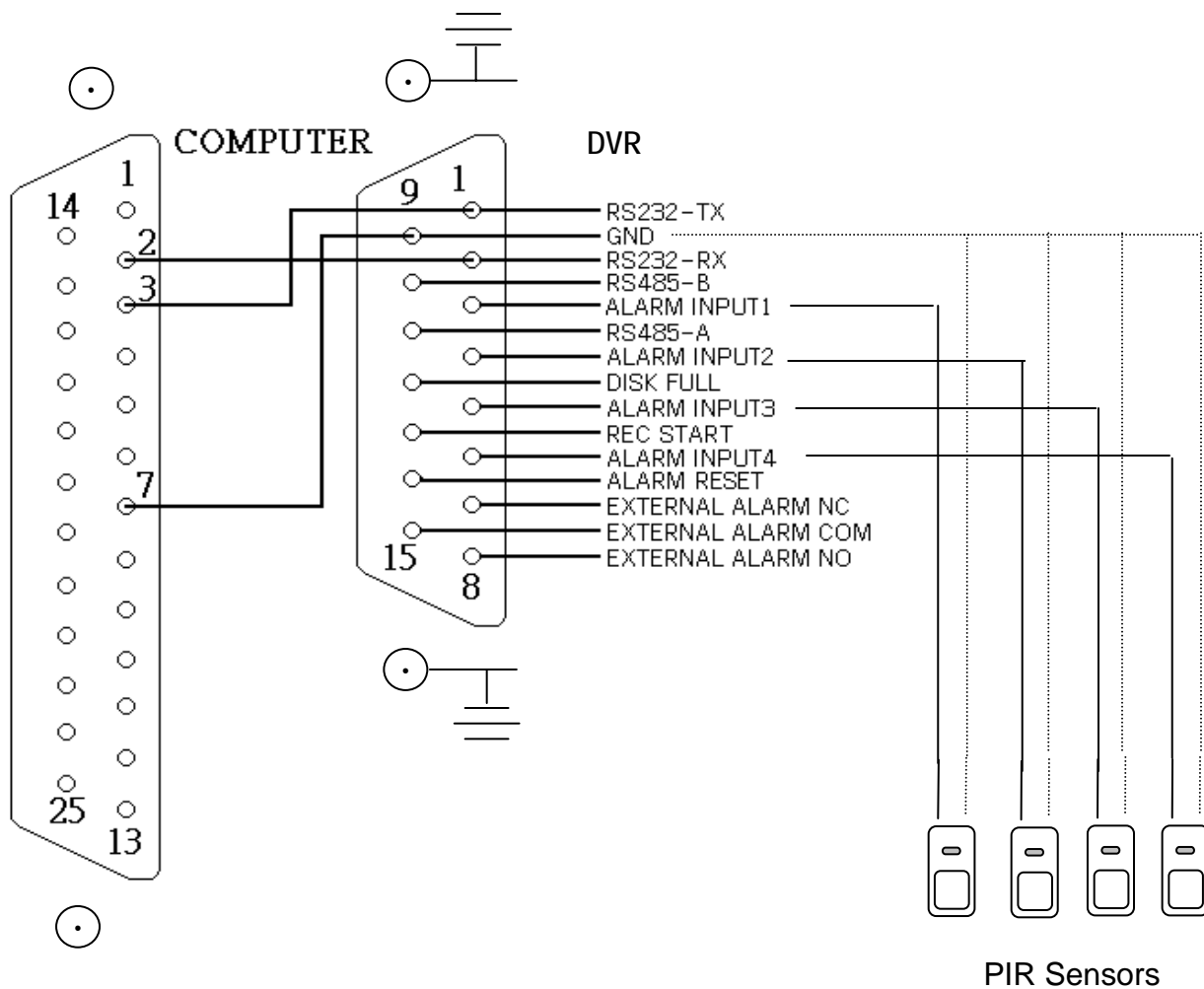

APPENDIX #4 – PIN CONFIGURATIONS FOR CONNECTION TO A COMPUTER

15 pin com port

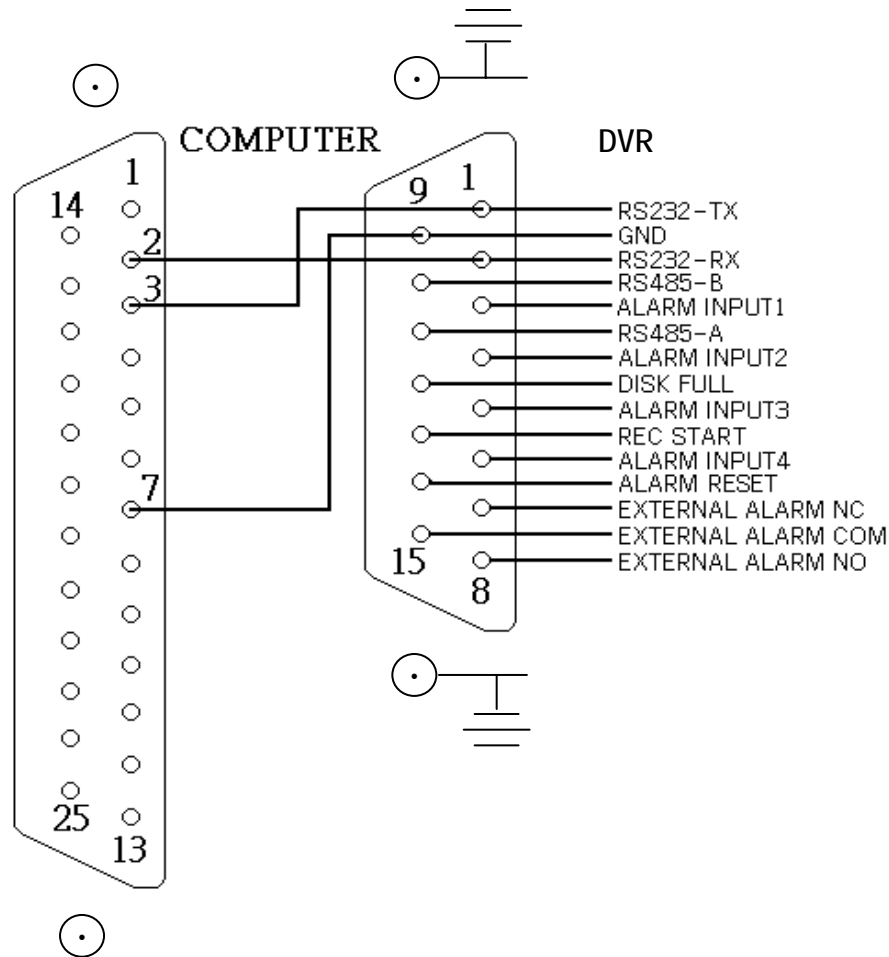

PIN 1. RS232-TX : RS-232

The DVR can be controlled remotely by an external device or control system, such as a control keyboard, using RS-232 serial communication signals.

PIN 2. RS232-RX : RS-232

The DVR can be controlled remotely by an external device or control system, such as a control keyboard, using RS-232 serial communication signals.

PIN 3, 4, 5, 6 ALARM INPUT

Connect a wire from the **ALARM INPUT (PIN 3, 4, 5, 6)** to the **GND (PIN 9)** connector. The DVR will start recording and the buzzer will be on. When the alarm has been triggered, the signal becomes “Low”, which will stop all alarm activity. Under normal operation, the signal remains “High”.

PIN 7. EXTERNAL ALARM NC

Under normal operation, COM connects with NC and disconnects with NO. When the alarm is triggered, COM disconnects with NC, and connects with NO.

PIN 8. EXTERNAL ALARM NO

Under normal operation, COM will disconnect from NO. When the alarm is triggered, COM will connect with NO.

PIN 9. GND

GROUND

PIN 10. RS485-B

The DVR can be controlled remotely by an external device or control system, such as a control keyboard, using the RS485 serial communication signals.

PIN 11. RS485-A

The DVR can be controlled remotely by an external device or control system, such as a control keyboard, using the RS485 serial communication signals.

PIN 12. DISK FULL (OUTPUT)

When the HDD is full, it sends a signal to trigger the next DVR record mode, if you install another DVR. Under normal operation, the signal remains "High". When the disk is full, the DVR will send a "Low" signal.

PIN 14. ALARM RESET (INPUT)

Connect a wire from the ALARM RESET (PIN 14) to the GND (PIN 9) connector, so it can disable the ALARM. An external signal to the ALARM RESET (PIN 14) can be used to reset both the ALARM OUTPUT signal and DVR's internal buzzer. When the alarm has been triggered, the signal becomes "Low", and will stop all alarm activity. Under normal operation, the signal remains "High".

PIN 15. EXTERNAL ALARM COM

Under normal operation, COM connects with NC and disconnects with NO. When the alarm is triggered, COM disconnects with NC, and connects with NO.

APPENDIX #5 – LIST OF COMPATIBLE HARD DISK DRIVES

Manufacturer	Model	Capacity	Rotation
HITACHI	Deskstar 180 GXP (120 GB)	120GB	7200 rpm
HITACHI	Deskstar 7K250, HDS722516VLAT20	160GB	7200 rpm
HITACHI	Deskstar 7K250, HDS722525VLAT80	250GB	7200rpm
HITACHI	Deskstar 120GXP (80GB)	80GB	7200 rpm
HITACHI	Deskstar 120GXP (120GB)	120GB	7200 rpm
Maxtor	DiamondMax 536DX(60GB) 4W060H4	60GB	5400 rpm
Maxtor	DiamondMax Plus 9	80GB	7200 rpm
Maxtor	DiamondMax Plus 9, Model#6Y120L	120GB	7200 rpm
Maxtor	DiamondMax Plus 9, Model#6Y160L0	160GB	7200 rpm
Maxtor	MaxLine Plus , Model#7Y250P0	250GB	7200 rpm
Seagate	Barracuda ATA IV, ST380021A	80GB	7200 rpm
Seagate	Barracuda ATA V, ST3120023A	120GB	7200 rpm
Seagate	Barracuda 7200.7 Plus, ST3160023A	160GB	7200 rpm
Western Digital	Caviar WD1200BB-00CAA1	120GB	7200 rpm
Western Digital	Caviar WD2000BB-00DWA0	200GB	7200 rpm
Western Digital	CaviarSE WD2500JB	250GB	7200 rpm

Brand	Capacity	Capacity after format	Format Time
HITACHI	250GB	217.6GB	9' 48"
HITACHI	160GB	142.5GB	6' 02"
HITACHI	80GB	70.8GB	4' 08"
HITACHI	40GB	35.0GB	3' 30"
SEAGATE	200GB	173.2GB	8' 23"
SEAGATE	160GB	138.4GB	7' 23"
MAXTOR	250GB	217.6GB	10' 12"
W. D.	250GB	216.8GB	10' 02"
W. D.	40GB	34.0GB	3' 30"

Other models of Hard Disk Drives may work with the Four Channel DVR, but the above models have been tested and are known to be compatible. We do not recommend using Hard Disk Drives that are unlisted.

APPENDIX #6 - RS232 REMOTE PROTOCOL

The RS232 / Alarm input allows you to control the DVR system from your PC. In order to achieve this, you will require an RS232 COM Port communication program installed on your PC. There are many of these software programs available on the internet, some of which are free.

For Pin Connection instructions, please refer to Appendix # 4

The remote connection on the DVR uses 8 data bits, 1 start bit, and 1 stop bit, no parity. Below is a list of the control codes.

FUNCTION	CODE	ASCII	FUNCTION	CODE	ASCII
KEY_MENU	0x4D	M	KEY_PLAY	0x50	P
KEY_SEARCH	0x73	s	KEY_DOWN	0x4E	N
KEY_ENTER	0x0D	ENTER	KEY_RIGHT	0x52	R
KEY_QUAD	0x51	Q	KEY_KEY_LOCK	0x4B	K
KEY_POP	0x5A	Z	KEY_CH1	0x31	1
KEY_PIP	0x70	p	KEY_CH2	0x32	2
KEY_SLOW	0x53	S	KEY_CH3	0x33	3
KEY_REC	0x72	r	KEY_CH4	0x34	4
KEY_LEFT	0x4C	L	TIMER REC PROCEED	0X54	T
KEY_UP	0x55	U			

APPENDIX #7 – RECORDING TIME (IN HOURS)

The Recording Time is based on Recording Speed, Recording Quality and Recording Mode. The table below is based on a 250GB HDD (maximum capacity).

HDD Type		250 GB					
IPS		30	15	8	4	2	1
MULTI- PLEX	Best	50hr	100hr	187hr	375hr	750hr	1500hr
	High	62hr	125hr	235hr	468hr	937hr	1875hr
	Normal	100hr	200hr	375hr	750hr	1500hr	2998hr
	Basic	167hr	333hr	625hr	1250hr	2498hr	4996hr
QUAD- FIELD	Best	48hr	95hr	178hr	356hr	712hr	1425hr
	High	59hr	118hr	223hr	445hr	890hr	1781hr
	Normal	95hr	190hr	356hr	712hr	1425hr	2848hr
	Basic	158hr	316hr	594hr	1187hr	2373hr	4746hr
QUAD- FRAME	Best	24hr	48hr	89hr	178hr	356hr	713hr
	High	30hr	59hr	112hr	223hr	445hr	890hr
	Normal	48hr	95hr	178hr	356hr	713hr	1424hr
	Basic	79hr	158hr	297hr	594hr	1187hr	2373hr

APPENDIX #8 – NETWORK APPLICATION

IP Video Router/Controller (Web Server) Features

- Compatible with most CCTV Products; empower any video output device watching and controlling on the Internet or LAN
- Auto Network Reconnection (ANR)
- Upgrade firmware & AP from FTP site via Video Router/Controller
- Watch dog function supported
- Support Dynamic IP address
- 4 alarm inputs supported
- Duplex function, record and playback simultaneously at client site
- Auto e-mail warning system which will remind you if external alarm happened
- Intelligent non-stoppable recording function after ANR
- Multi AP screens supported
- Unique video player



IP Video Router
(sold separately)

DVR Control

- 1) Connect the Sub-D plug of the IP Video Router/Controller to one of DVR products (L124-A Model). See connection diagram below

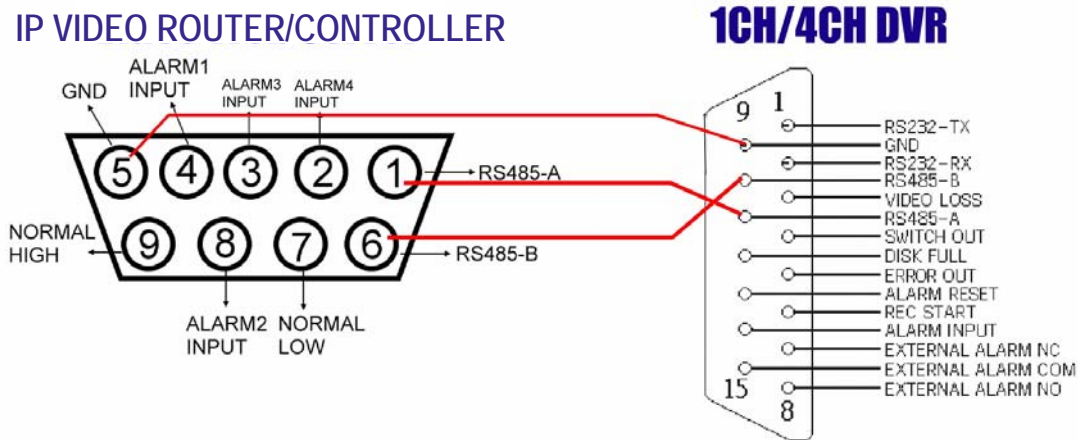

- In the Menu mode on the DVR, set to the "Remote" function. Once in the Sub-Menu you'll need to set-up as follows below:

NOTE : Remote mode : RS-485, Baud rate : 2400, ID : same as "I/O port setting" on the IP Video Router/Controller.

1/4 CH DVR

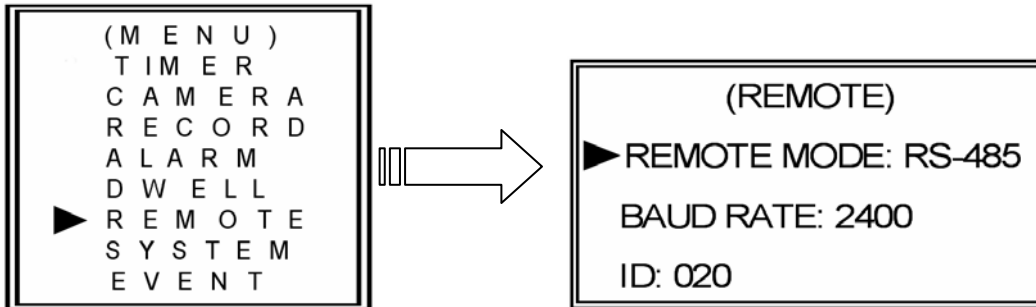

- Set the "I/O Port Setting" in the system configuration of the IP Video Router/Controller. Port1 : DMR-4, Device ID : 20.

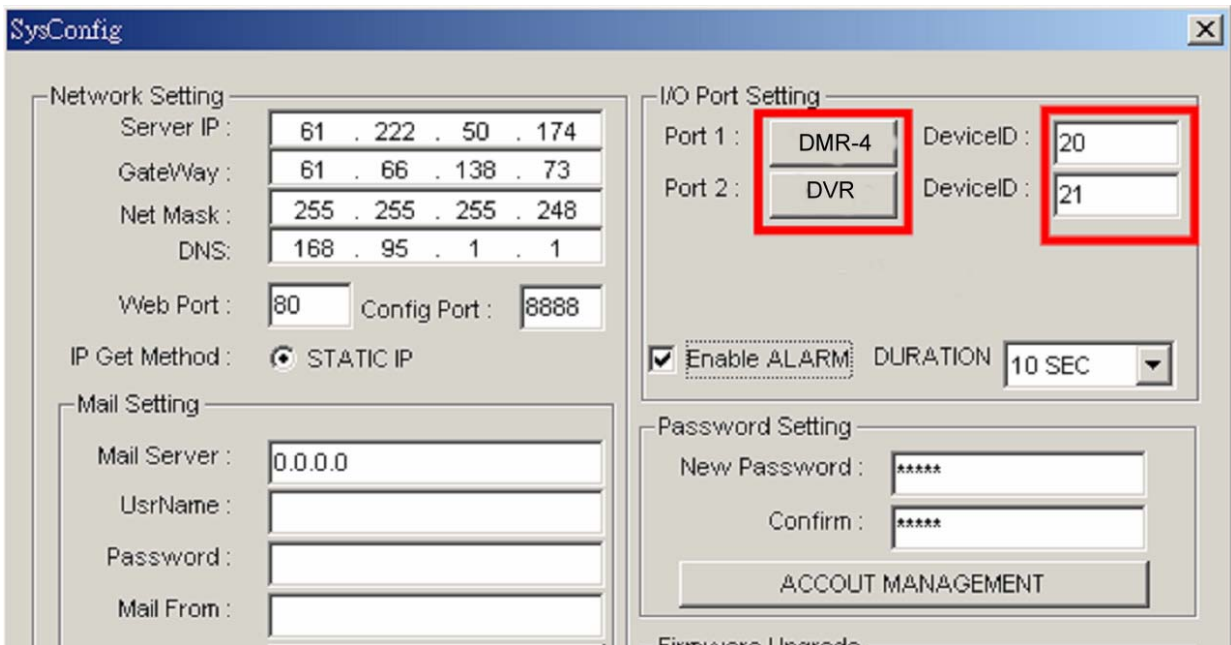

CARE AND MAINTENANCE:

Please follow these instructions to ensure proper care and maintenance of this system

Keep your monitor and camera dry. If it gets wet, wipe it dry immediately.



Use and store your unit in normal temperature environment. Extreme temperatures can shorten the life of the electronic devices.



Handle the monitor carefully. Dropping it can cause serious damage to the unit.



Occasionally clean the unit with a damp cloth to keep it looking new. Do not use harsh chemicals, cleaning solvents, or strong detergents to clean the unit.



Keep the unit away from excessive dirt and dust. It can cause premature wear of parts.

SENTINEL
CCTV

FOR MORE INFORMATION
WWW.SENTINELCCTV.COM