

OWNER'S MANUAL

Palsonic

**68CM CORDLESS REMOTE COLOUR TELEVISION
MODEL: 6850PF**



Type Tested
Electrical
Safety

AS/NZS 3250 Lic 4166
Standards Australia
APP No: N15899

**PALSONIC CORPORATION PTY LTD
1 JOYNTON AVENUE
WATERLOO NSW 2017 AUSTRALIA
TEL: (02) 9313 7111
FAX: (02) 9313 7555
www.palsonic.com.au**

**PALSONIC CUSTOMER SERVICE
TELEPHONE
AUSTRALIA: 1300 657 888**

Contents

Congratulations on your purchase of this Palsonic colour television.

We recommend that you thoroughly read this manual before use to fully enjoy the many functions and excellent effects of this equipment.

Retain this manual in an easily accessible location for future reference.

* Screen displays and illustrations in this manual may differ from the actual ones for better visibility.

Contents

| | |
|---|----|
| Important Safety Cautions | 2 |
| Identification of Controls | 4 |
| Front View | 4 |
| Back View | 4 |
| Remote Control | 5 |
| Installation | 6 |
| Antenna installation | 6 |
| Installing batteries | 7 |
| Effective range of the Remote | 7 |
| Connections | 8 |
| To connect to AV input terminals | 8 |
| To connect DVD input terminals | 9 |
| To connect to AV output terminals | 9 |
| Turning on/off | 10 |
| Tuning In | 11 |
| Menu Operations | 11 |
| Channel Preset | 11 |
| Channel Selection | 15 |
| Picture and Sound Adjustment | 16 |
| Clock Setting | 18 |
| Setting System | 19 |
| Playing Game | 20 |
| Other Functions | 21 |
| Troubleshooting Guide | 23 |
| Specifications | 24 |

Important Safety Cautions

Safety Cautions

- ◆ *When any unusual situation occurs, turn off the power supply at once and remove the plug from the wall outlet. Contact a qualified service department in your local area.*

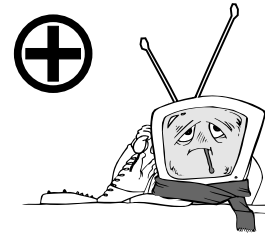

- ◆ *Do not expose the TV set to rain or excessive moisture. Avoid using the set in very warm or damp places and never use it in a bathroom.*



- ◆ *When cleaning dust off the picture tube disconnect the power first. You can wipe lightly with a piece of dry, clean and soft cloth.*

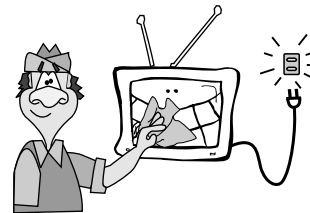

- ◆ *Avoid exposing the set to direct sunlight and other sources of heat to prevent damage to the cabinet and components.*

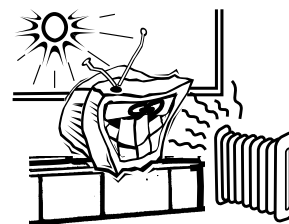

- ◆ *High voltage exists in this TV set. Do not remove the cover.*



! This TV set can operate on a power of ~240V, 50Hz. You must not use a power supply of any other type.

◆ Do not cover the ventilating hole in the cabinet
Keep a space of more than 10cm from the walls to the TV set to ensure adequate ventilation.

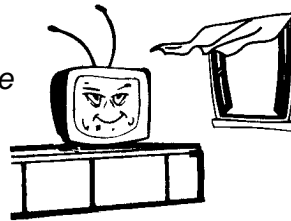

◆ If the power cord or the plug is damaged contact a qualified service department for service.

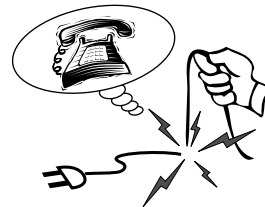

◆ When the TV set is to be left unattended for a long period of time, turn off the power supply and remove the plug from the wall outlet.

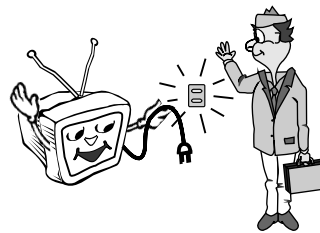

◆ Don't try to push anything into the cabinet or place any vessel with water on the TV set.

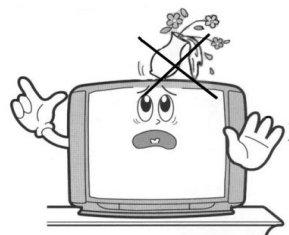

◆ Don't overload wall outlets; extension cords, or integral convenience receptacles as this can result in a risk of fire or electric shock.

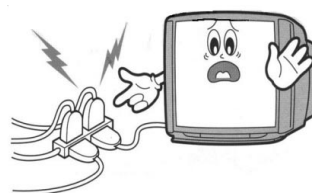

Identification of Controls

Front View

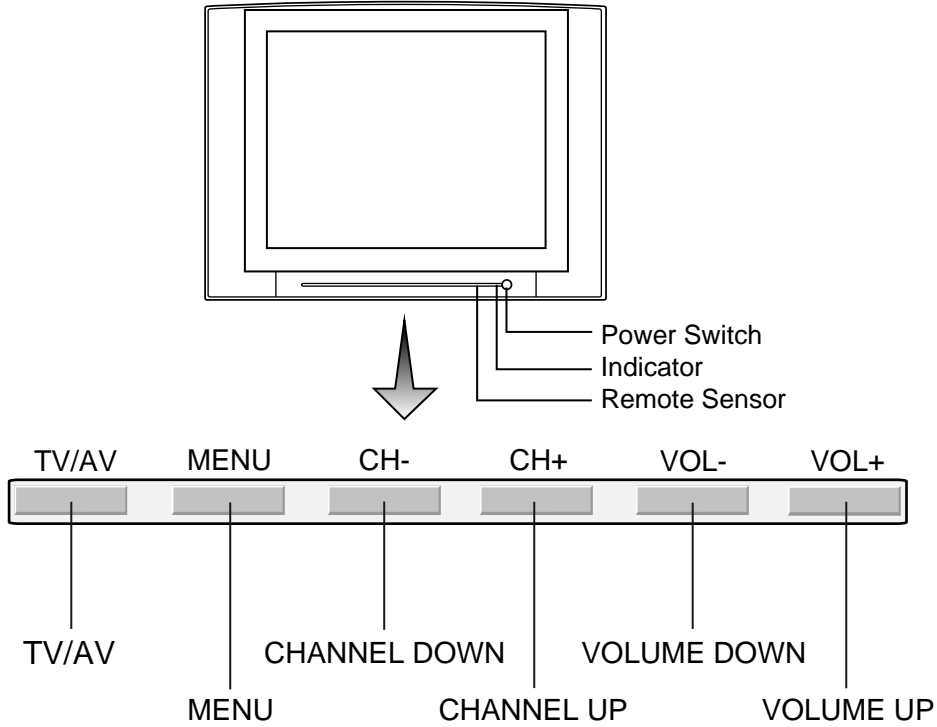

Back View

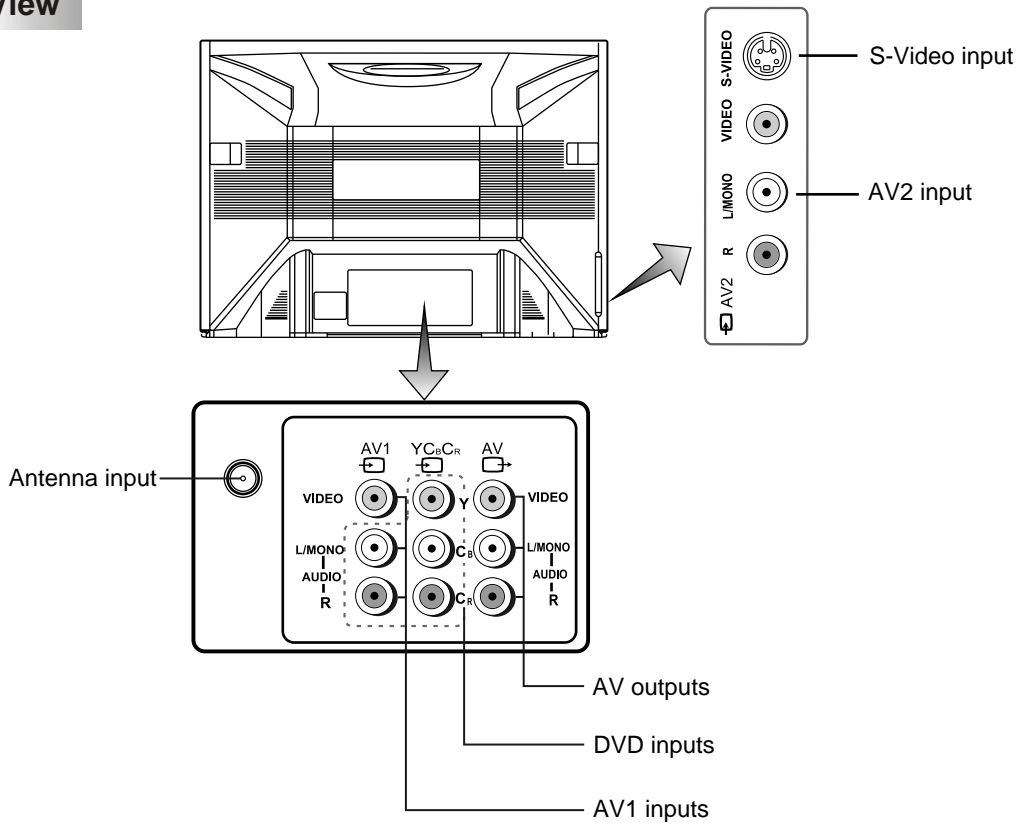

Remote Control

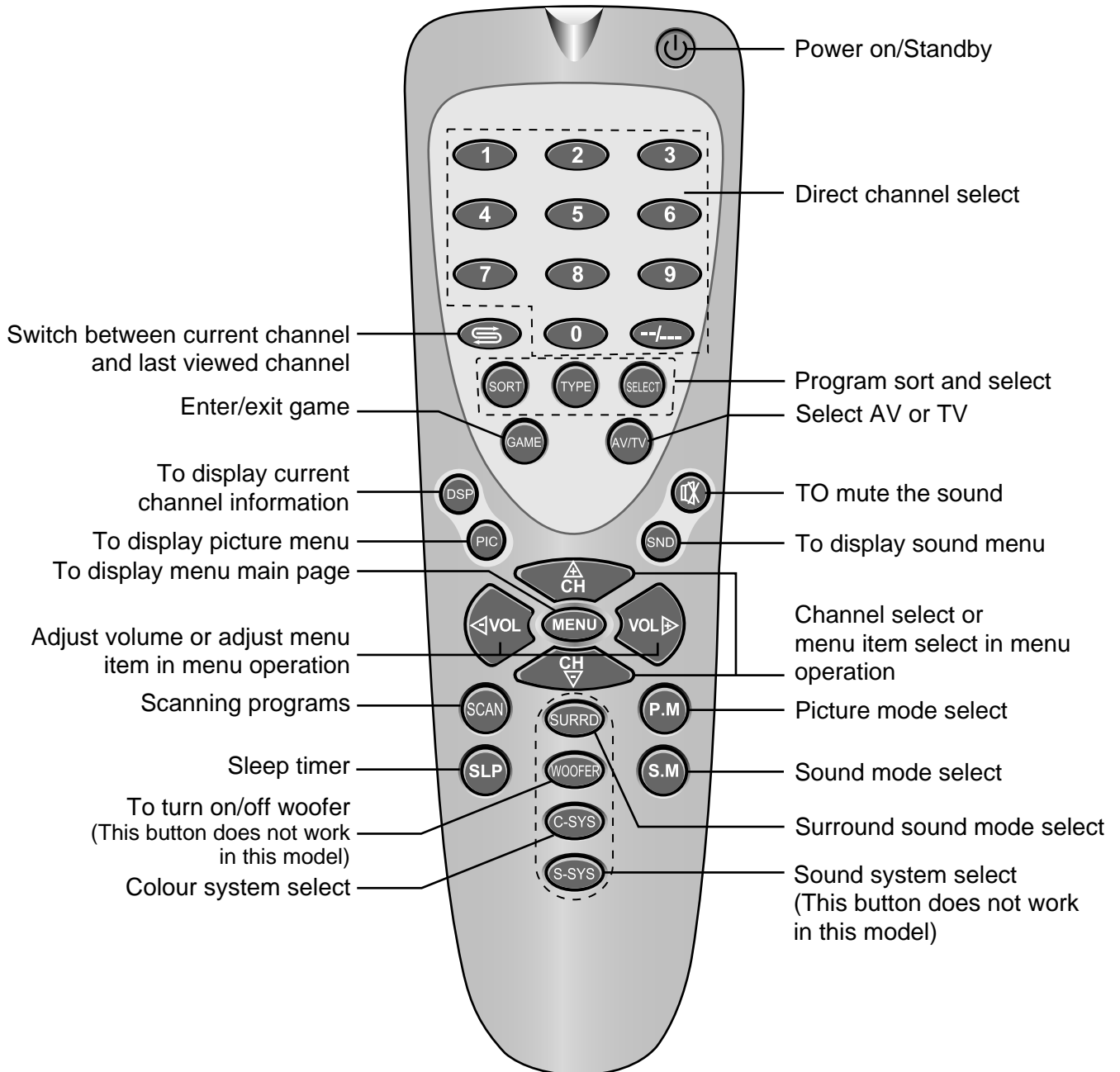

Installation

INSTALL the unit in a room where direct light will not fall upon the screen. Total darkness or a reflection on the picture screen may cause eyestrain. Soft and indirect lighting is recommended for comfortable viewing.

Antenna installation

Optimum reception of colour requires a good signal and will generally mean that an outdoor antenna must be used. The exact type and position of the antenna will depend upon your particular area.

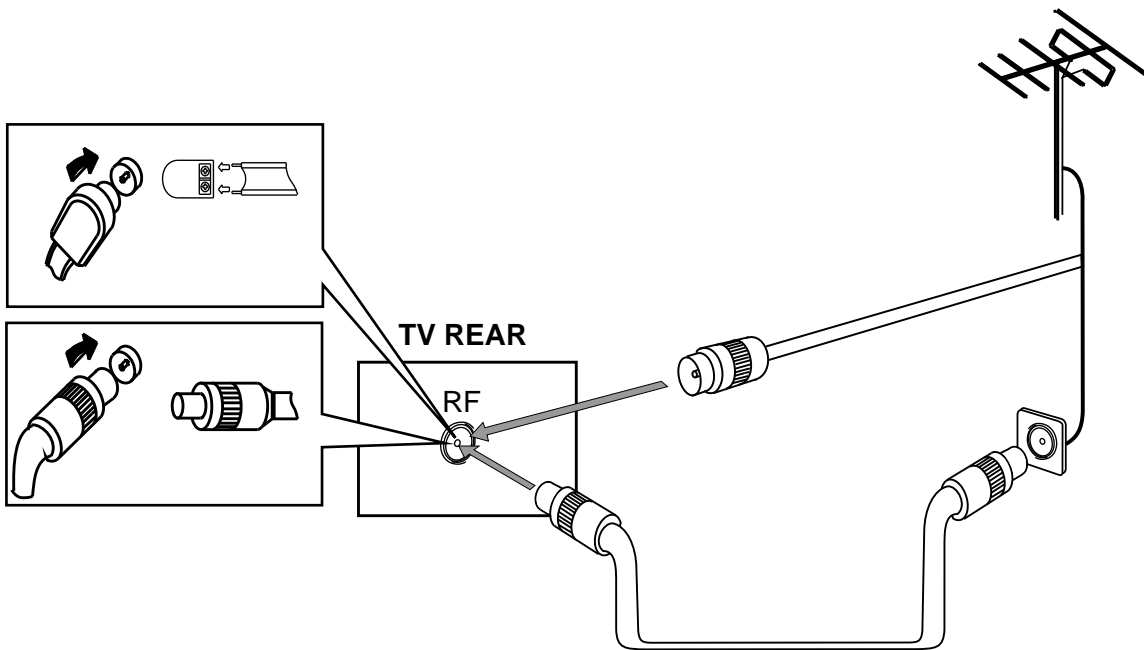

! Notes:

- It is recommended that the 75-ohm coaxial cable be used to eliminate interference and noise which may occur due to radio wave conditions.
- The aerial cable should not be bundled with the power cord and the like.

Installing batteries

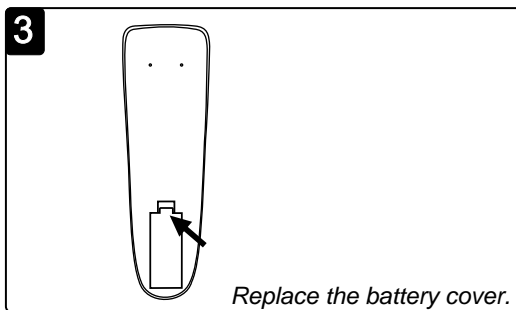
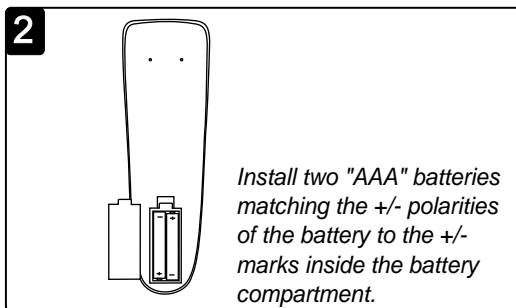
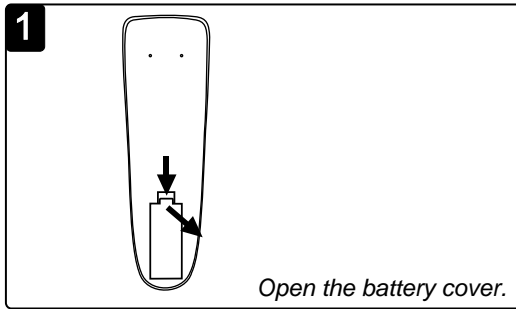

! Notes:

- The battery life should be about one year under normal life. Do not try to recharge batteries not intended to be recharged.
- Use only the size and type of batteries specified. Do not mix different types of batteries together or old batteries with fresh ones.
- When the remote control will not be used for a long period of time or when the batteries are worn out, remove the batteries.
- Do not throw the batteries into a fire. Dispose of used batteries in the specified manner.
- Do not drop, dampen or disassemble the remote control.

Effective range of the Remote

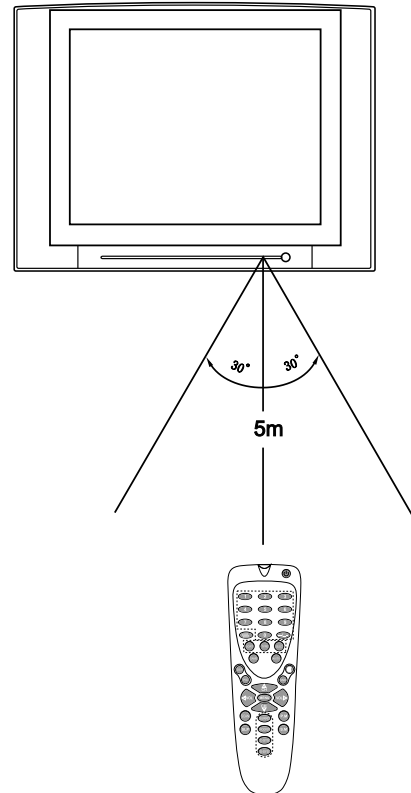

! Notes:

- When there is an obstacle between the TV and the transmitter, the transmitter may not operate.
- When direct sunlight, and incandescent lamp, fluorescent lamp or any other strong light shines on the REMOTE SENSOR of the TV the remote operation may be unstable.

Connections

To connect AV input terminals

You can connect video equipments such as a VTR and video camera to this TV and enjoy the high quality picture and sound.

If your video equipment has a S-VIDEO output terminal, connect it to the S-VIDEO input terminal (special S-VIDEO type) of the unit. If not, connect it to the VIDEO terminal (RCA).

The S-VIDEO and AV2 use the same group of audio input terminals, and the S-VIDEO input terminal has priority over the AV2 VIDEO terminal. To use equipment connected to the VIDEO terminal, disconnect any plug from the S-VIDEO terminal.

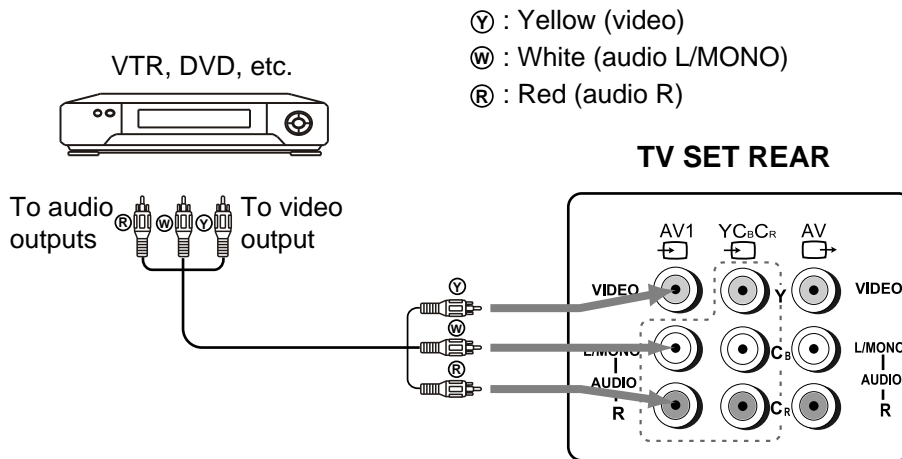
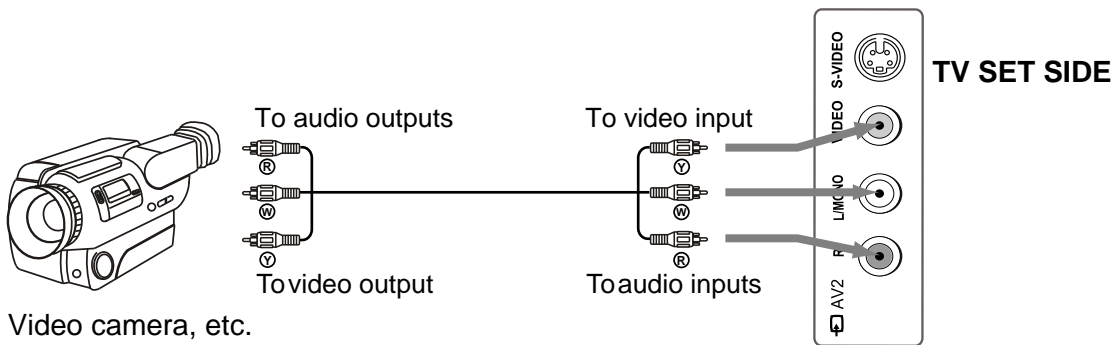

You press the **AV** button on remote control to select input signal. Every press of this button, the screen displays as the following sequence:

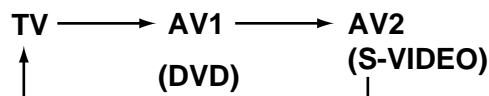

To connect DVD input terminals

The figure below shows how to connect the DVD input terminals of the TV set to the DVD Player, Laser Disk Player, etc

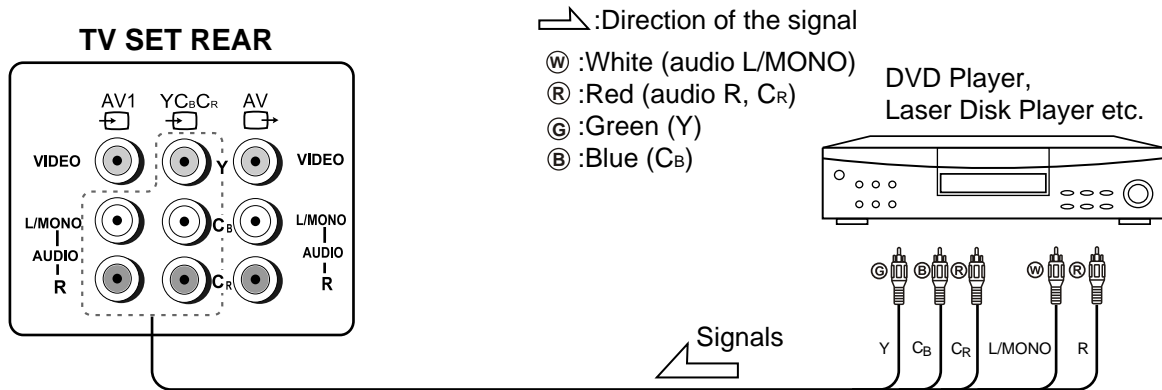

! Notes:

1. Both the C_R terminal and the audio R terminal are red for easy identification. Make sure they are correctly connected.
2. DVD and AV1 use the same group of audio input terminals.
3. DVD has priority over AV1. If use AV1 input, disconnect DVD.

To connect AV output terminals

You can connect a stereo system to the audio output terminals (RCA) on the set to enjoy a high quality sound from the stereo system. You can also connect the AV output terminals to VTR to record TV programs being displayed on the screen.

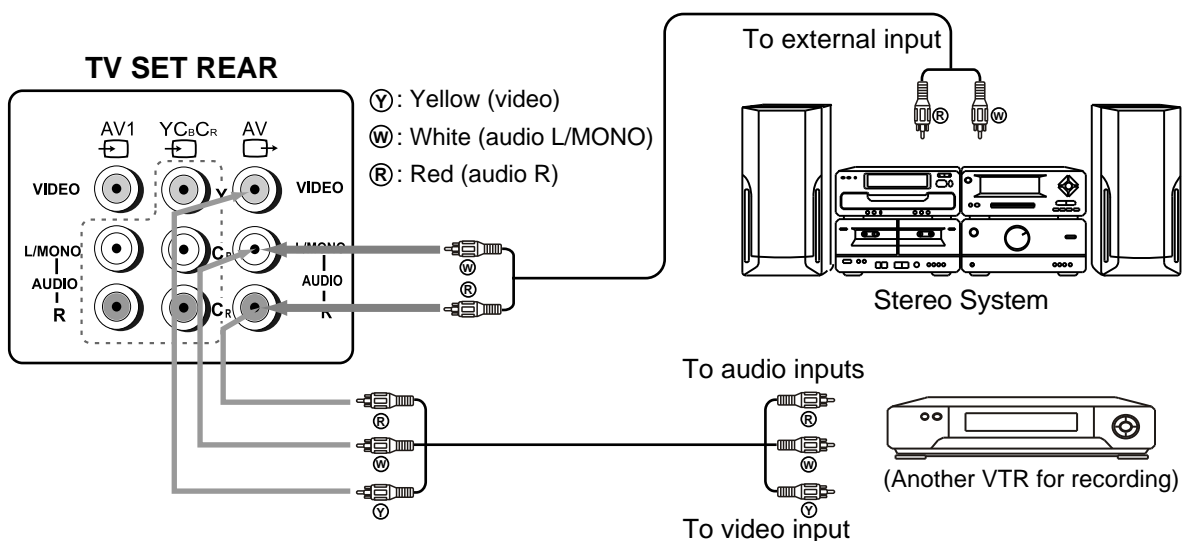

Turning On/Off

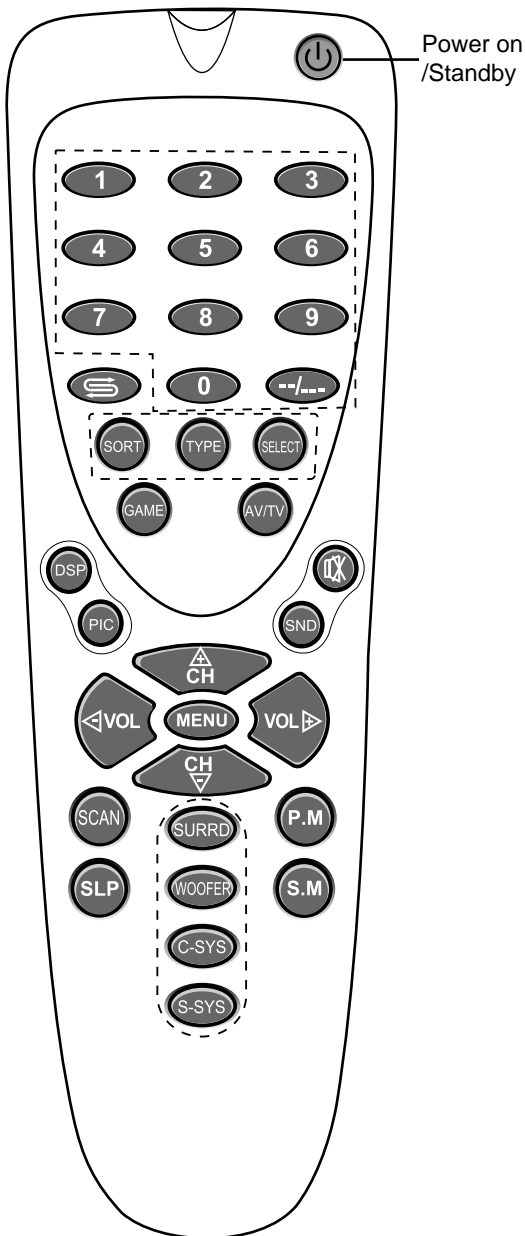

Turning On

- 1 Insert the **Power cord** into the wall outlet, press the **Power Switch**, the unit goes to **STANDBY** mode.
- 2 Press the **CH+/-** on the unit, or press any one of the **⏻** button, **CH+/-** or **0-9** buttons on the remote control to turn it on.

! Notes:

If there is no TV input signal, then a blueback appears. After 10 minutes, the set auto goes to **STANDBY**.

Turning Off

- 1 Press the **Power Switch** on the TV set if you want to cut off the power completely.
- 2 If you want to turn off the TV set temporarily, press the **⏻** button on the remote control.

! Notes:

If you turn off the power, the unit memories the last status including picture and sound settings and preset channels. Next time when you turn on, the unit works in the memorised status.

The TV set can turn off automatically by:

- A. **Sleep** timer function (needs to be set in advance).
- B. **OFF** timer function (needs to be set in advance).

Tuning In

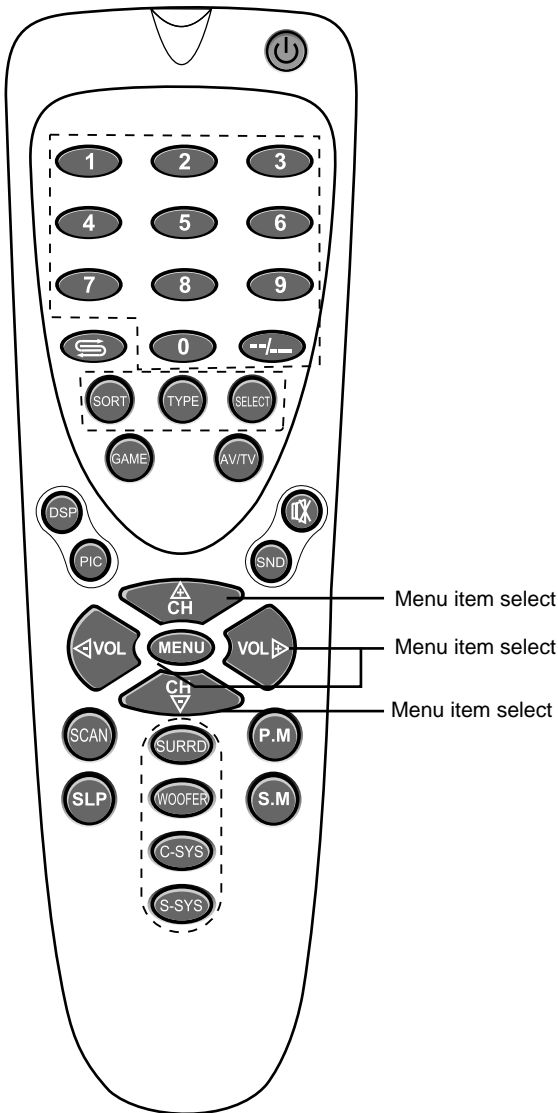

Menu Operations

Press the **MENU** to access the menu main page. Press the **MENU** repeatedly to select a sub-menu page. Use **CH+/-** to select menu item or **VOL+/-** to adjust the value of menu item. Press **DSP** or wait for approx. 10 seconds without any operation to exit menu.

Channel Preset

The unit provides two ways for you to preset channels: Auto Search and Manual Search.

1 Access the PRESET menu page.

Press the **MENU** repeatedly to display the PRESET menu page.

Note: If the **CHILD LOCK** is set to **VALID**, the **PRESET** menu page can not be accessed. Please refer to Page 21 **Setting CHILD LOCK**. In AV mode, the **PRESET** menu page can not be accessed.

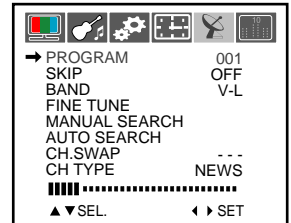

2 Auto Search

2.1 Press **CH+/-** to select **AUTO SEARCH** item.

2.2 Press **VOL+/-** to start Auto Search. All active channels will be preset and stored into the memory automatically. After auto search, the TV will go to the first channel.

2.3 During the process of Auto search, pressing **MENU** will stop the process.

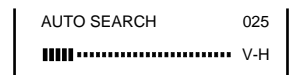

Note: please set the **COLOR SYSTEM** to **AUTO** before you start **AUTO SEARCH**.

Tuning In

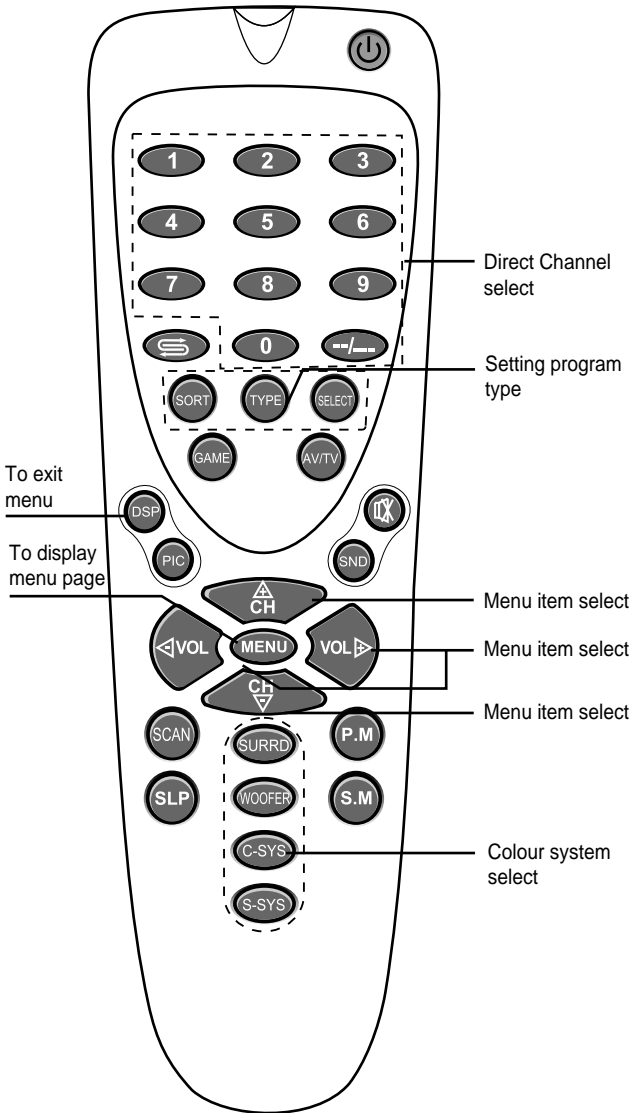

6 The setting system

If the picture's colour is abnormal, press the **C-SYS** button to select a proper colour system. Every press of this button, the colour system changes as follows:

AUTO → PAL → N3.58 → N4.43

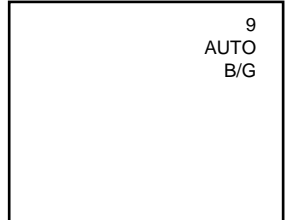

Note: You may also use the **SYSTEM** menu page to set the colour system.

In this model, you needn't adjust the sound system.

7 Channel Swap

You may use this function to edit the program order according to your preference.

From the **PRESET** menu page, press **CH+/-** to select **CH.SWAP** item and use **0-9** buttons to input the target channel number, then press **VOL+/-** to swap contents of current channel and the target channel.



Note: if the **CHILD LOCK** is **VALID**, the **SWAP** function does not work.

8 Sorting Programs

You may sort all programs into **NEWS**, **SPORT**, **ECONOMICS** and **TELEPLAY**.

Method 1: Use **CH+/-** or **0-9** buttons to select a channel number, press **TYPE** to sort this channel's program. Every press of this button, the program type changes as:

TELEPLAY → NEWS → SPORT → ECONOMICS

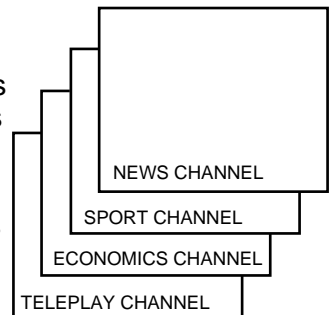

Method 2: From the **PRESET** menu page, select a channel number and then press **CH+/-** to select **CH TYPE** item, press **VOL+/-** to select a program type.



Channel Selection

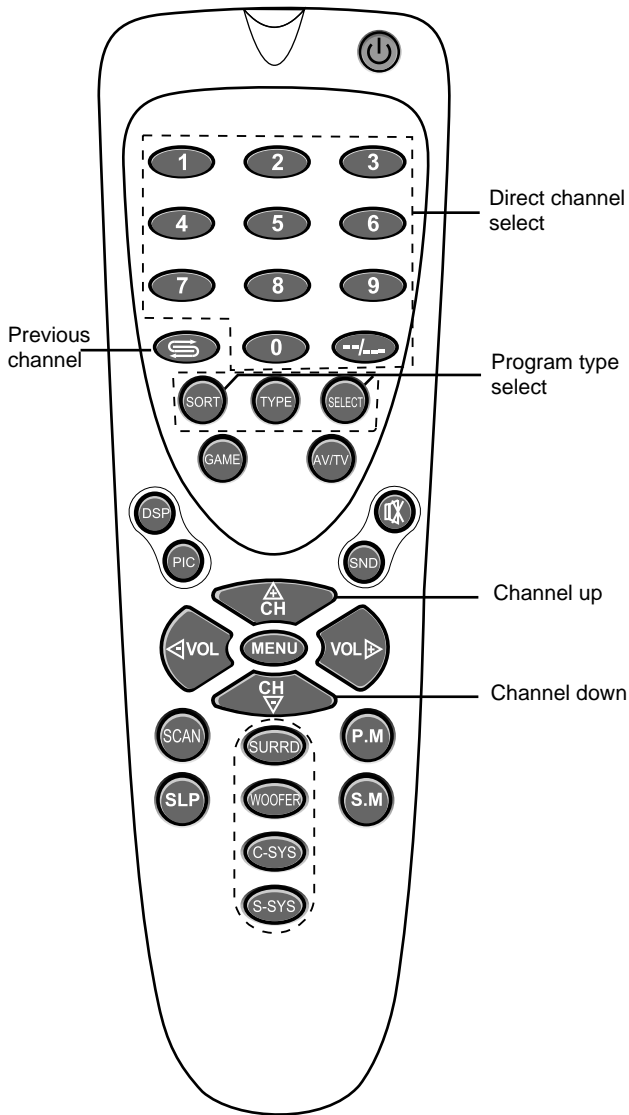

1. Using number buttons

Select one-digit channel number



Select two-digit channel number

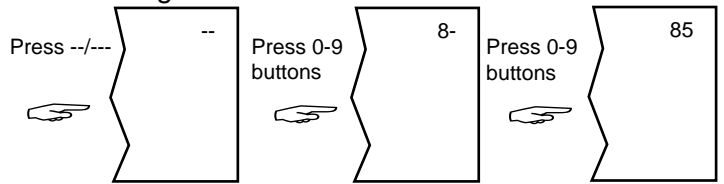

Select three-digit channel number

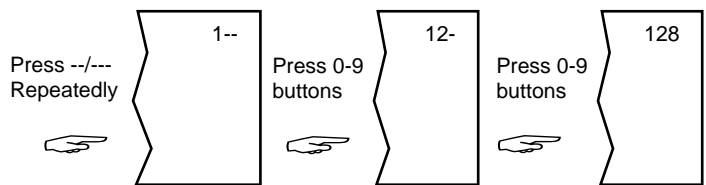

Note:



If you select a two-digit or three-digit channel the period of two-press should be within 2 seconds.

2. Using CH+/- buttons

Press **CH+** the channel number increases; Press **CH-**, the channel number decreases.

3. Using previous channel buttons

Press  button to switch between the current channel and the previous channel.

For example, the channel you previously watched is 11, the current channel is 2, press the  button, it will return to channel 11, press the  button again it will return to channel 2.

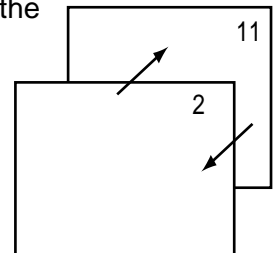

4. Selecting channel according to program type

Press **SORT** button to select a program type you want to view and press **SELECT** button to select channels within this program type group.

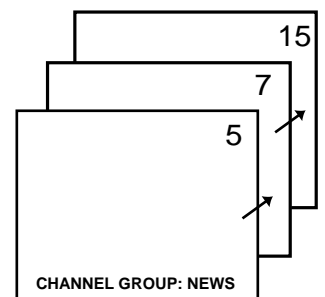

Picture and Sound Adjustment

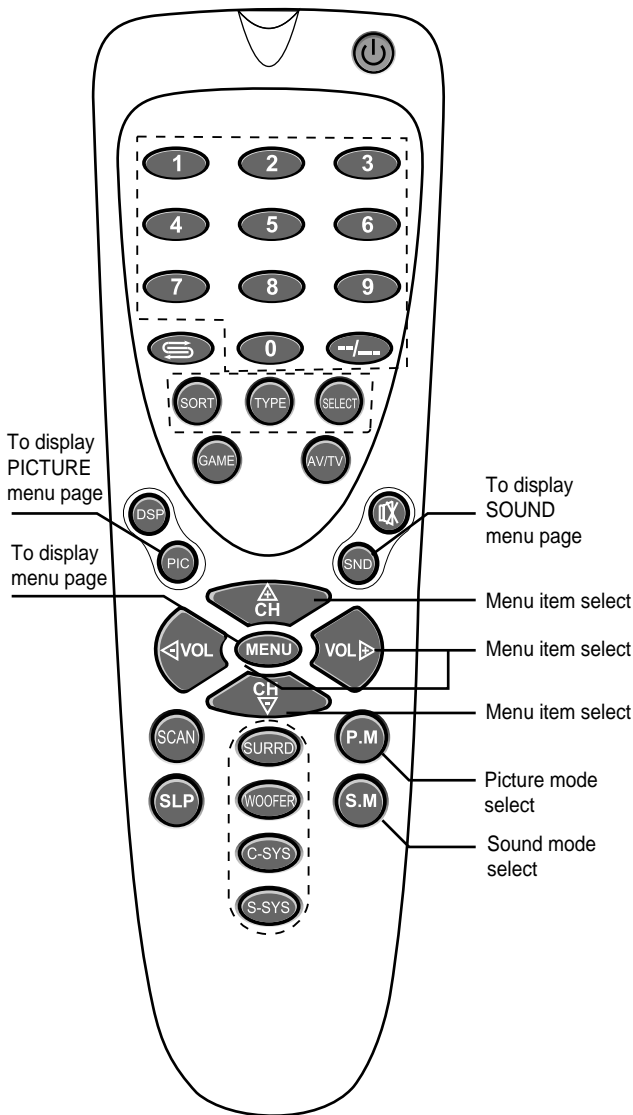

1 Picture adjustment

Press P.M button to quickly select picture mode as **COLORFUL, MILD, STANDARD, NATURE** and **CUSTOM**.

You may follow these steps to adjust picture according to your preference.

Press **PIC** button repeatedly to select a desired item you want to adjust, then press **VOL+** or **VOL-** to adjust it.

| Item | Press | |
|------------|----------|----------|
| | VOL- | VOL+ |
| BRIGHTNESS | Darker | Lighter |
| CONTRAST | Weaker | Stronger |
| COLOR | Paler | Deeper |
| SHARPNESS | Softer | Sharper |
| TINT* | Purplish | Greenish |

* The TINT item is for NTSC only.

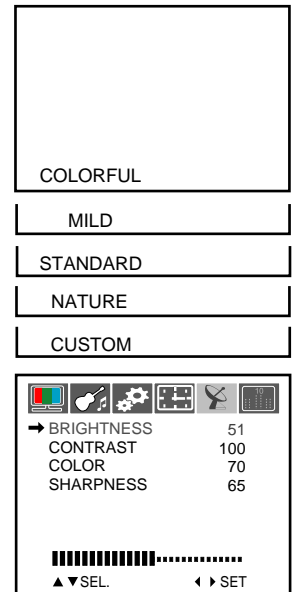

2 Adjusting volume and muting the sound

Press **VOL+/-** to adjust volume.

If you want to mute the sound, press the **MUTE** button on the remote control.

To restore the sound, press this button again or **VOL+/-**.

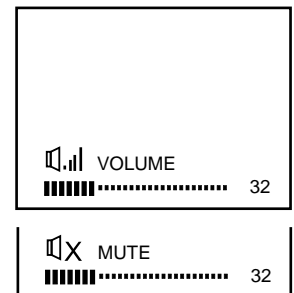

3 Sound mode

The unit provides five sound modes for your choice. Press **S.M** button to select a desired sound mode. You may also press **SND** or **MENU** button to enter **SOUND** menu page, press **CH+/-** to select **SUD MOD** item and press **VOL+/-** to select a desired sound mode from **SPEECH, MUSIC, MOVIE, STANDAR** or **CUSTOM**.

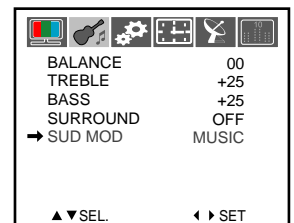

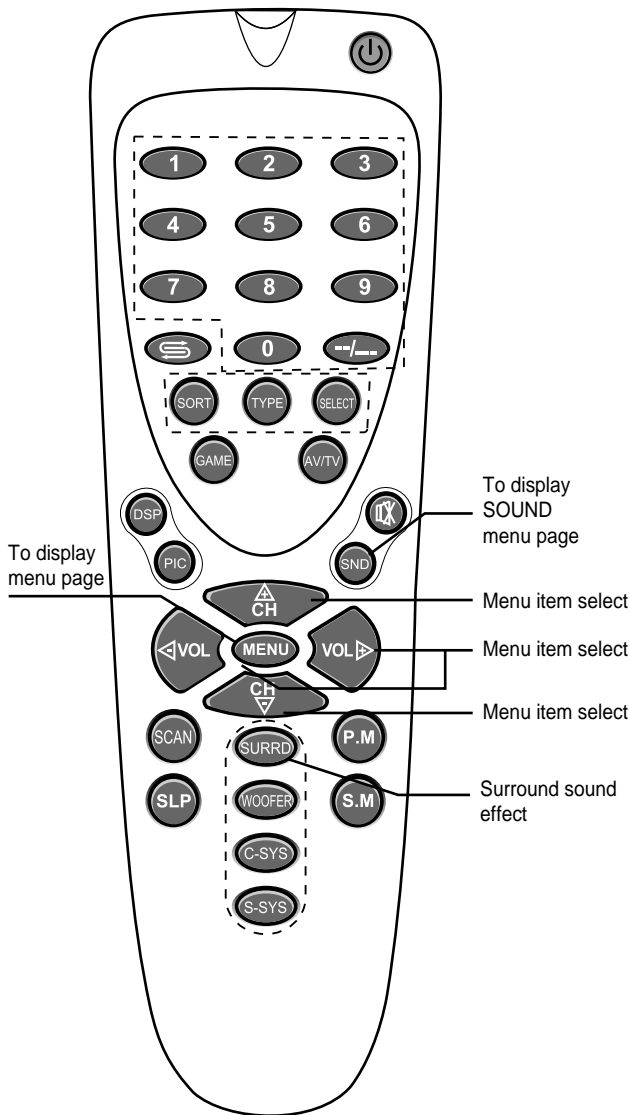

| Mode | Sound quality |
|--------|--|
| SPEECH | Suitable for listening to news/dialogue. |
| MUSIC | Like a music hall filled with a rich warm sound. |
| MOVIE | Like a movie theatre filled with a dynamic sound |
| STANDA | Standard sound |
| CUSTOM | The sound quality you set. |

If you want to adjust sound to your desired status, press **SND** button repeatedly to select a item you want to adjust and press **VOL+/-** to adjust. Your adjustments will be memorised.

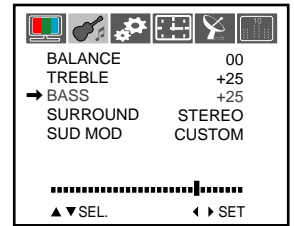

4 To enjoy surround sound

When viewing TV programs, press **SURRD** button to select **OFF** or **STEREO**; When viewing programs from AV inputs, press **SURRD** button to select **STEREO**, **LOW** or **HIGH**. You may also use the **SOUND** menu page to select a surround sound effect.

The **STEREO** effect is for TV programs or mono AV programs only. You may select a proper surround sound effect according to the input mode or program's contents.

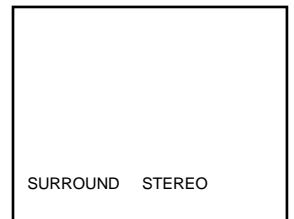
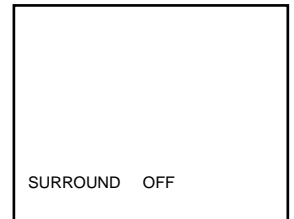

Clock Setting

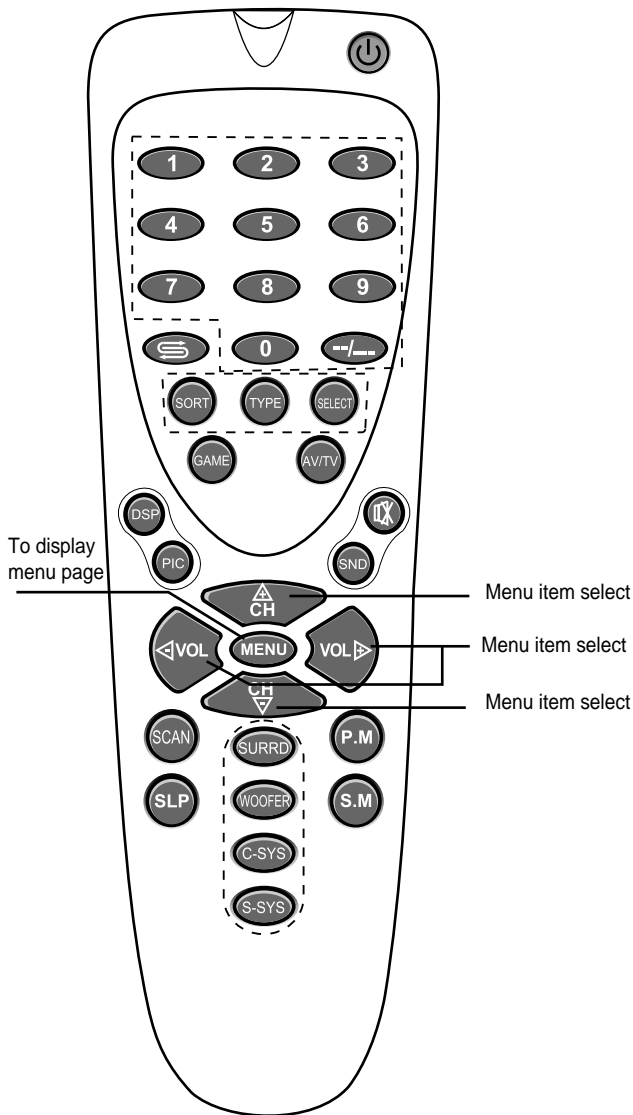

Clock Setting

Press **MENU** repeatedly to display **CLOCK** menu page

Note:

Before you perform any timer settings, you need to set current time firstly. If you fail to set current time, your timer settings is invalid.

1 Setting current time

From the **CLOCK** menu page, press **CH+/-** to select **TIME** item. You need to set hour and minute: use **VOL-** to set hour from 0-23; use **VOL+** to set minute from 00-59.

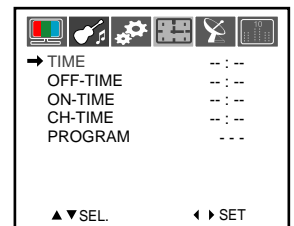

2 Off timer

From the **CLOCK** menu page, press **CH+/-** to select **OFF-TIME** item and refer to step 1 to set hour and minute. The TV goes to **STANDBY** at the designated time and at the same time cancel your off timer setting. Next time if you want to use this function, you need to set the off timer again.

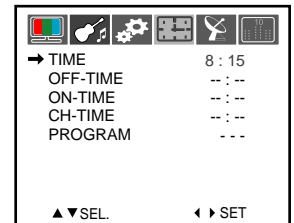

3 On timer

From the **CLOCK** menu page, press **CH+/-** to select **ON-TIME** item and refer to step 1 to set hour and minute. Now you have finished setting the current time and turn-on time.

If the TV is in **STANDBY**, it turns on automatically at the designated time and at the same time cancel your on timer setting. Next time if you want to use this function, you need to set the on timer again.

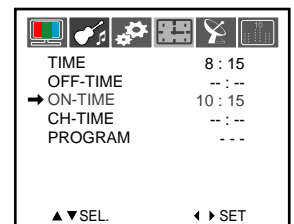

4 Preengage Channel

The function enables you to set a certain time and channel in advance, so that the TV goes to your preset channel at the designated time.

From the **CLOCK** menu page, press **CH+/-** to select **CH-TIME** item and refer to step 1 to set hour and minute. Press **CH-** to select **PROGRAM** item and input a channel number by using **0-9** buttons (or you may adjust channel number through **VOL+/-**). The TV goes to the specified channel at the designated time.



System Setting

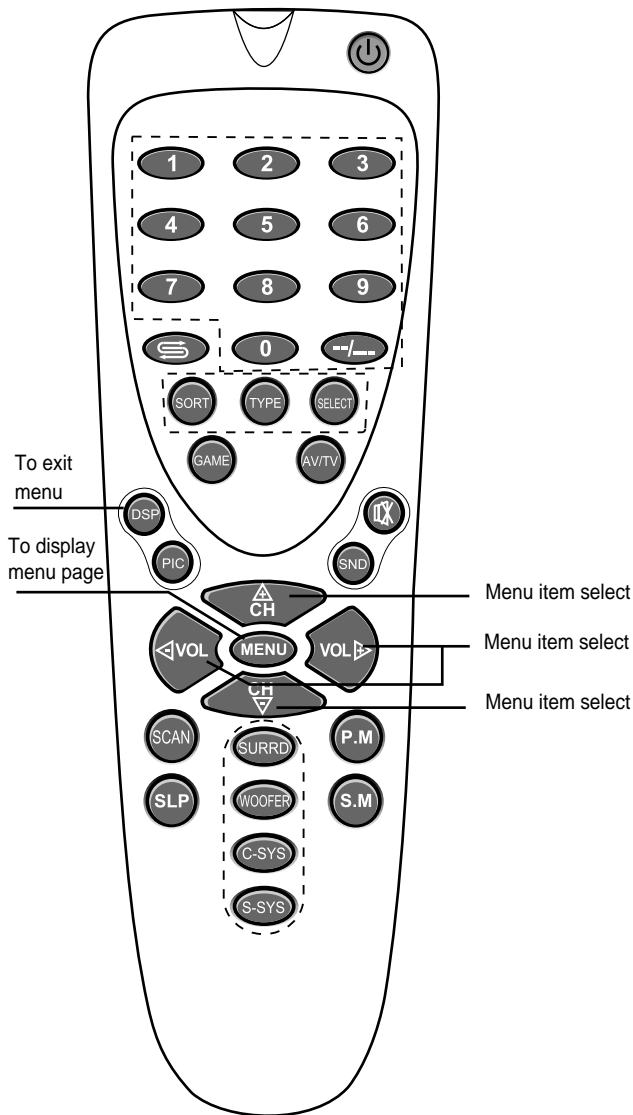

System setting

Press **MENU** repeatedly to display **SYSTEM** menu page.

1 Setting black background

From the **SYSTEM** menu page, press **CH+/-** to select **BLACK BACK** item. Press **VOL+/-** to select **ON** or **OFF**. If **ON** is selected, the screen is black and the unit goes to screen saving mode when no signal is received (in TV mode only).

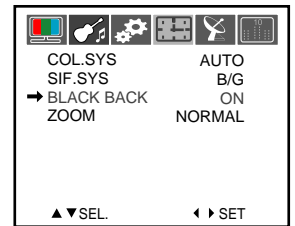

2 ZOOM mode

From the **SYSTEM** menu page, press **CH+/-** to select **ZOOM** item. Press **VOL+/-** to select **NORMAL** or **ENLARGE**. The **ENLARGE** mode is for you to view movie or 16:9 format programs.

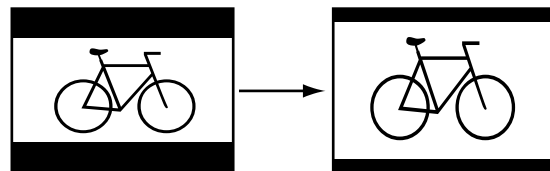
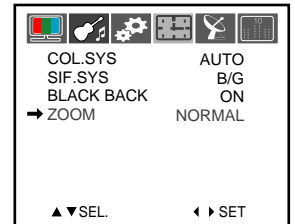

3 Colour system

From the **SYSTEM** menu page, press **CH+/-** to select **COL.SYS** item. Press **VOL+/-** to select a proper colour system.



Note: This function is as same as the C-SYS button on the remote control.

Playing Game

Game introduction

There is a built-in game (Falling cube) for you to play.
Press **GAME** button to access game interface.

On the screen, there are falling cubes. Pressing **MENU** button can rotate the falling cube. Pressing **VOL+/-** buttons can move the falling cube right or left while pressing **CH-** button can hasten the falling speed of the cube.

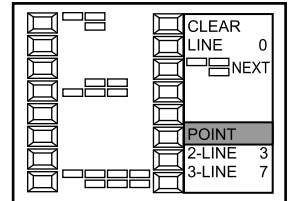

When one row has been filled with the cubes, the row will disappear, and your mark will gain one point. If two rows disappear at the same time, your mark will gain three points. If three rows disappear at the same time, your mark will gain seven points.

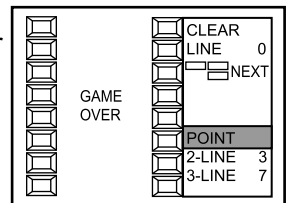

The right window provides hints about next cube's shape, you can arrange current cube's position and angle in advance.

When the cubes reach to top, the screen will display **GAME OVER**, and the game is finished.

To exit the game, press **GAME** button. If you want to restart the game when the game is finished, you should exit the game firstly, then access and start the game again.

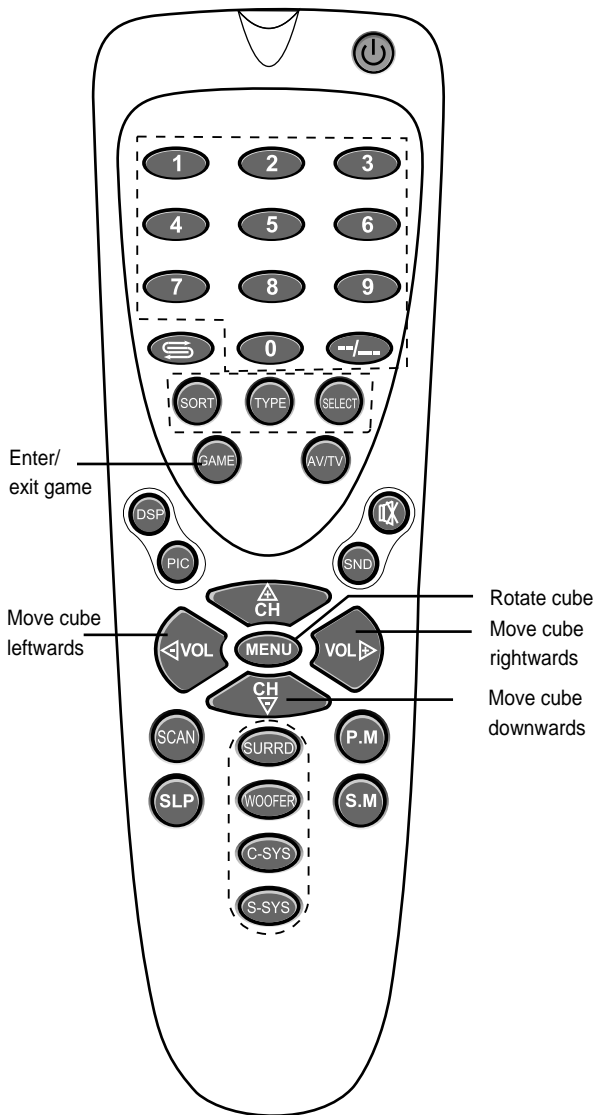

Other Functions

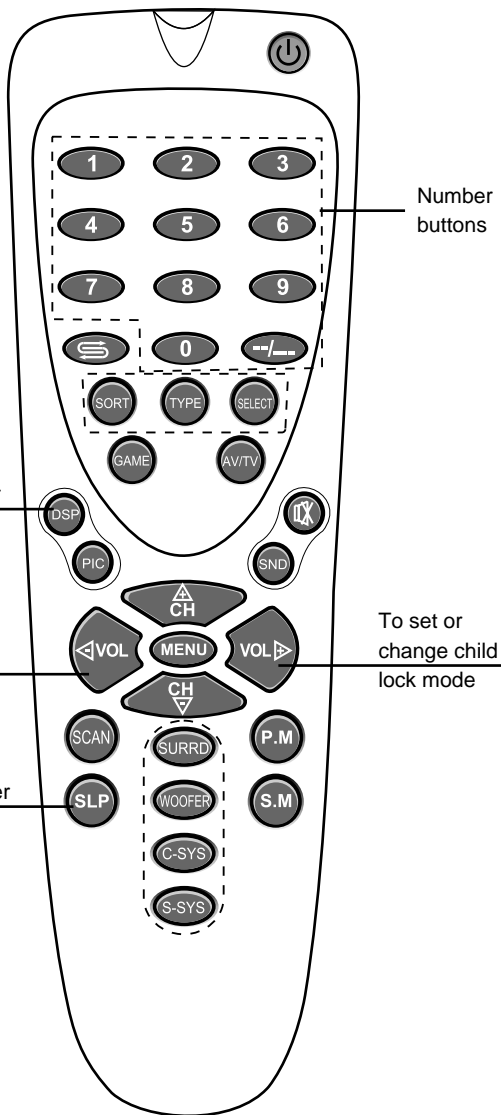

1 Setting Child Lock

Before you enter child lock mode, please select the channel you want to set child lock.

1.1 Entering Child Lock mode

Press and hold **DSP** button until the screen displays "**PASSWORD - - - -**" then input the password to enter into **Child Lock** mode (the default password is **0000**). Every press of the **DSP** button, the screen displays as follows:

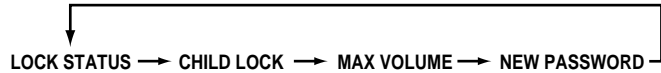
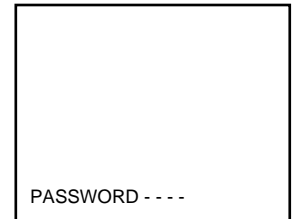

1.2 Setting Child Lock

Before you set child lock, please set **LOCK STATUS** to **VALID** in the **LOCK STATUS** page by using **VOL+/-** (the default status is **INVALID**).

To set **CHILD LOCK** for current channel, press **VOL+/-** to set **CHILD LOCK** to **ON** in the **CHILD LOCK** page. If you want to set child lock for other channels, please select the channel and repeat the above steps to set **CHILD LOCK** separately.

With the **CHILD LOCK ON** (of **OFF**) on the screen, press **DSP** again to display **MAX VOLUME**. This enables you to preset a maximum volume value when the **LOCK STATUS** is set to **VALID**.

If you want to change password, press **0-9** buttons to input a new password in the **NEW PASSWORD** page.

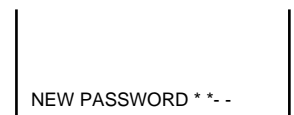
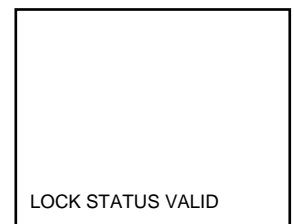

If a locked channel is selected, a red mark  appears on the black screen.

When the **LOCK STATUS** is set to **VALID**, the **PRESET** menu page is inaccessible.

The TV set provides a master password: 8288

2 Sleep timer

Press **SLP** button to select sleep time from 15 to 120 minutes. The TV set goes to **STANDBY** at the designated time. If you want to cancel **Sleep timer**, press the **SLP** button repeatedly to display  90.

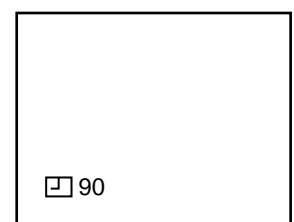

Other Functions

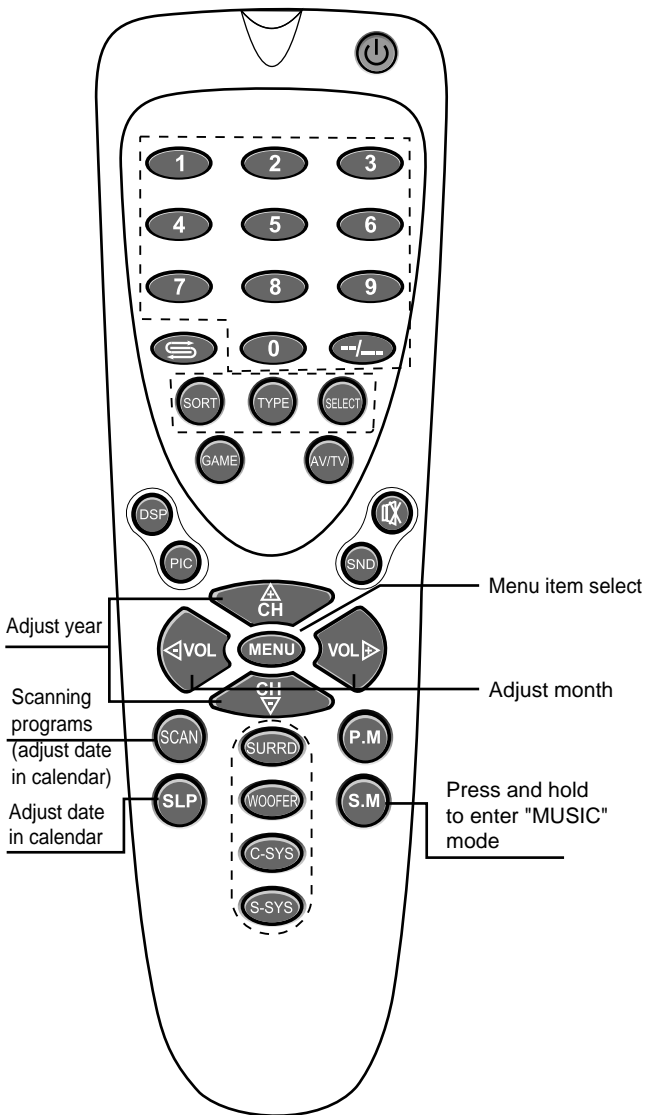

3 Program Scanning

Press **SCAN** button to scan the program from current channel to higher channel one by one. Every program will be scanned and the channel number is displayed on the screen. Each program will be displayed for about 2 seconds.

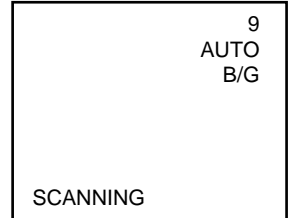

Press any button to stop the process, and the TV will settle at the current scanned program.

4 Calendar (1950-2049)

Press **MENU** repeatedly to display **CALENDAR** page. Use **CH+/-** to adjust year; Use **VOL+/-** to adjust month; Use **SCAN** and **SLP** to adjust date.



5 Music mode

The TV set can serve as an audio system when you are playing CD, VCD or DVD.

If you only want to listen to the music, you may press and hold the **S.M** button for about 5 seconds to enter into "**MUSIC**" mode, the TV screen is black and the sound still works. Press any button on the remote control will exit "**MUSIC**" mode.

In "**MUSIC**" mode, you may play game at the same time while listening to music. If you want to exit "**MUSIC**" mode, you need to exit game firstly.

Troubleshooting Guide

Before calling service personnel, please check the following chart for a possible cause to the trouble you are experiencing.

| Symptoms | Check the following items |
|---|--|
| Power is not turned on. | <ul style="list-style-type: none"> □ Be sure the power cord is plugged in. |
| Poor colour, poor tint. | <ul style="list-style-type: none"> □ Contrast, colour, tint are not correctly adjusted |
| Spots appear on the screen. | <ul style="list-style-type: none"> □ Possible interferences of automobiles, motorcycle, trolley bus, neon lamps, etc. |
| Stripes appear on the screen. | <ul style="list-style-type: none"> □ Possible interference of electronic interference from another TV set, a computer, an electronics game machine, a broadcast station, etc. |
| Double images or "ghosts". | <ul style="list-style-type: none"> □ This may be caused by reflections from nearby mountains or buildings. □ Check the antenna direction. |
| Snowy picture. | <ul style="list-style-type: none"> □ It is possible that the aerial "lead-in" is damaged or comes off. □ Check the antenna direction. |
| Remote controller does not work. | <ul style="list-style-type: none"> □ The batteries may be worn out. □ The batteries may be installed with their polarity reversed. |
| TV cabinet creaks. | <ul style="list-style-type: none"> □ Even if the picture or the sound is normal, changes in room temperature sometimes makes the TV cabinet expand or contract, making a noise. This does not indicate a malfunction. |
| Unevenness in colour in some parts of the screen. | <ul style="list-style-type: none"> □ When the set is switched on, do not shift or move the set around. Sometimes it may develop an unevenness in colour in some parts of the screen. This can be eliminated by switching off the set with the POWER switch and wait for 10 minutes before switching on again. |
| Black screen and PRESET menu is inaccessible. | <ul style="list-style-type: none"> □ It is possible that the CHILD LOCK is in VALID mode. To enter PRESET menu, set LOCK STATUS to INVALID. |
| Black screen but the sound is normal. | <ul style="list-style-type: none"> □ It is possible that the TV set is in music TV mode. |

Specifications

Power Supply: AC 240V, 50Hz
Power Consumption: 140W
Dimensions (mm): 762 (W) x 580 (H) x 520 (D)
Weight (kg): 47
CRT: 68 cm

TV system & channel coverage

| System | VHF | UHF | CATV |
|---------|------|-------|--------------|
| PAL-B/G | 2-12 | 21-69 | X~Z+2,S1~S41 |

Colour System: PAL-B/G, NTSC (AV)
Sound output: 8W/8 Ω
Accessories: Remote control x 1

 Design and specifications are subject to change without notice.

PALSONIC CORPORATION PTY LTD
1 JOYNTON AVENUE
WATERLOO NSW 2017 AUSTRALIA
TEL: (02) 9313 7111
FAX: (02) 9313 7555
www.palsonic.com.au

**PALSONIC CUSTOMER SERVICE
TELEPHONE
AUSTRALIA: 1300 657 888**