

CLIFFORD®

Model 10.5X

➤ *Owner's Guide*

limited lifetime consumer warranty

Directed Electronics, Inc. ("Directed") promises to the original purchaser to repair or replace with a comparable reconditioned model any Directed unit (hereafter the "unit"), excluding without limitation the siren, the remote transmitters, the associated sensors and accessories, which proves to be defective in workmanship or material under reasonable use during the lifetime of the vehicle provided the following conditions are met: the unit was professionally installed and serviced by an authorized Directed dealer; the unit will be professionally reinstalled in the vehicle in which it was originally installed by an authorized Directed dealer; and the unit is returned to Directed, shipping prepaid with a legible copy of the bill of sale or other dated proof of purchase bearing the following information: consumer's name, telephone number and address; the authorized dealers name, telephone number and address; complete product description, including accessories; the year, make and model of the vehicle; vehicle license number and vehicle identification number. All components other than the unit, including without limitation the siren, the remote transmitters and the associated sensors and accessories, carry a one-year warranty from the date of purchase of the same. This warranty is non-transferable and is automatically void if: the original purchaser has not completed the warranty card and mailed it within ten (10) days of the date of purchase to the address listed on the card; the unit's date code or serial number is defaced, missing or altered; the unit has been modified or used in a manner contrary to its intended purpose; the unit has been damaged by accident, unreasonable use, neglect, improper service, installation or other causes not arising out of defects in materials or construction. The warranty does not cover damage to the unit caused by installation or removal of the unit. Directed, in its sole discretion, will determine what constitutes excessive damage and may refuse the return of any unit with excessive damage. TO THE MAXIMUM EXTENT ALLOWED BY LAW, ALL WARRANTIES, INCLUDING BUT NOT LIMITED TO EXPRESS WARRANTY, IMPLIED WARRANTY, WARRANTY OF MERCHANTABILITY, FITNESS FOR PARTICULAR PURPOSE AND WARRANTY OF NON-INFRINGEMENT OF INTELLECTUAL PROPERTY, ARE EXPRESSLY EXCLUDED; AND DIRECTED NEITHER ASSUMES NOR AUTHORIZES ANY PERSON OR ENTITY TO ASSUME FOR IT ANY DUTY, OBLIGATION OR LIABILITY IN CONNECTION WITH ITS PRODUCTS. DIRECTED DISCLAIMS AND HAS ABSOLUTELY NO LIABILITY FOR ANY AND ALL ACTS OF THIRD PARTIES INCLUDING ITS AUTHORIZED DEALERS OR INSTALLERS. DIRECTED SECURITY SYSTEMS, INCLUDING THIS UNIT, ARE DETERRENTS AGAINST POSSIBLE THEFT. DIRECTED IS NOT OFFERING A GUARANTEE OR INSURANCE AGAINST VANDALISM, DAMAGE OR THEFT OF THE AUTOMOBILE, ITS PARTS OR CONTENTS; AND HEREBY EXPRESSLY DISCLAIMS ANY LIABILITY WHATSOEVER, INCLUDING WITHOUT LIMITATION, LIABILITY FOR THEFT, DAMAGE AND/OR VANDALISM. THIS WARRANTY DOES NOT COVER LABOR COSTS FOR MAINTENANCE, REMOVAL OR REINSTALLATION OF THE UNIT OR ANY

CONSEQUENTIAL DAMAGES OF ANY KIND. IN THE EVENT OF A CLAIM OR A DISPUTE INVOLVING DIRECTED OR ITS SUBSIDIARY, THE PROPER VENUE SHALL BE SAN DIEGO COUNTY IN THE STATE OF CALIFORNIA. CALIFORNIA STATE LAWS AND APPLICABLE FEDERAL LAWS SHALL APPLY AND GOVERN THE DISPUTE. THE MAXIMUM RECOVERY UNDER ANY CLAIM AGAINST DIRECTED SHALL BE STRICTLY LIMITED TO THE AUTHORIZED DIRECTED DEALER'S PURCHASE PRICE OF THE UNIT. DIRECTED SHALL NOT BE RESPONSIBLE FOR ANY DAMAGES WHATSOEVER, INCLUDING BUT NOT LIMITED TO, ANY CONSEQUENTIAL DAMAGES, INCIDENTAL DAMAGES, DAMAGES FOR THE LOSS OF TIME, LOSS OF EARNINGS, COMMERCIAL LOSS, LOSS OF ECONOMIC OPPORTUNITY AND THE LIKE. NOTWITHSTANDING THE ABOVE, THE MANUFACTURER DOES OFFER A LIMITED WARRANTY TO REPLACE OR REPAIR THE CONTROL MODULE AS DESCRIBED ABOVE. Some states do not allow limitations on how long an implied warranty will last or the exclusion or limitation of incidental or consequential damages. This warranty gives you specific legal rights and you may also have other rights that vary from State to State.

This product may be covered by a Guaranteed Protection Plan ("GPP"). See your authorized Directed dealer for details of the plan or call Directed Customer Service at 1-800-876-0800. Directed security systems, including this unit, are deterrents against possible theft. Directed is not offering a guarantee or insurance against vandalism, damage or theft of the automobile, its parts or contents; and hereby expressly disclaims any liability whatsoever, including without limitation, liability for theft, damage and/or vandalism. Directed does not and has not authorized any person or entity to create for it any other obligation, promise, duty or obligation in connection with this security system.

Make sure you have all of the following information from your dealer:

A clear copy of the sales receipt, showing the following:

- Date of purchase
- Your full name and address
- Authorized dealer's company name and address
- Type of alarm installed
- Year, make, model and color of the automobile
- Automobile license number
- Vehicle identification number
- All security options installed on automobile
- Installation receipts

table of contents

limited lifetime consumer warranty	3
2-way LCD remote control	7
LCD screen	8
standard remote configuration	9
what is included	10
important information	10
system maintenance	11
fcc/id notice	12
2-way LCD remote control functions	13
standard configurations	13
standard LCD icon configurations	15
remote operation	19
system signal paging features	19
out of range notification	20
programming LCD remote	21
To enter programming mode	21
Beeps/Vibration On/Off	21
Illumination On/Off	22
Page notification	22
To exit programming mode	22
using your system	23
active arming	23
passive arming	24
multi-level security arming	25
disarming	26
disarming without a transmitter	28
dome light control	29
silent mode	29
panic mode	30
valet mode	31
one-time bypass	32
nuisance prevention [®] circuitry	33
auxiliary outputs (options)	34
shock sensor adjustment	35
To enter shock sensor adjustment mode:	35
Adjusting the Shock Sensor Setting	36
Exit Shock Sensor Adjustment Mode:	39
Reset Shock Sensor to Default Setting:	39

diagnostics	40
arming diagnostics	40
disarming diagnostics	41
table of zones	42
interpreting zone diagnostics	43
high frequency	44
owner recognition	44
rapid resume logic	45
power saver mode	45
programming	46
installation options	50
vehicle recovery system (vrs®)	50
arming the vrs®	51
vrs® triggered sequence	52
disarming the vrs®	53
programming options	54
security & convenience expansions	55
glossary of terms	58
quick reference guide	61

2-way LCD remote control

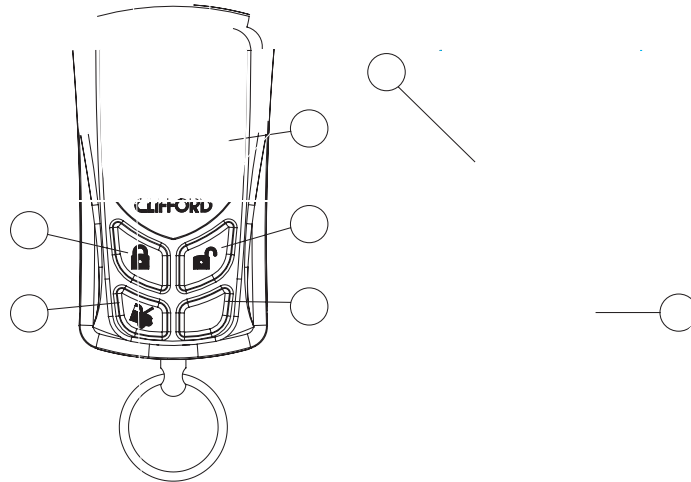

- | | |
|----|-------------------------------------|
| 1. | Auxiliary Channel Button |
| 2. | Arm Button |
| 3. | LCD Screen (see <i>LCD Screen</i>) |
| 4. | Disarm Button |
| 5. | Panic Button |
| 6. | Battery Compartment |
| 7. | Program Button |

LCD screen

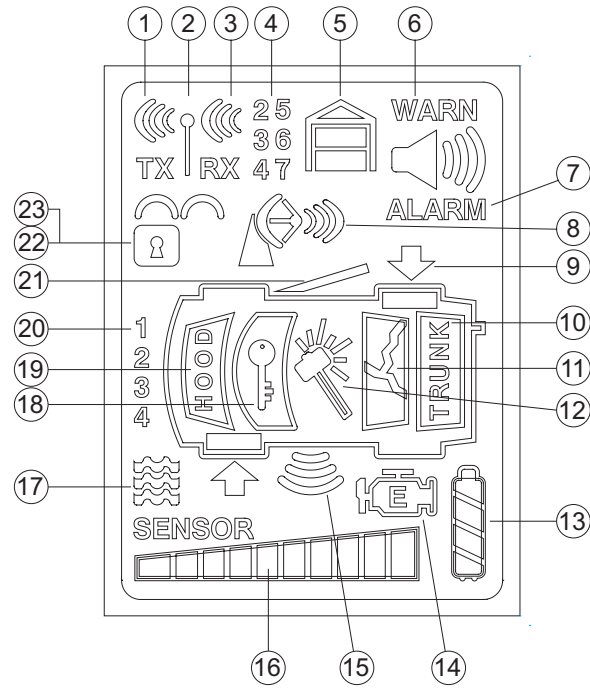

1. Transmit	13. Battery
2. Out of range	14. Remote start (option)
3. Receive	15. Field disturbance sensor
4. Auxiliaries	16. Shock sensor setting
5. Garage door (519H option)	17. Vibrator
6. Warn Away®	18. Ignition
7. Alarm	19. Hood
8. Ultrasonic sensor	20. Vehicle number
9. Tilt sensor	21. Door
10. Trunk	22. Arm
11. Glass breakage sensor	23. Disarm
12. Shock sensor	

standard remote configuration



controls the **Lock–Arm/Panic On/Panic Off** function.



controls the **Unlock–Disarm/Panic Off** function.



controls **Silent Mode™** and an **Auxiliary Output (2)**.



controls the **Panic On/Off** function (hold for 2-seconds).



and



pressed together control an **Auxiliary Output (3)**.



and



pressed together control an **Auxiliary Output (4)**.



and



pressed together control an **Auxiliary Output (5)**.



and



pressed together control an **Auxiliary Output (6)**.



(located on back of the remote) selects the vehicle to control and also provides user selection of LCD remote response .

what is included

- Control module
- 1 four-button 2-way LCD transmitter
- 1 four-button transmitter

note: On both remotes the panic button is the same color.

- Wire harnesses
- Dual diode harness
- The 514N six-tone programmable siren
- In-vehicle status LED indicator light
- A push-button Valet switch
- Your warranty registration
- Failsafe® Starter Kill ready circuitry
(may require additional labor)
- 548T transceiver/antenna

important information

Congratulations on the purchase of your state-of-the-art vehicle security system. This system has been designed to provide years of trouble-free operation. Due to the complexity of this system, it must be installed by an authorized dealer only. Installation of

this product by anyone other than an authorized dealer voids the warranty. All dealers are provided with preprinted dealer certificates to verify that they are authorized.

This owner's guide should help you to get the most out of your system. Please take the time to read it prior to using the system.

→ **system maintenance**

This system needs no specific maintenance beyond remote control battery replacement. The remote is powered by a 1.5V AAA battery.

The Battery Level indicator has four level indicators that serve as a visual indication of battery charge. When the battery reaches a low charge level that requires replacement, the remote control will generate a single notification chirp, and the Battery Level indicator will flash continuously.



Battery Replacement

Gently pull the end of the battery door away from the top of the remote control then slide the door up to expose the battery and remove the expired battery. Place the new battery into the remote control observing the correct polarity. When power is returned the remote control will display all icons in the LCD and generate all beeper tones once. Press any button on the remote to terminate the beeper tone review.

your warranty

Your warranty registration must be returned and the bar code serial number must not be removed. If the warranty registration is not returned, you do not have a warranty. It is also necessary to keep your proof of purchase, which reflects that the product

2-way LCD remote control functions

The LCD remote control buttons are used to send commands to the system. The descriptions below reflect the standard configuration for this system. The buttons can be custom configured for the user's specific needs by the installer. Also, the user can configure the LCD remote for certain responses (see *Programming LCD Remote* section).

standard configurations

Button

The arming function is controlled by pressing this button for one second.

Button

The disarming function is controlled by pressing this button for one second.

Button

Silent Mode™ and an optional auxiliary function are controlled by pressing this button. (Silent Mode™ works by pressing this button for less than one second before arming or disarming. An optional auxiliary function, such as trunk release, can be controlled by pressing this button for 1.5 seconds.)

The auxiliary output controls _____.



Button

The panic feature is controlled by pressing this button for approximately two seconds.

and Buttons

An optional auxiliary convenience or expansion function that you have added to your system can be activated by pressing these buttons simultaneously.

The auxiliary output controls _____.

and Buttons

An optional auxiliary convenience or expansion function that you have added to your system can be activated by pressing these buttons simultaneously.

The auxiliary output controls _____.

and Buttons

An optional auxiliary convenience or expansion function that you have added to your system can be activated by pressing these buttons simultaneously.

The auxiliary output controls _____.

and  Buttons

An optional auxiliary convenience or expansion function that you have added to your system can be activated by pressing these buttons simultaneously.

The auxiliary output controls _____.

Program Button (on rear of LCD remote)

Use this button to select the vehicle to control from the remote. Also use this button to configure response characteristics from the LCD remote (see *Programming 2-Way Remote*).

➔ **standard LCD icon configurations**



The transmit icon will be displayed while the remote control is transmitting a command to the vehicle.



The signal icon will be displayed if a command is transmitted to the vehicle but the command page is not received.



The receive icon will be displayed while the remote control is receiving a page from the vehicle.



The auxiliary and sensor icons will display which auxiliary is operating, or which security feature is in Warn Away® or alarm state.



The garage door icon—for future use.



The above Warn Away® displays when a security feature has been tripped, but not to full alarm. These will display for 5-seconds.

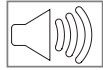

and ALARM Icons

The above icons will display for 5-seconds when a security feature has been tripped to a full alarm condition.



Icon

The ultrasonic sensor (detects motion within the vehicle) icon will display for full alarm by flashing 5-times and displaying continuously until the page is cleared.

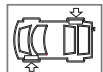

Icon

The tilt sensor icon will display for full alarm by flashing 5-times and displaying continuously until the page is cleared.



Icon

The trunk icon will flash until the beep and/or vibrate stops then it will display continuously until the page is cleared.



Icon

The glass breakage sensor icon will display for full alarm by flashing 5-times and displaying continuously until the page is cleared.



Icon

The shock sensor icon will display for both Warn Away® and full alarm by flashing 5-times and displaying continuously until the page is cleared.



Icon

The battery icon always displays the current charge capacity remaining in the remote's battery.



Icon

The remote start (option) icon displays when the vehicle is being remote started.



Icon

The field disturbance sensor icon will display for both Warn Away® and full alarm by flashing 5-times and displaying continuously until the page is cleared.



Icon

The shock sensor bar icon always displays the current sensitivity setting of the shock sensor.



Icon

The shock sensor "sensor" icon will display for both Warn Away® and full alarm by displaying continuously until the page is cleared.



Icon

The vibrator icon will always display if the remote is programmed for vibrator notification.



Icon

The ignition icon will display if the ignition is turned on when the vehicle's doors are locked (alarm condition).



Icon

The hood icon will flash until the beep and/or vibrate stops then it will display continuously until the page is cleared.



Icon

The vehicle icon always displays the current vehicle (maximum of 4 vehicles) being controlled by the remote. If a Warn Away® or alarm trigger should occur at one of the other vehicles, that vehicle's number will be displayed and the LCD will display that vehicle's status.



Icon

The door icon will flash until the beep and/or vibrate stops then it will display continuously until the page is cleared.



Icon

The arm icon will flash when the system is locking the doors and display continuously until the system is disarmed.



Icon

The disarm icon will flash when the system is unlocking the doors and display continuously until the system is armed.

transmitter functions

This system uses a computer-based learn routine to learn the transmitter buttons. This makes it possible to assign any transmitter button to any system function. The transmitter initially comes programmed with Standard Configuration, but may also be customized by an authorized dealer. The buttons described in this manual correspond to a Standard Configuration transmitter.

remote operation

The system operates at 434 MHz and incorporates Directed's proprietary out-board technology transceiver. The high frequency combined with Binary Data communication achieves superior range with two-way communication.

→ system signal paging features

A page is the signal the control module sends to the remote control as confirmation of receipt of a command or alarm system status.

When the remote control receives a page it will generate a page notification to the user (notifications are audible beeps and-or vibration) and the LCD Icons will display the current system status.

Command Page

When a command (arm/disarm, or auxiliary channel) from the remote control is sent and received, the system will send a command page back to confirm receipt.

Alarm Page

If the alarm system is triggered while armed, an Alarm Page will be sent to the remote control. When the remote receives an Alarm Page, the LCD icons will display the alarm system status information and the remote control will generate beeps and-or vibration.

An Alarm Page alert is a series of 5 groups of 4 rapid beeps (shock, trunk, door, ignition, or hood trigger) and the LCD icon that caused the alarm will display. This will repeat every 60 seconds to alert the user that the alarm system was triggered and will continue until the alarm page is cleared.

Page Recognition (Acknowledgement)

To clear a page alert/notification, quickly press any button on the remote control. This can be performed at any time during or after the page notification has occurred.

The remote control will not send a command to the system at this time; it will only clear future repeats of the page notification. The next time a button is pressed on the remote control it will send a command to the system.

→ out of range notification

If a command is issued from the remote, but the remote is set to the incorrect vehicle or is beyond the range of the vehicle to receive the command, the remote responds with 3 set of 2 quick beeps and the  icon will flash 3-times.

programming LCD remote

→ To enter programming mode

Press and hold the  button until one long beep is heard. Programming mode to customize the remote's response is now entered.

note: If no buttons are pressed within 5-seconds, programming mode will exit with 2-beeps.

→ Beeps/Vibration On/Off

Press  to select beeps/vibration On/Off. Beeps alone, or vibration alone, or beeps and vibration, or no beeps or vibration can be selected. Refer to the table below for these settings.

Beep/Vibrate settings	Programming response	Icon display*
Beeps only (default)	1-beep	Siren icon On
Vibrate only	1-vibrate	Vibrate icon On
Beep & Vibrate	1-beep and 1-vibrate	Vibrate and siren icon On
No Beep and No Vibrate	1 long beep	Vibrate and siren icons Off

***Note:** This is icon display during programming.

→ **Illumination On/Off**

Press  to select LCD backlight illumination On/Off. The LCD backlight will illuminate when a remote button is pressed, or a alarm status page is received.

LCD Backlight settings	Programming response
ON	1-beep, backlight ON
OFF	2-beeps, backlight OFF

→ **Page notification**

The remote control can be programmed to notify the user of a page (audibly beeping if the vehicle's status changes, e.g. door unlocked, engine started, vehicle violation, etc.). On the LCD remote press  to select page On/Off. One beep is page On, Two beeps is page Off. When programmed off the remote will not give any notification that a page was received from the vehicle.

Note: If programmed Off, **no alarms** will be notified to the remote. Command information (armed/disarmed) will be notified to the remote.

→ **To exit programming mode**

The LCD remote control will exit programming mode after 5-seconds of inactivity and will emit 1 long beep.

using your system

The buttons described in this manual correspond to the standard configuration. Remember, this is not the only way your transmitter may be set up. It can be custom configured to meet your needs. See your installer for additional details.

active arming

You can arm the system by pressing  of your remote for one second. When the system arms, from the vehicle you will hear a short siren sound, or chirp, and see the parking lights flash once. If the power door locks are controlled by the system, the doors will also lock. While the system is armed, the in-vehicle's status LED will flash approximately once per second, indicating that the system is actively protecting your vehicle. If you hear a second chirp after arming and note that the in-vehicle's status LED is flashing in groups, see the Diagnostics Section of this guide. This extra chirp is called Bypass Notification.

The LCD remote responds to active arming with one beep and the  icon will flash 5-times to indicate successful arming of the system.

If the LCD remote beeps twice after arming, the system has detected an active sensor that should be checked. For example, a door open icon will be displayed flashing 5-times on the LCD screen.

passive arming

The system can be programmed to arm itself automatically (called passive arming). If the system is programmed for passive arming, it will automatically arm 30 seconds after the ignition is turned off and the system detects that you have left the vehicle by opening and closing a door. Whenever the system is in its 30-second passive arming countdown, the in-vehicle status LED will flash twice as fast as it does when the system is armed. At the 20-second point of the countdown, the siren will chirp to indicate that the system is about to arm. At the 30-second point, the parking lights will flash to indicate that the system is armed.

The LCD remote responds to passive arming with one beep and the  icon will flash 3-times to indicate successful arming of the system.

note: If any protected entry point (such as a door or a switch-protected trunk or hood) is open, the system will not passively arm (unless forced passive arming is programmed on. See Programming Options section.) Additionally, if a door, hood or trunk is triggered during the arming countdown, the 30-second countdown starts over.



When armed your vehicle is protected as follows:



- Light impacts trigger the Warn Away® signal. When triggered, the siren chirps and the parking lights flash for a few seconds.
- Heavy impacts trip a Triggered Sequence. The sequence consists of the siren sounding continuously and the parking lights flashing for a pre-programmed period, which can range in duration from 1 to 180 seconds.
- If a door is opened, the system will immediately start





chirping the siren and flashing the parking lights. Three seconds later, the siren output changes to a continuous blast. This progressive response gives you time to disarm the system with your LCD remote if you inadvertently open the door while the system is armed, while still providing instant response (even if the door is immediately closed).

- Turning on the ignition key will trip the same progressive response as opening a door.
- The optional starter kill prevents the vehicle's starter from cranking.
- Any full trigger of the alarm system will immediately send an alarm page to your remote informing you that your vehicle should be checked.



multi-level security arming

Multi-Level Security Arming allows you to select which of the security system's inputs or sensors will be active and which will be bypassed at the time that the system is armed. (See the *Table of Zones* section of this guide.) Pressing  again within five seconds of arming the security system will activate the Multi-Level Security Arming feature. Each time  is pressed again, a different security level is selected. The different security levels can be selected as follows:

- Press  once: The siren chirps once. The system is armed.
- Press  a second time within five seconds: The parking lights flash twice. Zone 2 is now bypassed.
- Press  a third time within five seconds: The parking lights flash three times. Zone 4 is now bypassed.

- Press  a fourth time within five seconds: The parking lights flash four times. Zone 7 is now bypassed.
- Press  a fifth time within five seconds: The parking lights flash five times. Zones 2 and 4 are now bypassed.
- Press  a sixth time within five seconds: The parking lights flash six times. Zones 2 and 7 are now bypassed.
- Press  seven times within five seconds: The parking lights flash seven times. Zones 4 and 7 are now bypassed.
- Press  eight times within five seconds: The parking lights flash eight times. All zones except zone 5 are now bypassed.

note: Multi-Level Security Arming only applies to a single arming cycle. Once the system is disarmed and then re-armed, all the zones will be active again.

After each press of the  to reach the next level of security, the remote will emit normal arm notification (1 beep and 5 flashes of the  icon). For easiest operation in reaching each level of security, press  immediately **after** each notification.

➔ **disarming**

To disarm the system, press . You will hear two chirps, and the parking lights will flash twice. If the power locks are connected to the system, the doors will unlock. If the siren chirps either four or five times when disarming, refer to the *Diagnostics* section of this guide. This is called Tamper Alert.

The remote will indicate disarm notification with 2 beeps and 5 flashes of the  icon. If disarming after the system has been triggered, the remote control will send a diagnostic notification as a reminder. These diagnostic notifications are:

1. If a sensor triggered the system, the remote will emit 4 quick beeps and the LCD screen will indicate which sensor (5-flashes) tripped the alarm.
2. If a switch (Zone 1, 3, 5, or 6) triggered the system, the remote will emit 4 quick beeps and the LCD screen will indicate which switch (5-flashes) tripped the alarm.
3. If the system was triggered so many times that NPC is active the remote will emit the above notifications with 5 beeps instead of 4.



→ dome light control

security only

The dome light activates for 30-seconds after the system is disarmed.

Ignition controlled

The dome light activates for 30-seconds after the ignition is turned On.

door controlled

The dome light activates for 30-seconds after the system sees a door has closed. (If door was held open for longer than 3 minutes the dome light will not illuminate.)

full

The dome light activates for 30-seconds after seeing door closure, ignition, or security disarm. (This is the *factory* setting.)

→ silent mode





To temporarily turn off the arm or disarm chirps, use Silent Mode™. Simply press  for less than one second before arming or disarming, and the confirmation chirp(s) will be eliminated for that one operation only. If you want the arm/disarm chirps turned off permanently, your dealer can do this for you.

note: The Warn Away® response to lighter impacts is bypassed if the system is armed using Silent Mode. This ensures that no chirps will be emitted by the siren in an area you want chirp-free. The system is still fully capable of triggering. Only the Warn Away® response is bypassed.

The LCD remote responds with the normal arm/disarm notifications in silent mode. (If the remote has beeps programmed On, the remote will beep.)





panic mode

LCD remote

If you are threatened in or near your vehicle, you can attract attention by triggering the system with your LCD remote. Just press  or  button for approximately two seconds, and you will enter Panic Mode. The siren will sound and the parking lights will flash for the programmed siren duration. To stop Panic Mode at any time, press  or  button on the LCD remote again.

The LCD remote responds with one beep and display of the  icon upon entering Panic Mode.

4-button remote

If you are threatened in or near your vehicle, you can attract attention by triggering the system with your transmitter. Just press  or  for approximately two seconds, and you will enter Panic Mode. The siren will sound and the parking lights will flash for the programmed siren duration. To stop Panic Mode at any time, press , or  on the remote transmitter again.

→ valet mode

You can prevent your security system from automatically arming and triggering by using Valet Mode. This is very useful when washing the vehicle or having it serviced. In Valet Mode, the security system will not arm, even with the remote transmitter, but all convenience functions (door locks, trunk release, etc.) will continue to work normally.

To enter or exit Valet Mode:



1. Turn the ignition on.
2. Turn the ignition off.
3. Press and release the Valet button within 10 seconds.

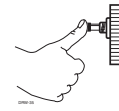



The status LED will light solidly if you are entering Valet Mode, and it will go out if you are exiting Valet Mode.

The remote will respond with 5-flashes of the  icon and 2 beeps on entering or exiting Valet® Mode.

To enter or exit Valet Mode using the transmitter:

1. Open any vehicle door.

Quickly press the following buttons in the sequence indicated.

2. Press .
3. Press .
4. Press  again.

The in-vehicle status LED will light solidly if you are entering Valet® Mode, and it will go out if you are exiting Valet® Mode.

→ **one-time bypass**

This feature stops the alarm from arming or activating any outputs that are programmed to activate when the alarm is armed.

One-time bypass will defeat the following actions:

Passive arming: If programmed ON the alarm will not arm itself.

If the remote is used to arm the alarm after exiting the vehicle:

Window roll up: If programmed ON this output will not activate.

Linked Auxiliary Outputs: If programmed to activate on arm, they will not activate.

To activate one-time bypass:

1. After parking turn the ignition off.
2. Turn the ignition On for more than 1-second and less than 3-seconds.
3. The siren will chirp once to indicate one-time bypass has been activated.

To cancel one-time bypass perform one of the following:

Arm then disarm the alarm.

Turn the ignition On for more than 3-seconds.

→ **nuisance prevention[®] circuitry**

Your system has Directed's Nuisance Prevention[®] Circuitry (NPC[®]). It prevents annoying repetitive trigger sequences due to

faulty door pin switches or environmental conditions such as thunder, jackhammers, airport noise, etc.

Example

If the alarm triggers three times within a 60-minute period and each time the same sensor or switch triggers the alarm, NPC® will interpret those triggers as false alarms. After the third trigger, NPC® ignores, or bypasses, that sensor or switch (along with any other sensors or switches sharing the same zone) for 60 minutes.

If the bypassed sensor tries to trigger the system while it is being bypassed, the 60-minute bypass period will start over. This ensures that a sensor that continually triggers will remain bypassed.

Doors are covered by NPC® differently; if the alarm is triggered by an open door for three full cycles, the doors will be bypassed until the trigger ceases.



note: Arming and disarming the system does not reset this function. The only ways to reset a bypassed zone are for it to not trigger for 60 minutes, or to turn on the ignition. If testing your system, it is important to remember that the NPC® programming can cause zones to be bypassed and appear to stop working. If five chirps are heard when disarming, NPC® has been engaged. If you wish to clear the NPC® memory, turn the ignition key on.



NPC® is On/Off programmable. See your dealer and the *Programming* section of this guide for more information.



auxiliary outputs (options)



This system also supplies outputs that can control convenience options such as remote control trunk release and window automation. Consult your dealer for available options for your system.

Channel 2 Trunk release: When connected, pressing  for 1.5 seconds will remotely release the vehicle trunk lid.

Channel 3 auxiliary output: When connected, pressing  and  will immediately activate this output to control an additional convenience option.

Channel 4 auxiliary output: When connected, pressing  and  will immediately activate this output to control an additional convenience option.

Channel 5 auxiliary output: When connected, pressing  and  will immediately activate this output to control an additional convenience option.



Channel 6 auxiliary output: When connected, pressing  and  will immediately activate this output to control an additional convenience option.

The remote will respond with a page notification consisting of one long beep and for 4-seconds displays the channel number on the LCD screen. This occurs at the remote after the system has received the command to activate any of the Auxiliary outputs.

shock sensor adjustment

→ To enter shock sensor adjustment mode:

note: The system must be disarmed, and doors and other protected entries (zones 1 and 6) must be closed, and ignition (zone 5) must be off.

1. Press and hold  and  buttons for 6-seconds.
2. The siren will emit one long chirp and LCD remote will emit 1 long beep when the buttons on the remote are released (or 1 vibrate, or 1 long beep with vibrate) to indicate entry into shock adjustment mode.
3. The word “SENSOR” on the LCD transmitter above the adjustment indicator bar  will flash for the duration of shock adjustment mode. The sensor bar indicator will display the current sensor sensitivity setting. Increased sensitivity is indicated as the bar fills to the right.



note: The LCD transmitter will also have the zone 2 icon and the alarm icon indicating.

4. The in vehicle LED will illuminate continuously for the duration of shock adjustment mode.

note: When the shock sensor adjustment mode is entered, all other timers and operations are bypassed until shock-sensor adjustment mode is exited.

→ Adjusting the Shock Sensor Setting

note: When adjusting the shock sensor, ensure that the vehicle's doors are closed.



1. Increase Sensitivity—Press and release the  button to increase shock sensor sensitivity by one step. The LCD transmitter beeps 2-times for each step increased in adjustment (and/or 1 vibrate if programmed). When the shock sensor adjustment reaches maximum sensitivity when the indicator bar is filled completely to the right . There are 21 levels of shock sensor adjustment, during sensor adjustment these levels are displayed on the indicator bar as listed below.

note: When the arm and disarm are programmed to a single button, then the AUX button is used to increase the sensitivity setting of the sensor.

Sensor Adjustment Level	Bar Number and Indication
0	no bars displayed
1	bar 1 flashes
2	bar 1 solid
3	bar 1 solid, bar 2 flashes
4	bar 1-2 solid
5	bar 1-2 solid, bar 3 flashes
6	bar 1-3 solid
7	bar 1-3 solid, bar 4 flashes
8	bar 1-4 solid
9	bar 1-4 solid, bar 5 flashes
10	bar 1-5 solid
11	bar 1-5 solid, bar 6 flashes
12	bar 1-6 solid
13	bar 1-6 solid, bar 7 flashes
14	bar 1-7 solid
15	bar 1-7 solid, bar 8 flashes
16	bar 1-8 solid
17	bar 1-8 solid, bar 9 flashes
18	bar 1-9 solid
19	bar 1-9 solid, bar 10 flashes
20	bar 1-10 solid

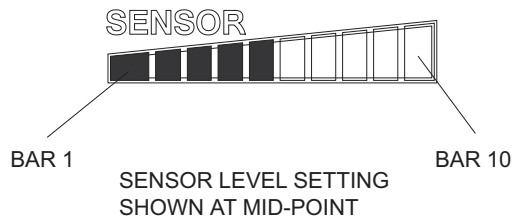
note: When the shock sensor adjustment mode is exited, the bar indicator will indicate continuously. For example if level 15 was being set (bars 1 through 7 indicating continuously, and bar 8 flashing), upon exiting adjustment mode bars 1 through 8 will indicate continuously.



2. Decrease Sensitivity—Press and release the  button to decrease shock sensor sensitivity by one step. The siren will beep 1-time for each step decreased in adjustment (1 vibrate if programmed). The shock sensor adjustment reaches minimum sensitivity (sensor Off) when the indicator bar is empty .
3. Testing Sensor—Use the heel of the palm of your hand to strike the door pillar of the car after any increase or decrease in adjustment. The siren will chirp once if the impact was great enough to generate a full trigger. Pre-warn level is set automatically. When desired setting is reached, sensor adjustment mode can be exited.

→ **Exit Shock Sensor Adjustment Mode:**



The adjustment mode will be exited if:

- No input from transmitter for 15-seconds.
- No input from sensitivity testing for 15-seconds.
- The ignition is turned On.
- The Valet button is pressed.

The siren and LCD remote will emit 1 long beep and the LED will extinguish when shock adjustment mode is exited.

→ **Reset Shock Sensor to Default Setting:**

The shock sensor can be restored to a default setting of 10 to facilitate re-adjustment at any time **while in** adjustment mode.

1. Simultaneously press the  and  buttons.
2. The LCD remote will emit 3 quick beeps to indicate the sensor has been reset to level 10 (mid-range).
3. The system returns to shock sensor adjustment mode for further adjustment, if required.

diagnostics

The microprocessor at the heart of your security system is constantly monitoring all of the switches and sensors that are connected to it. It detects any faulty switches and sensors and prevents them from disabling the entire system. The microprocessor will also record and report any triggers that occurred during your absence. Refer to the *System Status Chirps* and *Table of Zones* charts for diagnostic information.

→ **arming diagnostics**

If the system is armed while an input is active (door open, sensor triggering, etc.) the unit will chirp once when arming and then one more time a few seconds later. This is called Bypass Notification.

note: Bypass Notification will not occur when using Silent Mode™ or if chirps have been programmed OFF.

The security system will ignore the input that was active when the system was armed, until the input goes away. Three seconds later the system will monitor that input normally. For example, if your vehicle has interior light exit delay, and you arm the system before the interior light goes out, you may hear Bypass Notification chirps. Once the light shuts off, however, the doors are monitored normally.

→ **disarming diagnostics**

Extra disarm chirps are the Tamper Alert. If four chirps are heard when disarming, the system was triggered in your absence. If five chirps are heard, a zone was triggered so many times that Nuisance Prevention® Circuitry has bypassed that zone. The in-vehicle status LED will indicate which zone was involved. (See *Table of Zones* section of this guide.) The system will retain this information in its memory, and continue to chirp four or five times each time it is disarmed, until the next time the ignition key is turned on.

→ **system status chirps**

The siren will chirp when arming/disarming the system. The pattern of chirps will audibly report the system's status as described below.

Action	Number of Chirps	Description
Arm	1	System armed
Arm	1 (3-second delay), 1	System armed with Bypass Notification
Disarm	2	System disarmed
Disarm	4	System disarmed with Tamper Alert
Disarm	5	System disarmed NPC® active

→ table of zones

The zone number is the number of LED flashes used by the system to identify that input. The standard input assignments are listed below, along with spaces to write in any optional sensors or switches you have had installed.

Zone - Number of LED Flashes	Description	Dealer-Installed Options
1	Instant trigger - often used for trunk pinswitches	
2	Shock sensor input - a light impact activates warn away and a heavier impact activates full alarm.	
3	Door switch trigger	
4	Optional sensor inputs for warn away and full alarm notification.	
5	Ignition trigger	
6	Hood trigger	
7	Optional sensor inputs for warn away and full alarm notification.	

→ interpreting zone diagnostics

Warn Away responses are not reported by arming or disarming diagnostics. If you receive a Bypass notification when arming or a Tamper Alert notification when disarming, look at the in-vehicle status LED. Active or triggered zones will be indicated by a pattern of blinks by this LED.

Example

If Zone 3 was active or triggered, the in-vehicle LED will blink three times with a two-second pause. Then it will blink three times again, and repeat until the ignition is turned on.

note: Your system stores the last six triggered zones in memory. If your system has been triggered but the LED has been reset by turning on the ignition, your dealer can still recall the last six zones that were triggered. Contact your dealer for details.

code hopping

The receiver and transmitters each use mathematical formulas called algorithms to change their codes each time the transmitter is used. This technology has been developed to increase the security of the unit. The control unit knows what the next codes should be. This helps to keep the transmitter "in sync" with the control unit even if you use the remote control out of range of the vehicle. However, if the transmitter has been pressed many times out of range of the vehicle, or if the battery has been removed, it may get out of sync with the control unit and fail to operate the system. To re-sync the remote control simply press



of the transmitter several times within range of the vehicle. The alarm will automatically re-sync and respond to the transmitters normally.

high frequency

Your system transmits and receives at 434 MHz. This provides a cleaner spectrum with less interference and a more stable signal. Enjoy a phenomenal increase in range – even in areas with high radio interference.

owner recognition

Owner Recognition is a feature available exclusively from Directed. Using the Directed Bitwriter®, a hand-held programming tool, your dealer can program many of the system settings. The programmer makes it possible to program different settings for each transmitter that is used with the system. Then, whenever a specific transmitter is used, the system will recall the settings assigned to that transmitter. Owner Recognition lets up to four users of the system have different settings that meet their specific needs. It is almost like having four separate alarms in your vehicle, one for each user.

note: Owner Recognition cannot be programmed without a Directed Bitwriter® and the necessary software. Check with your dealer for more information.

rapid resume logic

This Directed system will store its current state to non-volatile memory. If power is lost and then reconnected, the system will recall the stored state from memory. This means if the unit is in Valet Mode and the battery is disconnected for any reason, such as servicing the car, when the battery is reconnected the unit will still be in Valet Mode. This applies to all states of the system including arm, disarm, VRS®, and Valet Mode.

power saver mode

Your system will automatically enter Power Saver Mode while armed or in Valet® Mode, after a period of time in which no operation has been performed. This lowers the current draw to the vehicle's battery. Power Saver Mode takes over under the following conditions:

- Power Saver when the system is armed: After the system has been armed for 24 hours, the in-vehicle LED will flash at half its normal rate, decreasing the system's current draw.
- Power Saver in Valet® Mode: When the system enters Valet® Mode the in-vehicle LED illuminates steadily. If the vehicle

is not used (ignition is not turned on) for a period of one hour while the system is in Valet® Mode, the LED will shut off. If the system remains in Valet® Mode, the LED will come back on the next time the ignition is turned on and then back off.

programming

Programming options control what your system does during normal operation, and require few or no additional parts. However, some may require additional installation labor.

The following is a list of the program settings, with the factory settings in **Bold**:

- **Active arming** (only with the remote) or passive arming (automatic arming 30-seconds after the last door has been closed).
- Arming/disarming confirmation siren chirps **on** or off.
- The ignition controlled door lock feature **on** or off: With this feature on, the doors will lock three seconds after the ignition is turned on, and the doors are closed, and unlock when the ignition is turned off. The system will not lock the doors when the ignition is turned on with any door open. If your installer is programming the security system with the Directed Bitwriter, ignition lock and unlock are independent features and can be programmed separately.
- Passive door locking (with passive arming) or **active door locking** (only when arming with the remote). Passive locking

allows the vehicle's doors to lock when the security system passively arms (after the 30 second countdown). This feature only works if passive arming has been programmed.

note: When programmed for passive arming and active lock, if the system is disarmed without a door being opened, the system will relock the doors when it passively rearms.

- Panic mode **enabled**/disabled with the ignition on: Some states have laws against siren capability in a moving vehicle.
- Forced passive arming **on** or off: If your system is programmed for passive arming and the forced passive arming feature has been programmed on, the system will passively arm after one hour, even if a protected entry has been left open. This feature is useful if a door has been left ajar when leaving the vehicle. Forced passive arming ensures that the security system will be armed in every situation.

note: When the system passively arms after one hour, the entry point that has been left open, and anything connected to the same zone, is bypassed and cannot trigger the system. However, the remaining inputs to the system are fully operational.

- Automatic Engine Disable (AED) on or **off**: The purpose of this feature is to protect the vehicle from being stolen at all times, regardless of whether or not the alarm is armed. If AED is programmed on, the starter of the vehicle will be disabled 30 seconds after the ignition is turned off. Once the key is turned off, the in-vehicle LED will flash slowly (one-

half its normal armed rate) to indicate the AED arming cycle. Thirty seconds later, the starter of the vehicle will be disabled. To start the car, it will be necessary to disarm the system with the remote. It is also possible to disarm the AED feature by turning the ignition key to the RUN position and pressing the Valet® button the programmed number of times. AED is disabled when the system is in Valet® Mode.

note: This feature will only function if the Failsafe® Starter Kill relay has been installed.

- ▶ Full trigger response **30** or 60 seconds: This determines how long the full triggered sequence lasts. Some states have laws regulating how long a security system can sound before it is considered a nuisance. If your installer is programming the security system with the Directed Bitwriter, the full triggered response can be programmed for any duration ranging from 1 to 180 seconds.
- ▶ Nuisance Prevention® Circuitry **on** or off: Please refer to the NPC® section of this manual for a complete explanation of how NPC® operates. If NPC® is programmed off, the security system will respond to inputs from any sensor indefinitely.

note: Because many states have laws regulating security systems, programming NPC® off may cause your system to violate state laws.

- Progressive door trigger **on** or off: When the system is armed and a door is opened, the system responds with ten chirps prior to beginning the full triggered sequence. If an instant trigger is desired, the progressive door trigger can be programmed off.
- Valet® pulse count: The number of presses of the Valet® button required to disarm the security system, AED, or the VRS® system can be programmed from one to five presses. The default setting is **one** press.
- Siren tones and chirp volume: The output of the Revenger® Soft Chirp® siren consists of six different tones in sequence. Any of these tones can be eliminated by your dealer, resulting in a unique, easily identifiable siren sound. The siren chirps can be either full volume or **six decibels quieter** than the full alarm blast.

installation options

The system has many options that may require extra parts and labor. Some of the possibilities are listed here.

- Progressive unlocking: In most cars with electric power door locks, the system can be configured so that when the system is disarmed, only the driver's door unlocks. A second press of the  button unlocks the other doors.
- Vehicle Recovery System (VRS®): VRS® is an anti-carjacking device designed to help in the safe recovery of your vehicle in case of a carjacking. Please refer to the Vehicle Recovery System section of this guide for a complete explanation of how the Vehicle Recovery System operates.

vehicle recovery system (vrs®)

The optional VRS® feature is designed to ensure that any unauthorized user of your vehicle (even if using your keys and remote control) will not be able to permanently separate you from your vehicle.

The VRS® cannot prevent a carjacking attempt; however, it does ensure that if your vehicle is taken by an unauthorized user, it will be disabled (after several progressive warnings) as safely as possible. Should a carjacking occur, the VRS® allows you to concern yourself with your personal safety without worrying about your property.

Directed has engineered this vehicle security system, the Failsafe® Starter Kill, and the VRS® feature to provide the best combination of personal safety and property protection available. When properly installed, the system can never inadvertently stop your vehicle in traffic or on railroad tracks while the vehicle is in operation. It is unlike other systems that shut down your engine while it is running. This system is designed to perform starter interrupt, or starter kill. The Failsafe® Starter Kill cannot shut down an already-running engine – it can only prevent an engine from starting in the first place.

important! Any installation that allows this product to shut down a vehicle's engine when it is running is contrary to the product's design and intended usage, and Directed hereby expressly disclaims any liability resulting therefrom.

→ **arming the vrs®**

To arm the VRS®, turn the ignition to the ON position and press the arm button on the remote transmitter for one second. The parking lights will flash and the siren will chirp once. This can be done before driving or while driving the vehicle. Once the system is armed, it will initiate its triggered sequence (see below) if any door is opened and closed. If you are forced from the vehicle, the system will trigger as the door is opened and closed. This is how the system works to combat intersection carjacking. To protect against parking lot carjacking, arm the VRS® before leaving the vehicle. The system will now trigger automatically the next time you or anyone drives the vehicle. This helps to protect the vehicle

if someone takes your keys and remote transmitter by force in a parking lot.

note: If the VRS® system is armed while operating the vehicle and not disarmed prior to leaving the vehicle, it is still armed and will trigger the next time the vehicle is driven.

→ vrs® triggered sequence

Fifteen seconds after the last door has closed, the in-vehicle LED will begin flashing. This delay is intended to allow you time to distance yourself from your vehicle in the event of a carjacking.

Forty-five seconds later, the siren begins chirping and the parking lights begin flashing. This time could be used to notify authorities that your vehicle has been hijacked, and tell them what the VRS® will do next.

Fifteen seconds after the siren chirps begin, the siren's output will change to a continuous blast.

From this point on, when the ignition key is turned off, the VRS® will immediately turn on the starter kill. This will prevent the vehicle from being restarted, thus immobilizing it at that spot.

Three minutes after the constant siren output begins, the flashing parking lights and the siren will stop. The starter kill will remain active until the system is disarmed. If the door is opened or the ignition is turned off and on in an attempt to restart the car, the siren and light flashing will begin again.

disarming the vrs®

Take the time to familiarize yourself with the VRS® triggering sequence and the disarm procedure. It is important to recognize and identify the VRS® trigger sequence and know how to disarm it in case of accidental activation.

Once the VRS® is armed, it does not disarm automatically. You must disarm it the next time you operate the vehicle. You must disarm it with one of the following procedures:

If the system has not entered the triggered sequence (siren has not started chirping):

1. Turn the ignition on.
2. Press  on the transmitter for one second. The lights will flash and the siren will chirp twice.

If the system has entered the triggered sequence (siren has begun chirping), pressing the disarm button of the transmitter will not disarm VRS®. To disarm the VRS® during a VRS® trigger sequence:



1. Turn the ignition on.
2. Press the Valet button the pre-programmed number of times to disarm the VRS® system.

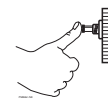

note: If the VRS® system has begun its chirping sequence, the ignition must be turned off, then on to disarm. If you are driving the vehicle at the time, pull to a safe place away from traffic and follow the triggered sequence disarm procedure.

programming options

See your dealer for further details on the options listed below available with this system.

Automatic Engine Disable: Prevents the vehicle from being started even if the vehicle is not armed after turning the ignition Off and exiting the vehicle.

Comfort Closure: Windows will close upon locking the vehicle.

Dual Sensor Trigger: If programmed On both the onboard and at least one of the optional sensors need to be triggered within 1-second of each other for full alarm.

note: In dual sensor mode, the LCD remote will report showing both zones that tripped the alarm. The in-vehicle LED will flash to indicate only the last sensor of the pair which tripped the alarm.

Forced Passive Arming: If passive arming is on and a door is left open the system will be armed after 30-seconds.

High Security Disarm: If the system is triggered this feature allows the user to silence the siren and reset the system to the armed state without having to visually check the system status.

Multi-level Arming: Allows bypassing of user selected alarm zones of the vehicle.

Grouped Arming: Allows bypassing of the group of alarm zones for warn-away, or both warn-away and full alarm of the vehicle.

Panic with Ignition Off: Prevents the Orange Panic button on the remotes from activating panic with ignition On (not allowed in some states).

Parking Light Supervision: The parking lights will illuminate for 30-seconds after disarming the system or turning the ignition off.

Remote Start Reporting: This channel 3 program option allows bypass of the security inputs that would trigger an alarm when activating an added optional remote start system, but still retains a high level of security.

Retained Accessory Power: This output from the security system can be connected to vehicle accessories. After the ignition has been turned off, it will continue to supply power until a door has been open and closed.

security & convenience expansions

Here we have listed only some of the many expansion options available. Please contact your dealer for a complete explanation of all the options available to you.

Audio Sensor: Metal on glass, glass cracking, and breaking glass each produce distinctive acoustic signatures. The 506T audio sensor uses a microphone to pick up sounds, and then analyzes them with proprietary acoustic software to determine if the glass has been struck.

Backup Battery: The 520T keeps the system armed, triggers the alarm and keeps the starter kill active if main battery power is disconnected.

Field Disturbance Sensor: An invisible dome of coverage is established by installing the 508D "radar" sensor. Your security system can then react to any intrusions into this field with the triggered sequence.

Headlight and Parking Light Automation: The 545T Nite-Lite® will automatically turn on your parking and headlights when it gets dark. In addition, the 545T will turn your headlights on whenever the windshield wipers are used. A transmitter function can also be used to turn on your parking and headlights for a programmed time.

Power Trunk Release: The channel two output of the system can operate a factory power release for the vehicle's trunk or hatch. (An additional relay may be required.) If the factory release is not power activated, then Directed's 522T trunk release solenoid can often be added.

Power Window Control: Automatic power window control is provided with the 529T and 530T systems.

Valet Start System: For the ultimate in convenience, the Valet start system can start your vehicle, monitor engine functions, and power your climate control system with a push of a button. Over-rev protection, open-hood lockout, brake pedal shutoff, and automatic timer shutoff are all included. (This feature is only for automatic transmission, fuel-injected vehicles.)

glossary of terms

ASK Amplitude Shift Keying—a method of transmitting data.

Control Unit: The "brain" of your system. Usually hidden under the dash area of the vehicle. It houses the microprocessor which monitors your vehicle and controls all of the system's functions.

Fail Safe Starter Kill: An automatic switch controlled by the security system which prevents the vehicle's starter from cranking whenever the system is armed. The vehicle is never prevented from cranking when the system is disarmed, in Valet mode, or should the starter interrupt switch itself fail. Your system is ready for this feature, however installation may require additional labor.

Input: A physical connection to the system. An input can be provided by a sensor, pinswitch or through an existing system in the vehicle, such as ignition or courtesy lights.

In-vehicle status LED: A light mounted somewhere in the vehicle. It is used to indicate the status of your system. It is also used to report triggers and faults in the system or sensors.

LCD: This is a Liquid Crystal Display used on your remote transmitter to display your vehicles status/alarm information.

Shock Sensor: This is a sensor mounted in the vehicle that is designed to pick up impacts to the vehicle or glass.

Siren: Noise generating device usually installed in the engine compartment of the vehicle. It is responsible for generating the

"chirps" you hear, as well as the six tones you hear while the alarm is triggered.

Transmitter: Hand-held, remote control which operates the various functions of your system.

Trigger or Triggered Sequence: This is what happens when the alarm "goes off" or "trips". The triggered response of your system consists of the siren sounding and parking light flashing for the programmed duration.

Valet Button: A small push-button switch mounted somewhere inside the vehicle. It is used to override the alarm when a transmitter is lost or damaged, or to enter or exit Valet mode.

Warn Away® Response: Lighter impacts to the vehicle will generate the Warning Zone response. It consists of several seconds of siren chirps and parking light flashes.

Zone: A zone is a separate input that the alarm can recognize as unique. Each input to the system is connected to a particular zone. Two or more inputs often share the same zone.

Cut along dotted line and fold for a quick and easy reference to keep in your purse or wallet.

QUICK REFERENCE GUIDE

To arm using your LCD remote

- You can activate, or arm, the system by pressing  on your remote for one second. When the system arms, you will hear a short siren sound, or chirp, and the parking lights will flash once. If the vehicle's power door locks have been connected to the system, the doors will lock.

To disarm using your LCD remote

- To disarm the system, press . You will hear two chirps, and the parking lights will flash twice. If power locks are connected to the system, the doors will unlock. If the siren chirps either four or five times when disarming, see Diagnostics section. This is called Tamper Alert.

Arming while driving

- Press  on your remote for two second while the vehicle is running. The system will chirp once and then once more to indicate that the ignition is on.

Disarming without a LCD remote

- Turn on the ignition. Press and release the Valet® button the programmed number of times within 15 seconds. After five seconds, the system will disarm. If it does not, you may have waited too long. Turn the ignition off and on and try again.

To enter or exit Valet® Mode

- Turn ignition to RUN position, then turn to OFF position. Press and release the Valet® button within 10 seconds. The in-vehicle status LED will light solid if you are entering Valet® Mode, and it will go out if you are exiting Valet® Mode.

To activate Panic Mode

- Press and hold  down for approximately two seconds.

To exit Panic Mode

- Press  on the remote.

To activate Silent Mode™

- Press  briefly before arming or disarming, and the confirmation chirp(s) will be eliminated for that one operation only.

Location of Valet® Button _____

Number of Valet® Button pulses for disarming _____

The company behind this system is Directed Electronics, Inc.

Since its inception, Directed has had one purpose, to provide consumers with the finest vehicle security and car stereo products and accessories available. The recipient of more than 20 patents in the field of advanced electronic technology, Directed is ISO 9001 registered.

Quality Directed Electronics products are sold and serviced throughout North America and around the world.

Call **(800) 274-0200** for more information about our products and services.



Directed® is committed to delivering world class quality products and services that excite and delight our customers.

Directed
ELECTRONICS, INC.

Directed Electronics, Inc.
Vista, CA 92081
www.directed.com

© 2005 Directed Electronics, Inc. - All rights reserved
G3301 02-05