

RCA

DVD Player User's Manual

Please read this manual
before using this product for
the first time.

Changing Entertainment. Again.



TOCOM 15909480

Model: DRC600N

Important Information

CAUTION

**RISK OF ELECTRIC SHOCK
DO NOT OPEN**



This symbol indicates that this product incorporates that this product incorporates double insulation between hazardous mains voltage and user accessible parts.



This symbol indicates "dangerous voltage" inside the product that presents a risk of electric shock or personal injury.



This symbol indicates important instructions accompanying the product.

WARNING

To reduce the risk of fire or shock hazard, do not expose this DVD player to rain or moisture.

CAUTION

THIS PRODUCT UTILIZES A LASER. USE OF CONTROLS OR ADJUSTMENTS OR PERFORMANCE OF PROCEDURES OTHER THAN THOSE SPECIFIED HEREIN MAY RESULT IN HAZARDOUS RADIATION EXPOSURE. DO NOT OPEN COVERS AND DO NOT REPAIR YOURSELF. REFER SERVICING TO QUALIFIED PERSONNEL.

FCC INFORMATION

This product has been tested and found to comply with the limits for a Class B digital device, pursuant to Part 15 of the FCC Rules. These limits are designed to provide reasonable protection against harmful interference when the product is operated in a residential installation. This product generates, uses and can radiate radio frequency energy and, if not installed and used in accordance with the instruction manual, may cause harmful interference to radio communications. However, there is no guarantee that interference will not occur in a particular installation. If this product does cause harmful interference to radio or television reception, which can be determined by turning the product off and on, the user is encouraged to try to correct the interference by one or more of the following measures:

- Reorient or relocate the receiving antenna.
- Increase the separation between the product and receiver.
- Connect the product into an outlet on a circuit different from that to which the receiver is connected.
- Consult the dealer or an experienced radio/TV technician for help.
- This class B digital apparatus meets all requirements of the Canadian Interference Causing Equipment Regulations.

CAUTION

FCC Regulations state that unauthorized changes or modifications to this equipment may void the user's authority to operate it.

Note:

This DVD player is designed and manufactured to respond to the Region Management Information. If the Region number of a DVD disc does not correspond to the Region number of this DVD player, this DVD player cannot play the disc. The Region number for this DVD player is Region No 1.

Note:

This device is protected by U.S. patent numbers 4,631,603 and 4,577,216 and 4,819,098 and other intellectual property rights. The use of Macrovision's copy protection technology in the device must be authorized by Macrovision and is intended for home and other limited pay-per-view uses only, unless otherwise authorized in writing by Macrovision. Reverse engineering or disassembly is prohibited.

Product Registration

Please fill out the product registration card return it immediately. Returning this card allows us to contact you if needed.

Product Information

Keep your sales receipt to obtain warranty parts and service and for proof of purchase. Attach it here and record the serial and model numbers in case you need them. The numbers are located on the back of the player.

Model No. _____

Serial No. _____

Purchase Date: _____

Dealer/Address/Phone: _____

**CLASS 1
LASER
PRODUCT**

Precautions



Things to consider...

Protect components from overheating

- Don't block ventilation holes on any of the components. Arrange the components so that air can circulate freely.
- Don't stack components.
- When you place components in a stand, make sure you allow adequate ventilation.
- If you connect an audio receiver or amplifier, place it on the top shelf.

Position cables properly to avoid audio interference

- Insert each cable firmly into the designated jack.
- If you place components above the TV, route all cables down the side of the back of the TV instead of straight down the middle of the back of the TV.
- If your antenna uses 300-ohm twin lead cables, do not coil the cables. Also, keep the twin lead cables away from audio/video cables.

Installation in a car

When installing the player in a car, make sure it is firmly secured to stop it being flung about if the car brakes or pulls away sharply. A badly fitted player can endanger the life of the driver and passengers.

Types of discs you can play

This DVD Player is capable of playing the following types of discs.



Digital video discs - 12 cm and 8 cm, single or double sided, single or dual layer. DVDs are high density optical discs on which high quality picture and audio are recorded by means of digital signals.



Regional Coding

Your DVD player responds to the region management information recorded on a DVD disc. If the Region Code on the disc and the Region Code on the player don't match, the disc won't play. The region code for your player is **region 1**.

So, if you are going to buy a DVD disc, pay attention to the logo: it has to be the right one. **ALL** means all regions.

Region Codes - 1: USA, Canada - 2: Europe, the Middle East, Rep. of South Africa, Japan - 3: Southeast Asia, Taiwan - 4: Central America, South America, Australia, Mexico, New Zealand - 5: Russian federation, Africa (except Egypt and Rep. of South Africa), India, Pakistan - 6: China.



DVD-R, DVD-RW - Most **DVD-R** (one recording only), **DVD-RW** and **DVD+RW** discs (rewritable). Compatibility is dependent on the burner and discs you use.



Video CD (VCD) - Video Compact Disc.

CD on which you can record up to 74 min. of VHS-quality video associated with still images, audio tracks and interactive menus.



CD-R, CD-RW - Most **CD-R** (one recording only) and **CD-RW** discs (rewritable). Compatibility is dependent on the burner and discs you use. Please see page 23 to discover our CD-R burning tips.



Audio CDs - Audio CDs and most recordable audio CDs (8 and 12 cm).



MP3 files - CD-Rs containing **SOUND** files in MP3 format.



JPEG files - CD-Rs containing **IMAGES** in JPEG format.

Notes:

Some discs may not be compatible due to laser pickup and disc design.

This product incorporates copyright protection technology that is protected by method claims of certain U.S. patents and other intellectual property rights owned by Macrovision Corporation and other rights owners. Use of this copyright protection technology must be authorized by Macrovision Corporation, and is intended for home use only unless otherwise authorized by Macrovision Corporation. Reverse engineering or disassembly is prohibited.

Graphics contained within this publication are for representation only. Your unit might differ.

Care and Maintenance

Maintenance of Cabinet

For safety reasons, when cleaning the cabinet be sure to disconnect the AC power cord from the AC outlet.

- Do not use benzene, thinner, or other solvents for cleaning.
- Wipe the cabinet with a soft cloth.

Formation of Condensation

- Due to sharp changes in temperature and humidity, condensation may form if warm air comes in contact with any cold parts inside the player.
- When condensation forms inside the player, the player may not operate correctly. If this occurs, leave the player at room temperature until the inside of the player becomes dry and operational.
- If condensation forms on a disc, wipe the disc with a soft, dry cloth by moving the cloth from the center hole toward the outer edge.

Handling Discs

- Don't touch the disc's signal surfaces. Hold by the edges or by one edge and the hole in the center.
- Don't affix labels or adhesive tape to label surfaces. Don't scratch or damage the label.
- Do not use damaged (cracked or warped) discs.

Cleaning Discs

- Dirty discs can cause reduced video and audio performance. Always keep discs clean by wiping them gently with a soft cloth from the inner edge toward the outer perimeter.
- If a disc becomes dirty, wet a soft cloth in water, wring it out well. Wipe the dirt away gently, and remove any water drops with a dry cloth.
- Do not use record-cleaning sprays or anti-static agents on discs. Also, never clean the discs with benzene, thinner, or other volatile solvents which may cause damage to the disc surface.

Handling Cautions

- Before connecting other components to this player, be sure to turn all components off.
- Don't move the player while a disc is being played. The disc may get scratched or broken, and the player's internal parts may be damaged.
- Don't put any container filled with liquid or any small metal objects on the player.
- Don't place anything other than the disc in the disc tray.
- Exterior influences such as lightning and static electricity can affect normal operation of this player. If this occurs, turn the player off and on again with the ON • POWER • OFF button, or disconnect and then reconnect the AC power cord to the AC power outlet. The player will operate normally.
- Be sure to remove the disc and turn off the player after use.

Graphics contained within this publication are for representation only. Your unit might differ.

Contents

Graphics contained within this publication are for representation only. Your unit might differ.

Player connections and initial settings

Precautions	1
Care and maintenance	2
Initial setup	4-5
• Your DVD Player and its accessories	
• Fitting the battery beneath your player	
• Initial setup of your remote control	
The player's power supply	6
• Using the power adapter	
• Using the battery	
• Charging the battery	
Other connections	7
• Connecting the player to a television	
• Using headphones	
• Connecting Audio-Video output to the player	
Using your DVD player	8
• Preparation	
• Function keys	
• Jacks and controls	
Remote control	9
Menus and interactive banners	10-11
• Selecting menu functions and options	
• Titles, chapters • Audio language, Subtitle languages • Angles • Repeat	
• Playback • Intros can	
Display and Sound menus	12-13
• Format • TV standard	
• Setup menu language	
• Virtual Surround • Sound Logic	

Playing your discs DVDs, audio CDs

Basic functions	14-15
• Loading a disc	
• Playing a disc	
• Quick search for pictures or tracks	
• Still picture and frame advance • Slow motion • Direct access to a music track	
• Titles, chapters, time elapsed, audio and subtitles	

Operation Advanced functions

Play modes	16
• Standard playback	
• Random play	
• Programming playback	
Repeat playback	17
• Repeat play	
• Repeat playback between two points A and B	
Other functions	18
• DVD and Video CD - Zoom	
• DVD - Camera angles	
• Video CD - Playback control menu (PBC)	
Reading JPEG and MP3 files	19
• Reading JPEG files	
• What's MP3?	
• MP3 CD Playback	
• Song skip	
Parental Control	20
• Setting a password	
• DVD - Ratings limits	
Preferred languages	21-22
• Language of player menus	
• AUDIO - Language of the dialogues	
• DVD - Language of the subtitles	
CD-Rs and MP3 files	23
• About CD-R discs	
• About MP3 files copied onto CD-Rs	
Appendix	24
• Troubleshooting guide	
• Warranty	
• Accessories	

Initial setup ...

Your DRC600 and its accessories



Thank you for purchasing our DVD Player. Unpack the box completely and tear off any protection films.

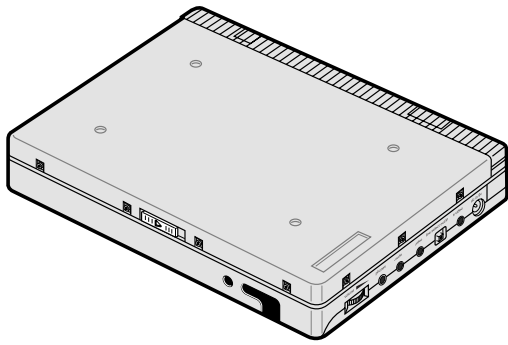

Your portable DVD player

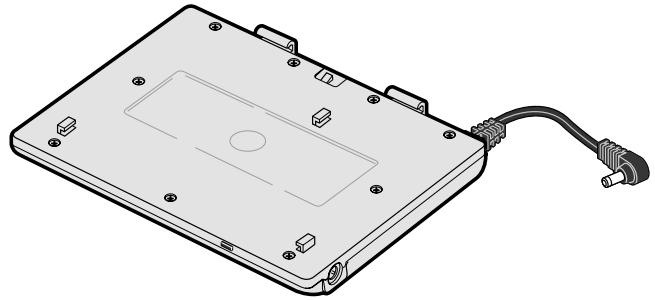

*Battery RB-LiP01
(part number 258341)*

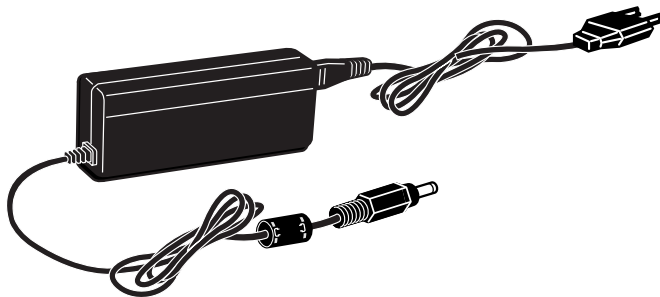

*Power adapter and charger
(part number 258342)*

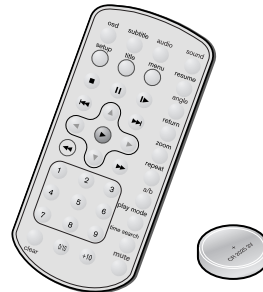

*Remote control with battery CR 2025
(part number 258343)*



*Audio/Video Cable
(part number
258344)*



*S-Video cable
(part number
258345)*



User's Guide

Graphics contained within this publication are for representation only. Your unit might differ.

Initial setup ...

Fitting the battery beneath your player



The RB-LiP01 battery has 3 locating pegs and 2 retaining brackets. These must be inserted into the player's 3 holes and 2 slots respectively.

Install the battery beneath the player using the locating pegs and retaining brackets intended for this purpose:

1. Lay the battery down flat as shown in the illustration.
2. Place the player on top of the battery so that the battery's locating pegs fit into the fixing holes (□) on the underside of the player.
3. Slide the player backwards on the battery until it clicks into place.

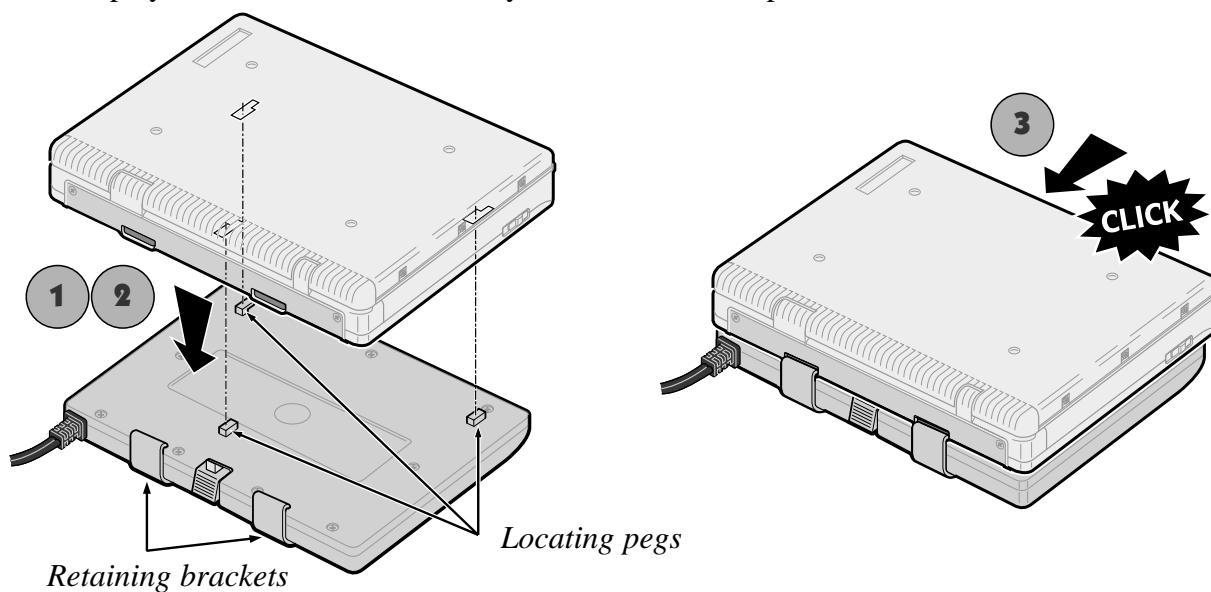

Initial setup of your remote control

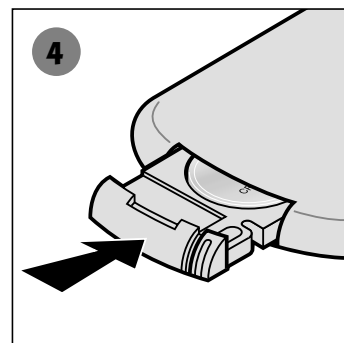
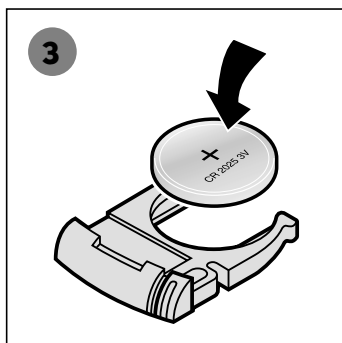
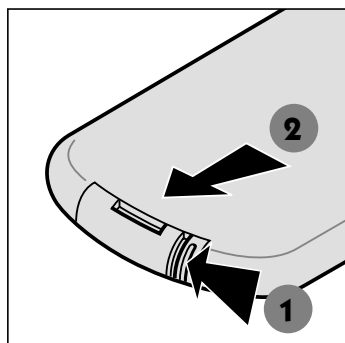

Fit the CR 2025 battery into the remote control unit as indicated.



In order to avoid any risk of explosion, observe polarities indicated inside the battery compartment. Replace only with the type of batteries specified above. Do not throw them into fire, do not recharge them. If you are not using the remote control unit for an extended period (several weeks), take the battery out.

The player's power supply

 You can power your player either from the power adapter or from the battery. The battery must first be charged using the power adapter.

Using the power adapter

1. Connect the output from the power adapter to the player's DC IN socket.
2. Connect the power adapter's supply cable to an AC power outlet.

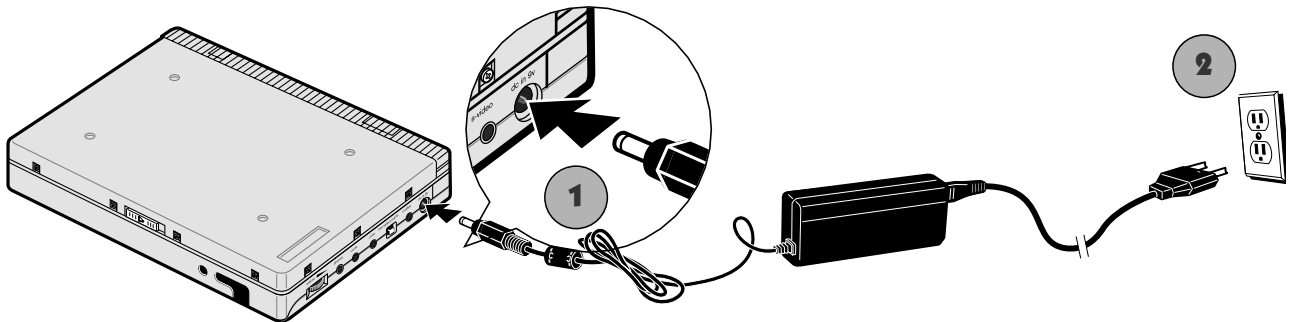

Using the battery

1. Install the battery as explained on page 5.

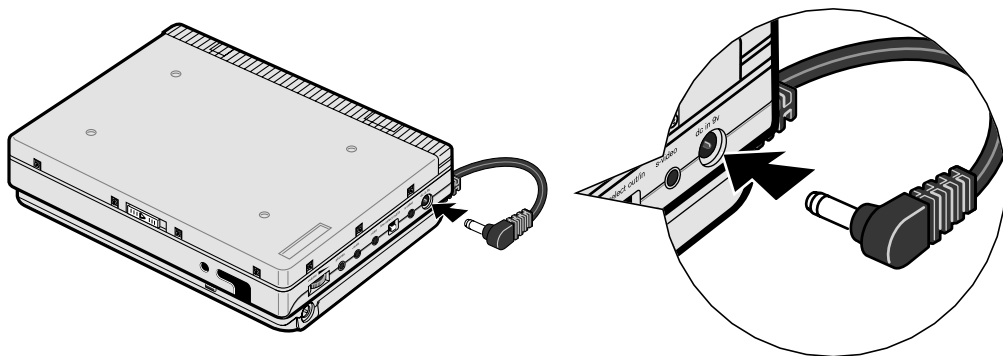

Charging the battery

1. Connect the output from the power adapter to the battery's DC IN socket. A red warning light will come on. This light will go out once the battery is fully charged.

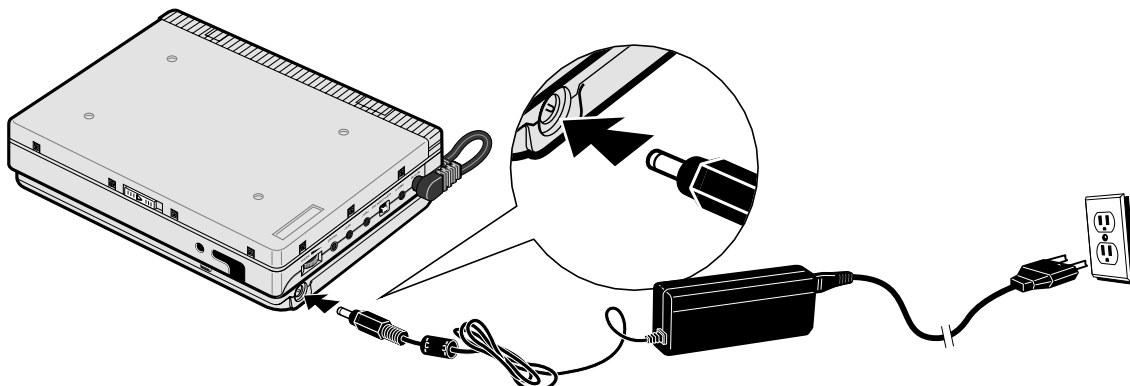

Other connections

Connecting the player to a television set

If you wish to use your portable player for home viewing, you can connect it to a television set using the Audio-Video cables supplied.

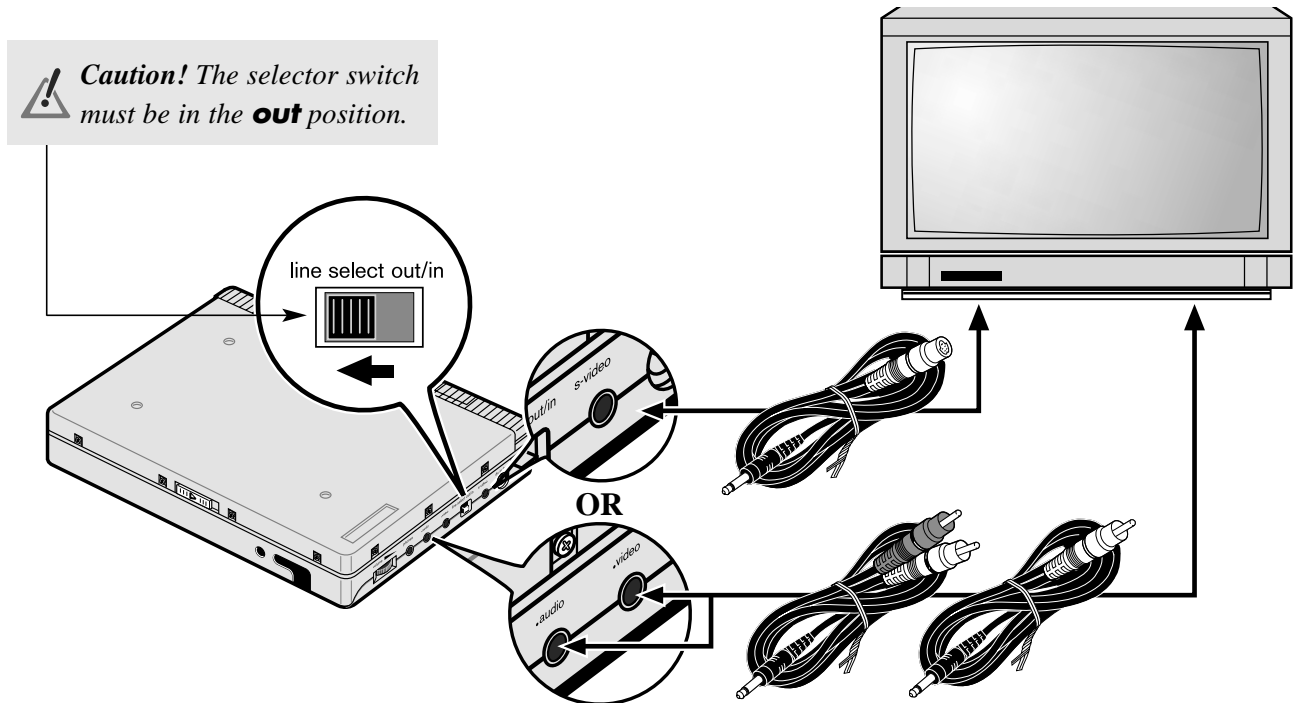

Using headphones

For private listening, use the **phones** jack to connect a headset to the player.

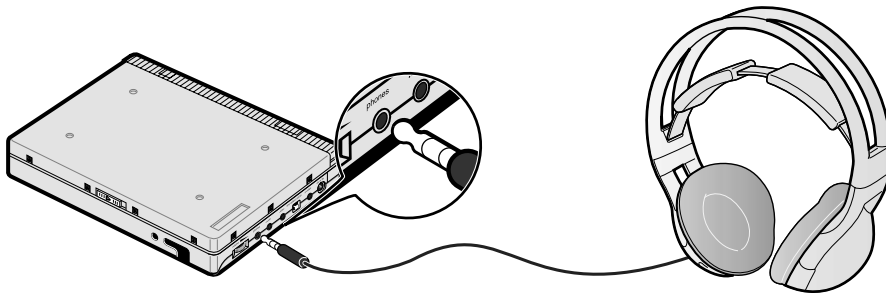

Connecting Audio-Video output to the player

If you want to use the player's built-in LCD screen ⁽¹⁾ to watch pictures from an external source (camcorder, VCR, etc.), use the Audio-Video cables supplied and set the **Line select** switch to the **in** position.

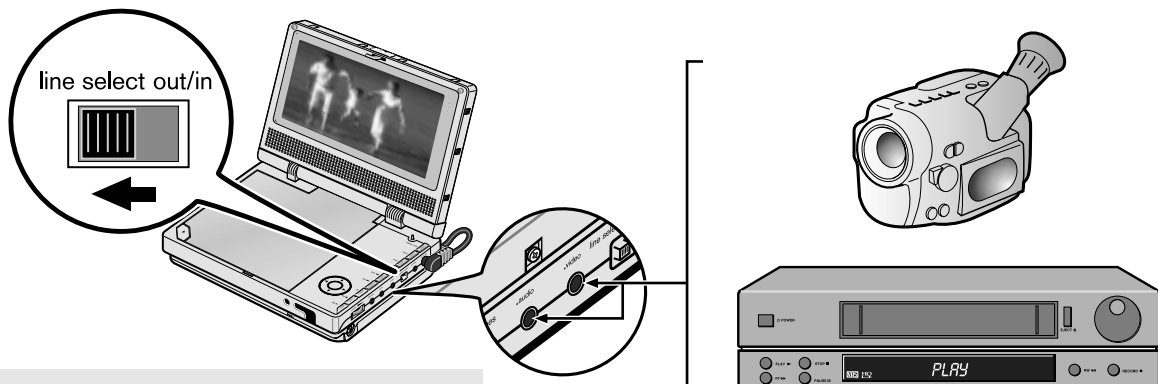

1. LCD- Liquid Crystal Display

Using your DVD player

Preparation

- Sit the player on a table or on a steady surface.
- Unlock the screen by pushing the locking clip to the right.
- Raise the screen to the open position.

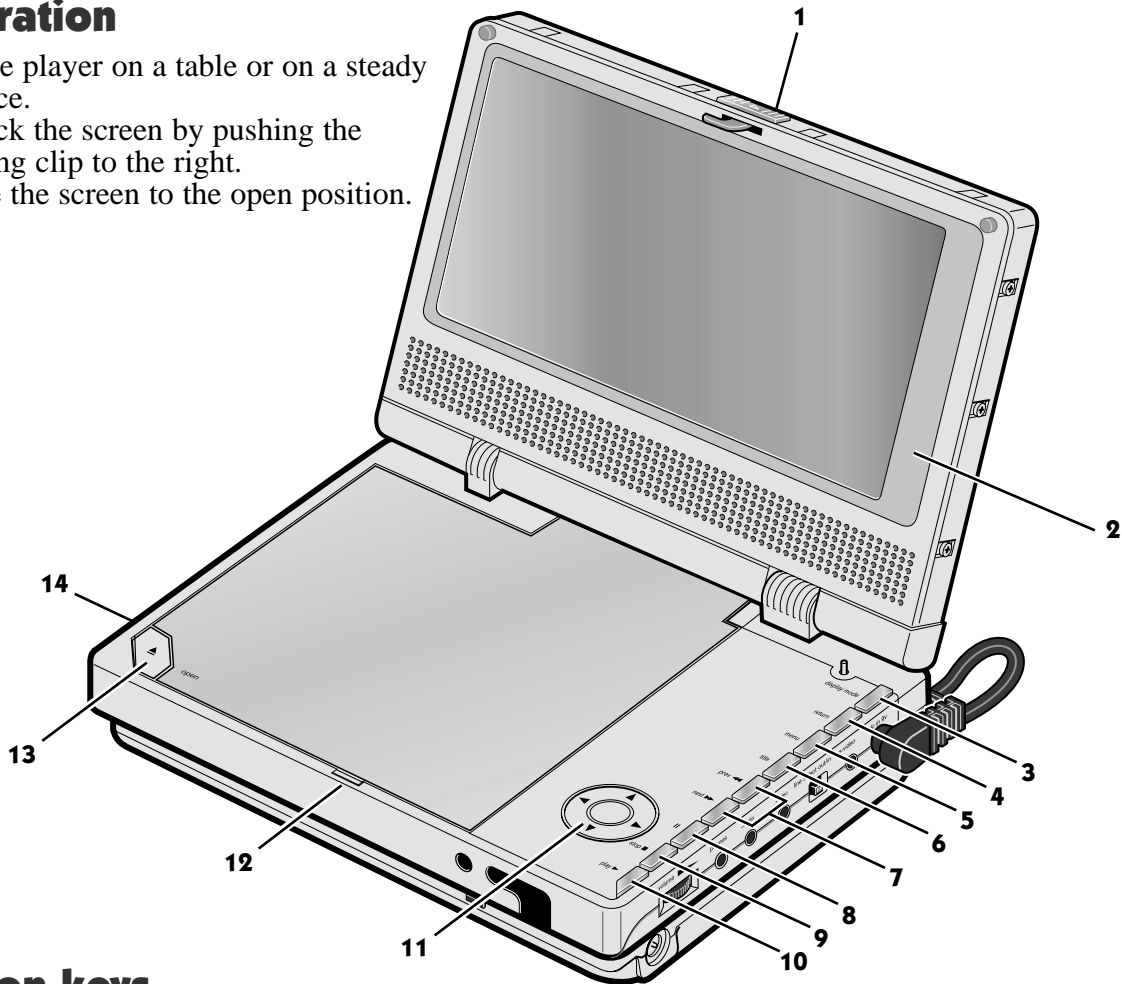

Function keys

1. Locking clip.
2. LCD screen.
3. **display mode**: adjusts brightness, color, or picture format. Press the **display mode** key repeatedly then use the player's ◀ or ▶ key (11) to make your adjustment.
4. **return**: returns you to the previous menu or hides a banner
5. **menu**: accesses disc menu.
6. **title**: displays the contents of a DVD.
7. **prev** ◀◀, **next** ▶▶: fast forward or backward.
8. **II**: pauses playback.
9. **stop** ■: stops playback.
10. **play** ▶: plays the disc.
11. Confirmation (●) and **Navigation** keys.
12. Disc compartment.
13. **open** ▲: opens the disc compartment flap.
14. **on . power . off**: turns the player on or off.

Jacks and controls

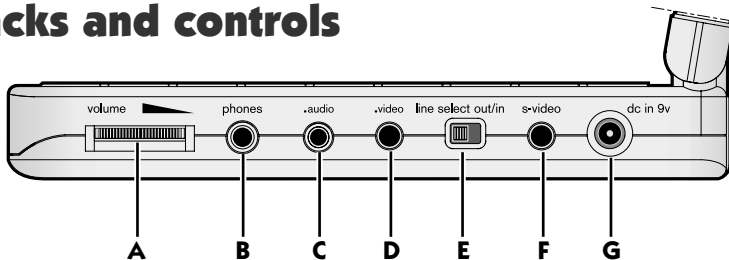



* You can purchase an audio cable that has a digital optical connector on one end and the mini-plug on the end that connects to the player (go to p.27 for information). The audio cable that came with your player carries analog sound and can be connected here as well.

- A. Volume adjustment.
- B. Headphone jack (PHONES).
- C. Audio jack* (optical or analog cable)
- D. Video jack
- E. Line Select out/in switch
- F. S-Video jack
- G. DC IN 9V jack for connecting the battery or power adapter.







Graphics contained within this publication are for representation only. Your unit might differ.

Remote control

Display keys

-  To activate or hide the function banners (page 11).
-  Access to the SETUP MENU (page 10).

Disc drive keys

-  Stop disc playback.
-  Pause disc and/or switch to advanced frame-by-frame mode (DVD).
-  Slow motion playback. Press several times to change playback speed and direction.
-  Skip forward/back one chapter (DVD) or track (CD).
-  Fast forward/reverse playback.
-  Start playback or confirm menu choice (acts like an OK or Select button).



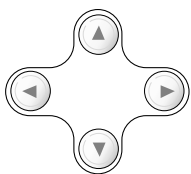

Navigation keys



Highlights items in a menu or banner.

-  Clear a banner from the screen.

DVD - Menu and language

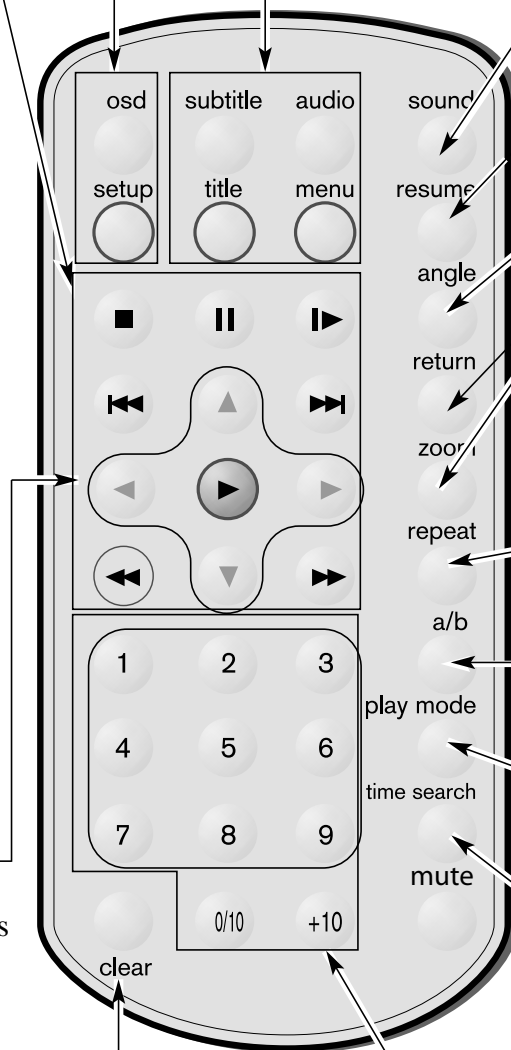

-  To display and change the subtitle* language.
-  To display and change the dialogue* language.
-  To see the table of contents of certain DVDs*.
-  To see the disc menu of the DVD being played.







Choice of disc sound channel (Stereo, left channel, right channel, Mono L & R).

No function.

DVD

-  To change a DVD's camera angle*.
-  No function
-  To enlarge or shrink the picture during playback/slow-motion/pause.

DVD-VCD-Audio CD

-  To repeat a title, a chapter, a track, or a disc.
-  To repeat a section between two points (A and B).
-  Choice of playback mode:
 - Random
 - Programmed
-  To go directly to a given chapter or exact point on the disc (access to the counter).

Number keys

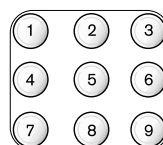

To program the order in which a disc's chapters (or tracks) are played, or to enter a time (access to the counter).



0/10: to enter zero (0) keys.



To enter numbers greater than 10.

 * If available on the disc being played.

 The **resume** and **return** keys are unused.

Menus...

 The functions of your DVD player are not all accessible directly through the remote control or front panel keys. A certain number of functions are accessible through menus that you can display or remove as you wish. These menus are used as follows:

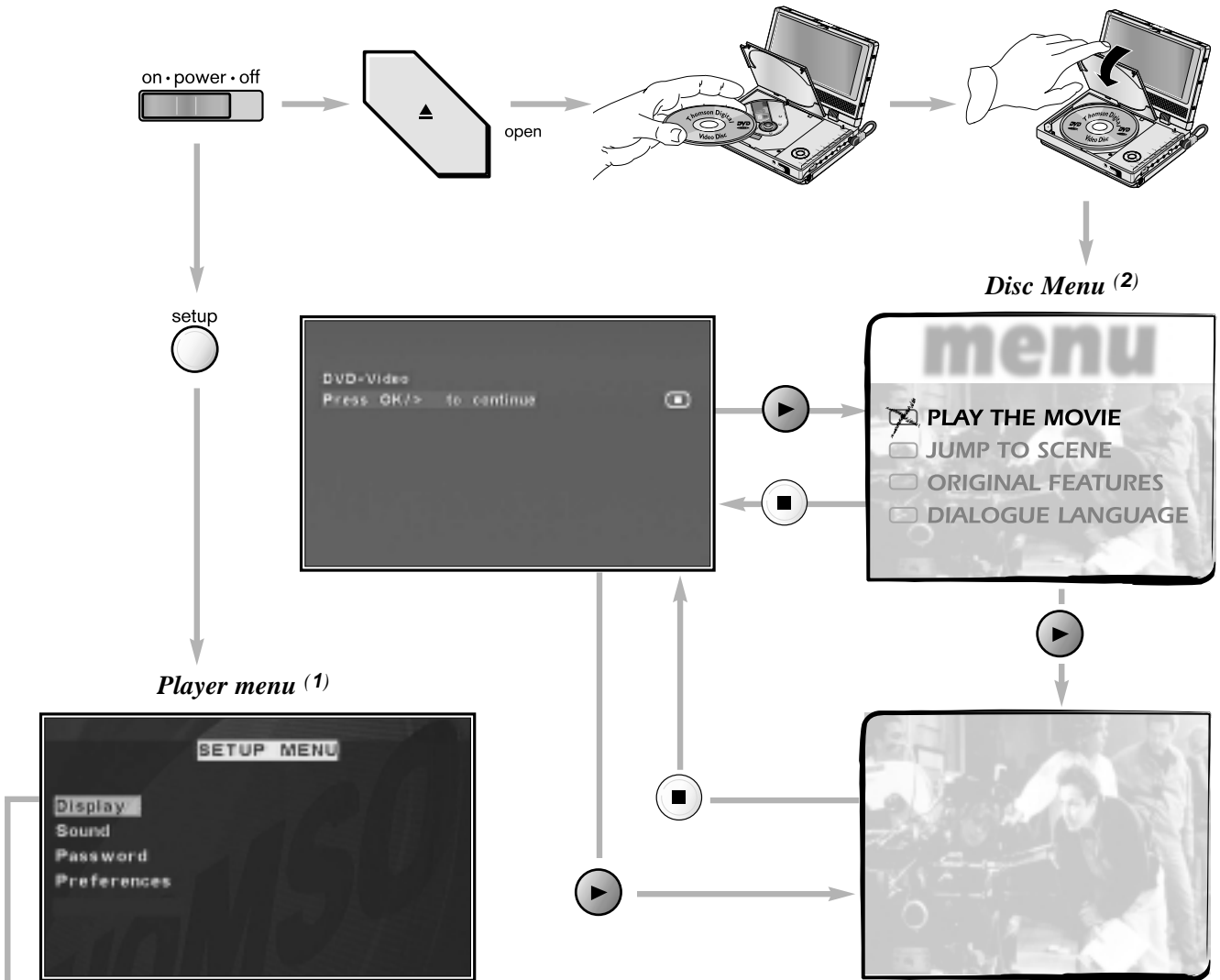

 **1.** The **SETUP MENU** enables you to configure the player (languages of the menus and disc, audio outputs, display modes), to choose the Play mode and lock the player.

 **2.** The appearance and contents of the menu vary according to the DVDs (follow on-screen instructions).

Selecting menu functions and options using the remote control Navigation keys

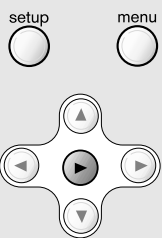

- 1.** Display the **SETUP MENU** with the **setup** key or display the disc menu (when a DVD is playing) with the **menu** key.
- 2.** Select a menu or function by pressing the **Navigation** key.
- 3.** Confirm your choice by pressing the  key located in the center.
- 4.** Change Settings, by pressing the **Navigation** keys.
- 5.** To exit the disc menu or setup menu with the **menu** or **setup** key respectively.

and interactive banners

 In addition to menus, your player also has banners which display the main settings related to disc playback and operation.

1. Load a disc and press ► (playback) to start it playing.
2. Press the **osd** key to display the banner.
3. Use the **Navigation** keys to select an icon or enter a numeric value via the number keys to access a chapter or title when the corresponding icon is highlighted.
4. Remove the banner with the **osd** or **clear** key.

With a DVD



The OSD banner for a DVD-Video disc shows the following icons and functions:

- Title icon:** To choose a title when a DVD has several titles.
- Chapter icon:** To choose a chapter.
- Subtitle icon:** To choose the subtitle language.
- Language icon:** To choose the dialogue language and the sound format that goes with it.
- Camera angle icon:** To change a DVD's camera angle.
- Repeat icon:** To repeat the playback of a title, chapter, track, scene or entire disc.

The banner also displays "DVD-Video" at the top left and "0:00:21" at the top right. Below the icons, it shows "Title 01/03" and "chapter 01/29". An "osd" key icon is shown on the left with an arrow pointing to the banner.

With an audio CD

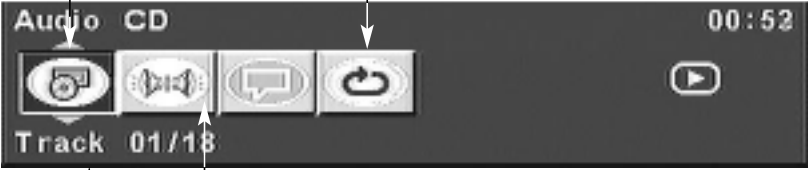

The OSD banner for an Audio CD shows the following icons and functions:

- Track icon:** Track 1 currently being played.
- Audio channel icon:** To select the audio channel (Stereo, Left, Right).
- Language icon:** To select a language from the available languages on a disc.
- Repeat icon:** To choose repeat playback of a disc, track, or section, or to activate programmed playback (→ page 16).

The banner also displays "Audio CD" at the top left and "00:52" at the top right. Below the icons, it shows "Track 01/18".

With a VCD (Video CD)

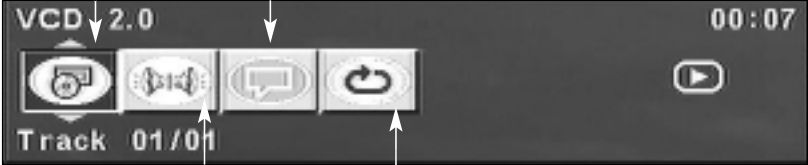

The OSD banner for a VCD 2.0 shows the following icons and functions:

- Track icon:** Track 1 currently being played.
- Audio channel icon:** To select the audio channel (Stereo, Left, Right).
- Language icon:** To select a language from the available languages on a disc.
- Repeat icon:** To choose repeat playback of a disc or track. Press the remote control unit's **a/b** key with the icon highlighted.

The banner also displays "VCD 2.0" at the top left and "00:07" at the top right. Below the icons, it shows "Track 01/01".

Display and Sound menus



The **Display** menu provides adjustments for changing the **picture format** and **TV standard** to that of your player's built-in LCD screen or to that of an external TV set connected via the Audio Video jacks. You can also choose which language to use for displaying the various setup menus.

The **Sound** menu provides settings to adjust your player's sound output according to your usage conditions and/or any connected components.

1. Display the **SETUP MENU** by means of the **setup** key.
2. The **Display** item is highlighted.
Press the ► (playback) key to display the **DISPLAY MENU**.
3. Select a function using the ► (playback) key.
4. Confirm using the ► (playback) key.

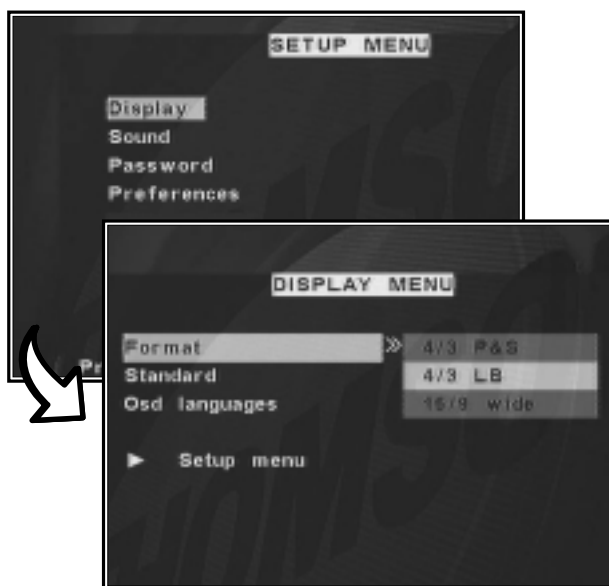

Format (screen format)

Depending on the properties of the DVD ⁽¹⁾ being played, choose a picture format to match that of your player's built-in screen or that of an external TV set ⁽²⁾ connected via the Audio Video jacks. Wide 16 x 9 screen, standard 4 x 3 screen (**LB** for letterbox or **P&S** for Pan and Scan). If you use your player's built-in screen, choose the 16 x 9 format.

4 x 3 P&S ⁽²⁾ – Choose this setting if you want the picture to fill your TV screen. This might mean certain parts of the picture (left and right edges) are hidden.

Most discs recorded with a wide-format picture cannot be rescaled this way. As a result, black bands appear at the top and bottom of the screen.

4 x 3 LB – Choose this setting if you want to see films in their original picture format (width/height ratio). You will then see the whole of the filmed image, but it might not fill the whole height of the screen. The picture might be surrounded by black bands at the top and bottom of the screen.

16 x 9 wide – Choose this setting if your DVD player is connected to a wide-screen 16 x 9 TV. If you select this setting for use with a standard TV set, the picture could be deformed due to vertical flattening.

If you watch a film on a wide-screen 16 x 9 TV and the disc is recorded in 4 x 3 format, the left and right edges of the screen will contain black bands.



^{1.} On certain DVDs, the picture format cannot be changed.



^{2.} Horizontal black bands at the top and bottom of the screen.

Graphics contained within this publication are for representation only. Your unit might differ.

Display and Sound menus

Setup menu language

Your player gives you several languages to choose from when displaying the various setup menus.

- Use the **Navigation** keys to select your desired language.
- Quit the setup menus by pressing the **setup** key.

Sound menu

1. Display the **SETUP MENU** by means of the **setup** key.
2. The **Display** item is highlighted.
3. Use the **Navigation** keys to select the **Sound** item.
4. Press the ► (playback) key to display the **SOUND MENU**.

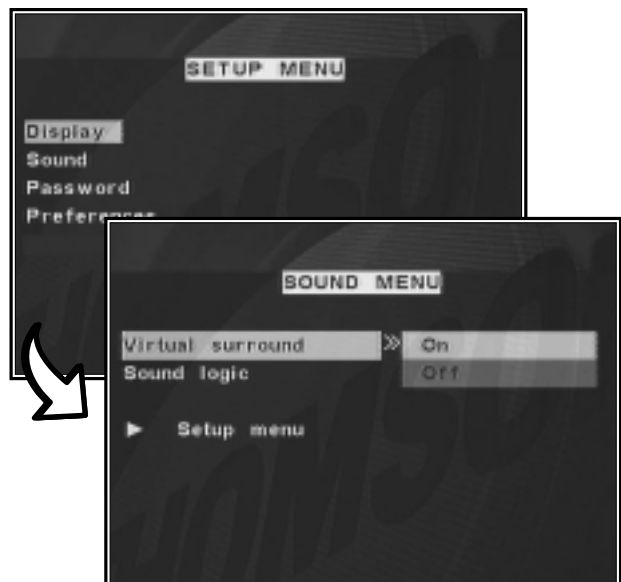

Virtual Surround

This function simulates the effects of multichannel sound from the 2 speakers situated under your player's built-in screen. Activating this function will give fuller depth to the DVD's sound track.

- Select **Virtual Surround** then highlight **On**.

Sound Logic

This function is designed for night listening if you wish to avoid disturbing your neighbors when your player is connected to a "Home Cinema installation". The player then adjusts the differences in sound levels through dynamic compression. It then becomes easier to hear the soft sounds while the louder sounds are softened.

- Select **Sound** then **Sound Logic** and switch the function to **On**.
- Quit the setup menus by pressing the **setup** key.

Basic functions

Loading a disc

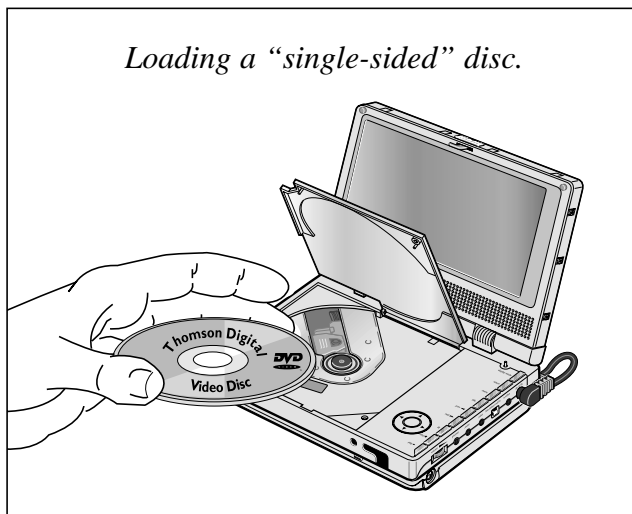

1. Press the **open**  key to open the disc compartment.
2. Insert a disc and locate it on the rotary spindle by applying pressure around the edge of the disc's center hole. The printed side of the disc should face upwards (Audio CD, Video CD, single-sided DVD ⁽¹⁾, etc.).
3. Push the flap down until it clicks.

 **1.** Double-sided discs have a small label on both sides near the center. With most DVDs, a disc-specific menu appears. In that case, follow the instructions.

Playing a disc

Playback begins as soon as the flap is fully closed.

- With a DVD, the disc menu appears. Press **▶** (playback) to start playback or select another option ⁽⁴⁾, in the disc menu using the **Navigation** keys. To validate your selection, press **▶** (playback).
- With an audio CD or video CD, use the **▶** (playback) key to start it playing.

To go to a chosen track on a CD, or to a title or chapter on a DVD, press the **osd** key which brings up a banner on the screen (→ page 11).

To stop playback momentarily ⁽²⁾ press **stop**  once. Press twice to stop it completely ⁽³⁾.

 **2.** The player has memorized the last scene on the disc. If you now press **▶**: playback starts from this point. To erase "**Resume memory**", press **stop** .

Resume memory does not work with interactive discs (without elapsed play time information).

 **3.** If the player is left in STOP mode for more than 2 minutes without any user interaction, a screen saver will be activated (fade in / fade out). After about 30 minutes have elapsed in STOP mode without user interaction, the player will be automatically switched off.

 **4.** Depending on the DVDs, it may be possible to change the language during playback (→ page 22).

Graphics contained within this publication are for representation only. Your unit might differ.



Quick search for pictures or tracks

In Play mode, start the Forward or Reverse fast motion playback ⁽¹⁾ using the ◀◀ or ▶▶ keys.



Press once or several times for higher speeds.



• In search mode, no sound is heard on DVDs.

Still picture and frame advance (DVD and Video CD)

To playback frame by frame, press **II** (pause) repeatedly to advance the playback.

Slow motion (DVD and Video CD)

Press the remote control unit's **▶** key ⁽¹⁾ one or more times.



Press once or several times for higher speeds.

Direct access to a music track (audio CD)

In Play mode, enter the number of the track that you want to hear using the remote control number keys.

Titles, chapters, time elapsed, audio and subtitles

Some DVDs contain several titles. These titles correspond to films, documentaries or other programs. As a general rule, each title is divided into numbered chapters. An audio CD's music tracks correspond to the different songs recorded on it. You can access each track directly.

From the banner, you can access certain functions directly using the **Navigation** keys. Choose a title or a chapter (DVD), or a track (CD, VIDEO CD). Change the language of DVD dialogues or subtitles.

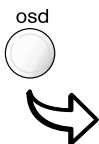

*This symbol is sometimes displayed.
It indicates that the function is not available or that the key used is incorrect.*

Play modes



Your player has several playback modes: **Standard playback**, which plays the tracks, titles, and chapters in the order found on the disc; **Random playback**, which plays sequences or tracks in no particular order; and **Programmed playback**, which lets you choose which sequences and tracks to play and in which order.

While a DVD or VCD is being played, press the **play mode** key on the remote control.

Standard playback

When a disc has been loaded, all you need to do is press the ► (playback) key to start it playing in the order intended by the publisher.

Random playback

When a disc has been loaded, press the **play mode** key once. **Random** appears on your player's built-in screen. Press the ► (playback) key to start playing the disc in random order.

Programming playback

When a disc has been loaded, press the **play mode** key twice. A programming window for the first 10 songs appears.

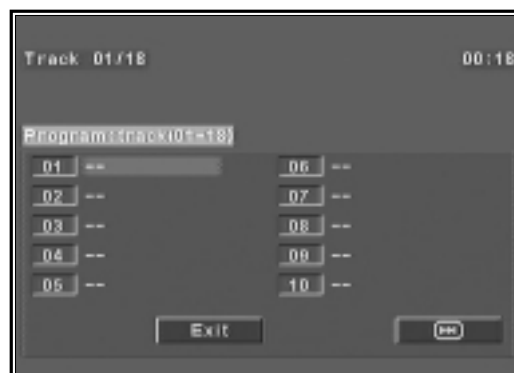

Enter the track numbers one by one.

If you want to include more than 10 songs in your programmed playback, press ► for access to a second programming window.

To begin playback, use the ▼ and ► keys to select **Start** and press ► (playback) to confirm. Programmed playback will then commence.

To cancel programmed playback, press the ■ (stop) key twice.

Graphics contained within this publication are for representation only. Your unit might differ.

Repeat playback



To repeat the playback of a title, chapter, track, scene, selected A/B segment (except on Video CDs) or entire disc.

Repeat play



While a disc is being played, press the **osd** key to display the function banner. Select the **Repetition Mode** icon  with the **Navigation** keys. Then use the **Navigation** keys to choose one of the displayed functions.

AUDIO CD / VIDEO CD	DVD
<ul style="list-style-type: none">• Disc Repeat• Title Repeat• Off	<ul style="list-style-type: none">• Chapter• Title• Disc Repeat• Off



- Repeat play only works with discs that show the elapsed time on the display.
- This may not work correctly with certain discs (Video CDs in PBC mode).
- Choose **Off** to stop the function.

Repeat playback between two points A and B

While a disc is being played, press the **a/b** key once to set the start point of the section to be repeated then once again to set the end point. The player's built-in screen will display  **AB** and playback of the section will begin.

To cancel repeat playback, press the **a/b** key or **■** (stop) key once.



- If during a fast forward or backward reading the **B** point is reached, the player will proceed at normal speed from the **A** point.
- If during a fast search the **A** point is reached, the player will start reading at normal speed from the **A** point.



- Repeat playback **A-B** is cancelled whenever you press **■** (stop) or choose a different repetition mode.

Other functions

DVD and Video CD - Zoom

To enlarge or shrink the picture (by a factor of 1 to 4), press the remote control's **zoom** key several times. To see other parts of the picture when it is enlarged, use the **Navigation** keys. To restore the picture to its normal size, press the **zoom** key several times.

DVD - Camera angles

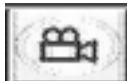

On certain DVDs, scenes may be recorded under various angles (up to 9 viewing angles). If so, an icon will appear on the screen.

While a disc is being played, press the **osd** key to display the function banner. Use the **Navigation** keys to select the camera angle icon.

If the banner indicates **Not available**, it means the disc does not have this feature.

Video CD - Playback control menu (PBC)

Some Video CDs ⁽¹⁾ have scenes and information which can be selected interactively through an on-screen menu.

This menu ⁽²⁾ appears when the disc is loaded. Use the remote control number keys to select an item in the menu.

- Depending on the disc, the menu may extend over more than one screen. To see the other screens, use the |◀◀ / ▶▶| skip keys.
- Some discs displaying a menu at start up will automatically go in to play mode if nothing is changed on the menu after a certain period of time.

Press ▶ to start playback.

- To return from playback to the menu, press **return**.

Press ■ (stop) to stop playback and remove the menu.

- Complete stop is obtained by pressing ■ (stop) key twice.
- Even after the player has finished playing a program, the disc may continue to rotate while the menu is displayed. When no further selections are to be played, press ■ (stop) to exit the menu.
- During playback, press **osd** key: info strip is displayed on-screen.

Pedigree dogs	
1	Collie
2	Terrier
3	Bobtail
4	Shepdog
5	Husky



1. Video CD, version 2.0 with playback control (PBC). When the PBC function is present on the disc, "PBC" is printed on the disc jacket.



2. Some version-2 Video CDs with PBC may not have an on-screen menu. In that case, they function like version-1.1. video CDs or audio CDs.

Graphics contained within this publication are for representation only. Your unit might differ.

Reading JPEG and MP3 files

Reading JPEG files



This DVD Player can play discs with JPEG files on it. Make sure the resolution of the JPEG files is less than 2 megapixels (2M).

Note: Depending upon the size and number of the JPEG files, it could take a long time for the DVD player to read the disc's contents. If you don't see an on-screen display after several minutes, some of the files are too big — reduce the resolution of the JPEG files to less than 2 megapixels and burn another disc.

When you play a JPEG disc, a JPEG menu is displayed. Use the Navigation keys to select a picture or folder (if there are any) then confirm your choice with B (playback).



- No banner is displayed when JPEG image files are being shown.
- If the picture appears upside down or on its side, press the **||** (PAUSE) key.



- If JPEG or MP3 files are recorded on the disc or the disc is a Video CD containing JPEG image files, a contextual menu is displayed.

What's MP3?

MP3 is the audio **file format allowing** you to easily compress music recordings, and was **co-developed** by Thomson multimedia.

The main advantage of MP3 is that it enables storage of CD-quality music tracks on a home computer in manageable, compressed files.

Thanks to compression you now only need about 4 Mb of disc space for a 4 minute music track, compared with some 40 Mb for conventional file formats, but with almost no reduction in listening quality!

MP3 CD Playback

When you play an MP3 disc, an MP3 menu is displayed. The DVD player menu is not available when playing MP3 discs. MP3 content is divided into album(s) and songs. A disc may hold several albums and each album can contain several songs. (Similar to titles and chapters on a DVD disc.)

- Use the remote control **Navigation** keys to select albums and songs.
- As computer files, several levels (several albums) may be recorded on a disc.



Song skip

- Press repeatedly on the **▶▶|** or **|◀◀** keys to go to the previous song or to the next one. Press as many times as the number of songs you want to skip (wait a few seconds after each press).

Parental Control



To activate your player's **Parental Control** feature, you must enter a password. The **Parental** feature lets you control the type of disc or program you want to let your family watch. If a disc contains certain information or scenes that are outside your selected limit, they will not be played. There are 8 levels of parental control, level 1 being the least restrictive.

1. With **SETUP MENU** displayed, use the **Navigation** keys to select **Password**.
2. Press the ► (playback) key to confirm.
3. Select a function using the **Navigation** keys,
4. Adjust the setting using the **Navigation** keys.



Setting a password

1. Select **Change** and press ► (playback) to confirm; the **PASSWORD CHANGE** window will appear.
2. Use the remote control unit's **number** keys to enter the 5 figures ⁽¹⁾ of the current password.
3. Enter the new password.
4. You will be asked to confirm the password. Repeat the operation.
5. Activate the Parental Control feature by selecting the **Password mode** menu item then choosing **On**.
6. You will be asked for your password.
7. Enter the password and press ► (playback) to confirm.



Choose 5 figures you can easily remember, or else note them down here.

--	--	--	--	--



If you've forgotten your password, consult the **Troubleshooting** guide at the end of this manual (→ page 24).

DVD - Ratings limits ⁽²⁾

To set a ratings limits, the Parental Control feature must be turned off. If the **Parental** menu item is displayed brightly, this means Parental Control is turned on ⁽³⁾.

1. Display the **SETUP MENU** by pressing the **setup** key.
2. Select the **Preferences** menu item and press ► (playback) to confirm.
3. Select **Parental** and press ► to confirm.
4. Use the ▼▲ keys to select your restriction level and press ► (playback) to confirm.
5. Quit the menu by pressing the **setup** key.



This function is only available on DVDs for which the publisher has set a rating limit. It therefore depends on the disc.



To turn Parental Control off, choose **Password** from the **SETUP MENU**. In the **PASSWORD** menu, first select **Password mode** then set this feature to **Off**.

Preferred languages (DVD)



Your player gives you a selection of languages to choose from. You can change the language of the player menus, the language of the disc menus, the language of the dialogues and that of the subtitles. Choose your preferred dialogue and subtitle language from the **Preferences** menu. If the feature is available on the DVD currently in your player, this item will be already selected (→ page 12). During playback, you can display or remove the subtitles and change the language of the subtitles using the banners (→ page 11).

Display the **SETUP MENU** by means of the **setup** key.

1. Use the **Navigation** keys to select **Preferences**.
2. Press the ► (playback) key to confirm.
3. Select a function using the **Navigation** keys,
4. Adjust the setting using the **Navigation** keys.

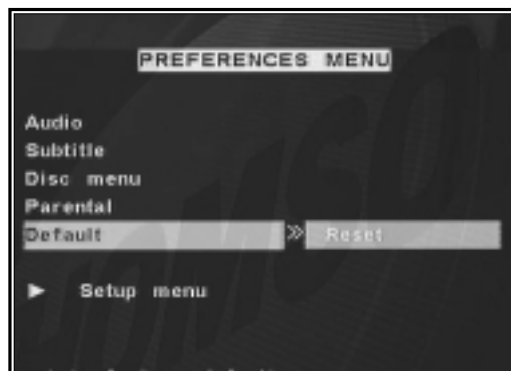

- If there is no English on the disc for menus, dialogues, and / or subtitles, the player selects the default language of the disc.
- If you select the **Default** item and confirm **Reset** as your choice, the setup menu will revert to English and all the adjustments you have made to all the settings since installing the player will be cancelled. The player will then be configured the way it was at delivery (factory settings).

Language of player menus

Depending on the DVD being played, you may be able to choose the language in which the disc menus are displayed.

The player itself comes with a choice of six languages. If the player language you have set corresponds to one of those available on the DVD, the disc menus will automatically appear in this language.

If there is no corresponding language on the disc, the disc menus will be displayed in the publisher's chosen language (usually English).

1. Display the **SETUP MENU** by means of the **setup** key.
2. Select **Preferences** then **Disc menu**.
3. Access the list of available languages with the ► key.
4. Use the **Navigation** keys to choose one of the available languages.
5. Press the ► (playback) key to confirm.
6. Quit the menus by pressing the **setup** key or else use the **Navigation** keys to choose another setting.



The setup menu language can be changed from the Display menu (→ page 12).

Graphics contained within this publication are for representation only. Your unit might differ.

Preferred languages (DVD)

Language of the dialogues

Some discs offer a selection of languages for the dialogues.

To change the language of the dialogues, your player offers you two possibilities ⁽¹⁾:

From the **SETUP MENU**

1. While in **STOP** mode, display the **SETUP MENU** by pressing the **setup** key.
2. Use the **Navigation** keys to highlight the **Preferences** item.
3. The **Audio** item will appear preselected; use the **▶** key to access the list of available languages ⁽²⁾.
4. Adjust the setting using the **Navigation** keys.
5. Press the **▶** (playback) key to confirm.

From the interactive banner



During **PLAYBACK**, display the banner using the **osd** key and select the **Audio** () icon with the **Navigation** keys. Choose one of the languages available on the disc.



With DVDs which have a DVD menu, we recommend that you use the disc menus rather than the player menu.

*You can also change the language of the dialogues and subtitles (if they are available on the disc). During playback, display the disc menu using the **menu** key. Then use the navigation keys.*



If the language chosen is also available on the DVD, it will be selected as the dialogue language. If it is not available, the preferred disc language will be selected.

Original corresponds to the original soundtrack language of the film on the disc.

Language of the subtitles

Some discs offer a selection of subtitle languages. To change the language of the subtitles, your player offers you two possibilities ⁽¹⁾:

With DVDs which have a DVD menu, we recommend that you use the disc menus rather than the player menu.

From the **SETUP MENU**

1. While in **STOP** mode, display the **SETUP MENU** by pressing the **setup** key.
2. Use the **Navigation** keys to select first **Preferences** then **Subtitle**.
3. Access the list of available languages ⁽²⁾ using the **▶** key.
4. Adjust the setting using the **Navigation** keys.
5. Press the **▶** (playback) key to confirm.

From the interactive banner



During **PLAYBACK**, display the banner using the **osd** key and select the **Subtitles** () icon with the **Navigation** keys. Choose one of the languages available on the disc.

CD-Rs and MP3 files (Recommendations)⁽¹⁾

About CD-R discs



This unit can play most CD-R discs. However, depending on the condition of the CD-recorder, computer and the disc used, you may find that not all discs will play successfully. When playing a CD-R disc, it is completely normal for the unit to take up to 20 seconds to recognize the disc before starting to play. If the disc is not recognized after a period of 20 seconds, remove the disc, and then insert it again. If after several trials, this disc cannot be recognized, make sure you have followed the recommendations below or try another type of disc. There are two main types of recordable CDs:

- *CD-R audio discs (for music only), which should be used when recording with Hifi CD-audio recorder.*
- *CD-R Data discs are designed for recording via a CD writer on a personal computer. Use these discs as a preference.*

- As a preference, opt for CD-Rs instead of CD-RWs (rewritable CDs) as, in certain cases, CD-RW playback may be faulty.
- As a preference, opt for 74-min (650 Mb) CD-Rs instead of 80-min (700 Mb) CD-Rs.
- Close all other applications on the computer to ensure reliable CD-R disc recording.
- Use reliable, good-quality CD writing software.
- Whatever the real recording capacity of the CD-R, do not use more than 630 Mb of recording space on the disc.

Make sure that the recording is “long enough” to be played. If the recording is too short, disc identification time may be increased.

About MP3 files copied on to CD-Rs



In the case of CD-R MP 3 discs, please follow all the recommendations for CD-R above, plus the comments below:

Format

- **Your MP3 files should be ISO 9660 or JOLIET format.** ISO 9660 format and Joliet MP3 files are compatible with Microsoft’s DOS and Windows, and with Apple’s Mac. These two formats are the most widely used.

Name

- **When naming your MP3 files do not exceed 12 characters, and place “.mp3” as the file extension.** General name format of: Title.mp3. When composing your title ensure that you use 8 characters or less, have no spaces in the name, and avoid the use of special characters including (. , / , \ , = , +).

Compression

- **Use a decompression transfer rate of at least 128 kb/sec (kilobytes/second) when recording MP3 files.** Sound quality with MP3 files basically depends on the rate of compression/decompression you choose. Getting audio CD quality sound requires an analog/digital sampling rate, that is conversion to MP3 format, of at least 128 kb/sec and up to 160 kb/sec. However, choosing higher rates, like 192 kb/sec or more, only rarely give even better sound quality. Conversely, files with sampling rates below 128 kb/sec will not be played properly.

Protection

- **Do not try recording copyright protected MP3 files.** “securized” files are encrypted and code protected to prevent illegal copying. These files are of the following types: Windows Media™ (registered trade mark of Microsoft Inc) and SDMI™ (registered trade mark of The SDMI Foundation). You must not copy such files.



Important: *The above recommendations cannot be taken as a guarantee that the DVD player will play MP3 recordings, or as an assurance of sound quality. You should note that certain technologies and methods for MP3 file recording on CD-Rs prevent optimal playback of these files on your DVD player (that is degraded sound quality and even, in some cases, inability of the player to read the file or files).*

Troubleshooting guide

No power?

- Have you moved the player? Check the plug on the battery cable or power adapter: is it pushed firmly into the DC IN jack on the unit?
Check the plug on the power adapter; it too should be pushed in firmly.
- Is the power adapter connected to a live outlet? Try connecting another component to the outlet: does it work? If not, check the corresponding fuse or circuit breaker in your house's fusebox.

The remote control does not work?

- To operate your player, it must be turned on. On the front panel, is the green light on? Check that the off/on (power) switch on the side of the player is set to on. Your player will not work when the screen is folded away.
- Remember to point the remote control at the front of your player (towards the infrared sensor) rather than at another connected component (TV set, etc.).
- The operating range of the infrared control is 3 or 4 meters (approximately 9 to 12 feet). This distance becomes less as the battery wears out. This is a handy way of checking the battery state.
- Pay attention to any objects that might lie in the path of the infrared beam between the remote control unit and your player. They can obstruct the beam, causing the player to malfunction.
- The battery might be worn out. Replace it. Make sure the polarity of the terminals (+ and -) is correct.

The remote control unit and the player no longer work.

- Disconnect the DC IN plug from your player for a few seconds then put it back.

Picture problems

You don't see a picture.

- Switch your player on. Check that the line select switch on the side is set to "out" if you are playing a DVD or to "in" if you are watching video output from another component.
- If your player is connected to a TV set, make sure the video input channel selected on the TV corresponds to the input jacks you used to connect the DVD player to the TV.
- Check that all the various plugs are completely plugged in.

The colors don't seem natural.

- Check that all the various plugs are completely plugged in.

- Check the TV signal standard (auto, NTSC, PAL) in the image menu (page 13).

The picture format does not match the screen format.

- The picture format is adjustable (page 12). Some discs dictate the format, in which case no adjustment is possible.

Sound problems

No sound; weak or inaudible sound.

- Adjust the volume control on the side of your player.
- If a TV set is used, check whether the sound is muted or turned down low.

Menu problems

The menus and/or subtitles are not in your preferred language.

- With a DVD: the disc menus are not displayed in your language. Read the disc jacket to see what languages are available on that disc. Choose one that suits you if possible (page 21).
- With a DVD: there are no subtitles. Read the disc jacket to see if subtitles are available on that disc. Choose subtitles in a language that suits you if possible (page 22).
- The default language for dialogues and subtitles is liable to be preset by the DVD. To change it, follow the instructions on page 22.
- You can also change between languages while the disc is playing by pressing the **audio** dialogue and subtitle keys. This choice applies only to the disc being played.

Your player's setup menus are not displayed in the language you want.

- Check that your language is among those listed in the image menu (page 12). If necessary, choose another language.

You cannot access a menu.

- If the menu name is displayed in a lighter shade, then the menu items or corresponding functions are not available in the current working mode (Preferences or Parental Control).

If you have forgotten your Parental Control (locking) password, follow these instructions:

- Unlock your player with the universal code, 99999.

Limited Warranty

What your warranty covers:

- Defect in materials or workmanship.

For how long after your purchase:

- 90 days from date of purchase - Unit exchange, which includes parts and labor.
- 91 days to 1 year from date of purchase - Unit exchange, which includes parts only; you pay the labor.
- The warranty for rental units begins with the first rental or 45 days from date of shipment to the rental firm, whichever comes first.

What we will do:

During the initial 90 days: Exchange the DVD unit with a new or, at our option, refurbished unit.

After the 90 days and within one year: Exchange the DVD unit with a new or, at our option, refurbished unit. We will bill you a flat exchange charge to replace a defective unit. This charge covers the labor cost for its repair.

How you get service:

- Call 1-800-311-9263 and have your unit's date of purchase and model/serial number ready. The model/serial number information is on the back of your unit.
- A representative will troubleshoot your problem over the phone.
- If the representative determines that you should receive a replacement unit you will be provided with a Service Request (SR) number and the location of a nearby exchange point if one exists. No returns will be accepted without the SR number.
- Proof of purchase in the form of a bill of sale or receipted invoice which is evidence that the product is within the warranty period must be presented to obtain warranty service. For rental firms, proof of first rental is also required.

To receive a replacement unit before you return yours:

Option I:

1. Provide your Discover, MasterCard or Visa account number and expiration date to your phone representative. This is for security purposes only and your account will not be charged at this time.
2. We will send you a replacement unit.
3. If you return the unit to us within 14 days from the date you were provided a SR number, only items not covered by warranty will be charged to your account. If your unit is not received within 14 days, the suggested retail value of the unit will be charged to your credit card. This amount will be credited, less a handling fee, if the unit is subsequently received.
4. Ship your defective unit back to us using the replacement unit's carton. Shipping instructions will be included on the carton along with your SR number which will allow you to easily ship the unit back to us. Make sure you insure your shipment in case of damage or loss. Include with the shipment:
 - Evidence of purchase date such as a bill of sale.
 - A brief note describing your unit's problem.
 - Your name, address and phone number.

Option II:

1. For a fee, we will send a replacement unit to our exchange point.
2. The exchange location will notify you of its arrival.
3. Take your unit and evidence of purchase date, such as a bill of sale, to the exchange location and you will be provided the new or refurbished unit. Please retain all accessories such as the remote control hand unit.
4. If the repairs are covered by your warranty, you will not be billed.

Thomson assumes no responsibility for warranty shipments from the customer to the factory if not shipped in the manner prescribed by Thomson. Return transportation, storage, handling and insurance costs are your responsibility. We accept no responsibility in case of damage or loss.

To receive a replacement unit after we have received your unit:

- Write the SR number on the outside of the carton used to return the unit. Make sure you insure your shipment in case of damage or loss.
- Carefully pack the unit using the original box and packing material if possible. Please retain all accessories that were included with your unit such as the remote control hand unit.

Continued on next page....

Limited Warranty (continued)

- Include with the shipment:
 1. Evidence of purchase date, such as a bill of sale, to verify your unit's warranty eligibility.
 2. A brief note describing your unit's problem.
 3. Your name, address and phone number.
- The representative will advise the address to mail a cashier's check or money order for payment if there are any out of warranty labor or parts charges, and you elect not to use your credit card.
- After we receive your product, a new or refurbished unit will be shipped to you.

What your warranty does not cover:

- Acts of nature, such as but not limited to lightning damage.
- Adjustment of customer controls.
- Damage from misuse or neglect.
- A unit that has been modified or incorporated into other products or is used for institutional or other commercial purposes.
- Batteries.
- Units purchased or serviced outside the U.S.A.
- Shipping damage if the unit was not packed and shipped in the manner prescribed by Thomson.
- Storage fees may be charged by the exchange point if you fail to pickup the replacement unit in a timely manner.

Product Registration:

- Please complete and mail the Product Registration Card packed with your DVD product. It will make it easier to contact you should it ever be necessary. The return of the card is not required for warranty coverage.

Limitation of Warranty:

- THE WARRANTY STATED ABOVE IS THE ONLY WARRANTY APPLICABLE TO THIS PRODUCT. ALL OTHER WARRANTIES, EXPRESS OR IMPLIED (INCLUDING ALL IMPLIED WARRANTIES OF MERCHANTABILITY OR FITNESS FOR A PARTICULAR PURPOSE) ARE HEREBY DISCLAIMED. NO VERBAL OR WRITTEN INFORMATION GIVEN BY THOMSON MULTIMEDIA INC., ITS AGENTS OR EMPLOYEES SHALL CREATE A WARRANTY OR IN ANY WAY INCREASE THE SCOPE OF THIS WARRANTY.
- REPAIR OR REPLACEMENT AS PROVIDED UNDER THIS WARRANTY IS THE EXCLUSIVE REMEDY OF THE CONSUMER. THOMSON MULTIMEDIA INC. SHALL NOT BE LIABLE FOR INCIDENTAL OR CONSEQUENTIAL DAMAGES RESULTING FROM THE USE OF THIS PRODUCT OR ARISING OUT OF ANY BREACH OF ANY EXPRESS OR IMPLIED WARRANTY ON THIS PRODUCT. THIS DISCLAIMER OF WARRANTIES AND LIMITED WARRANTY ARE GOVERNED BY THE LAWS OF THE STATE OF INDIANA. EXCEPT TO THE EXTENT PROHIBITED BY APPLICABLE LAW, ANY IMPLIED WARRANTY OF MERCHANTABILITY OR FITNESS FOR A PARTICULAR PURPOSE ON THIS PRODUCT IS LIMITED TO THE APPLICABLE WARRANTY PERIOD SET FORTH ABOVE.

How state law relates to warranty:

- Some states do not allow the exclusion nor limitation of incidental or consequential damages, or limitations on how long an implied warranty lasts, so the above limitations or exclusions may not apply to you.
- This warranty gives you specific legal rights, and you also may have other rights that vary from state to state.

If you purchased your product outside the United States:

- This warranty does not apply. See your dealer for warranty information.

Graphics contained within this publication are for representation only. Your unit might differ.

Accessories

Accessory Information

There are accessories available to complement your DVD Player. Prices are subject to change without notice. All accessories are subject to availability.

A shipping and handling fee will be charged upon ordering, and we are required by law to collect the appropriate sales tax for each individual state, country, and locality to which the merchandise is being sent.

How to Order

To place an order by phone, have your Visa, MasterCard, or Discover Card ready and call the toll-free number listed below.

1-800-338-0376 (Use this number only to place an order for accessory items.)

You can buy some accessories on-line at www.rca.com

Note: Products shown might not be available from www.rca.com web site.



Optical Plug to Optical Plug for Optical Audio connection to a compatible receiver.

3 feet (DV3); price \$15.95

6 feet (DV6); price \$19.95



Optical Plug to Mini Plug

3 feet (DV3M); price \$15.95

6 feet (DV6M); price \$19.95

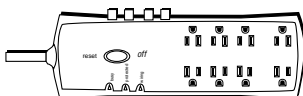

Surge Protector (SCTV 160), price \$49.95

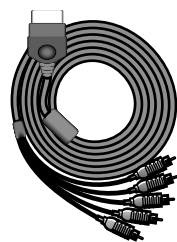

Component Video to VPORT cable (GP650XB), price \$29.95

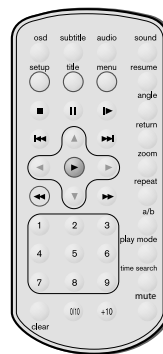

Remote Control (258343)
call or visit rca.com for pricing

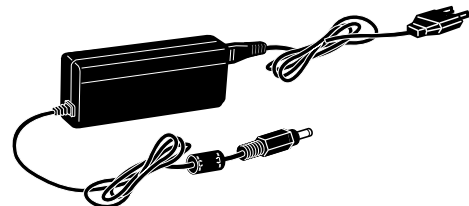

Power adapter and charger (258342)
call or visit rca.com for pricing

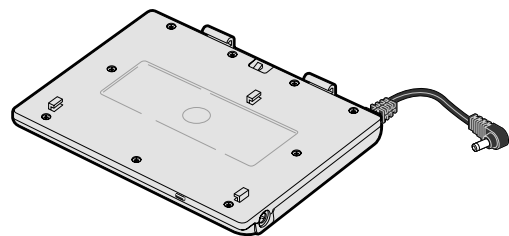

Battery RB-LiP01 (258341)
call or visit rca.com for pricing

Visit our website at www.rca.com

Please do not send any products to the Indianapolis address listed in this manual or on the carton. This will only add delays in service for your product.

Thomson multimedia Inc.

10330 North Meridian Street
Indianapolis, IN 46290

©2002 Thomson multimedia Inc.

Trademark(s) ® Registered

Marca(s) Registrada(s)

Printed in China

TOCOM 15909480

