

PWM-T210

Installation Instructions

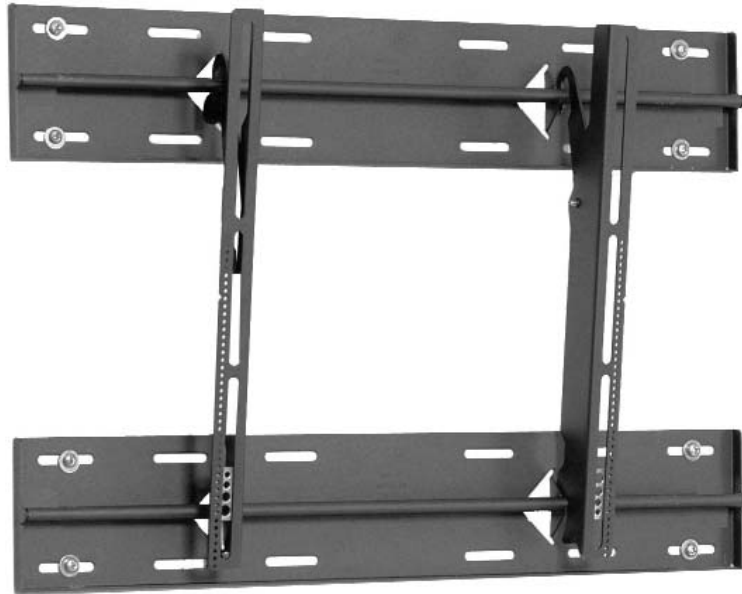

UNIVERSAL FLAT PANEL MOUNT

TABLE OF CONTENTS

Warning Statements	3
Parts List.....	4
Installation Tools	4
Locating the Center of the Display.....	5
Mounting Bracket Positioning	5
Securing the Mounting Brackets	6
Marking the Wall	7
Marking the Bottom Mounting Points	7
Securing the Lower Wall Plate	8
Securing the Upper Wall Plate	8
Mounting the Display.....	9
Securing the Display.....	10
Technical Specifications	11
Warranty	11
Contact Premier Mounts.....	11

Safety Precautions

This wall mount should be installed by qualified personnel having sufficient skill and competence to install it. Qualified installation specialists or your dealer should install the mount and set up the plasma display in order to avoid personal injury or property damage. Premier does not assume liability for injury or damage, including liability, caused by improper installation, mounting or setup of the plasma display, misuse, modification or natural disasters.

The entire installation instructions should be fully read and understood, including all of the safety symbols and safety precautions, before beginning installation. The installation instructions should be read, understood and followed to prevent personal injury or property damage. Keep these installation instructions in an easily accessible location for future reference.

The wall being considered for mounting must be capable of supporting at least five (5) times the weight of 40Kg. If it is not, the wall must be reinforced before beginning installation.

Only use specified parts for the installation of the mounting bracket. Do not use the mounting hardware from any other mount or any other source.

Warning Statements

The wall or ceiling structure must be capable of supporting at least five (5) times the weight of the plasma display. If not, the wall or ceiling must be reinforced. Proper installation procedure by qualified personnel as outlined in the installations instructions must be followed. Failure to do so could result in serious personal injury.

The entire installation instructions should be fully read and understood, including all of the safety symbols and safety precautions, before beginning installation. The installation instructions should be read, understood and followed to prevent personal injury or property damage. Keep these installation instructions in an easily accessible location for future reference.

 Handling by other than professional contractors is prohibited.

 Indicates that the power plug is to be disconnected from the power outlet.

 Disassembly of the plasma display is prohibited.

 Safety precautions must be taken at all times.

 Warning and caution in general.

 Contact Premier Mounts for any technical/installation questions.

Installation Location

 A secured structure wooden stud wall must always support the weight or load of the plasma display. Always confirm the center of the wood stud before beginning the installation. Failure to do so could result in personal injury and physical damage.

 Avoid installing the plasma display in locations where temperatures and humidity are excessively high, or contact with any water or vapors possible. This could result in fire, electrical shock and damage to the plasma display. Water will damage the wall structure for wall mount installation. The permissible temperature is (0-40°C) and humidity is (20%-80%).

 The mount is designed to be used on vertical walls only. Do not install near or on doors, angled ceilings, walls, or any other installations other than wall mounting. Failure to do so could result in damage and injury. This wall mount is to be used only with a Pioneer plasma display. Use with any plasma display other than Pioneer is prohibited and may cause injury and damage.

 Avoid Installations where there is danger of contact with over excessive dust, oil smoke, and tobacco smoke. Failure to do so may result in fire or damage to the plasma display or its internals.

 Make sure the plasma display mounting area is completely free of internal or external wires, pipes, gas lines, phone lines, etc. Failure to do so may result in injury and damage to the walls, wiring or piping system.

 Do not block the ventilation holes. Sufficient clearance must be left in the area surrounding the plasma display and wall mount to avoid blocking the vents and causing the plasma display to overheat which could cause a risk of fire. Leave 100mm or more away from all of the surrounding four sides for proper airflow.

 Do not install in locations where there is vibration, movement or danger of impact. Failure to do so could result in plasma display cracking or falling from the wall causing damage and injury.

 Do not install near heater, fireplace, direct sunlight or air conditioning or any other source of direct heat energy. Failure to do so may result in damage to the plasma display and could cause a risk of fire.

 It is not necessarily to open the plasma display prior to installation. Never open the plasma display or modify the mount. This mount is to be used only as outlined in the installation instruction. Failure to do so may result in damage and injury. If a malfunction or problem occurs with the plasma display, contact the nearest dealer or Pioneer.

Safety Precautions

 At least two qualified people should always perform the installation work. Injury and damage can result from dropping or bending the plasma display.

 All hardware must be firmly tightened and secured to the plasma display in the correct locations. If the hardware is not properly installed, do not hang the plasma display to the wall mount. Damage and injury could result from the plasma display falling down.

 All four (4) Lag bolts must be properly secured to the wall studs. The lag bolts must always be secured through the center of the wood studs. Failure to do so could result in the plasma display falling from the wall causing damage to the plasma display and personal injury.



 All bolts must be properly tightened and secured before installing the plasma display. Failure to do so could result in the plasma display falling causing damage to the plasma display and personal injury.

 Objects on the wall may collect dust quicker than anticipated. Check periodically for dust accumulation. Refer to the plasma display installation instructions for cleaning instructions.

 Do not play around the plasma display or throw any objects near or at the screen. The screen is very sensitive and may scratch or break or cause the plasma display to fall from the wall causing personal injury and damage.

Parts List

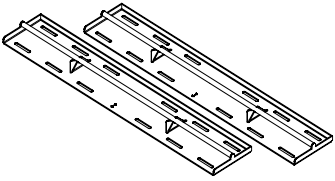
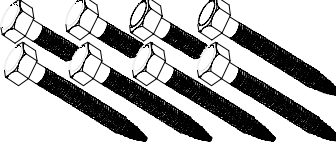
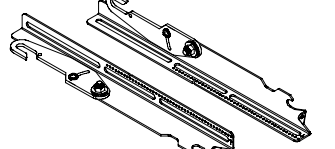
NOTE: This mount is shipped with all installation hardware and components. Make sure that none of these parts are missing and/ or damaged before beginning installation. If there are parts missing and/or damaged, please stop and contact Premier Mounts (800) 368-9700.

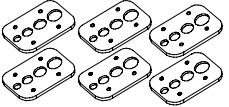
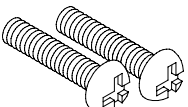
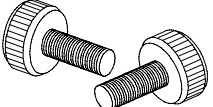
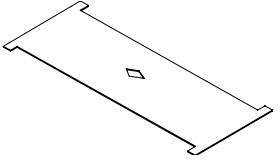
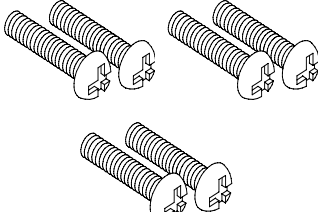
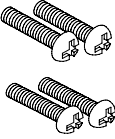
<p>Wall Plates (Qty 2)</p>		<p>5/16" x 3" Lag Bolts (Qty 8)</p>	
<p>Mounting Brackets (Qty 2)</p>		<p>5/16" Flat Washers (Qty 8)</p>	
<p>Griplates™ (Qty 6)</p>		<p>M6 x 30 Lateral Shift Locking Screws (Qty 2)</p>	
<p>M6 x 12 Safety Knobs (Qty 2)</p>		<p>Template (Qty 1)</p>	
<p>M8 x 20mm Phillips Head Screws (Qty 6)</p>		<p>M6 x 12mm Phillips Head Screws (Qty 4)</p>	

Installation Tools

Phillips Head Screw Driver Soft Material/ Blanket
 Tape Measure Drill Gun
 Stud Finder (Commercially Available)

1/2" Socket and Wrench Pencil
 Level (Supplied)
 1/4" Drill Bit

Locating the Center of the Display

CAUTION: Proper installation procedure by qualified personnel as outlined in the installation instructions must be adhered to. Failure to do so could result in serious personal injury and possible damage to the flat panel.

WARNING: INVERT THE FLAT PANEL PLACE IT ON A SOFT, FLAT SURFACE TO PREVENT DAMAGE TO THE FLAT PANEL. USE A BLANKET, FOAM, ETC. FAILURE TO DO SO WILL RESULT IN DAMAGING THE FLAT PANEL. DO NOT LAY THE FLAT PANEL ON THE FLOOR WITHOUT ANY PROTECTION TO THE GLASS. THE FLAT PANEL IS HEAVY AND FRAGILE. AT LEAST (2) QUALIFIED PERSONNEL ARE STRONGLY RECOMMENDED FOR INSTALLATION OF THIS PRODUCT. FAILURE TO DO SO COULD RESULT IN SERIOUS INJURY AND POSSIBLE DAMAGE TO THE FLAT PANEL.

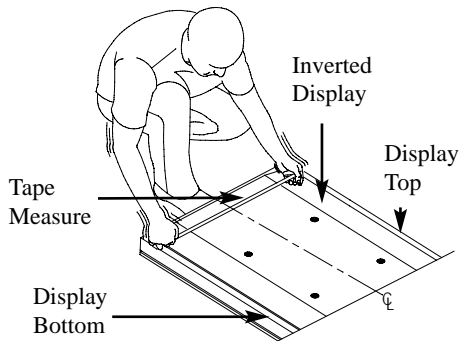

Figure 1

1. Once the flat panel is inverted, use a measuring tape to find the center of your flat panel measuring from outside to outside of the chassis (Figure 1).

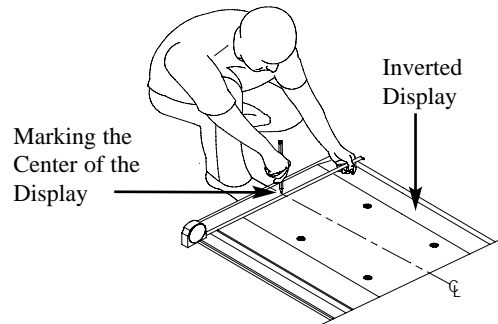

Figure 2

2. Using a pencil lightly mark the center of your flat panel (Figure 2).

Mounting Bracket Positioning

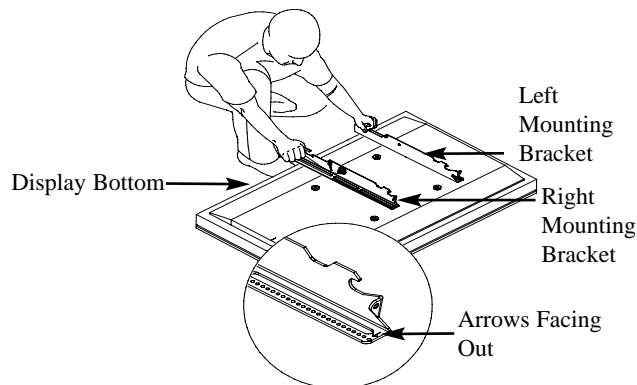

Figure 3

3. Lay the left and right mounting brackets over the mounting points, with the stamped arrows facing out (Figure 3).

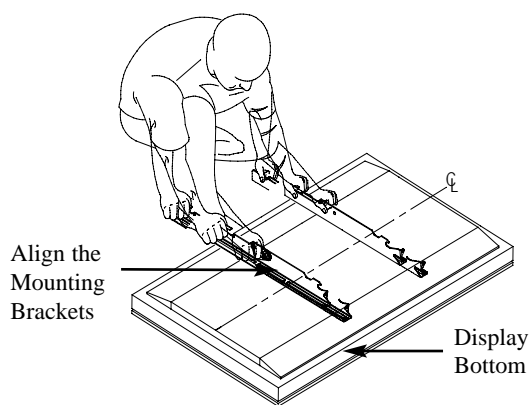

Figure 4

4. Match the center of viewing guide with the center line you marked in step 1 (Figure 4).

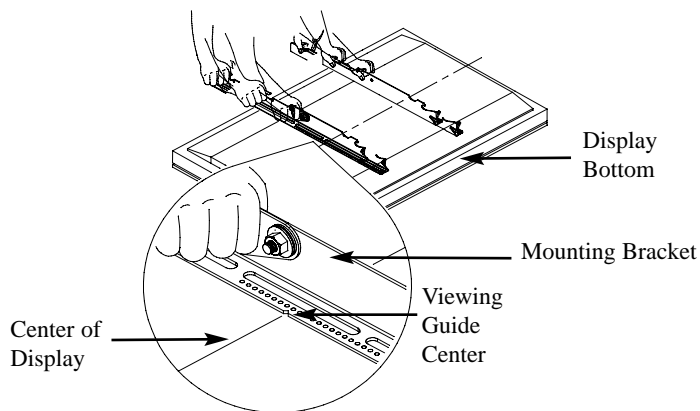

Figure 5

5. The mounting brackets are designed with a center of viewing guide on the side of them (Figure 5).

Securing the Mounting Brackets

The Griplates™ have M4, M5, M6 and M8 hole patterns to fit the hardware that your flat panel requires.

NOTE: Your plasma uses M8 x 20 or M6 x 12 Phillips screws, use the M8, or M6, mounting points.

1. Once the mounting brackets are aligned secure the Griplate™ to the flat panel (Figure 6).

NOTE: The dimples of the top plates have to be facing up and the bottom dimples must be facing down.

2. Pre-install two (2) M6 x 30 (mm) Phillips pan screws to the bottom of the left and right hand side mounting brackets.

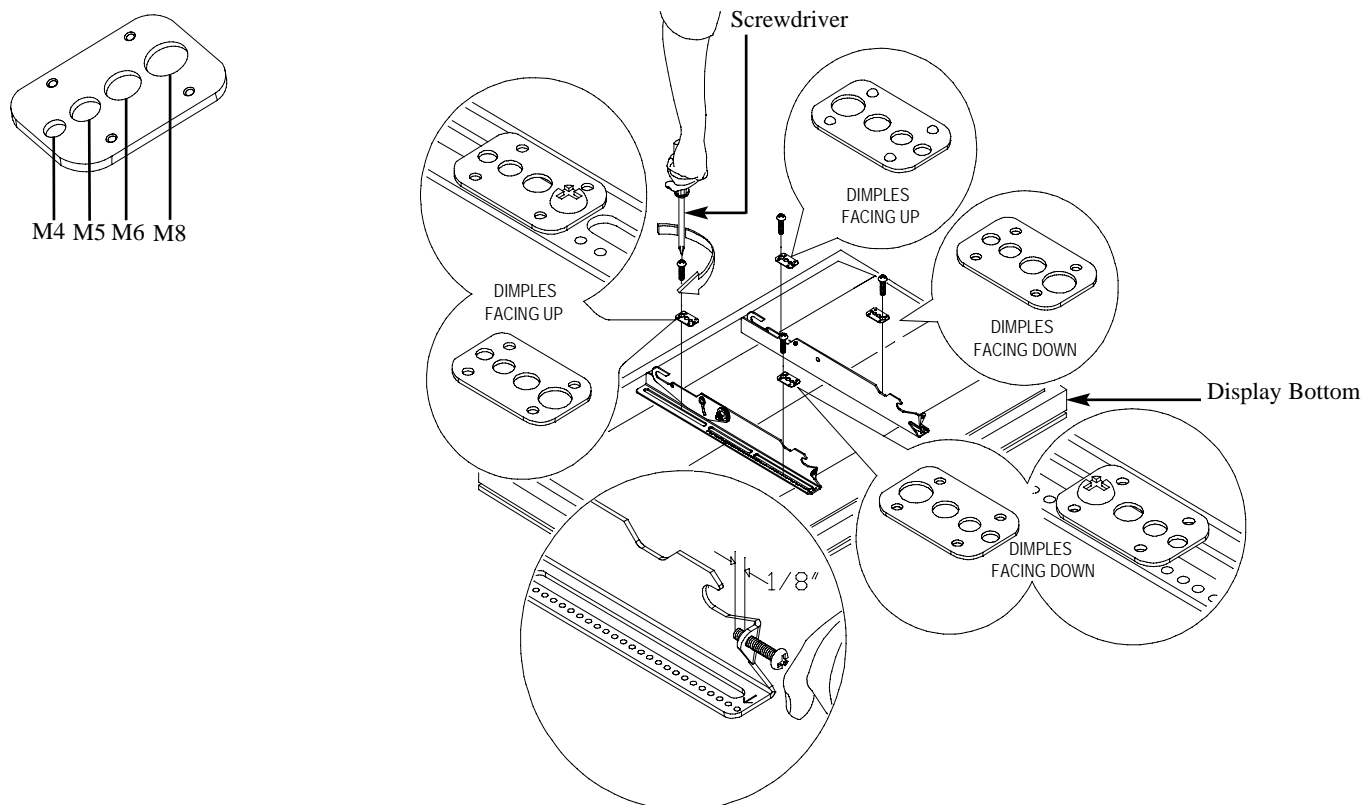

Figure 6

Marking the Wall

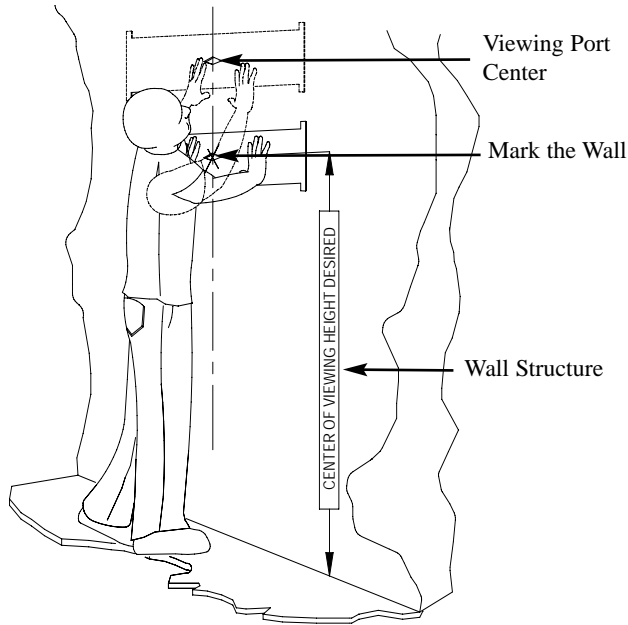

Figure 7

1. Align the center viewing port from the carton template to the wall. Match the center of viewing port to the center of viewing height desired (Figure 7).

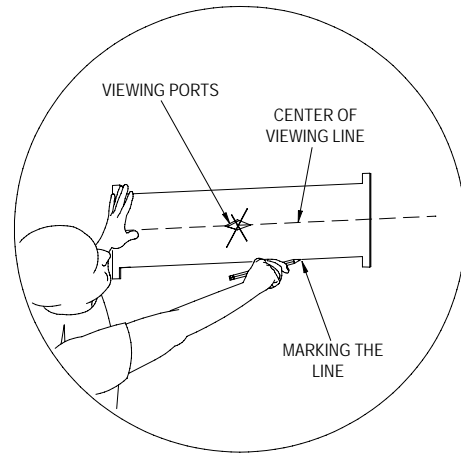

Figure 8

2. Mark a line on the bottom of the carton template (Figure 8).

Marking the Bottom Mounting Points

CAUTION: The lag bolts must be secured to the center of a stud. Use a commercially available stud finder to locate the studs nearest to your center viewing mark.

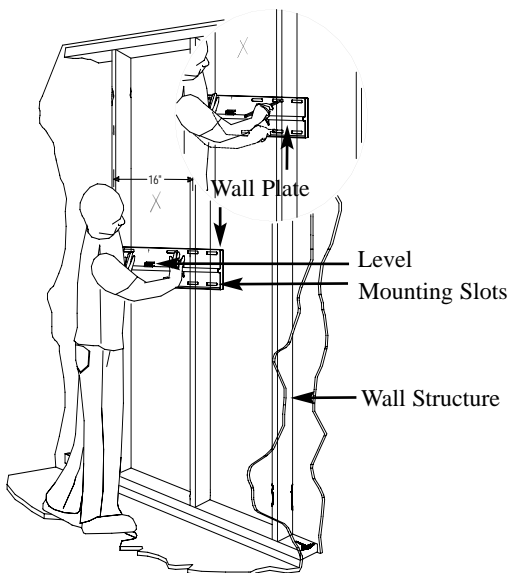

Figure 9

1. Place the upper portion of the bottom wall plate to the reference line and mark the four (4) lag bolt mounting points through the wall plate slots on the wall (Figure 9).
2. Level the wall plate with the reference arrow pointing up to the ceiling.

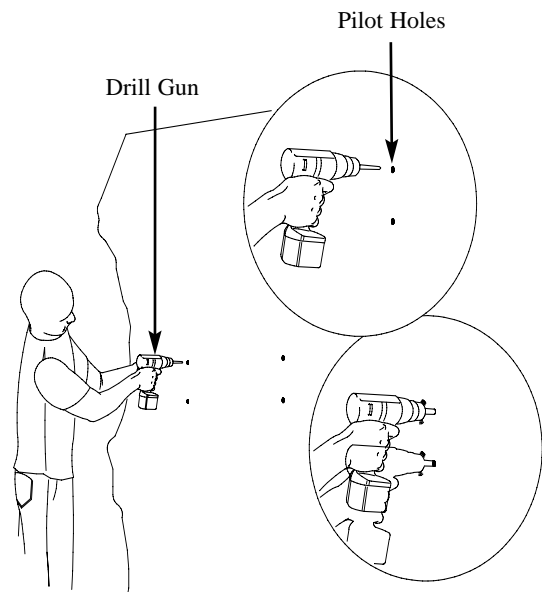

Figure 10

3. Pilot holes are recommended. Use a 1/4" drill bit to drill where your markings are located (Figure 10). These pilot holes will be for the lower mounting plate.

Securing the Lower Wall Plate

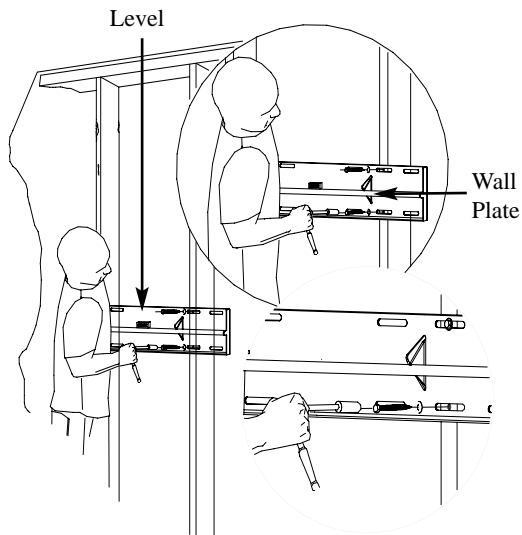

Figure 11

1. Level and secure the plate to the wall with the reference arrow facing up to the ceiling (Figure 11).
2. Secure the plate using the provided lag bolts and washers.

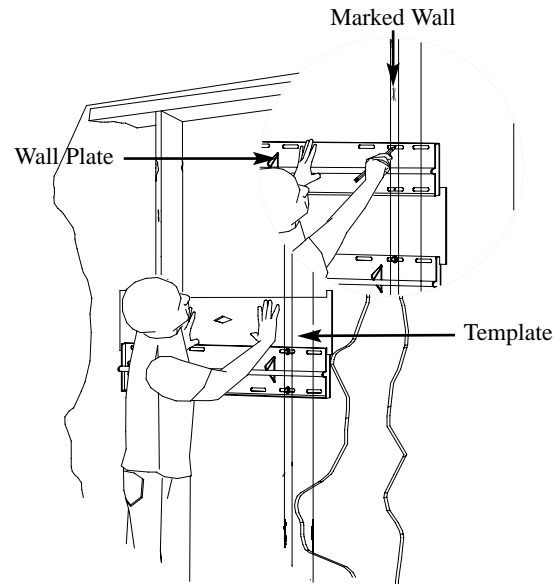

Figure 12

3. When the bottom wall plate is properly installed to the wall.
4. Lay the carton template on top of the wall plate.
5. Lay the top wall plate on top of the cardboard template and mark the four (4) mounting points (Figure 12).

Securing the Upper Wall Plate

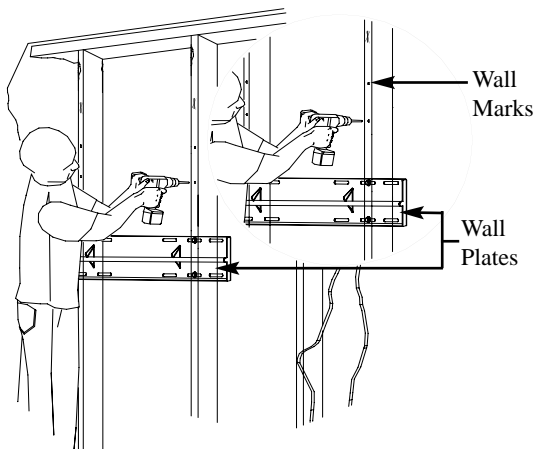

Figure 13

1. Drill four (4) 1/4" pilot holes in the marked wall (Figure 13). These pilot holes will be for the upper mounting bracket.

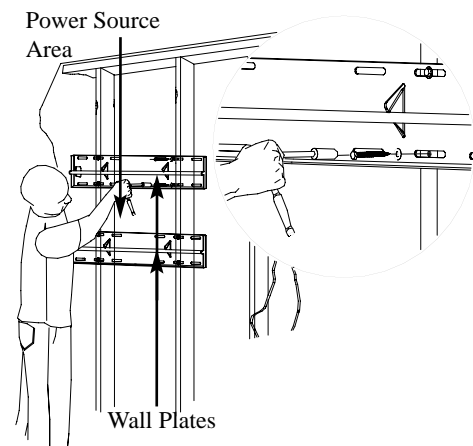

Figure 14

2. Level and secure the plate to the wall with the reference arrow facing up to the ceiling.
3. Secure the plate using the provided lag bolts (Figure 14).

CAUTION: Do not over tighten the mounting hardware.

NOTE: CHECK THE MOUNT FOR PROPER TIGHTNESS AND SECURITY.

Mounting the Display

WARNING: AT LEAST (2) QUALIFIED PERSONNEL ARE STRONGLY RECOMMENDED FOR INSTALLATION OF THIS PRODUCT. FAILURE TO DO SO COULD RESULT IN SERIOUS INJURY AND POSSIBLE DAMAGE TO THE FLAT PANEL.

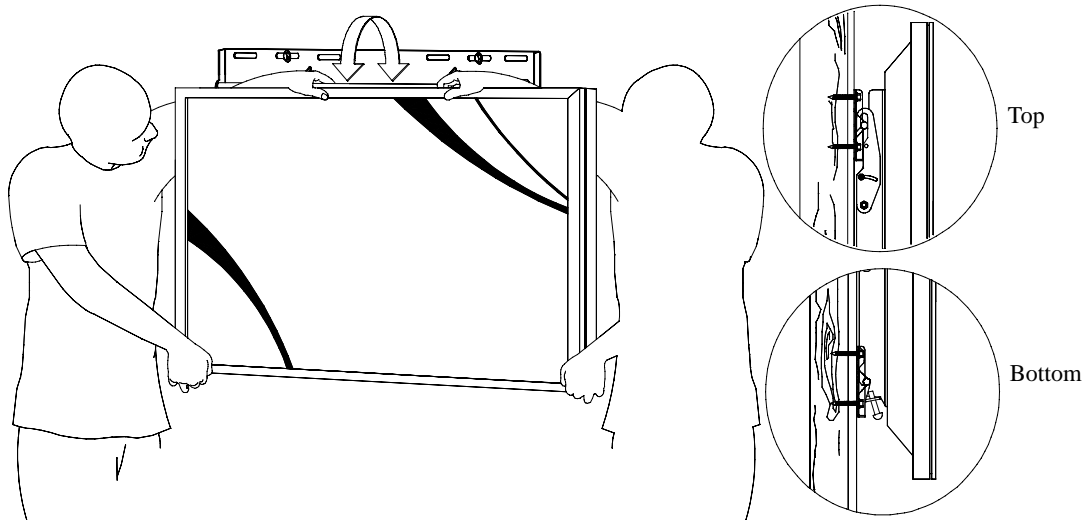

Figure 15

1. Raise the flat panel with the mounting brackets secured to the flat panel and insert the top and bottom hooks from each bracket to the rods from the wall plates (Figure 15).

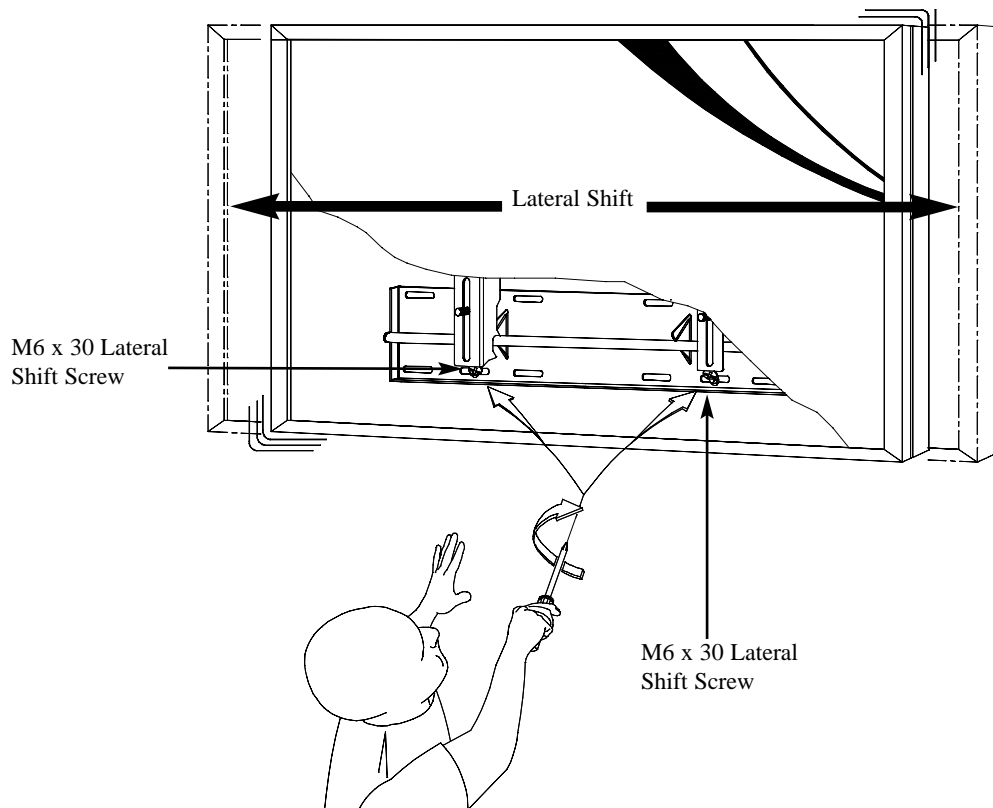

Figure 16

2. Make any lateral shift adjustments and lock the display in place by tightening the two (2) M6 x 30 (mm) Phillips screws found on the bottom of the mounting brackets (Figure 16).

CAUTION: Do not over tighten the M6 screws to the rods.

Securing the Display

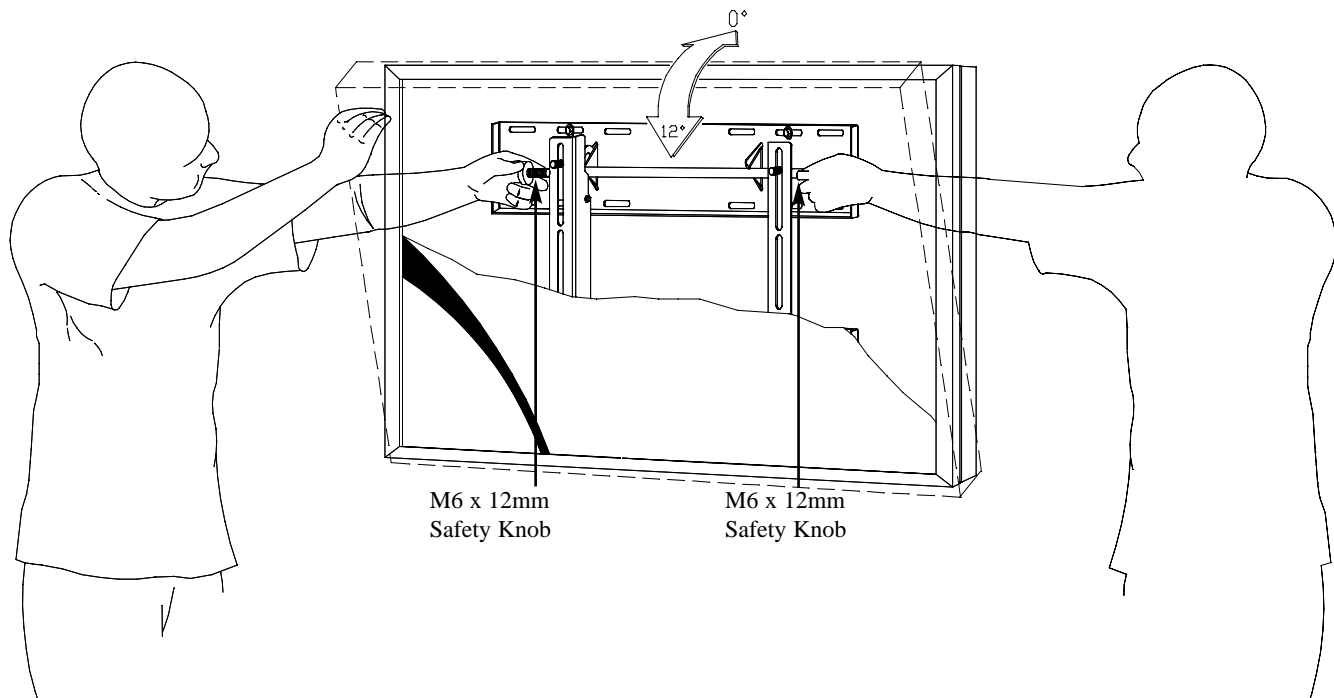

Figure 17

1. Tilt the flat panel and secure the two (2) M6 x 12 mm safety knobs to each of the mounting brackets (Figure 17).

NOTE: To remove the display from the wall simply extend the display to its maximum tilt range, remove the two (2) M6 x 12mm Safety Knobs, push the flat panel back to it's flat position and loosen or remove the two (2) M6 x 30 lateral shift screws and lift the unit of the wall.

Technical Specifications

Dimensions shown in (mm)/inches.

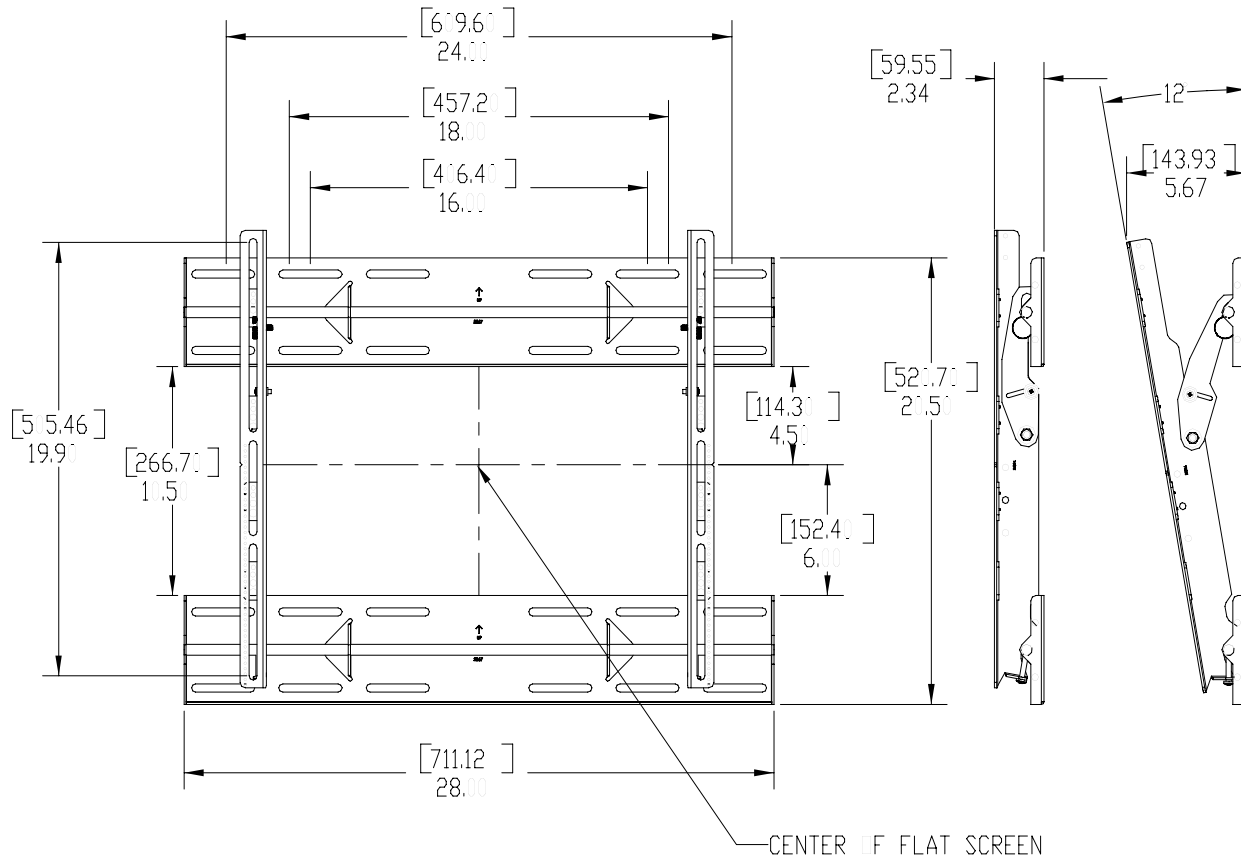

Warranty

Limited Lifetime Warranty

All Premier Mounts products carry a limited lifetime warranty from ship date against defects in materials and workmanship. Premier Mounts is not liable for improper installation that results in damage to mounts, adapters, display equipment or personal injury.

Contact Premier Mounts

In the event of missing and/or damaged equipment, or technical questions, the following information can help in the completion of the installation.

Customer Service - (800) 368-9700 Ext. 224

Technical Support - techsupport@mounts.com

Premier Mounts

3130 E. Miraloma Ave.

Anaheim CA 92806

Phone number: 800-368-9700 Fax: 800832-4888

www.mounts.com mounts@mounts.com