

EPM 3000P

THREE-PHASE DIGITAL VOLT/AMPS MONITOR

EPM 3000P –F

THREE-PHASE VOLTS/AMPS/FREQUENCY MONITOR

Instruction Manual



GE Industrial System

NORTH AMERICA

GE Industrial Systems, 41 Woodford Avenue, Plainville, CT 06062

Internet: <http://www.geindustrial.com>

*All Rights Reserved.
Printed in the United States of America.*

NORTH AMERICA

*GE Industrial Systems, 41 Woodford Avenue, Plainville, CT 06062
Internet: <http://www.geindustrial.com>*

Customer Service and Support

Customer service and support is available 24 hours a day, 7 days a week.

Please have the model, serial number and a detailed problem description available. If the problem concerns a particular reading, please have all meter readings available.

For customer or technical assistance, call: **1-888-GE4SERVICE (1-888-434-7378)**.

Product Warranty

GE warrants all products to be free from defects in material, workmanship and title and will be of the kind and quality specified in GE's written description in the manual. The foregoing shall apply only to failures to meet said warranties which appear within one year from the date of shipping. During the warranty period, GE will, at its option, either repair or replace any product that proves to be defective.

Limitation of Warranty

This warranty does not apply to defects resulting from unauthorized modification, misuse or use for any reason other than electrical power monitoring.

OUR PRODUCTS ARE NOT TO BE USED FOR PRIMARY OVER-CURRENT PROTECTION. ANY PROTECTION FEATURE IN OUR PRODUCTS IS TO BE USED FOR ALARM OR SECONDARY PROTECTION ONLY.

THIS WARRANTY IS IN LIEU OF ALL OTHER WARRANTIES, EXPRESSED OR IMPLIED, INCLUDING ANY IMPLIED WARRANTY OF MERCHANTABILITY OR FITNESS FOR A PARTICULAR PURPOSE. GE SHALL NOT BE LIABLE FOR ANY PENAL, INDIRECT, SPECIAL OR CONSEQUENTIAL DAMAGES ARISING FROM ANY AUTHORIZED OR UNAUTHORIZED USE OF ANY GE PRODUCT. LIABILITY SHALL BE LIMITED TO THE ORIGINAL COST OF THE PRODUCT SOLD.

Statement of Calibration

Our instruments are inspected and tested in accordance with specifications published by an independent testing facility. The accuracy and a calibration of our instruments are traceable to the National Institute of Standards and Technology through equipment that is calibrated at planned intervals by comparison to certified standards.

Disclaimer

The information presented in this publication has been carefully checked for reliability; however, no responsibility is assumed for inaccuracies. The information contained in this document is subject to change without notice.

TABLE OF CONTENTS

INSTALLATION & OPERATION

CHAPTER 1	MECHANICAL INSTALLATION	1
	♦ Installation of the EPM3000P with K-110 Option for limited space conditions	1
	♦ Standard Installation of the EPM3000P	1
	♦ Standard Cutout of EPM3000P	2
	♦ Communication Converter Installation or DC Output	2
CHAPTER 2	ELECTRICAL INSTALLATION	3
Section 2.1	Connecting the Current Circuit	3
2.2	Connecting Voltage Circuit of Potential Transformer	3
2.3	Selecting the Voltage Fuses	3
2.4	Connection to the Main Power Supply	3
2.5	Electrical Connection Installation	4
	♦ 3-Phase, 3-Wire Delta with Direct Voltage and CTs	5
	♦ 3-Phase, 3-Wire Open Delta with 2 CTs and 2 PTs	5
	♦ 3-Phase, 3-Wire Open Delta with 3 CTs and 2 PTs	6
	♦ 3-Phase, 4-Wire Wye with Direct Voltage and CTs	6
	♦ 3-Phase, 4-Wire Wye with CTs and PTs	7
	♦ Single Phase System	7
	♦ Dual Phase System	8
2.6	Relays and Protection	8
CHAPTER 3	COMMUNICATION INSTALLATION	10
Section 3.1	RS-232C	10
3.2	RS-485	10
CHAPTER 4	EPM3000P: OVERVIEW	13
Section 4.1	Accessing Max/Min Values	13
4.2	Resetting Values	14
4.3	Accessing the LM1/LM2 Set Limits	15
4.4	Voltage Phase Reversal and Imbalance	15
4.5	Printing Operating Data	16
4.6	Printing Programming Data	17
4.7	Accessing LED Test	18
4.8	Accessing Firmware Versions	18

TABLE OF CONTENTS

PROGRAMMING

CHAPTER 5	GENERAL PROCEDURE OVERVIEW	19
Section 5.1	How to Use This Portion of the Manual	19
5.2	Switch Packs	19
5.3	Programming Mode Entry	20
5.4	Standard Numeric Data Entry	20
CHAPTER 6	ENTERING THE PROGRAMMING MODE	21
Section 6.1	Checksum Error - Protective Mechanism	21
6.2	Password Entry	21
CHAPTER 7	PROGRAMMING GROUP 0: GLOBAL METER SETUP	22
Section 7.1	The Integration Interval	22
7.2	The Meter Address	23
7.3	Communication Baud Rate	23
7.4	System Configuration	24
7.5	Programming Procedure	26
7.6	Time Delay For Relays 1 & 2	26
CHAPTER 8	PROGRAMMING GROUP 1	29
Section 8.1	Scale Selections & Full Scale Settings	29
8.2	Full Scale Settings, Volt & Amp Channels, Volt & Amp Decimal Placement	29
CHAPTER 9	PROGRAMMING GROUP 2: METER CALIBRATION	31
Section 9.1	Standard Calibration	31
9.2	High End Calibration of Voltage Channels, High & Low End Calibration of Amperage Channels	32
CHAPTER 10	PROGRAMMING GROUP 4: SET LIMITS & RELAYS	34
Section 10.1	Trip Relay	34
CHAPTER 11	PROGRAMMING GROUP 7: PHASE REVERSAL & PHASE IMBALANCE SET LIMITS/RELAYS	38
Section 11.1	Voltage Phase Reversal & Phase Imbalance	38
11.2	Trip Relay	38
11.3	Voltage Phase Reversal Detection	39
11.4	Percentage Voltage Phase Imbalance	40
CHAPTER 12	EXITING THE PROGRAMMING MODE	41

INSTALLATION & OPERATION

CHAPTER 1

MECHANICAL INSTALLATION

The following diagrams display the various possible EPM3000P and EPM3000P-F mechanical installations and Communication Converter installation. All illustrations are of the EPM3000P with notes on the F Model.

NOTE: ALL MEASUREMENTS ARE IN INCHES.

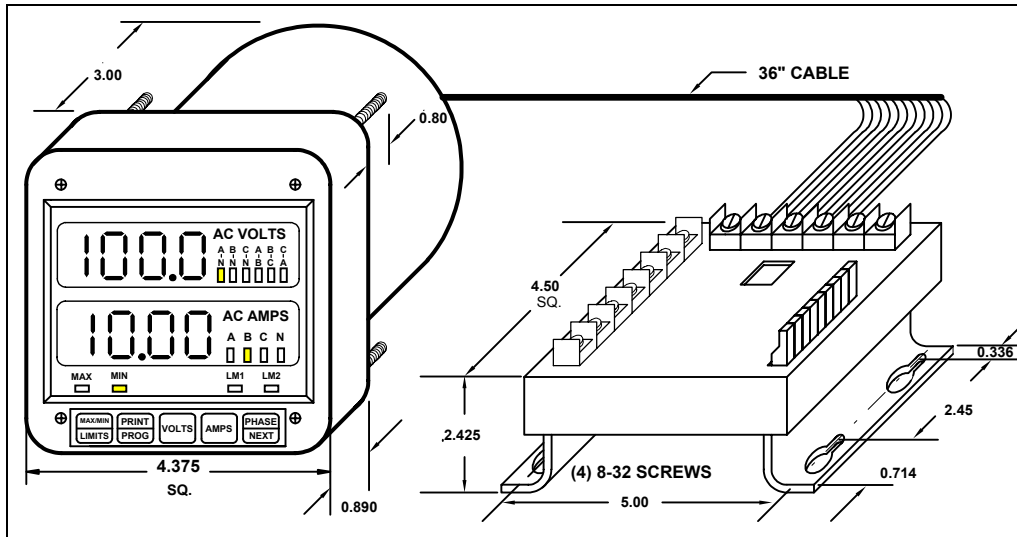

Diagram 1.1 Installation of the EPM3000P with K-110 Option for limited space conditions.

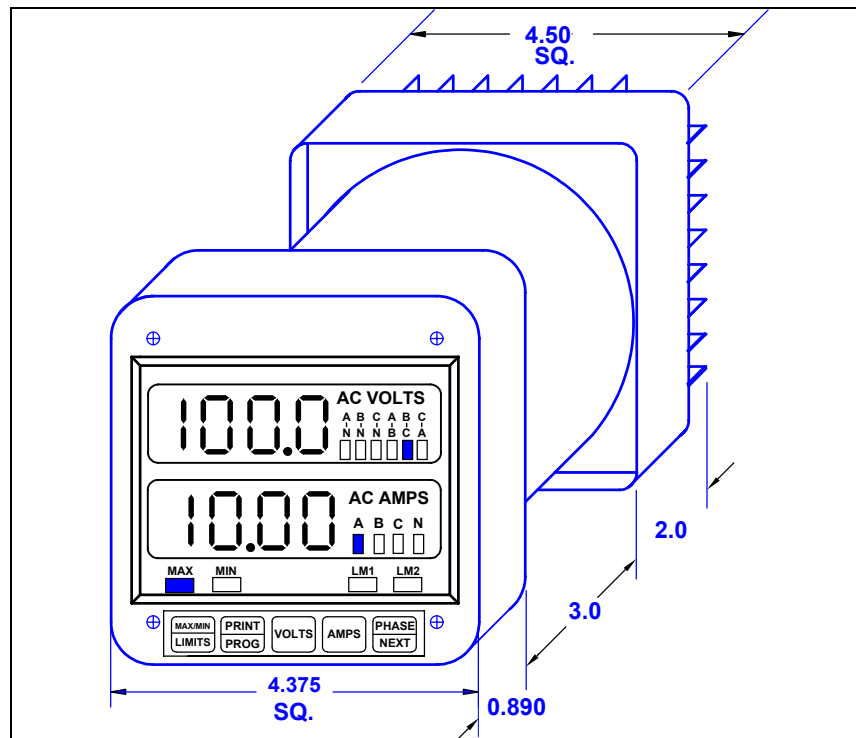

Diagram 1.2 Standard Installation of the EPM3000P.

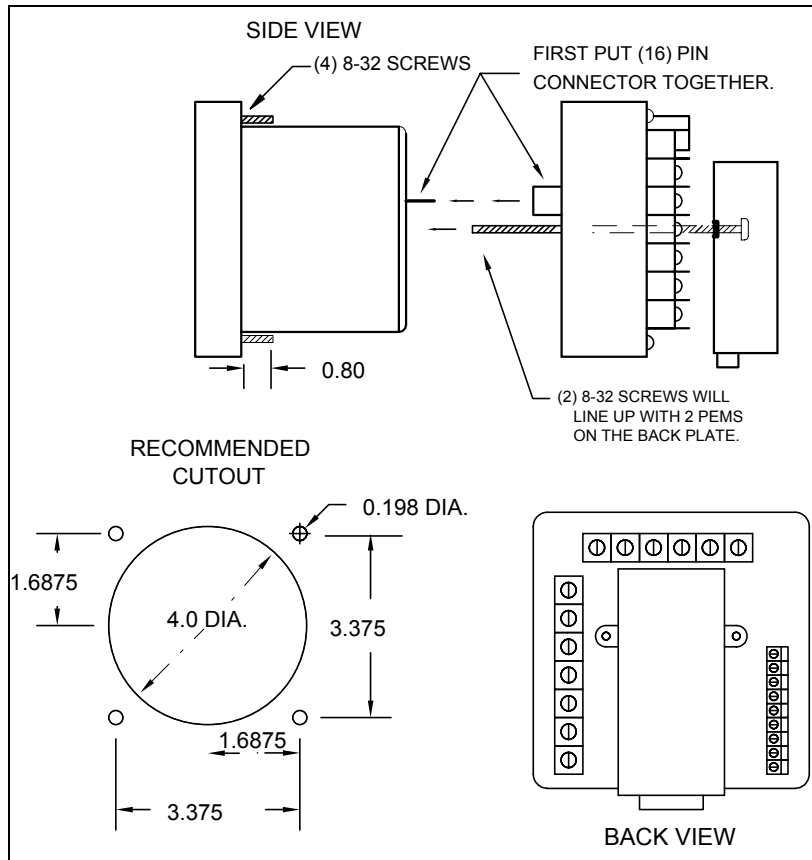

Diagram 1.3 Standard cutout for EPM3000P.

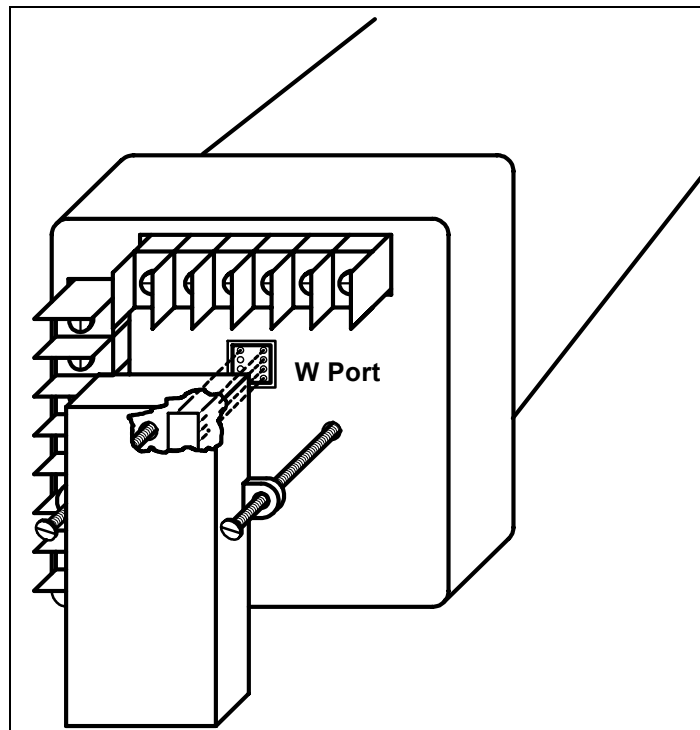

Diagram 1.4 Optional Communication Converter or DC Output Module Installation

NOTE: CAREFULLY LINE UP THE GUIDE SCREW AND 8 PIN PORT CONNECTOR TO PREVENT PINS FROM BREAKING.

CHAPTER 2

ELECTRICAL INSTALLATION

2.1 CONNECTING THE CURRENT CIRCUIT

The cable used for the current should be installed at 600V AC minimum. The cable connector should be rated at 6 Amps or greater, and it should have a cross-sectional area of 16 AWG.

The current transformers should be mounted as close as possible to the meter. The following table gives the maximum recommended distances for various CT sizes, assuming the connection is made via 16 AWG cable.

CT SIZE (VA)	MAXIMUM DISTANCE (CT TO EPM3000P)
2.5 VA	10 FEET
5.0 VA	15 FEET
7.5 VA	30 FEET
10.0 VA	40 FEET
15.0 VA	60 FEET
30.0 VA	120 FEET

WARNING: DO NOT LEAVE SECONDARY OF CT WHEN PRIMARY CURRENT IS FLOWING. THIS MAY CAUSE HIGH VOLTAGE, WHICH OVERHEATS THE SECONDARY OF THE CT. IF THE CT IS NOT CONNECTED, PROVIDE A SHORTING BLOCK ON THE SECONDARY OF THE CT.

2.2 CONNECTING VOLTAGE CIRCUIT OF POTENTIAL TRANSFORMER

For proper operation, the voltage connection *must* be maintained. If an error occurs, such as mistaking Line A for Line B, a PH message appears, indicating a Phase Reversal (see Phase Imbalance and Reversal).

The cable required to terminate the voltage sense circuit should have an insulation rating greater than 600V AC and a current rating greater than 0.1 A.

2.3 SELECTING THE VOLTAGE FUSES

We recommend using fuses, although connection diagrams do not show them. Slow blow, 200 mA rating fuses should be used.

The maximum voltage EPM3000P can handle 150V phase to neutral. If Suffix -G is added to the model number, the maximum voltage to be used is 300V phase to neutral.

2.4 CONNECTION TO THE MAIN POWER SUPPLY

The EPM3000P requires a separate power supply connection. Listed are the 5 different power supply options and corresponding.

NOTE: FOR DC-POWERED UNITS POLARITY MUST BE OBSERVED. AN EARTH TO GROUND CONNECTION TO CHASSIS IS MANDATORY FOR NORMAL OPERATION (TERMINAL 3). DO NOT GROUND THE UNIT THROUGH THE NEGATIVE OF THE DC SUPPLY. SEPARATE GROUNDING IS REQUIRED.

POWER SUPPLY OPTIONS	SUFFIXES	CURRENT
120V AC	NO SUFFIX	.1 AAC
240V AC	A	.05 AAC
24V DC	D	.5 ADC
48V DC	D1	.25 ADC
125V DC	D2	.1 ADC

2.5 ELECTRICAL CONNECTION INSTALLATION

Choose the diagram that best suits your application and maintain the polarity. Follow the outlined procedure to verify correct connection.

NOTE: THE NEUTRAL READING IS CALCULATED FROM THE SUM OF THE 3 PHASES OF CURRENT. HIGH NEUTRAL CURRENT INDICATES REVERSE CT POLARITY.

LISTING OF CONNECTION DIAGRAMS

NOTE: SEE PHASE REVERSAL IF A MESSAGE OF PH APPEARS AFTER INSTALLATION.

- I Three-Phase, Three-Wire System Delta with Direct Voltage and CTs.
- II Three-Phase, Three-Wire Open Delta with two CTs and two PTs.
(Open Delta System Installation should only be used if the electrical system is a 3-wire OPEN DELTA. Open Delta can be enabled or disabled in Programming Group 0, Function 3.)
- III Three-Phase, Three-Wire Open Delta with three CTs and two PTs.
(Open Delta System Installation should only be used if the electrical system is a 3-wire OPEN DELTA. Open Delta can be enabled or disabled in Programming Group 0, Function 3.)
- IV Three-Phase, Four-Wire System Wye with Direct Voltage and CTs.
- V Three-Phase, Four-Wire System Wye with CTs and PTs.
- VI Single Phase System
- VII Dual Phase System

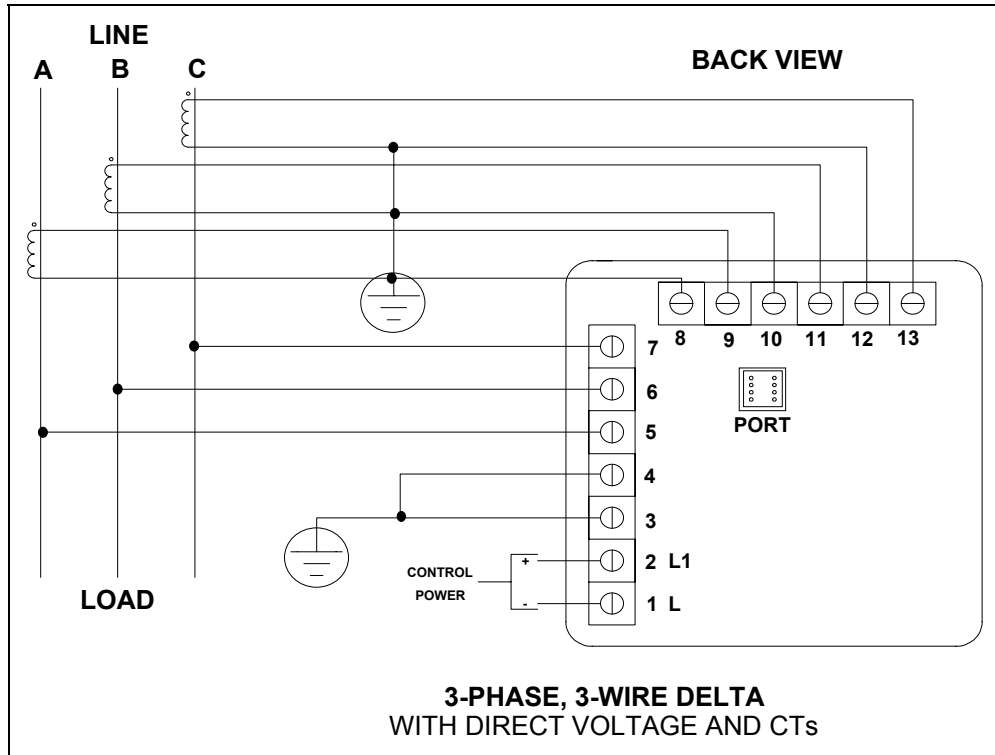

I. Three Phase System

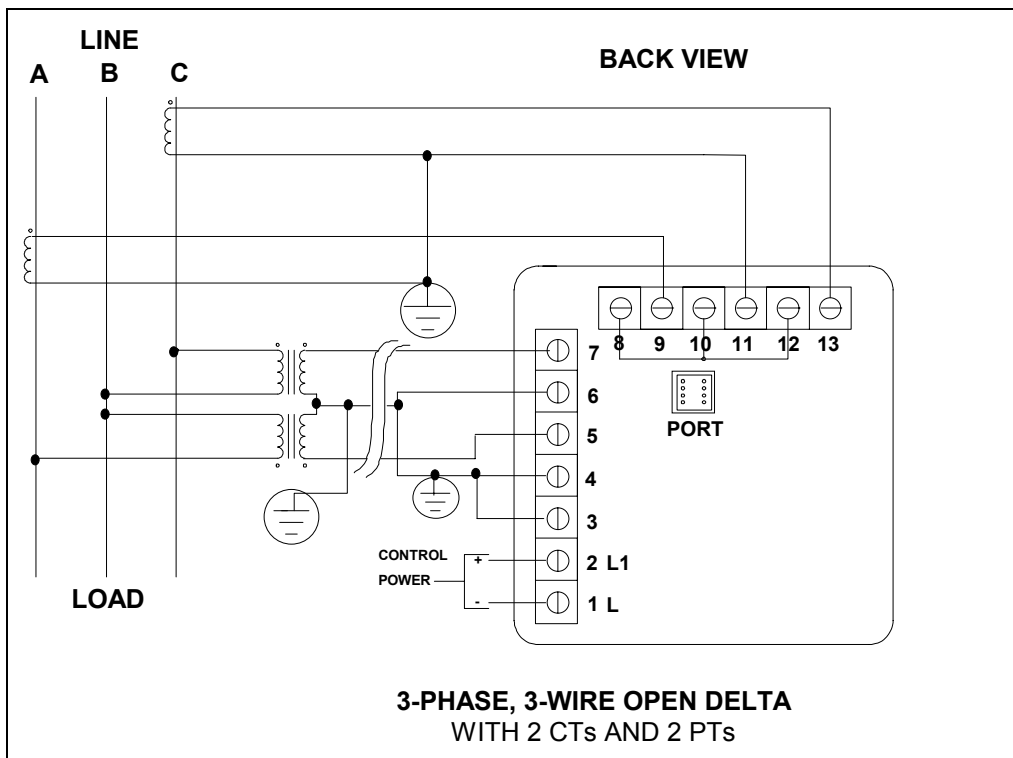

II. Open Delta PT Connection

Special programming required.

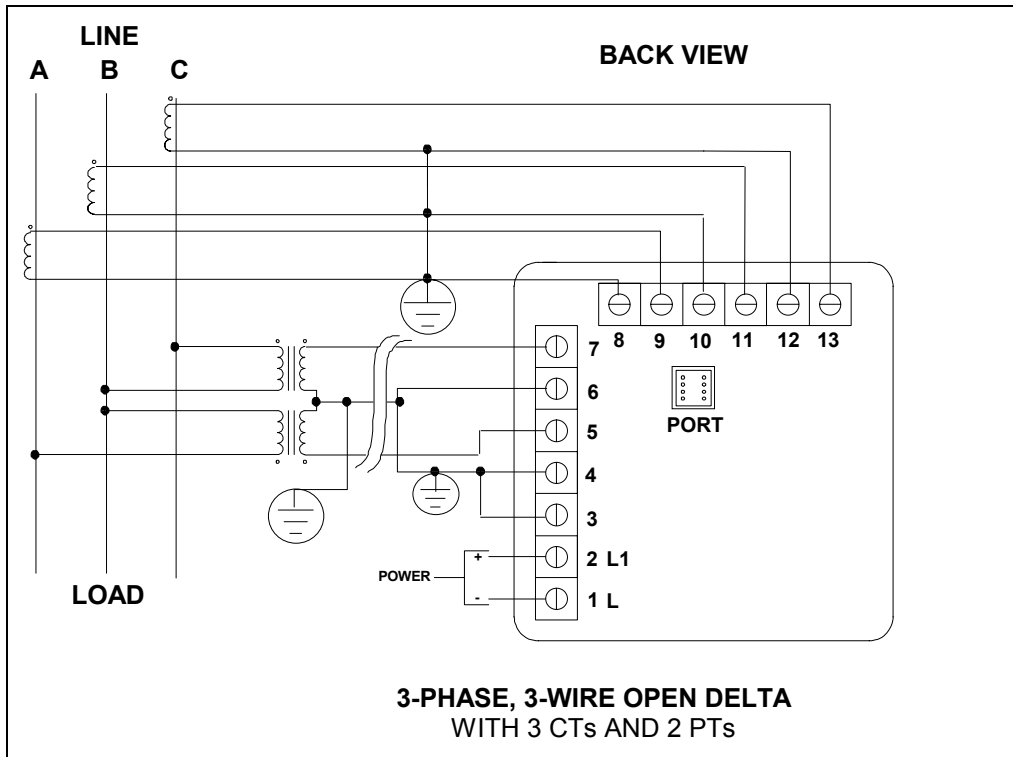

III. Open Delta PT Connection

Special programming required.

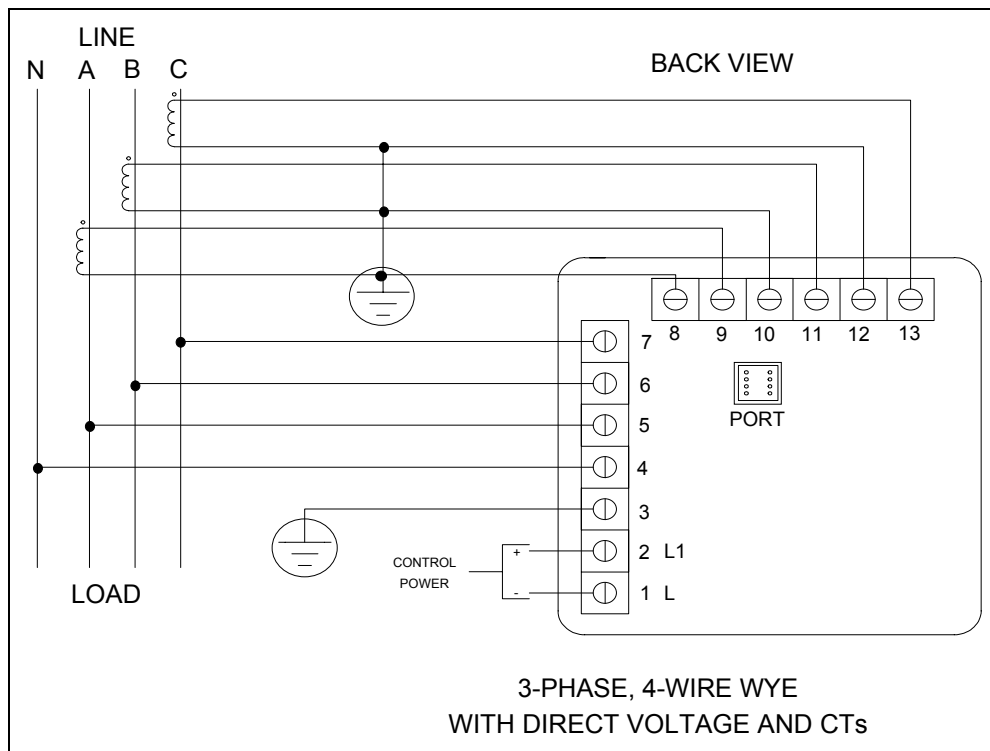

IV. Three Phase System

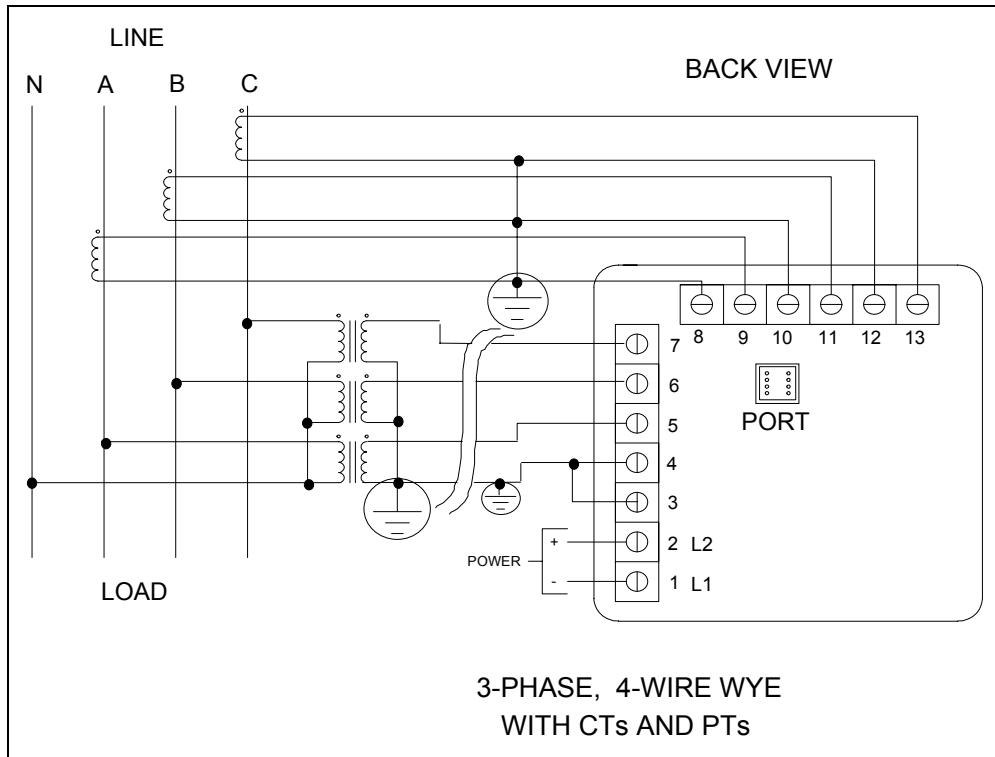

V. Three Phase System Wye System with PTs

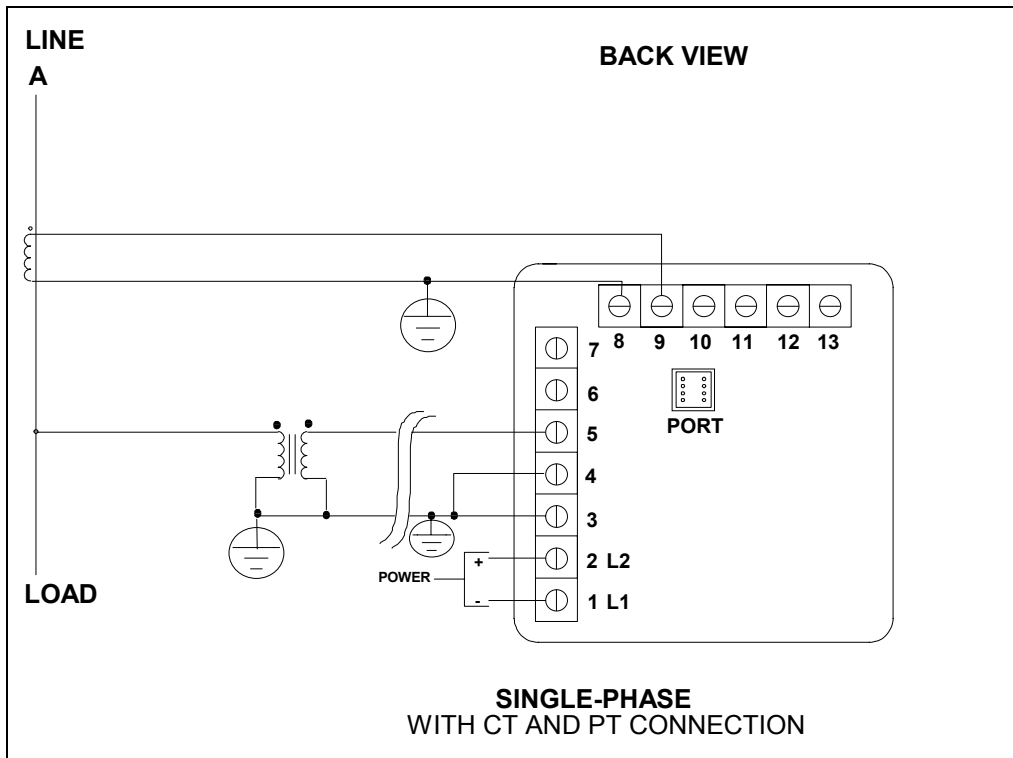

VI. Single-Phase System

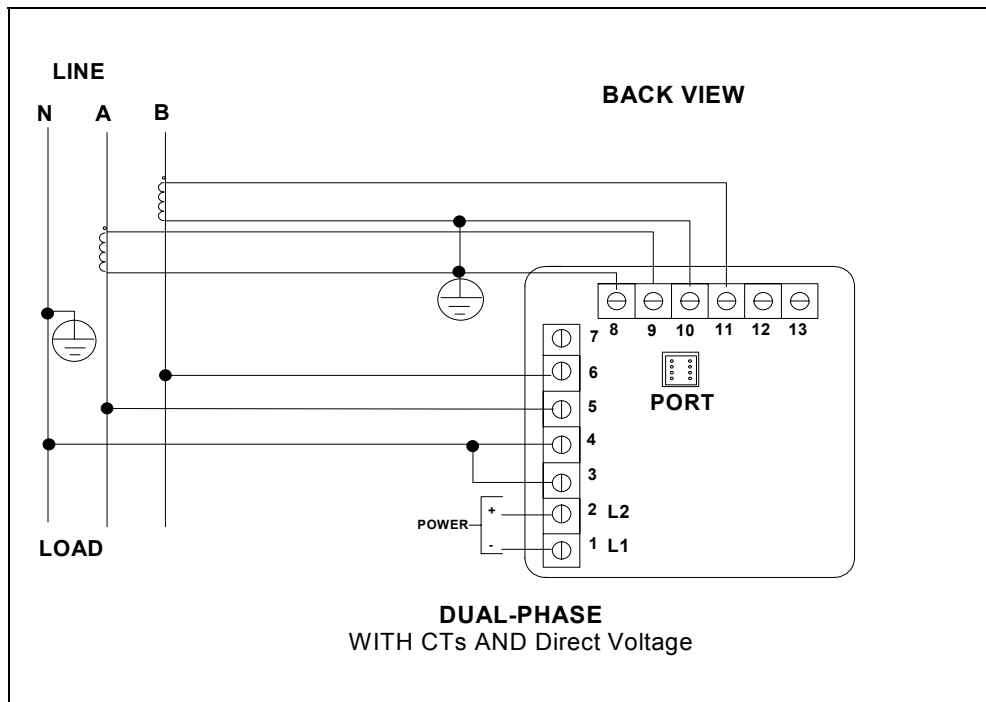

VII. Dual-Phase System

2.6 RELAYS AND PROTECTION

NOTE: THIS SECTION IS APPLICABLE ONLY IF THE -NL RELAY OPTION WAS ORDERED.

The EPM3000P allows the user to access a variety of relay options through the programming mode. The relay option package consists of two relays, which can be dedicated to alarm or communication (or both).

TIME DELAY: Sets off the alarm, alerting the user that an out-of-limits condition occurred during the defined time limit. The time delay can be programmed for any desirable duration.

If the relays are dedicated to communication, there are two different modes:

- Lock ON Relay will not be affected by any alarm condition.
- Lock OFF Relay will not be affected by any alarm condition.

If the relays are used for communication and alarm, there are four different modes:

- Lock ON Relay stays on regardless of any alarm condition.
- Lock OFF Relay stays off regardless of any alarm condition.
- Free ON Relay turns on unless other conditions force it off.
- Free OFF Relay turns off unless other conditions force it on.

Figure 2.1 - Relay Connection

Close-up of the relays on the rear panel. The relays shown are in the NOT energized state. (Form C relays, rated 250V, 5A, 2 each)

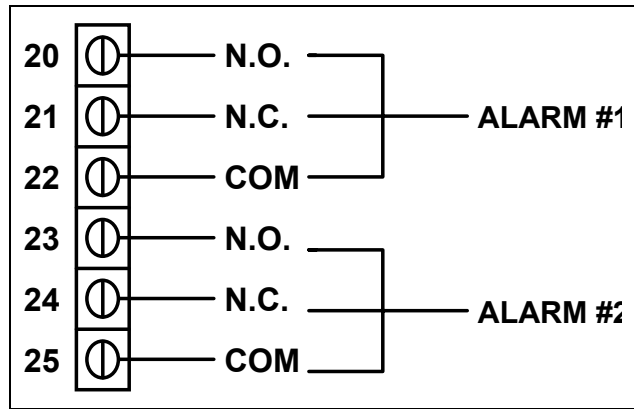

THE INSTRUMENT CAN BE PROGRAMMED TO DETECT TWO ALARM LEVELS FOR THE FOLLOWING FUNCTIONS:

- LM1/LM2 Voltage AN, BN, CN, AB, BC, CA
- LM1/LM2 Current A, B, C, N
- Voltage Imbalance (One level only)
- Voltage Phase Reversals (One level only)

CHAPTER 3

COMMUNICATION INSTALLATION

3.1 RS-232C

All EPM3000P and EPM300P-F instruments can be equipped with: the EIA RS-232C or the EIA RS-485.

RS-232C communication links a single instrument with a computer or device such as an RTU or PLC. Its capability is up to 100 feet. A standard 9-pin female serial port connector mounts on the instrument for direct connection to a computer with a 9-pin cable.

NOTE: ONLY THREE PINS ARE USED IN RS-232C. (See **Figure 3.1**).

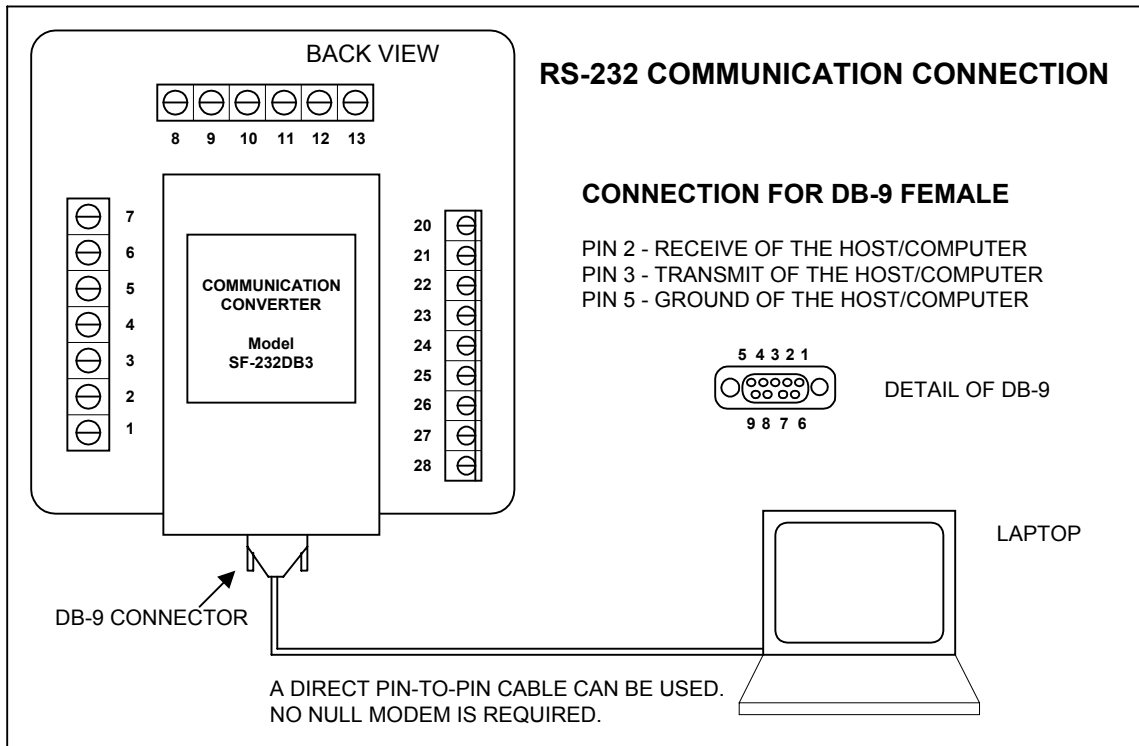

Figure 3.1 RS-232C Communication Connection Installation

NOTE: TO AVOID GROUND LOOPS, THE NEUTRAL AND SAFETY GROUND (PIN 3) SHOULD BE CONNECTED TOGETHER AT ONLY ONE POINT.

3.2 RS-485

NOTE: THIS SECTION APPLIES ONLY IF A COMMUNICATION OPTION WAS ORDERED.

Each EPM3000P has a unique address up to four digits long. This allows the user to communicate with up to 10,000 instruments. Standard baud rates are available up to 4800 baud. To select the proper baud rate, apply the following rules:

The unit operates up to 4800. For a smaller number of instruments over a long distance, use a lower baud. Optimal recommended baud rate is 1200 baud if noisy conditions exist.

RS-485 is used to parallel multiple instruments on the same link. Its operating capability is up to 4000 feet.

- When only 2 wires are used (on the RS-485), the link can include up to 30 instruments, (Figure 3.2).
- When using all 4 wires, the link can include up to 60 instruments, (Figure 3.3).

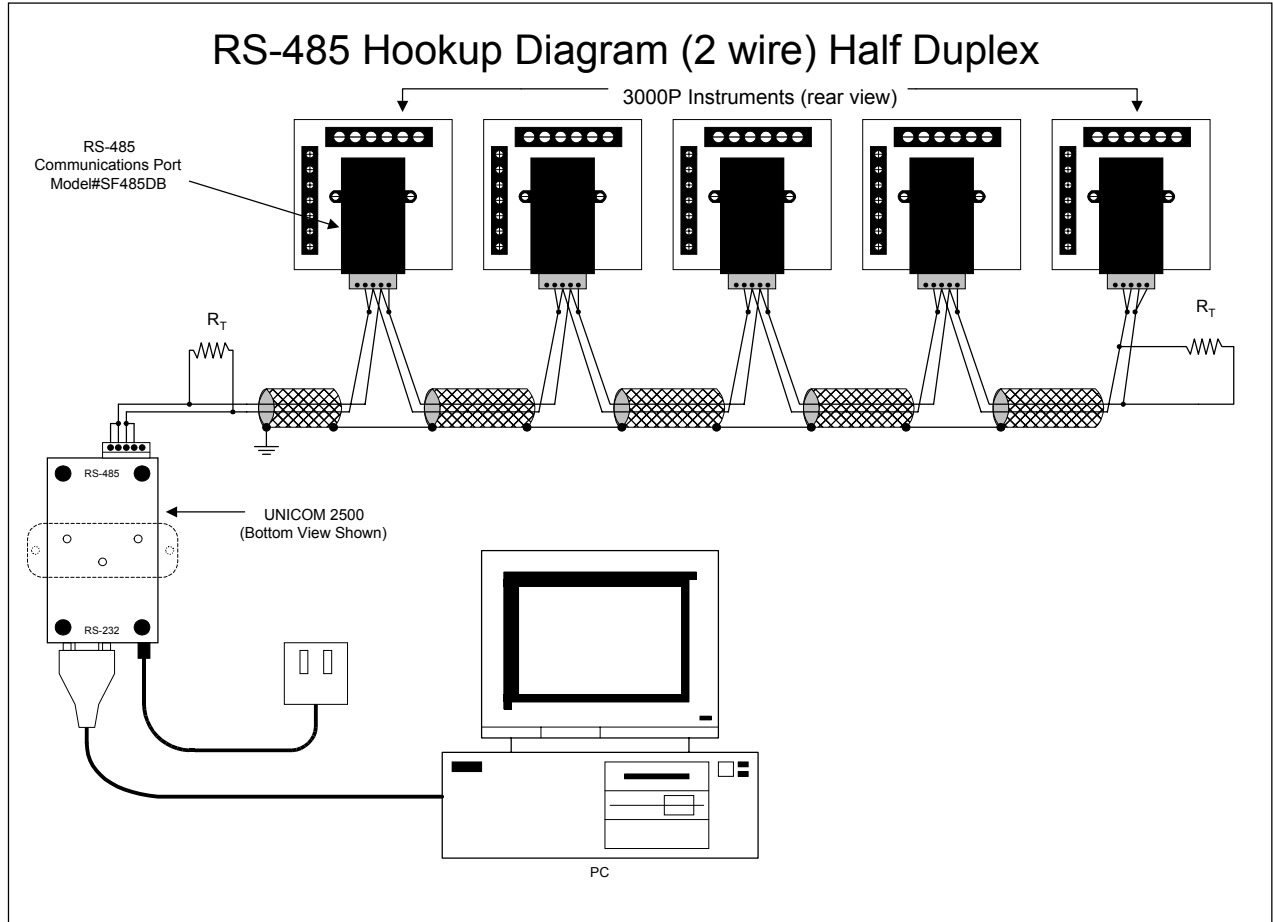

Figure 3.2 2-Wire RS-485 Communication Connection Installation Half Duplex

NOTE: Communication is supported over Belden 3074F and Belden 9841 cable types.

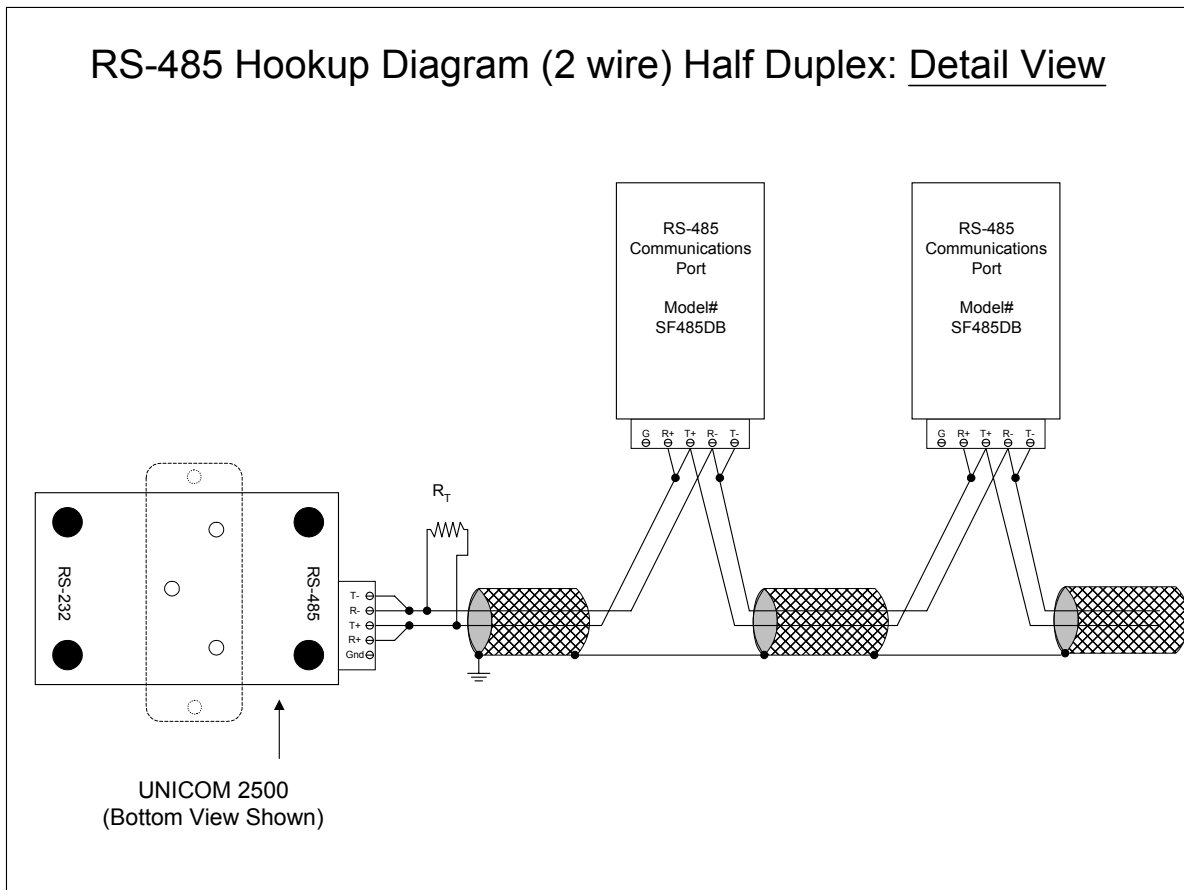

Figure 3.3 2-Wire RS-485 Communication Connection Installation Half Duplex Detailed View

NOTE: Communication is supported over Belden 3074F and Belden 9841 cable types.

CHAPTER 4

EPM3000P OVERVIEW

The EPM3000P and EPM3000P-F measure 10 electrical parameters. Values for each parameter are accessed through the keypad on the meter's front panel (See **Figure 4.1**). The meters illustrated throughout the manual are EPM3000P except for Figure 4.1 below. The EPM3000P-F (Frequency Option) displays the Frequency measurement on the face of the meter. Max, Min and Limits indicators are on the left side of the face.

VOLTS	AMPS
A-N	A
B-N	B
C-N	C
A-B	N
B-C	
C-A	

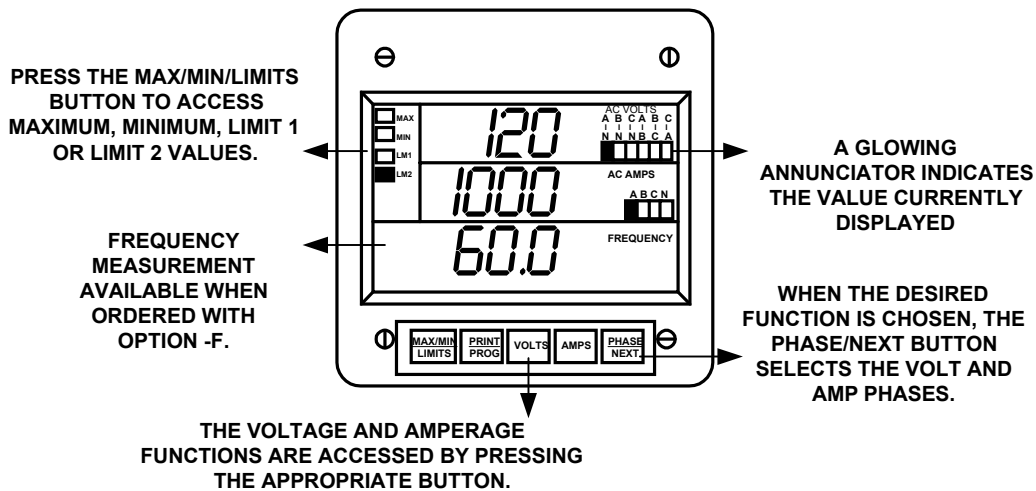
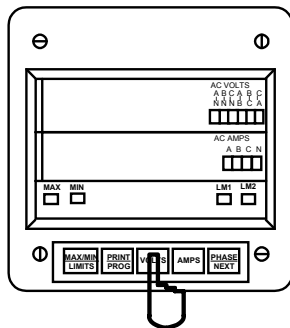

Figure 4.1 : EPM3000P –F (FREQUENCY OPTION)

4.1 ACCESSING MAX/MIN VALUES FROM OPERATING MODE

The max/min values represent the highest and lowest average demand over a user programmable time period, known as the **INTEGRATION INTERVAL**. The readings are calculated using a rolling average technique. Each second, a new reading is used to calculate the max/min and the last reading of the interval is dropped.

⇒ To **ACCESS MAX/MIN VALUES**, follow these steps:



Step 1:
a. Press **VOLTS** to select the VOLTS category.

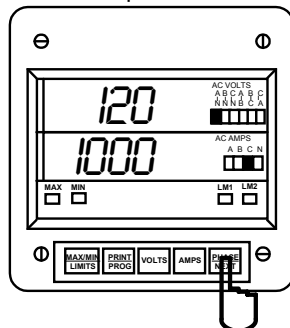

Step 2:
a. Press **PHASE/ NEXT** until the desired phase is selected.

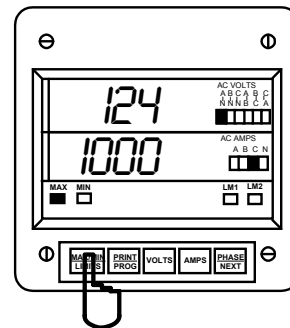

Step 3:
a. Press **MAX/MIN/ LIMITS**:
⇒ ONCE for max of VOLT A-N
⇒ TWICE for min of VOLTS A-N

4.2 RESETTING VALUES FROM OPERATING MODE

Use the reset function if a new value is desired. It is available in two different modes:

1. **UNPROTECTED MODE:** allows quick and easy resetting of max/min values.
2. **PROTECTED MODE:** prevents unauthorized personnel from resetting the max/min.

□ UNPROTECTED RESET

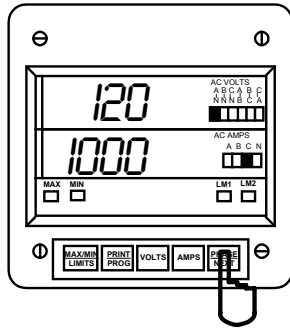

Step 1:
a. Press **PHASE/NEXT** to select the desired phase.

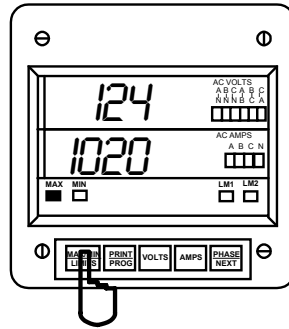

Step 2:
a. Press **MAX/MIN/LIMITS:**
⇒ ONCE for max
⇒ TWICE for min

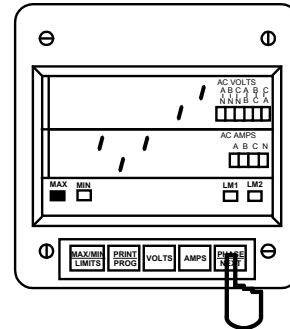

Step 3:
a. Press **PHASE/NEXT** to reset.
⇒ The display blanks and a checkmark appears, confirming successful reset.

□ PROTECTED RESET

NOTE: If the meter was programmed to have a protected reset, a password must be entered before any readings may be reset. The password is **005**.

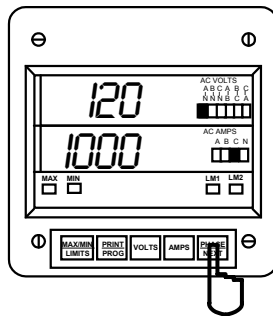

Step 1:
a. Press **PHASE/NEXT** to select the desired phase.

b. Press **MAX/MIN/LIMITS:**
⇒ ONCE for max
⇒ TWICE for min

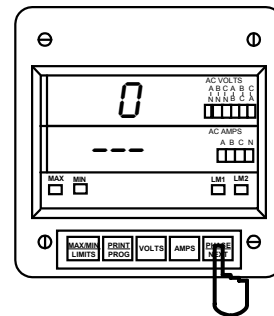

Step 2:
a. Press **PHASE/NEXT** to commence the Protected reset.
⇒ The display blanks, three dashes appear in lower display and digits begin scrolling in upper display.
⇒ The password required is **005**.

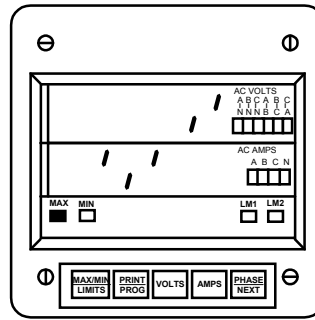
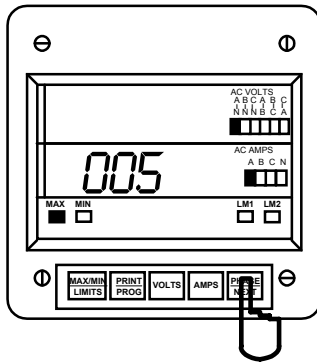

Step 3:
 a. Press **PHASE/NEXT** each time the appropriate password number appears.

Step 4:
 ⇒ Upon entering the correct password, the display blanks and a checkmark appears, confirming successful reset.

4.3 ACCESSING THE LM1/LM2 SET LIMITS FROM OPERATING MODE

The DMVA100 is designed with two manual set limits. The set limits monitor the instantaneous readings, warning the user of abnormal conditions. Each limit can detect readings above or below the set level. **SET LIMITS:** the point when the relay changes position, if the DMVA100 is equipped with the Relay Option (Suffix -NL).

If a limit is exceeded, the annunciator LM1 and/or LM2 indicator glow and the display flashes, alternating between the instantaneous reading.

⇒ To **VIEW THE SETUP OF THE LM1/LM2 SET LIMITS OF THE FUNCTIONS**, follow these steps:

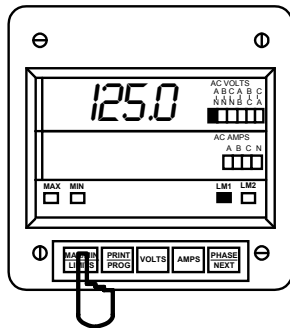

Step 1:
 a. To access the set limit, press **MAX/MIN/ LIMITS:**

⇒ THREE times for LM1
 ⇒ FOUR times for LM2

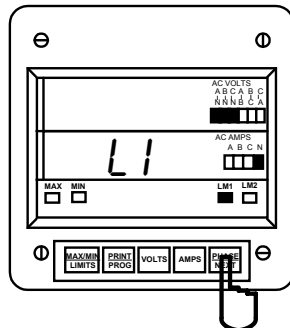

Step 2:
 a. Press **PHASE/NEXT** when the LM1 annunciator glows.

⇒ The annunciators that glow are out-of-limits in LM1.

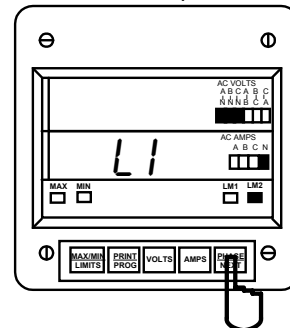

Step 3:
 a. Press **PHASE/NEXT** when the LM2 annunciator glows.

⇒ The annunciators that glow are out-of-limits in LM2.

4.4 VOLTAGE PHASE REVERSAL AND IMBALANCE FROM OPERATING MODE

In a three phase power distribution system, the normal phase shift between each line is 120°. The EPM3000P detects an abnormality and displays a PH message every six seconds.

VOLTAGE PHASE REVERSAL:

If there is an incorrect connection, such as mistaking line A for line B, a PH message appears. The correct sequence is a-b-c.

VOLTAGE PHASE IMBALANCE LIMIT:

Can be detected using the phase imbalance limit in the Programming Mode. The phase imbalance is expressed in a percentage with 0% indicating a 120° phase shift between each line. A PH message appears if the limit is exceeded.

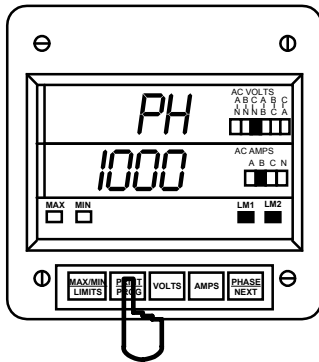

Step 1:
a. Press **AMPS** and **PHASE/NEXT** simultaneously to access the display.

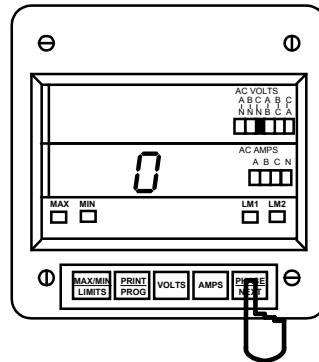

Step 2:
a. Press **PHASE/NEXT** to select zero.

NOTE: PH INDICATES BOTH VOLTAGE PHASE REVERSALS AND VOLTAGE PHASE IMBALANCES.

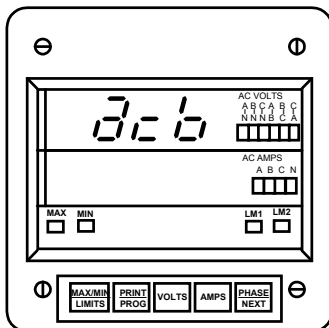

⇒ Upper display indicates a Voltage Phase Reversal of B and C.

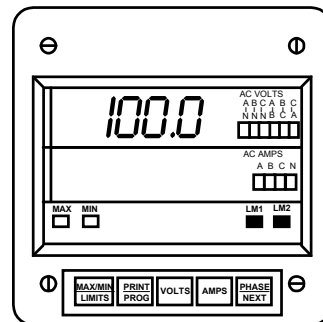

⇒ Upper display indicates a Voltage Phase Imbalance. Limit has been exceeded.

In the event Voltage Phase Reversal and Voltage Phase Imbalance occur simultaneously, the display alternates between the incorrect phase sequence and the exceeded limit percentage. After six seconds the display returns to the normal operating mode.

ACCESS MODE

Sections 4.6, 4.7 and 4.8 allow the user to access specific operation tasks (see table below).

ACCESS	OPERATION
1	Print Operating Data
2	Print Programming Data
3	Enter Programming Mode (see Programming Manual)
4	LED Test

NOTE: PRINT COMMANDS 1 AND 2 ARE ONLY AVAILABLE IF ENABLED IN THE PROGRAMMING MODE AND ARE NOT RECOMMENDED WHEN USING THE MULTIMETER CONNECTION RS485.

4.5 PRINTING OPERATING DATA FROM OPERATING MODE

NOTE: THIS FUNCTION APPLIES ONLY IF A SERIAL PRINTER IS CONNECTED TO THE DMVA 100 VIA AN RS232C COMMUNICATION CONVERTER.

This function sends the data to a serial printer. This allows hard copy of the instantaneous and max/min data of all the functions to compile without manually copying the data.

⇒ To **PRINT THE OPERATING DATA**, follow these steps:

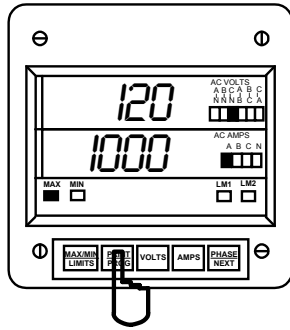

Step 1:
a. Press **PRINT/PROG** to begin the special printing sequence.

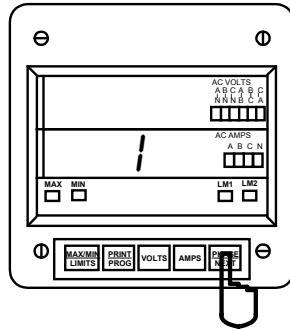

Step 2:
a. The display blanks and **1** appears.
b. Press **PHASE/NEXT** to select.

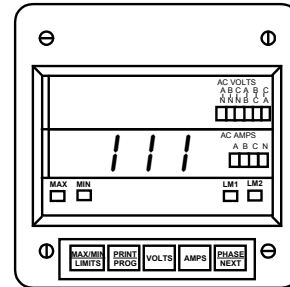

⇒ **111** appears confirming a successful print command.

4.6 PRINTING PROGRAMMING DATA FROM OPERATING MODE

NOTE: THIS FUNCTION APPLIES ONLY IF A SERIAL PRINTER IS CONNECTED TO THE EPM3000P VIA AN RS232C COMMUNICATION CONVERTER.

This function sends the programming data (or the meter setup) to a serial printer for verification and quick reference.

⇒ To **PRINT THE PROGRAMMING DATA**, follow these steps:

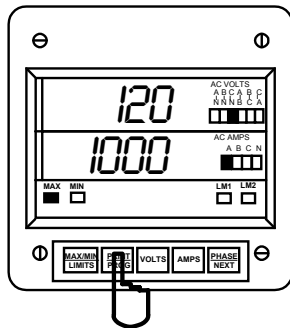

Step 1:
a. Press **PRINT/PROG** to enter the access mode.

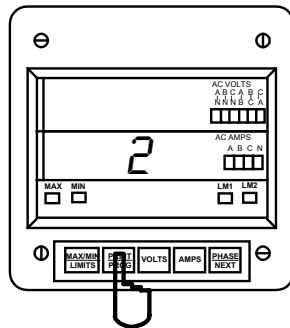

Step 2:
⇒ The display blanks.
a. Press **PRINT/PROG** until **2** appears.
b. Press **PHASE/NEXT** to select.

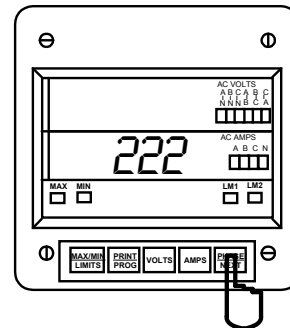

⇒ **222** appears confirming a successful print command.

4.7 LED TEST FROM OPERATING MODE

The EPM3000P is equipped with an LED test to check if the LEDs and annunciators are functioning properly.

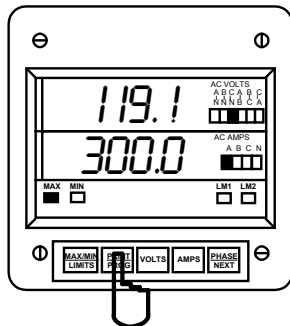

Step 1:
a. Press **PRINT/PROG** to enter the Access Mode.

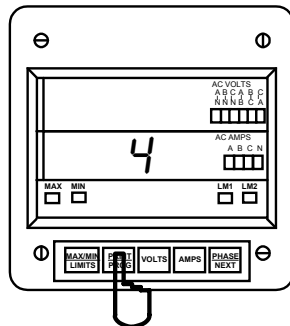

Step 2:
⇒ The display blanks.

a. Press **PRINT/PROG** until **4** appears.

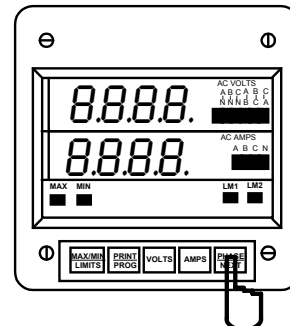

Step 3:
a. Press **PHASE/NEXT** for the LED test.

⇒ All segments and annunciators glow.

4.8 ACCESSING FIRMWARE VERSION FROM OPERATING MODE

The EPM3000P is equipped with a function to access the firmware version.

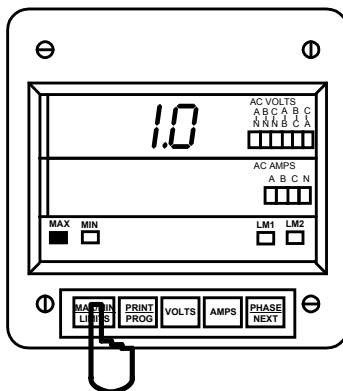

Step 1:
a. Disconnect power to the meter.

b. Press **MAX/MIN/LIMITS** upon power up.

⇒ Upper display indicates the version number.

PROGRAMMING YOUR EPM3000P

CHAPTER 5

GENERAL PROCEDURE OVERVIEW

5.1 HOW TO USE THIS PORTION OF THE MANUAL

This manual contains programming for basic operation, available options and parameters. Using the Table of Contents or "Quick Reference Guide", find the programming feature location and read that chapter.

Programming tasks are arranged into nine major GROUPS. Within each GROUP are the specific meter FUNCTIONS. Outlined is the general approach to alter programming mode values.

1. Enter the Programming Mode.
2. Select the desired GROUP.
3. Select a FUNCTION within the GROUP.
4. After the FUNCTION selection, proceed with DATA ENTRY of the new value for the desired parameter.
5. Proceed to program another location and/or exit the programming mode.

IMPORTANT: THE FULL EXITING PROCEDURE MUST BE FOLLOWED TO STORE ANY NEW PROGRAMMING.

5.2 SWITCH PACKS

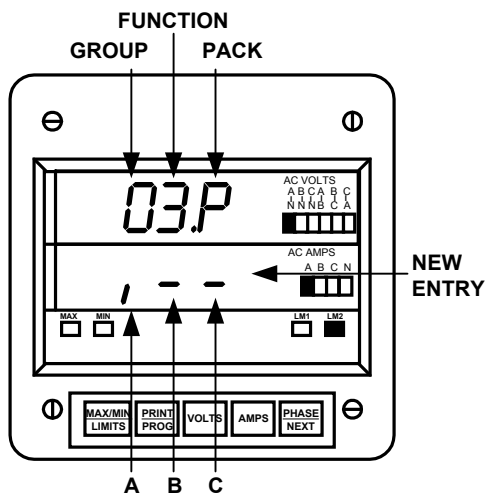

GROUPS, Functions, and Switch PACKS:

- GROUPS are the main category.
- Functions are sub categories of GROUPS.
- Switch PACKS are sub categories of Functions.

THE DIAGRAM BELOW ILLUSTRATES THE ARRANGEMENT OF THE THREE CATEGORIES:

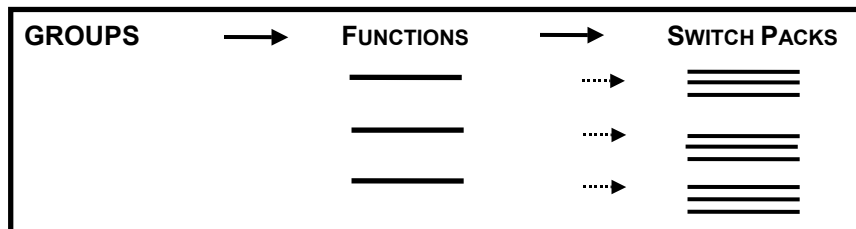

NOTE: THESE ARE VERY SIMILAR TO DIP SWITCH CONCEPT.

5.3 PROGRAMMING MODE ENTRY

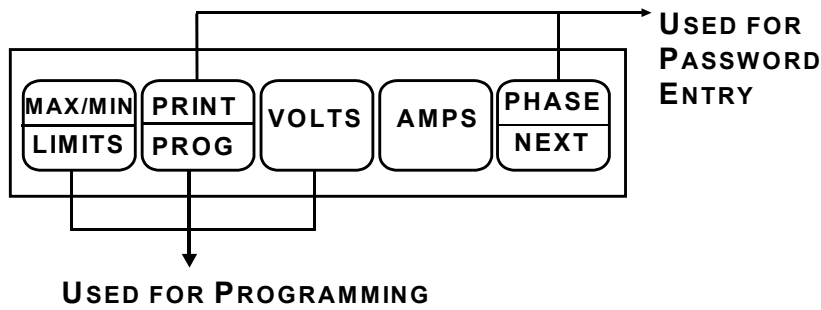

BUTTON	FUNCTION	DESCRIPTION
MAX/MIN/LIMITS	ADVANCE	Scrolls groups, functions, and advances to exit point from function and group level.
PRINT/PROG	CHANGE VALUE	Scrolls packs, digit counters, and changes Switch PACK position UP or DOWN.
VOLTS	STORE	Activates new data entry, stores digits, and enters or exits from group or function level.

5.4 STANDARD NUMERIC DATA ENTRY

Programmable FUNCTION values are always three digit numeric fields designed to accept any value between 000 and 1999. When entering the value of a function enter all three digits, leading zero's included. For instance, to enter 25, enter: 025.

When activating the Data Entry Sequence, certain Functions allow for a four digit entry. The display indicates a blank followed by three dashes (see diagram). The first digit may only be a **1** or a **blank** (the blank signifying 0). Press **PRINT/PROG** ONCE for 0, TWICE for 1.

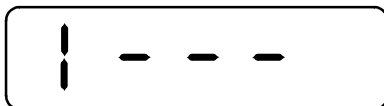

CHAPTER 6

ENTERING THE PROGRAMMING MODE

6.1 CHECKSUM ERROR - PROTECTIVE MECHANISM

If the control power is interrupted while in Programming Mode or the user does not fully exit, the meter enters a checksum mode. The display blanks, except for the max LED. Press **PRINT/PROG** for several seconds and the unit recovers. Follow the procedure to enter the Programming Mode to check program data, then exit.

6.2 PASSWORD ENTRY

The EPM3000P is password protected. To enter the programming mode, key in the following password. The password is **555**.

NOTE: THE METER WILL NOT STORE ANY PROGRAMMING UNLESS PROPERLY EXITED. (SEE CHAPTER 11 TO EXIT).

⇒ ENTERING THE PROGRAMMING MODE:

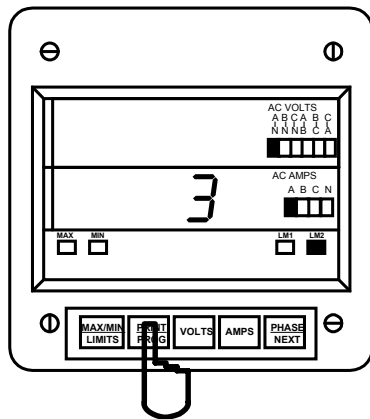

Step 1:

- Press **PRINT/PROG** until **3** appears in lower display.
- Press **PHASE/NEXT** to select.
- 333** appears in lower display.

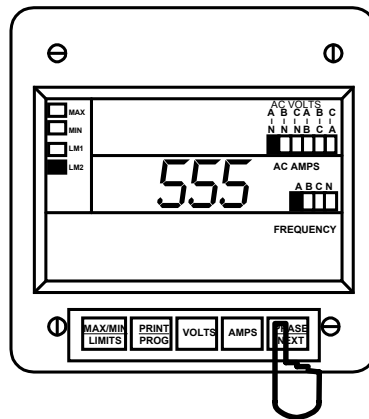

Step 2:

- ⇒ Digits begin scrolling in upper display.
- ⊗ The password is **555**.
- a. Press **PHASE/NEXT** each time **5** appears.
- ⇒ The selected digits appear in lower display.

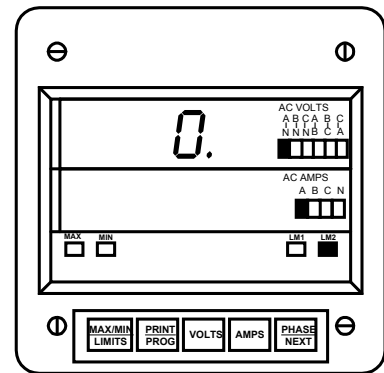

⇒ Display blanks and **PPP** flashes in upper display, confirming a correctly entered password.

⇒ **PPP** is replaced by **0**, and the meter is now in the Programming Mode, GROUP 0.

CHAPTER 7

PROGRAMMING GROUP 0: GLOBAL METER SETUP

The Global Meter Setup includes Functions 0 through 5 that control configuration and basic operation. Below is an outline of GROUP 0 to assist in locating a feature. FUNCTION 3 System Configuration contains Switch PACKS with various options, including open delta installation and communications.

TABLE 7-1: GROUP 0 PROGRAMMING FORMAT

FUNCTION NUMBER	FUNCTION
0.	Integration Interval
1.	Meter Address for Communication
2.	Baud Rate for Communication
3.	System Configuration
4.	Relay 1 Set-up/Time Delay
5.	Relay 2 Set-up/Time Delay
E.	Exit Programming GROUP 0

7.1 GROUP 0, FUNCTION 0 - THE INTEGRATION INTERVAL

INTEGRATION INTERVAL: The time over which all instantaneous readings are averaged to obtain a maximum and minimum demand. The Integration Interval is entered in seconds. When entering 15 minutes, enter: 0900 seconds.

⇒ To change the **INTEGRATION INTERVAL**, follow these steps:

NOTE: PRESS **MAX/MIN/LIMITS**, AT ANY TIME, TO CANCEL BEFORE STORING THE LAST DIGIT OR SWITCH.

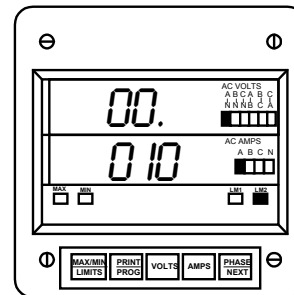
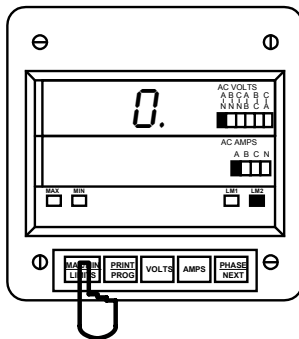

Step 1:

- a. Enter Group Level of Programming Mode, (see Chapter 6).
- b. Press **MAX/MIN/LIMITS** until **0.** appears in upper display.
- c. Press **VOLTS** to activate the GROUP.

⇒ **00.** appears in upper display, indicating current Group and Function number.

⇒ Lower display indicates current Interval setting.

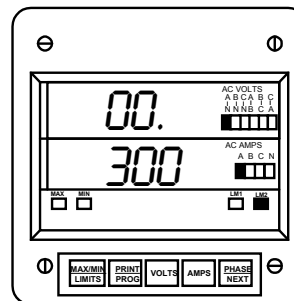
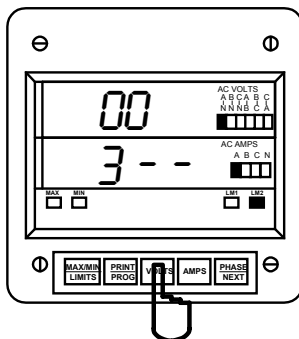

Step 2:

- a. Press **VOLTS** to begin Data Entry Sequence.
⇒ Three dashes appear in lower display.
- b. Press **PRINT/PROG** for desired number. Press **PRINT/PROG** once and the blank signifies zero. Press **PRINT/PROG** twice and **1** appears.
- c. Press **VOLTS** to store.

⇒ Repeat this procedure until new Integration Interval is entered.

⇒ When complete, lower display indicates new Integration Interval.

See Chapter 12 to Exit.

7.2 GROUP 0, FUNCTION 1 - THE METER ADDRESS

METER ADDRESS: Identifies the meter when communicating with a computer system or an RS485 bus. When numerous meters are at one site, it is essential that each meter have its own address.

⇒ To change the **METER ADDRESS**, follow these steps:

NOTE: PRESS **MAX/MIN/LIMITS**, AT ANY TIME, TO CANCEL BEFORE STORING THE LAST DIGIT OR SWITCH.

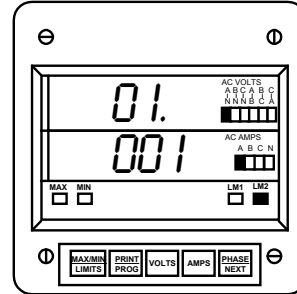
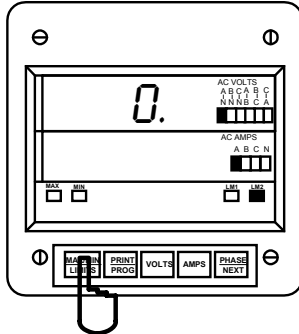

Step 1:

- a. Enter Group Level of Programming Mode, (see Chapter 10).
- b. Press **MAX/MIN/LIMITS** until **0.** appears in upper display.
- c. Press **VOLTS** to activate the GROUP.

- ⇒ **01.** appears in upper display.
- ⇒ Lower display indicates the current Meter Address.

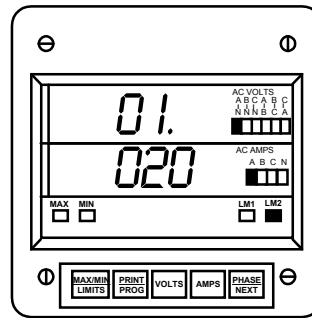
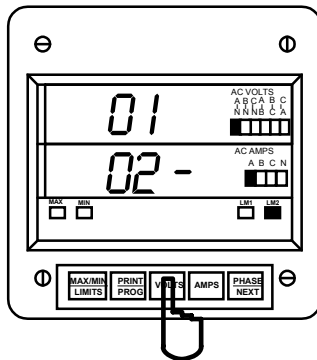

Step 2:

- a. Press **VOLTS** to activate Data Entry Sequence.
 - ⇒ Three dashes appear in lower display.
- b. Press **PRINT/PROG** for desired number.
 - Press **PRINT/PROG** once and the blank signifies a zero.
 - Press **PRINT/PROG** twice and **1** appears.
- c. Press **VOLTS** to store.

- ⇒ Repeat this procedure until new Address is entered.
- ⇒ When complete, lower display indicates new Address.

See Chapter 12 to Exit.

7.3 GROUP 0, FUNCTION 2 - COMMUNICATION BAUD RATE

BAUD RATE: Speed at which data is transmitted between device and remote computer. The rate programmed into the meter must match the rate used by the remote polling device.

Valid Baud Rates are 1200, 2400 and 4800. When entering a baud rate, the last zero is omitted. Therefore, three digits and a leading zero (or blank) must be entered. Example: To enter a baud rate of 2400, enter 0240.

⇒ To change the **COMMUNICATION BAUD RATE**, follow these steps:

NOTE: PRESS **MAX/MIN/LIMITS**, AT ANY TIME, TO CANCEL BEFORE STORING THE LAST DIGIT OR SWITCH.

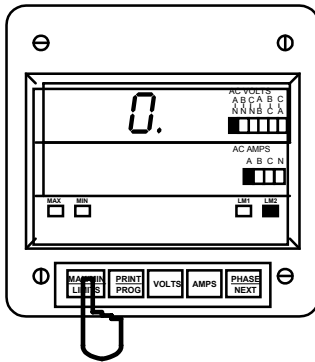

Step 1:

- Enter Group Level of Programming Mode (see Chapter 6).
- Press **MAX/MIN/LIMITS** until **0.** appears in upper display.
- Press **VOLTS** to activate the Group.

⇒ **02.** appears in upper display.

⇒ Lower display indicates current Baud Rate.

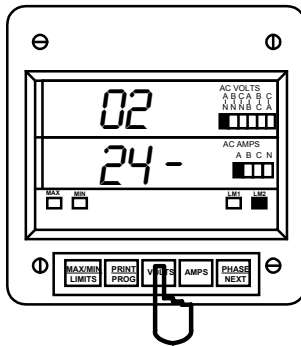
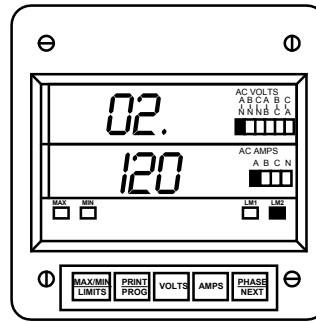

Step 2:

- Press **VOLTS** to begin Data Entry Sequence.
- Three dashes appear in lower display.
- Press **VOLTS** to select.

⇒ Repeat this procedure until new Communication Baud Rate is entered.

⇒ When complete, lower display indicates new Baud Rate.

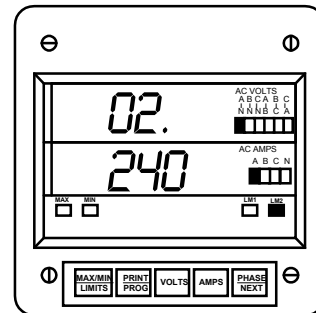

See Chapter 12 to Exit.

7.4 GROUP 0, FUNCTION 3 - SYSTEM CONFIGURATION

The System Configuration Function is used to set basic meter operational parameters. (This Function utilizes Switch PACKS).

FUNCTION 3 contains six Switch PACKS, 0 - 5. Each PACK contains three individual UP/DOWN (toggle) switches.

- Toggling the segment **UP** and **DOWN**, toggles the switch **ON** and **OFF** respectively, or chooses between two options.
- The meter displays one Switch PACK at a time.

⇒ Press **PRINT/PROG** to scroll from PACK to PACK.

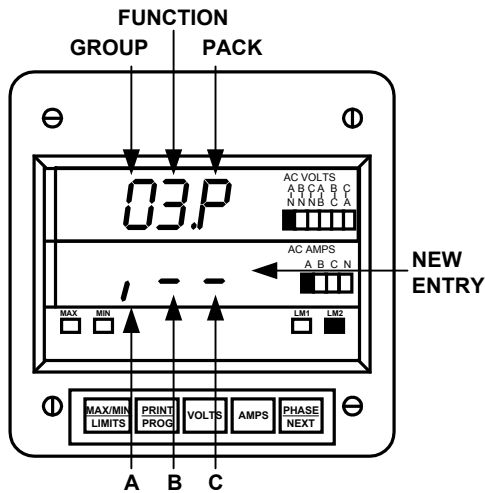

TABLE 7-2: SWITCH FEATURES

PACK	SWITCH	FEATURE	SEGMENT POSITION
0	A	Reserved	-
	B	Reserved	-
	C	Reserved	-
1	A	Reserved	-
	B	Blank non-significant leading zero(s)	UP ⇒ Enable DOWN ⇒ Disable
	C	Reset Protection (See User's Installation & Operation Section)	UP ⇒ Enable DOWN ⇒ Disable
2	A	Reserved	-
	B	Open Delta Installation	UP ⇒ Enable DOWN ⇒ Disable
	C	Reserved	-
3	A	Reserved	-
	B	Reserved	-
	C	Reserved	-
4	A	Relay Control I	UP ⇒ Alarm Only DOWN ⇒ Computer Control & Alarm
	B	Relay Control II	UP ⇒ Alarm Only DOWN ⇒ Computer Control & Alarm
	C	-	UP ⇒ Comm. DOWN ⇒ Disable Comm. and Print
5	A	-	UP ⇒ Print DOWN ⇒ Disable Print

NOTE: TO PRINT: PACK 4, SWITCH C MUST BE IN THE UP POSITION.

7.5 GROUP 0, FUNCTION 3 - PROGRAMMING PROCEDURE

⇒ To change the **SYSTEM CONFIGURATION SWITCH** settings, follow these steps:

NOTE: PRESS **MAX/MIN/LIMITS**, AT ANY TIME, BEFORE STORING THE LAST DIGIT OR SWITCH.

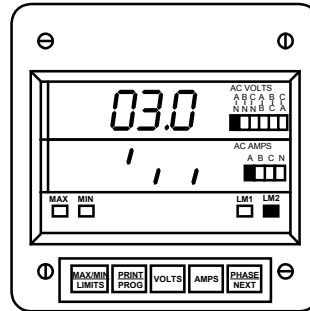
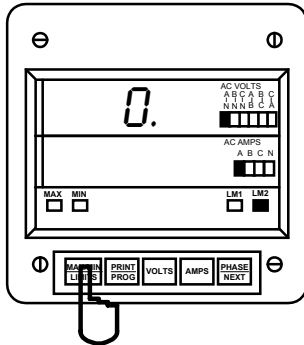

Step 1:

- a. Enter Group Level of Programming Mode, (see Chapter 6).
- b. Press **MAX/MIN/ LIMITS** until **0.** appears in upper display.
- c. Press **VOLTS** to activate the Group.

⇒ **03.0** appears in upper display.

⇒ Lower display indicates current PACK 0 Switch Settings.

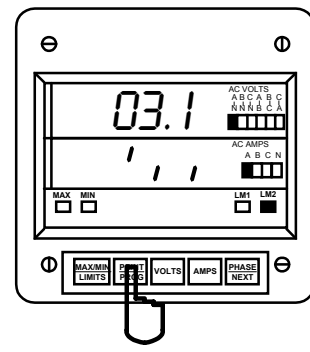
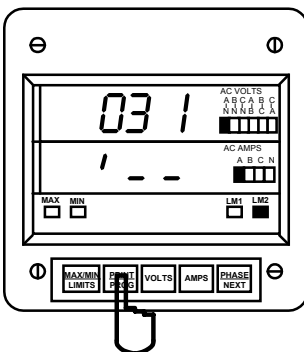

Step 2:

- a. Press **PRINT/PROG** until desired PACK appears.
 - b. Press **VOLTS** to begin Data Entry Sequence.
- ⇒ Three dashes appear in lower display.

Step 3:

- a. Press **PRINT/PROG** to toggle the segments UP or DOWN for desired setting.
- b. Press **VOLTS** to store

See Chapter 12 to Exit.

7.6 GROUP 0, FUNCTIONS 4-5 - TIME DELAY FOR RELAYS 1 & 2 (OPTION NL)

The EPM3000P can be equipped with a relay option. Two relays are included in this option. The relays can be used in computer controlled or dedicated alarm options.

COMPUTER CONTROLLED

The relays can be locked or unlocked through a computer (must have communication option).

DEDICATED ALARM

The relays can be locked or unlocked using the meter's keypad or its measured inputs. The computer cannot change the state of the relay.

Under GROUP 0, FUNCTIONS 4-5, time delay for the Relays 1 or 2 can be set between 0 - 255 seconds. This allows conditions to exist for a specified time period before the relay or alarm activates. If a time greater than 255 seconds is entered, the meter defaults to the maximum value of 255 seconds.

EXAMPLE 1:

Relay 1 will be “SET” once the reading exceeds 5.00 amps. Relay 1 will be “RESET” once the reading falls below 5.00 amps.

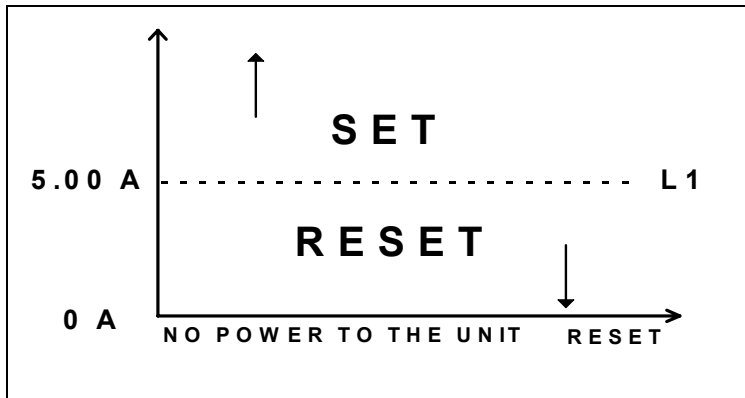

1. Enter in GROUP 0, FUNCTION 4, Segment C and D: UP, DOWN
2. Enter in GROUP 4, FUNCTION 2, LIMIT 1, Segments B, C, and D: UP, UP, DOWN

EXAMPLE 2: NORMALLY RESET - NON-EVENT CONDITION WILL RESET RELAY

Relay 1 will be “SET” if the instantaneous reading for amps is below 4.00 amps or above 5.00 amps. Under all other conditions the relay will be “RESET”.

NOTE: UNDER THIS SETUP THE RELAY WILL NOT ACT AS A PROTECTIVE SWITCH.

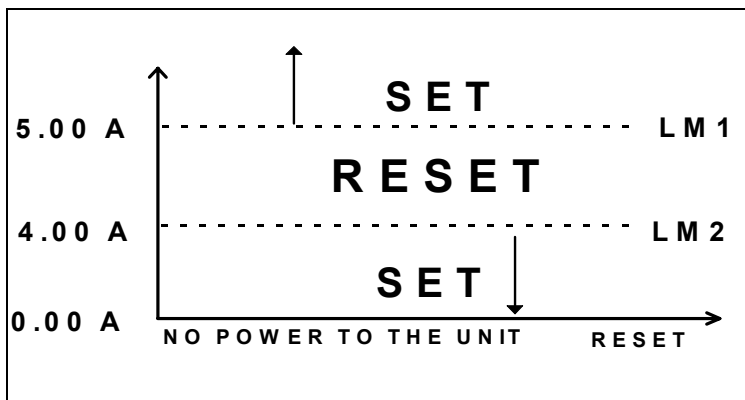

PROGRAMMING STEPS:

1. Enter in GROUP 0, FUNCTION 4, Segments C and D: UP, UP
2. Enter in GROUP 4, FUNCTION 2, LIMIT 1, Segments: B, C, and D: UP, UP, DOWN. Value: 5.00
3. Enter in GROUP 4, FUNCTION 2, LIMIT 2, Segments: DOWN, UP, DOWN. Value: 4.00

⇒ To change the **TIME DELAY FOR RELAY 1 OR RELAY 2**, follow these steps:

PRESS **MAX/MIN/LIMITS**, AT ANY TIME, TO CANCEL BEFORE STORING THE LAST DIGIT OR SWITCH.

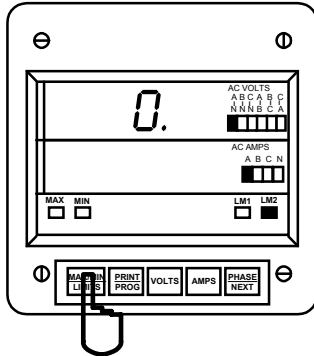

Step 1:

- a. Enter Group Level of Programming Mode (see Chapter 6).
- b. Press **MAX/MIN/LIMITS** until **0.** appears.
- c. Press **VOLTS** to activate the Group.

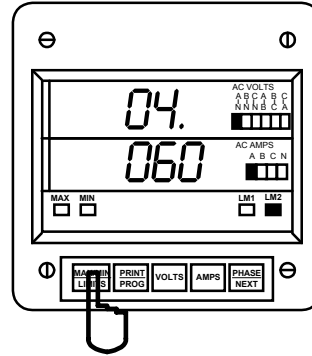

Step 2:

To program Relay 1:

- a. Press **MAX/MIN/LIMITS** until **04.** appears in upper display.

To program Relay 2:

- a. Press **MAX/MIN/LIMITS** until **05.** appears in upper display.

⇒ Lower display indicates current Time Delays.

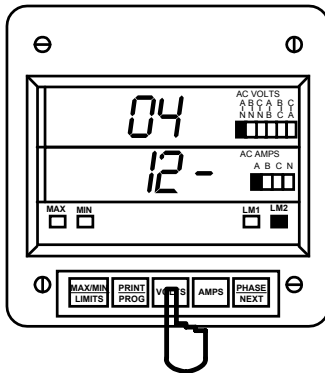

Step 3:

- a. Press **VOLTS** and two dashes appear in lower display.
- b. Press **MAX/MIN/LIMITS** and three dashes appear in lower display.
- c. Press **PRINT/PROG** for desired number.
 - Press **PRINT/PROG** once and the blank signifies a zero.
 - Press **PRINT/PROG** twice and **1** appears.
- d. Press **VOLTS** to store.

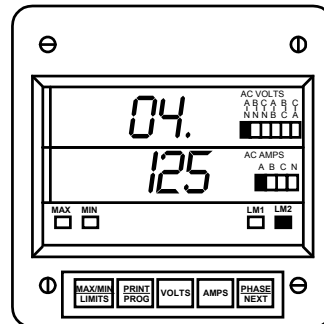

⇒ Repeat this procedure until desired value is entered.

⇒ Lower display indicates the current Time Delay.

See Chapter 12 to Exit.

CHAPTER 8

PROGRAMMING GROUP 1

8.1 SCALE SELECTIONS AND FULL SCALE SETTINGS

Programming GROUP 1 functions provide a selection of Full Scale Settings to accommodate the different CT's and PT's. The decimal point may be positioned for maximum resolution. The user can perform Scale Selection in each function. The site technician has a choice of Full Scale selection between volts and kilovolts or amps and kiloamps.

NOTE: DUE TO THE RESOLUTION CAPABILITY, READINGS OVER 2000 COUNTS RESULT IN A LESS STABLE MEASUREMENT.

⇒ Tables 8-0 and 8-1 contain Full Scale settings for typical voltages and currents (PT and CT arrangements):

TABLE 8-0

INPUT VOLTAGE	PT RATIO	FULL SCALE
120/208V	1:1 (DIRECT)	120V
120/208V	4:1	480V
120/208V	12:1	1.44KV
277/480V (SUFFIX G)	1:1 (DIRECT)	300V

TABLE 8-1

INPUT CURRENT	CT TYPE	FULL SCALE
0 - 5A	NONE	5.00A
0 - 1000A	1000/5	1000A
0 - 5000 A	5000/5	5.00KA

TABLE 8-2: GROUP 1 PROGRAMMING FORMAT

FUNCTION NUMBER	FUNCTION
0.	Full Scale Selection for Volts
1.	Full Scale Selection for Amps
E.	Exit Programming GROUP 1

8.2 GROUP 1, FUNCTIONS 0-1: FULL SCALE SETTINGS, VOLT & AMP CHANNELS, VOLT & AMP DECIMAL PLACEMENT

⇒ To change the **VOLT OR AMP FULL SCALE** settings (Function 0 and 1, respectively), follow these steps:

NOTE: PRESS **MAX/MIN/LIMITS**, AT ANY TIME, TO CANCEL BEFORE STORING THE LAST DIGIT OR SWITCH.

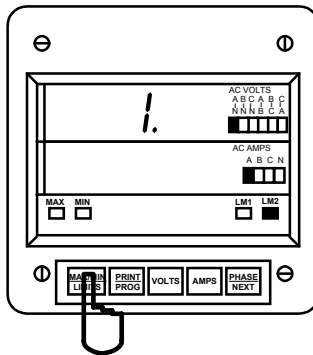

Step 1:

- a. Enter Group Level of Programming Mode, (see Chapter 6).
- b. Press **MAX/MIN/LIMITS** until **1.** appears in upper display.
- c. Press **VOLTS** to activate the Group.

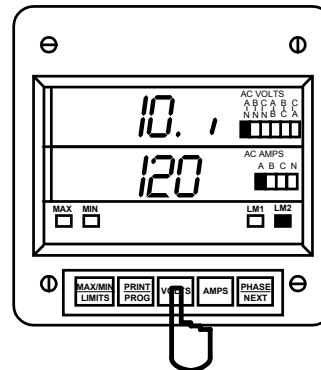

Step 2:

- ⇒ **10.** appears in upper display.
 - ⇒ Lower display indicates Full Scale setting.
 - ⇒ A segment appears in upper display.
 - ⇒ UP signifies - *Kilovolts*.
 - ⇒ DOWN signifies - *Volts*.
- a. Press **VOLTS** to begin Data Entry Sequence.

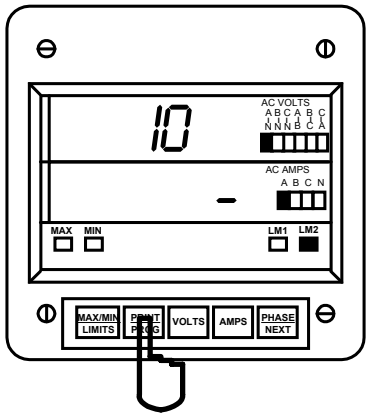

ENTERING THE FULL SCALE FACTOR

Step 3:

⇒ A dash appears in lower display.

- a. Press **PRINT/PROG** to move the segment UP or DOWN.
- b. Press **VOLTS** to store.

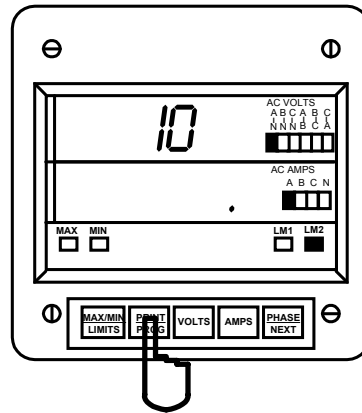

DECIMAL POINT SELECTION

Step 4:

a. Press **PRINT/PROG** to begin decimal placement.

b. Press **VOLTS** to store

⇒ **NOTE:** THE DECIMAL POINT FOR 1999. DOES NOT APPEAR ON THE DISPLAY.

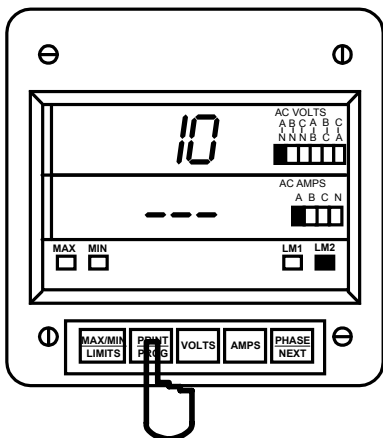

Step 5:

⇒ Three dashes appear in lower display.

- a. Press **PRINT/PROG** for desired number.
 - Press **PRINT/PROG** once and the blank signifies a zero.
 - Press **PRINT/PROG** twice and **1** appears.
- b. Press **VOLTS** to store.

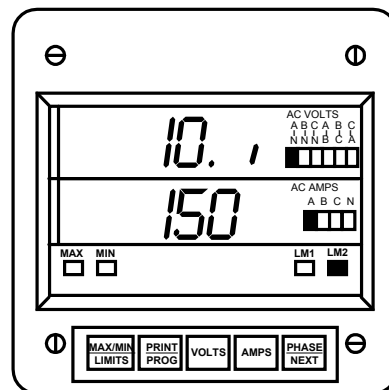

⇒ Repeat this procedure until desired value is entered

⇒ When complete, lower display indicates new Full Scale setting.

See Chapter 12 to Exit.

CHAPTER 9

PROGRAMMING GROUP 2: METER CALIBRATION

9.1 STANDARD CALIBRATION

WARNING - READ THIS SECTION CAREFULLY BEFORE PROCEEDING

- ☒ Calibration does not need to be accomplished to change CT or PT ratios. (See GROUP 1).
- ☒ Meter calibration cannot be performed if the meter is installed for service. The sensing must be connected to a power supply with variable voltage and separate current outputs.
- ☒ **The calibration procedure requires highly accurate and stable input signals.** Incorrect readings result from improper calibration procedures. If unsure, return unit to the factory for calibration.
- ☒ **BEFORE** calibrating any channel, make note of its Full Scale Setting (see Ch. 8). Set the Full Scale in accordance with Table 9-1 for calibration. Restore original Full Scale Setting when calibration is completed.
- ☒ The first function in GROUP 2 (STD.CORR) is **NOT** to be changed by the user. Please make note of the value here (□□□□) before using any other function in this Group. If the STD.CORR value is inadvertently lost or changed, contact the factory for assistance.

All sensitive electronic measuring devices *drift* slightly over time, requiring periodic calibration. We recommend returning the meter to the factory on a yearly basis.

TABLE 9-0: GROUP 2 PROGRAMMING FORMAT

FUNCTION NUMBER	FUNCTION
P.	Standard Correction. Factory Procedure only.
0.	High End Calibration, VOLTS AN
1.	High End Calibration, VOLTS BN
2.	High End Calibration, VOLTS CN
3.	High End Calibration, AMPS A
4.	High End Calibration, AMPS B
5.	High End Calibration, AMPS C
6.	Low End Calibration, AMPS A
7.	Low End Calibration, AMPS B
8.	Low End Calibration, AMPS C
E.	Exit Programming GROUP 2

The Full Scale and Calibration values should be equal during the calibration procedure. The meter may be rescaled without calibrating by changing the full scale in GROUP 1, FUNCTION 0 or 1. (See Table 9-1)

TABLE 9-1: SOURCE, FULL SCALE AND VALUE SETTINGS FOR CALIBRATION

CALIBRATION TYPE/ RANGES	CALIB. SOURCE NECESSARY	FULL SCALE SETTING	CALIBRATION VALUE
VOLTS 120/208V	120V	120V	120
VOLTS 277/480V	300V	300V	300
VOLTS 4/1 PT	120V	480V	480
VOLTS 60/1 PT	120V	7.20KV	7.20
AMPS Hi End 1000/5 CT	5A	1000A	1000
AMPS Hi End 5000/5 CT	5A	5.00KA	5.00
AMPS Lo End 1000/5 CT	2.5A		500
AMPS Lo End 5000/5 CT	2.5A		2.50

9.2 GROUP 2, FUNCTIONS 0-8: HIGH END CALIBRATION OF VOLTAGE CHANNELS, HIGH & LOW END CALIBRATION OF AMPERAGE CHANNELS

⇒ To change the **CALIBRATION**, follow these steps:

NOTE: PRESS **MAX/MIN/LIMITS**, AT ANY TIME, TO CANCEL BEFORE STORING THE LAST DIGIT OR SWITCH.

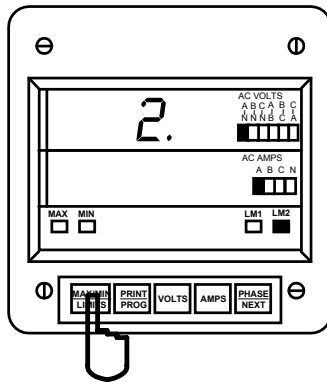

Step 1:

- a. Enter Group Level of Programming Mode, (see Chapter 6).
 - b. Press **MAX/MIN/LIMITS** until **2.** appears in upper display.
 - c. Press **VOLTS** activate the Group.
- ⇒ A one-digit password is required to continue.
- d. Press **PRINT/PROG** until **5** appears.
 - e. Press **VOLTS** to select.

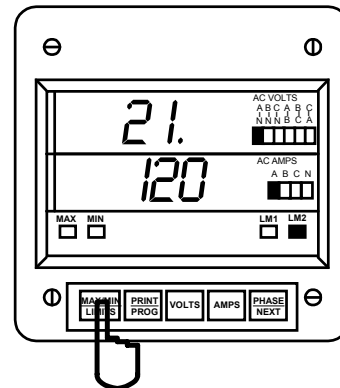

Step 2:

- ⇒ Refer to Table 9-0 for Function Number that corresponds to channel requiring calibration.
- a. Press **MAX/MIN/LIMITS** (to calibrate VOLTS BN) until **21.** appears in upper display.
- ⇒ (2P is pre-calibrated. This is a factory set value and should not be altered).

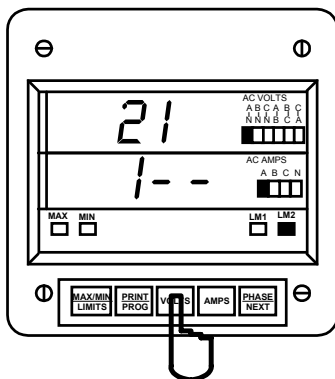

Step 3:

⇒ Apply the calibration to the appropriate channel.

- a. Press **VOLTS** to activate calibration.
- b. Press **PRINT/PROG** for desired number.

Press **PRINT/PROG** once and the blank signifies a zero.
Press **PRINT/PROG** twice and **1** appears.

- c. Press **VOLTS** to store.

⇒ When complete, lower display indicates the calibrated reading after **10-15 seconds**.

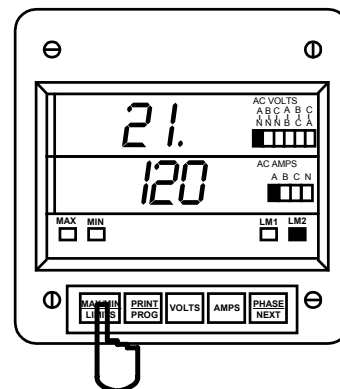

Step 4:

- a. Press **MAX/MIN/LIMITS** to exit calibration sequence.

⇒ Proceed to calibrate another function, or exit.

See Chapter 12 to Exit.

○ REPEAT THIS PROCEDURE FOR FUNCTIONS 0 - 5.

○ FOR FUNCTIONS 6 THROUGH 8, FOLLOW THESE STEPS:

NOTE: PRESS **MAX/MIN/LIMITS**, AT ANY TIME, TO CANCEL BEFORE STORING THE LAST DIGIT OR SWITCH.

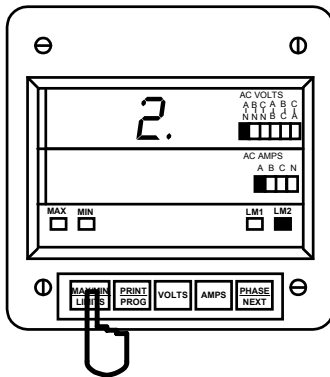

Step 1:

- a. Enter Group Level of Programming Mode, (see Chapter 6).
- b. Press **MAX/MIN/LIMITS** until 2. appears in upper display.
- c. Press **VOLTS** to activate the Group.
⇒ A single dash appears indicating a one-digit password is required to continue.
- d. Press **PRINT/PROG** until 5 appears.
- e. Press **VOLTS** to select.

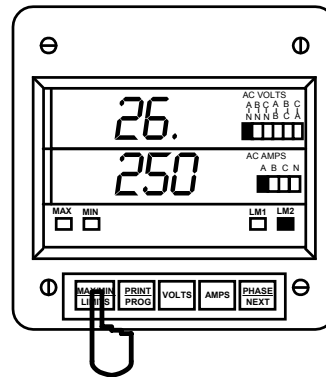

Step 2:

- a. Press **MAX/MIN/LIMITS** until 26. appears in upper display.
- b. Press **VOLTS** to activate.
⇒ Lower display blanks.
⇒ After **10 seconds**, three dashes appear in lower display.

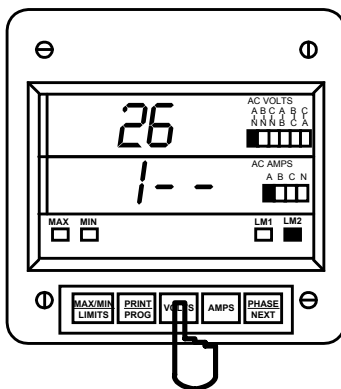

Step 3:

- a. Press **PRINT/PROG** for desired number.
- b. Press **VOLTS** to store.
⇒ When complete, lower display indicates the calibrated reading after **10-15 seconds**.

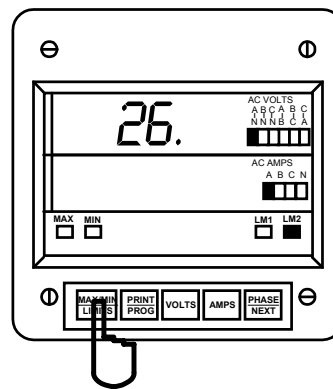

Step 4:

- a. Press **MAX/MIN/LIMITS** at exit calibration sequence.
⇒ Proceed to calibrate another function, or exit.

See Chapter 12 to Exit.

CHAPTER 10

PROGRAMMING GROUP 4: SET LIMITS & RELAYS

GROUP 4 contains LM1 and LM2 set limit values for the voltage and amperage scale allowing the user to program the limits for the following Groups: VOLTS phase-to-neutral, VOLTS phase-to-phase, AMPS A, B, C, and AMPS neutral.

DIAGRAM 10.1: EXAMPLE OF LM1/LM2 SET LIMITS, VOLTS AND AMPS

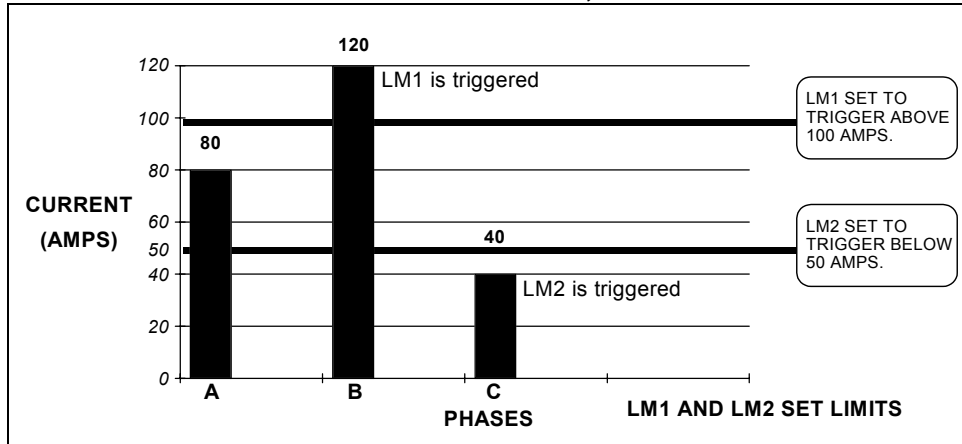

10.1 TRIP RELAY

The EPM3000P has two Relays. These relays are linked through the program to Set Limits LM1 and LM2. The user can program above or below set limits for every reading. When a measurement exceeds a particular value, the set limit triggers and alerts the user. Each relay is programmed to a separate delay time (see Chapter 8).

NOTE: EACH LIMIT CAN BE PROGRAMMED TO TRIGGER THE TWO INTERNAL FORM C DRY CONTACT RELAYS FOR ALARM OR SECONDARY PROTECTION.

GROUP 4: SET LIMITS FOR VOLTS/AMPS

TABLE 10-0: GROUP 4 PROGRAMMING FORMAT

FUNCTION NUMBER	FUNCTION
0.	LM1/LM2 Set Limits for Volts AN,BN,CN
1.	LM1/LM2 Set Limits for Volts AB,CB,CA
2.	LM1/LM2 Set Limits for Amps A,B,C
3.	LM1/LM2 Set Limits for Amps Neutral
E.	Exit Programming GROUP 4

NOTE: IN TABLE 10-0, ALL FUNCTIONS HAVE A TWO PART ENTRY.

Part 1: The first switch sets the limit to trip either above or below the limit value.
 The second switch sets whether Relay 1 will trip when the condition occurs.
 The third switch sets whether Relay 2 will trip when the condition occurs.

Part 2: The second part is the Limit Value.

□ GROUP 4, FUNCTIONS 0 - 3: LM1/LM2 SET LIMITS

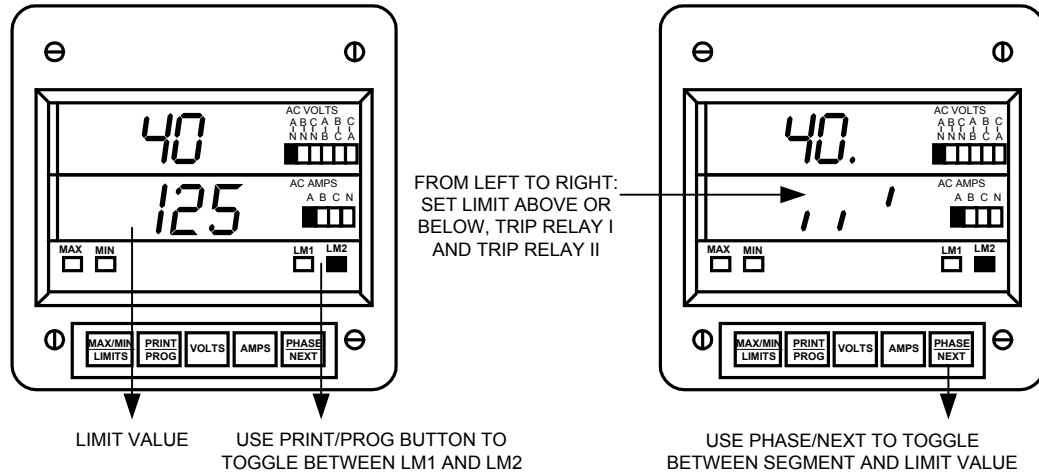

EXAMPLE: FUNCTION 0

LM1 LED	LM2 LED	ABOVE/BELOW	RELAY 1	RELAY 2	VALUE
ON	OFF	Digit Up	Digit Up	Digit Down	120
OFF	ON	Digit Down	Digit Down	Digit Up	090

TABLE 10-1: FUNCTION 0

LM1 LED	LM2 LED	ABOVE/ BELOW	RELAY 1	RELAY 2	LEVEL
ON	OFF	Digit Up-trigger above level Digit Down- trigger below level	Digit Up - enabled Digit Down-disabled	Digit Up- enabled Digit Down- disabled	0-1999
OFF	ON	Digit Up-trigger above level Digit Down-trigger below level	Digit Up- enabled Digit Down-disabled	Digit Up-enabled Digit Down-disabled	0-1999

NOTE: IF VOLTAGES EXCEED 120V, LM1 IS TRIGGERED AND RELAY 1 IS ENABLED. IF VOLTAGES DO NOT EXCEED 90V, LM2 IS TRIGGERED AND RELAY 2 IS ENABLED.

⇒ To program **LIMITS OR RELAYS**, follow these steps:

NOTE: PRESS **MAX/MIN/LIMITS**, AT ANY TIME, BEFORE STORING THE LAST DIGIT OR SWITCH.

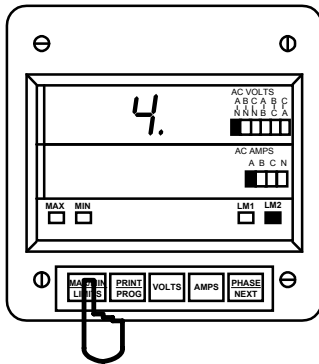

Step 1:

- a. Enter Group Level of Programming Mode, (see Chapter 2).
- b. Press **MAX/MIN/LIMITS** until **4.** appears in upper display.
- c. Press **VOLTS** to activate the Group.

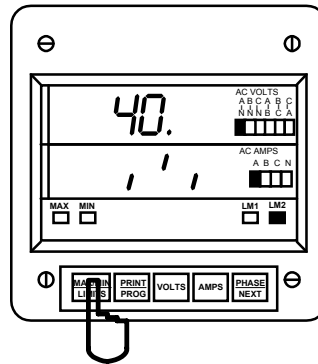

Step 2:

- a. Press **MAX/MIN/LIMITS** to select desired Function (0-3).

⇒ Lower display provides the currently selected value for whether to trip *above* or *below* on Relay 1 and Relay 2.

LEFT SWITCH: UP position indicates above tripping value for lower display's value. DOWN position indicates below tripping value for lower display's value.

MIDDLE SWITCH: UP position sets Relay 1 to trip. DOWN position doesn't activate Relay 1 when limit condition exists.

RIGHT SWITCH: Same as Middle Switch, regarding Relay 2.

- b. Press **PRINT/PROG** to toggle between LM1 and LM2 setting.

⇒ The LM1 or LM2 annunciator indicates the limit being displayed.

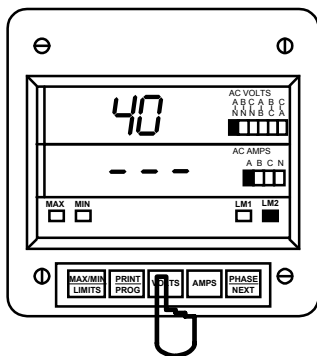

Step 3:

- a. Press **VOLTS** once.

⇒ Lower display is replaced with three dashes.

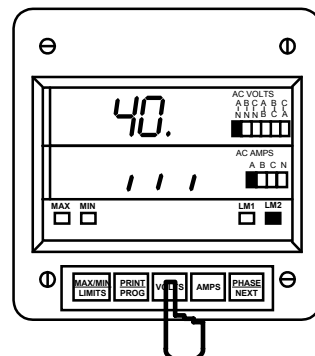

FOLLOW THIS STEP FOR DISABLING THE LIMIT:

- a. Press **VOLTS** (wait 3-6 seconds) to Disable the Limit.

⇒ The *Set Above/ Below* will be set to below.
 ⇒ *Trip Relay 1* will be disabled.
 ⇒ *Trip Relay 2* will be disabled.
 ⇒ The *Level of the Limit* will be set to **000**.

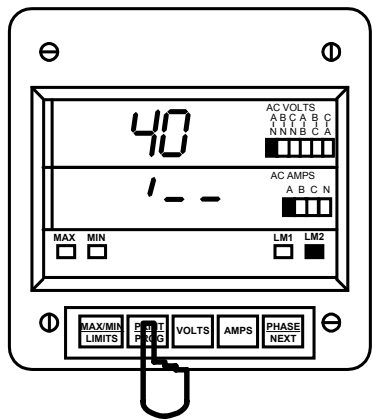

Step 4:

- a. Press **PRINT/PROG** to toggle between LM1 and LM2 settings.
- b. Press **VOLTS** to store.
- c. Press **PRINT/PROG** to change current Set Above/Below, Trip Relay 1, and Trip Relay 2 settings.
⇒ This toggles the segments UP (above limit) or DOWN (below limit).
- d. Press **VOLTS** to store.
- e. Press **MAX/MIN/LIMITS** to enter the limit value.

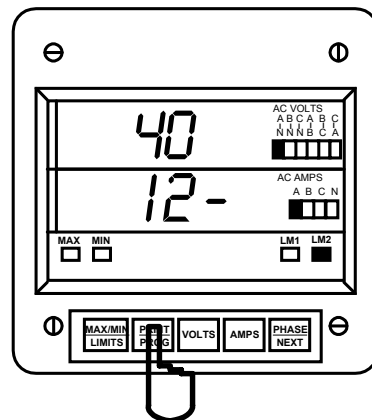

Step 5:

- a. Press **PRINT/PROG** to scroll through the digits.
 - Press **PRINT/PROG** once and the blank signifies a zero.
 - Press **PRINT/PROG** twice and **1** appears.
- b. Press **VOLTS** to store.
⇒ Upon completion, the lower display indicates the new setting.
- c. Press **PHASE/NEXT** to check programmed data.
- d. Press **PRINT/PROG** TO PROGRAM ANOTHER FUNCTION (refer to Step 2).

See Chapter 12 to Exit.

CHAPTER 11

PROGRAMMING GROUP 7: PHASE REVERSAL & PHASE IMBALANCE SET LIMITS/RELAYS

11.1 VOLTAGE PHASE REVERSAL AND PHASE IMBALANCE

The set limit alerts the user of an unbalanced or a reversed phase in a Three-phase System. The EPM3000P has two options for this purpose.

PHASE REVERSAL:

Activates when a reversed phase enters the EPM3000P's metering system.

PERCENT PHASE IMBALANCE:

Activates when the user's present value percent phase imbalance is exceeded. For example: an unbalanced Three-phase System.

DIAGRAM 11.1: EXAMPLE OF SET LIMITS

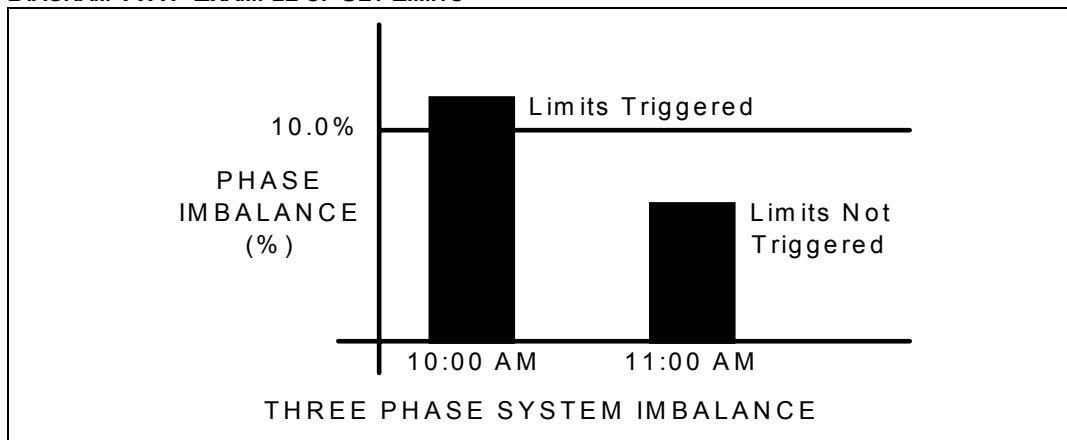

11.2 TRIP RELAY

NOTE: THE -NL OPTION MUST BE PURCHASED TO HAVE RELAYS TRIGGERED FROM LIMIT CONDITIONS.

The EPM3000P has two Relays. These relays are linked through the program to Set Limits LM1 and LM2. The user can program above or below set limits for every reading. When a measurement exceeds a particular value, the set limit triggers and alerts the user. Each relay has provisions for a separate delay time (see Chapter 8).

- ① **TRIP RELAY I** Whether to trip Relay 1.
- ② **TRIP RELAY II** Whether to trip Relay 2.
- ③ **LEVEL** The level at which the warning mechanism trips. Percentage of voltage imbalance is entered for setup level.
-OR-
- ④ **ENABLE/DISABLE** In the event of Phase Reversal, indicates whether to enable or disable phase reversal detection.

TABLE 11-0: GROUP 7 PROGRAMMING FORMAT

FUNCTION NUMBER	FUNCTION
0.	Voltage Phase Reversal Detection
1.	Voltage Phase Imbalance
E.	Exit Programming GROUP 7

11.3 GROUP 7, FUNCTION 0: VOLTAGE PHASE REVERSAL DETECTION

⇒ To change the **PHASE REVERSAL** settings, follow these steps:

NOTE: PRESS **MAX/MIN/LIMITS**, AT ANY TIME, TO CANCEL BEFORE STORING THE LAST DIGIT OR SWITCH.

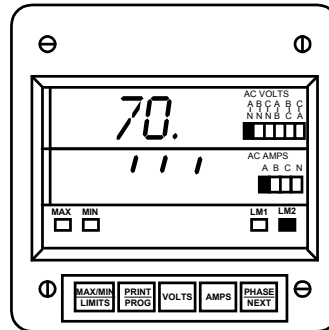
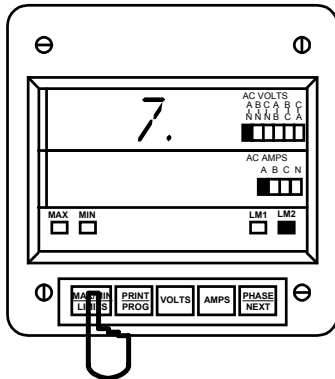

Step 1:

- a. Enter Group Level of Programming Mode (see Chapter 2).
- b. Press **MAX/MIN/LIMITS** until 7. appears in upper display.
- c. Press **VOLTS** to activate the Group.

⇒ 70. appears in upper display.

⇒ Lower display indicates current settings for Enable/Disable Phase Reversal Detection.

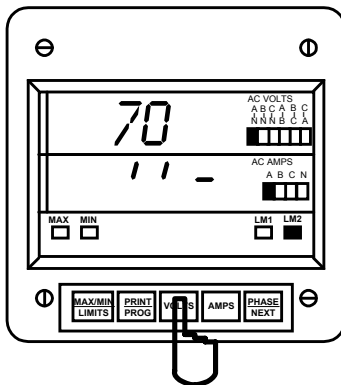

Step 2:

- a. Press **VOLTS** once.
- ⇒ Three dashes appear in lower display.
- b. Press **PRINT/PROG** to change current Set Above/Below, Trip Relay 1, and Trip Relay 2 settings.
- ⇒ This toggles the segments UP (above limit) or DOWN (below limit).
- c. Press **VOLTS** to store.

11.4 GROUP 7, FUNCTION 1: PERCENTAGE VOLTAGE PHASE IMBALANCE

⇒ To change **PERCENTAGE VOLTAGE PHASE IMBALANCE**, follow these steps:

NOTE: PRESS **MAX/MIN/LIMITS**, AT ANY TIME, TO CANCEL BEFORE STORING THE LAST DIGIT OR SWITCH.

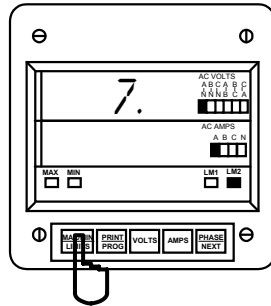

- Step 1:**
- Enter Group Level of Programming Mode, (see Chapter 2)
 - Press **MAX/MIN/LIMITS** until **7.** appears in upper display.
 - Press **VOLTS** to activate the Group.

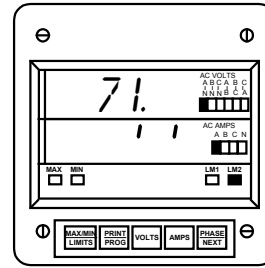

- Press **MAX/MIN/LIMITS** until **71.** appears in upper display.
⇒ Lower display indicates the current Percentage Voltage Phase Imbalance.

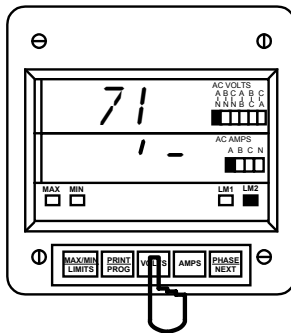

- Step 3:**
- Press **VOLTS** once.
 - Press **PRINT/PROG** to change current Set Above/Below, Trip Relay 1, and Trip Relay 2 settings.
⇒ This toggles the segments UP (above limit) or DOWN (below limit).
 - Press **VOLTS** to store.

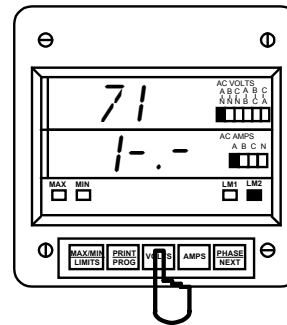

- Step 4:**
- Press **VOLTS** to activate the Percentage Voltage Phase Imbalance.
 - Press **PRINT/PROG** to scroll through the digits.
 - Press **PRINT/PROG** once and the blank signifies a zero.
 - Press **PRINT/PROG** twice and **1** appears.
 - Press **VOLTS** to store.

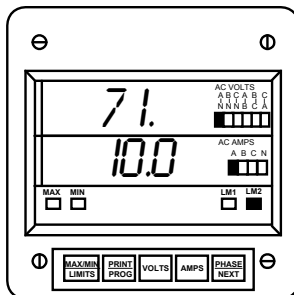

⇒ Lower display indicates the new setting.

See Chapter 12 to Exit.

NOTE: PRESS **PHASE/NEXT** TO TOGGLE BETWEEN NUMBERS AND SEGMENTS. IF A NUMBER GREATER THAN **5** IS ENTERED, THE METER DEFAULTS TO **5**.

CHAPTER 12

EXITING THE PROGRAMMING MODE

NOTE: STEPS TO EXIT THE PROGRAMMING MODE VARIES AS THE PROGRAMMING STAGE VARIES.

Exiting the Programming Mode is **ALWAYS** necessary to store any new changes and to calculate a new checksum. Failure to exit results in a checksum error. The display blanks and the max LED intermittently flashes.

IF YOU ARE LOCATED AT:

FUNCTION LEVEL - begin at **Step 1**

GROUP LEVEL - begin at **Step 2**

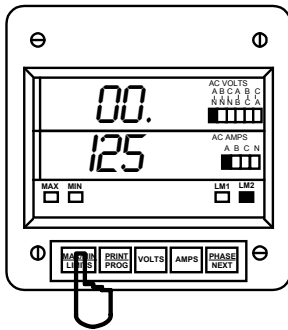

EXITING FROM FUNCTION LEVEL

Step 1:

a. Press **MAX/MIN/ LIMITS** until the Group number in upper display is followed by **E.**

⇒ The EPM3000P returns to Function Level.

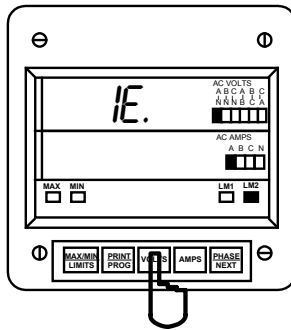

Step 1a:

a. Press **VOLTS** to exit from Function Level to Group Level.

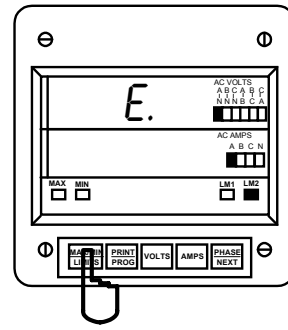

EXITING FROM GROUP LEVEL

Step 2:

a. Press **MAX/MIN/ LIMITS** until **E.** appears in upper display.

b. Press **VOLTS** to exit entirely from Programming Mode.

YOU HAVE EXITED THE PROGRAMMING MODE.

AFTER A MOMENT, THE METER RETURNS TO THE OPERATING MODE.