

**Instruction
manual**

**ROUND HEAD
FRAMING NAILER**



MODEL FR350A

IMPORTANT

Please make certain that the person who is to use this equipment carefully reads and understands these instructions before starting operations.

The Model and Serial No. plate is located on the main housing of the tool. Record these numbers in the spaces below and retain for future reference.

Model No. _____

Type _____

Serial No. _____

To learn more about Porter-Cable
visit our website at:

<http://www.porter-cable.com>

PORTER-CABLE
PROFESSIONAL POWER TOOLS



PORTER+CABLE

Porter-Cable Corporation
4825 Highway 45 North
Jackson, TN 38305

**GB ENGLISH
EC-DECLARATION OF
CONFORMITY**

We declare under our sole responsibility that this product is in conformity with the regulations
EN292-2: section 3 of 1992
EN292-1: section 5 of 1992
EN1050: 1993
EN792 13: 2000

**E ESPANOL
DECLARACION DE
CONFORMIDAD "CE"**

Declaramos bajo nuestra sola responsabilidad que este producto está en conformidad con las regulaciones
EN292-2: section 3 of 1992
EN292-1: section 5 of 1992
EN1050: 1993
EN792 13: 2000

**F FRANÇAISE
DÉCLARATION DE CONFORMITÉ CE**

Nous déclarons sous notre propre responsabilité que ce produit est conforme aux réglementations
EN292-2: section 3 of 1992
EN292-1: section 5 of 1992
EN1050: 1993
EN792 13: 2000

Robert F. Burkholder
Sr. Vice President of Technology

PORTER+CABLE
PROFESSIONAL POWER TOOLS

Date of Manufacture: _____

Fecha de fabricación:, Date de fabrication:

Serial No: _____

Número de serie:, Nombre d'ordre

SAFETY GUIDELINES / DEFINITIONS

This manual contains information that is important for you to know and understand. This information relates to protecting YOUR SAFETY and PREVENTING EQUIPMENT PROBLEMS. To help you recognize this information, we use the symbols below. Please read the manual and pay attention to these sections.

⚠ DANGER indicates an imminently hazardous situation which, if not avoided, will result in death or serious injury.

⚠ WARNING indicates a potentially hazardous situation which, if not avoided, could result in death or serious injury.

⚠ CAUTION indicates a potentially hazardous situation which, if not avoided, may result in minor or moderate injury.

CAUTION used without the safety alert symbol indicates potentially hazardous situation which, if not avoided, may result in property damage.

IMPORTANT SAFETY INSTRUCTIONS

SAVE THESE INSTRUCTIONS!

⚠ WARNING Improper operation or maintenance of this product could result in serious injury and property damage. Read and understand all warnings and operating instructions before using this tool. When using pneumatic tools, basic safety precautions should always be followed to reduce the risk of personal injury.

READ AND FOLLOW ALL INSTRUCTIONS.

⚠ WARNING There are certain applications for which this tool was designed. Porter-Cable strongly recommends that this tool NOT be modified and/or used for any application other than for which it was designed. If you have any questions relative to its application DO NOT use the tool until you have written Porter-Cable and we have advised you.

Technical Service Manager
Porter-Cable Corporation
4825 Highway 45 North
Jackson, TN 38305

▲ DANGER

GENERAL SAFETY RULES

1. Read and understand tool labels and manual. Failure to follow warnings could result in **DEATH** or **SERIOUS INJURY**. Fig. 1.



Fig. 1

2. Operator and others in work area MUST wear safety glasses with side shields. These safety glasses must conform to ANSI Z87.1 requirements (approved glasses have "Z87" printed or stamped on them). Fig. 2.

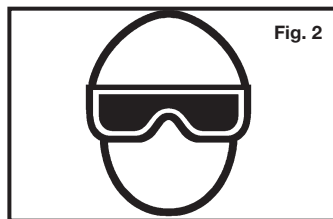

Fig. 2

3. Keep fingers AWAY from trigger when not driving fasteners to avoid accidental firing. Never carry tool with finger on trigger. In "contact actuation mode", tool will fire a fastener if tool is bumped.

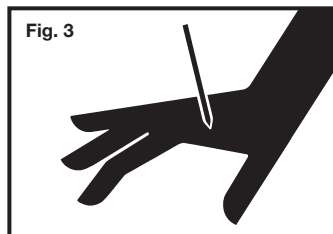

Fig. 3

4. Choice of triggering method is important. Check manual for triggering options. See "Using the Tool with Selectable Triggering Options" section of this manual.

5. Never point tool at yourself or others in work area. Serious injury or death may occur if the tool is activated. Fig. 3

6. Never use oxygen or other bottled gasses. Explosion will occur. Never use combustible gases or any other reactive gas as a power source for this tool: explosion and serious personal injury will result. Fig. 4.

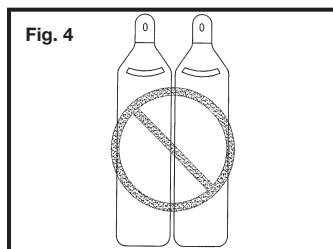

Fig. 4

7. Wear ear protection to safe-guard against possible hearing loss. Ear protection equipment must conform to ANSI S3.19 requirements. Fig. 5.

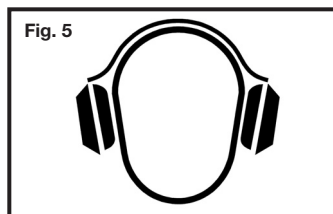

Fig. 5

8. Use clean, dry, regulated, compressed air at 70 to 120 PSI, (4.8 to 8.3 BAR). Fig. 6.

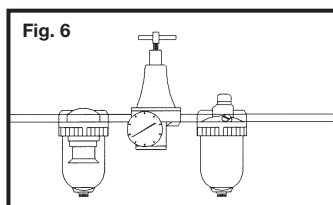

Fig. 6

9. Do not connect tool to pressure which potentially exceeds 200 PSI (13.7 BAR).

10. All air line components (hoses, connectors, filters, regulators, etc.) must be rated for a maximum working pressure of at least 150 PSI (10.3 BAR) or 150% of the maximum system pressure, whichever is greater.

11. Connect tool to air supply hose with a coupling that automatically removes all pressure from the tool when the coupling is disconnected. Fig. 7.

12. Disconnect tool from air supply hose before doing tool maintenance, clearing a jammed fastener, leaving work area, moving tool to another location, or handing the tool to another person. Fig. 7.

13. Never use a tool that is leaking air, has missing or damaged parts, or requires repair. Make sure all screws and caps are securely tightened. Fig. 8.

14. Never use tool if safety, trigger or springs are inoperable, missing or damaged. Do not alter or remove safety, trigger, or springs. Make daily inspections for free movement of trigger and safety mechanism. Fig. 8.

15. Do not use tool without safety warning label. If label is missing, damaged or unreadable, contact your Porter-Cable Service Center for a replacement. Fig. 9.

16. Only use parts, fasteners and accessories approved by Porter-Cable.

17. Connect tool to air supply before loading fasteners, to prevent a fastener from being fired during connection. The tool driving mechanism may cycle when tool is connected to the air supply. Fig. 10.

18. Always assume the tool contains fasteners. No horseplay. Respect the tool as a working implement. Fig. 11.

19. Operator and bystanders should wear hard hats to safeguard against possible injuries. Fig. 12.

20. Do not load fasteners with trigger or safety depressed, to prevent unintentional firing of a fastener. Fig. 13

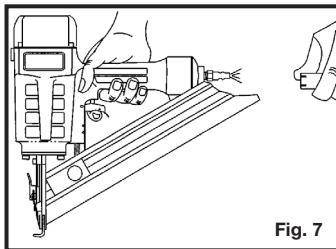

Fig. 7

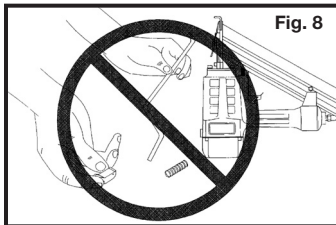

Fig. 8



Fig. 9

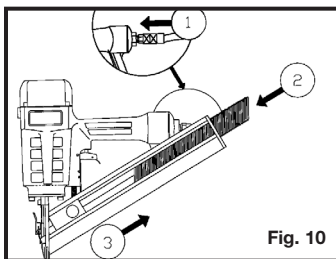

Fig. 10

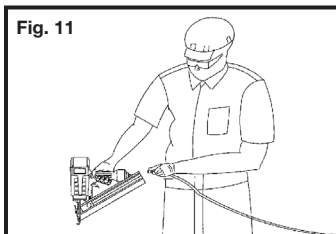

Fig. 11

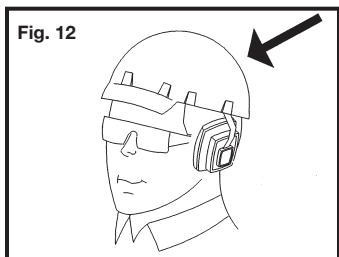

Fig. 12

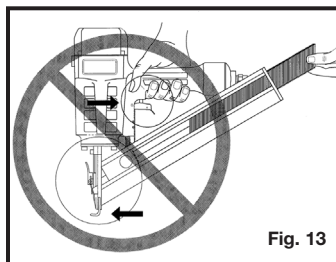

Fig. 13

21. Remove finger from trigger when not driving fasteners. Never carry tool with finger on trigger. In “Contact Actuation Mode” tool will fire a fastener if safety is bumped while trigger is depressed. Fig. 14.

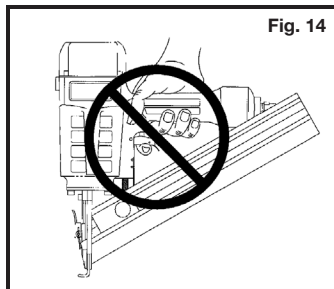

Fig. 14

22. Do not overreach. Keep proper footing and balance at all times when using or handling the tool.

23. Fire fasteners into work surface only: never into materials too hard to penetrate. Fig. 15.

24. Grip tool firmly to maintain control while allowing tool to recoil away from work surface as fastener is driven. In “Contact Actuation Mode” if safety element is allowed to recontact work surface before trigger is released an unwanted fastener will be fired.

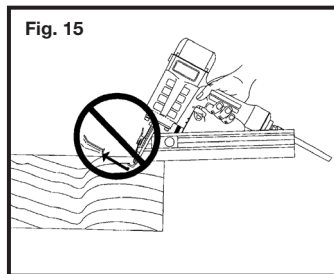

Fig. 15

25. Do not drive fasteners on top of other fasteners, or with the tool at too steep an angle: the fasteners can ricochet causing personal injury. Fig. 15.

26. Do not drive fasteners close to the edge of the workpiece. The workpiece is likely to split allowing the fastener to fly free or ricochet causing personal injury. Fig. 16.

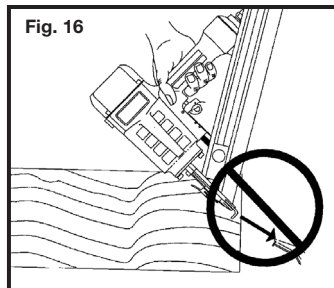

Fig. 16

27. FOR TOOLS SET FOR CONTACT ACTUATION MODE, Do not use on scaffoldings or ladders or for tasks in which changing location involves the use of scaffoldings, stairs, ladders, and the like. Do not use for specific tasks such as closing boxes or crates or fitting transportation safety systems on vehicles and wagons. Fig. 17.

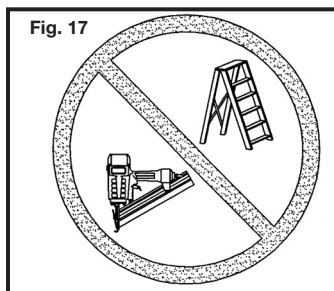

Fig. 17

TECHNICAL SPECIFICATIONS

Noise level

A - Weighted sound impulse
power level 105 dBA

P - Emission sound pressure
pressure level 98 dBA

Typical Mean

effective Acceleration 4.2 m/s²

EMPLOYER'S RESPONSIBILITIES

Employer must enforce compliance with the safety warnings and all other instructions contained in this manual.

Keep this manual available for use by all people assigned to use this tool.

For personal safety and proper operation of this tool, read and understand tool labels and manual. Failure to follow warnings could result in DEATH or SERIOUS INJURY. Read and follow all of these instructions carefully.

FUNCTIONAL DESCRIPTION

Porter-Cable Model FR350A is a heavy duty pneumatic framing nailer. It is designed to install .113" to .148" diameter, plastic collated round head, framing nails of various lengths (2" to 3½"). Fastener collation angle is 22°.

Use approved Porter-Cable fasteners only.

POWER SOURCE

This tool is designed to operate on clean, dry, compressed air at regulated pressures between 70 and 120 PSI (Pounds per Square Inch)(4.8 to 8.3 BAR). The preferred system would include a filter, a pressure regulator, and an automatic oiler located as close to the tool as possible, within 15 ft/4.6 m is ideal.

All compressed air contains moisture and other contaminants that are detrimental to internal components of the tool. An air line filter will remove most of these contaminants and significantly prolong the life of the tool. If an in-line oiler is not available: place five or six drops of Porter-Cable Air Tool Oil into the tool's air inlet at the beginning of each workday.

The tool is equipped with a ¼" male "quick connector". A ⅜" male "quick connector" is available from Porter-Cable and may be used in situations where a ¼" supply line is not available. A ⅜" supply line (and fittings) are required for maximum tool performance. The tool must always be connected to the air supply with a coupling such that all pressure is removed from the tool when the coupling is disconnected.

PREPARING THE TOOL

1. After reading and understanding this entire manual, connect tool to air supply (Fig. 18).

2. Orient a strip of approved fasteners with points down (A) Fig. 19, align, and insert into the magazine "T" slot **points first**.

⚠ WARNING Do not load fastener strip into magazine backwards.

3. Observe fastener icon (A) Fig. 20. Insert fasteners (B) Fig. 20 with points down (C) Fig. 20. Slide fasteners forward to the front of the magazine. The magazine will hold two full strips of fasteners.

IMPORTANT: Fasteners must point in the same direction as they will be driven.

4. Feed the strip of fasteners into the magazine ("T" slot), until they are past the nail stop (A) Fig. 21.

5. Pull the follower (B) Fig. 21A, all the way to the rear of the magazine and allow the follower (C) Fig. 21B to slide forward gently applying pressure to the nail strips to feed the nails into the nail slot of the nose casting. Do not allow the nail pusher to snap forward against the nail strips. This may damage the nail collation and cause the nails to lodge in the nail slot of the nose casting.

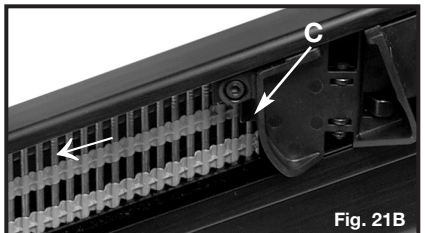
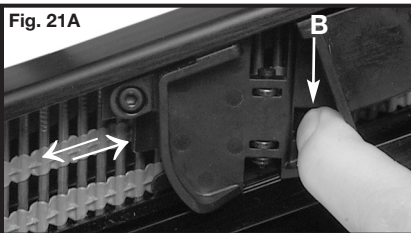
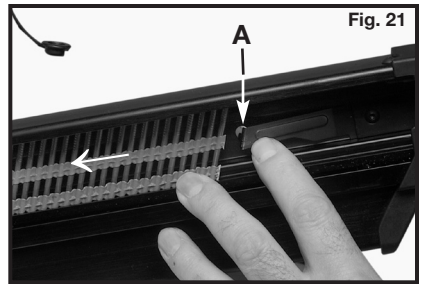
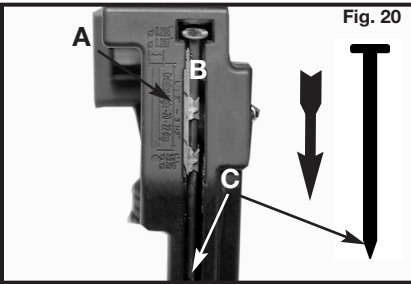
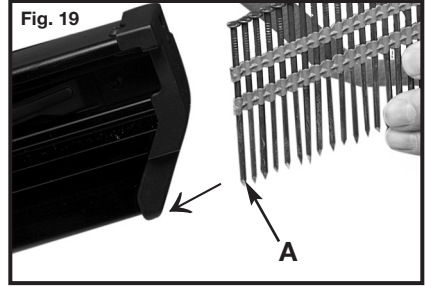
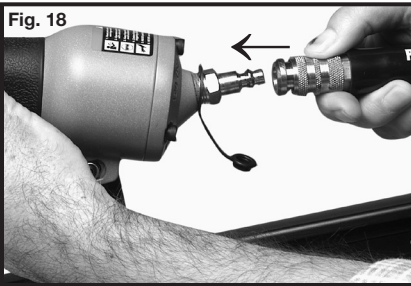

6. Adjust directional exhaust deflector (A) Fig. 22, so that the exhaust air blast will be directed away from the operator. The exhaust deflector provides eight detented positions for directing the exhaust blast away from the operator. Grasp the deflector and rotate it to the desired position for the current application.



OPERATING INSTRUCTIONS

USING THE TOOL WITH SELECTABLE TRIGGERING OPTIONS

Complete all steps of PREPARING THE TOOL before using the tool.

This tool is shipped from the factory with a selectable trigger set in the **“SINGLE SEQUENTIAL ACTUATION”** firing mode as described in number 1 below. The selectable trigger can be set for the **“CONTACT ACTUATION”** firing mode as described in number 2 below;

1. To use the tool in the **SINGLE SEQUENTIAL ACTUATION MODE** depress trigger lever pivot pin (A) Fig. 23, rotate arrow to position (B), and release. **Note:** Trigger lever pivot pin is spring loaded and held in position by locking tab (D) Fig. 23 to prevent movement during operation. To fire, grip tool firmly to maintain control, position nose of tool onto work surface, **push tool firmly against work surface to depress safety, as shown at (S) Fig. 24, and then squeeze trigger to fire a fastener. Allow tool to recoil away from work surface as fastener is driven.** This **“single sequential actuation”** method provides the most accurate fastener placement.

-OR-

2. To use the tool in the **CONTACT ACTUATION MODE** depress trigger lever pivot pin (A) Fig. 23, rotate arrow to position (C), and release. **Note:** Trigger lever pivot pin is spring loaded and held in position by locking tab (D) Fig. 23 to prevent movement during operation. To fire, grip tool firmly to maintain control, **squeeze and hold trigger, push tool firmly against work surface to depress contact safety, as shown at (S) Fig. 24, and fire a fastener. Allow tool to recoil away from work surface as fastener is driven.** If safety element is allowed to recontact work surface before trigger is released an unwanted fastener will be fired. The tool will fire a fastener each time the contact safety is depressed. This method is known as **“contact actuation”** and allows very fast repetitive fastener placement.

IMPORTANT: A trigger, which will limit the tool to **“single sequential actuation”** only, is available free-of-charge by calling 1-800-321-9443 in the United States and Canada or 001-731-660-9374 outside the United States and Canada, and providing tool model number, type, serial number, etc. For identification purposes: the **single sequential actuation** trigger is red.

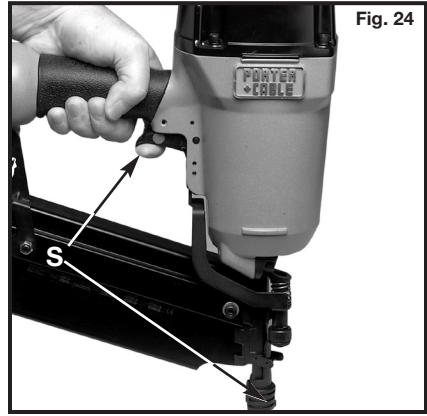
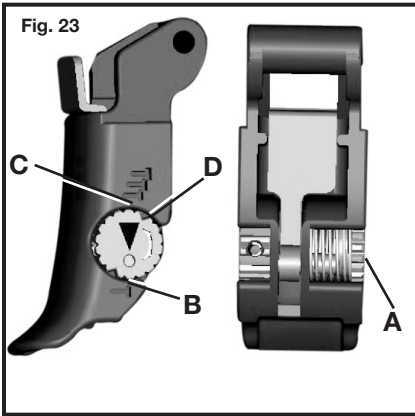

⚠ WARNING Disconnect tool from air supply before performing maintenance, clearing a jammed fastener, leaving work area, moving tool to another location, or handing the tool to another person.

⚠ WARNING Clean and inspect tool daily. Carefully check for proper operation of trigger and safety mechanism. **Do Not** use the tool unless both the trigger and the safety mechanism are functional, or if the tool is leaking air or needs any other repair.

The depth to which a fastener is driven is controlled by the depth adjustment knob (A) Fig. 25. The depth of drive is factory adjusted to a nominal setting. Test fire a fastener and check depth. If a change is desired, rotate the adjustment knob (A) Fig. 25. The adjustment knob has detents every $\frac{1}{4}$ turn. Rotate the knob (A) Fig. 25 clockwise to increase the depth of drive, rotate the knob counterclockwise to decrease the depth of drive. Test fire another fastener and check depth. Repeat as necessary to achieve desired results. The amount of air pressure required will vary depending on the size of the fastener and the material being fastened. Experiment with the air pressure setting to determine the lowest setting that will consistently perform the job at hand. Air pressure in excess of that required can cause premature wear and/or damage to the tool.

A rubber nose cushion (A) Fig. 26 is provided to reduce marring of the work surface. The rubber cushion can be removed, and stored inside the bracket (B) Fig. 27, to provide increased depth-of-drive for toe-nailing applications.

⚠ WARNING Disconnect tool from air supply before removing or re-installing rubber cushion.

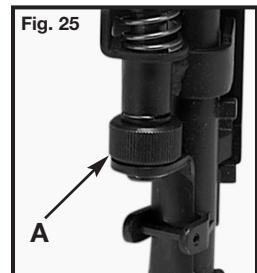

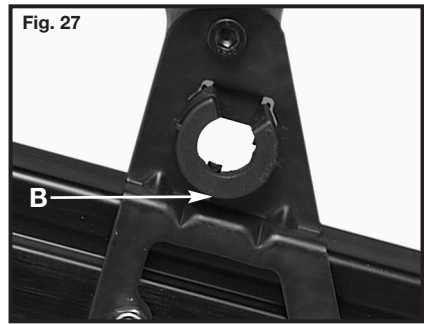
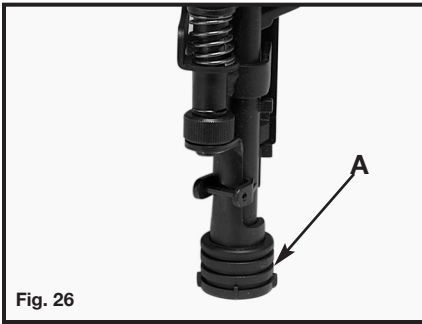

CLEARING A JAMMED FASTENER

⚠ WARNING Disconnect tool from air supply.

1. Remove any remaining fasteners from the nailer.
 - A. Place finger in recess (A) Fig. 28, and depress lever to release follower mechanism.
 - B. With follower release button (A) Fig. 28 depressed, slide follower all the way to the front of the magazine.
 - C. Depress nail stop (B) Fig. 29, slide fasteners to the rear, and remove from magazine (Fig. 29A).

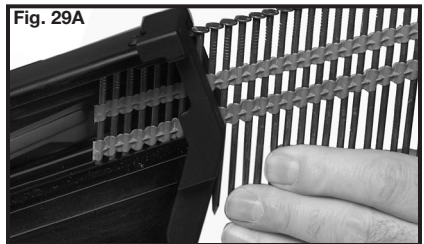
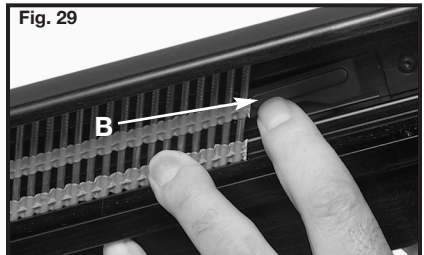
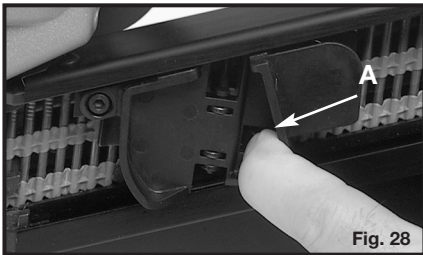

2. If a nail is jammed between the driver and nose casting, the simplest way to remove the jam is to force the driver blade back to the top or start position by using a long approx. 1/4" diameter punch & hammer. The nail is no longer wedged and will either fall free out of the nose or can be extracted using needle nose pliers (A) Fig. 30. If removal of the magazine is required, proceed as follows:
 - A. Remove the two screws (B) Fig. 31.
 - B. Disassemble the magazine.
 - C. After clearing bent fastener, reverse above steps to reassemble.

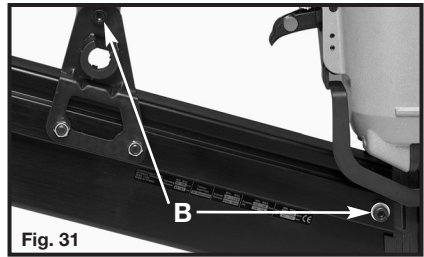
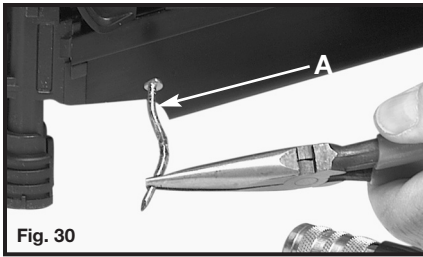

MAINTENANCE

CLEAN AND INSPECT DAILY

⚠ WARNING Disconnect tool from air supply before cleaning and inspection. Correct all problems before placing the tool back in use.

Wipe tool clean and inspect for wear or damage. Use non-flammable cleaning solutions to wipe exterior of tool only if necessary. **DO NOT SOAK** tool with cleaning solutions. Such solutions can damage internal parts.

Inspect trigger and safety mechanism to assure system is complete and functional: no loose or missing parts, no binding or sticking parts.

Keep all screws tight. Loose screws can cause personal injury or damage tool.

If tool is used without an in-line oiler: place 5 or 6 drops of Porter-Cable Air Tool Oil into the air inlet of the tool at the beginning of each workday.

SERVICE AND REPAIRS

All quality tools will eventually require servicing or replacement of parts due to wear from normal use. These operations should **ONLY** be performed by either an **AUTHORIZED PORTER-CABLE SERVICE STATION** or a **PORTER-CABLE•DELTA FACTORY SERVICE CENTER**. All repairs made by these agencies are fully guaranteed against defective material and workmanship. We cannot guarantee repairs made or attempted by anyone other than these agencies.

Should you have any questions about your tool, feel free to write us at any time. In any communications, please give all information shown on the nameplate of your tool (model number, type, serial number, etc.).

TROUBLESHOOTING

▲WARNING Disconnect tool from air supply before performing any Service Procedure.

SYMPTOM	PROBLEMS	SOLUTIONS
1. Air leak near top of tool or in trigger area.	Loose screws. Worn or damaged o-rings or seals.	Tighten screws. Install Overhaul Kit.
2. Tool does nothing or operates sluggishly.	Inadequate air supply. Inadequate lubrication. Worn or damaged o-rings or seals.	Verify adequate air supply. Put 5 or 6 drops of oil into air inlet. Install Overhaul Kit.
3. Air leak near bottom of tool.	Loose screws. Worn or damaged o-rings or bumper.	Tighten screws. Install Overhaul Kit.
4. Tool jams frequently.	Incorrect fasteners. Damaged fasteners. Magazine or nose screws loose. Magazine is dirty. Driver is worn or damaged.	Verify approved fasteners of correct size. Replace w/undamaged fasteners. Tighten screws. Clean magazine. Install "DRIVER" Maintenance Kit.
5. Other.		Contact a Porter-Cable Service Facility.

ACCESSORIES

A complete line of accessories is available from your Porter-Cable • Delta Supplier, Porter-Cable • Delta Factory Service Centers, and Porter-Cable Authorized Service Stations. Please visit our Web Site www.porter-cable.com for a catalog or for the name of your nearest supplier.

▲WARNING Since accessories, other than those offered by Porter-Cable • Delta, have not been tested with this product, use of such accessories could be hazardous. For safest operation, only Porter-Cable • Delta recommended accessories should be used with this product.

PORTER-CABLE LIMITED ONE YEAR WARRANTY

Porter-Cable warrants its nailing and stapling tools for a period of one year from the date of original purchase. We will repair or replace at our option, any part or parts of the product and accessories covered under this warranty which, after examination, proves to be defective in workmanship or material during the warranty period. For repair or replacement return the complete tool or accessory, transportation prepaid, to your nearest Porter-Cable Service Center or Authorized Service Station. Proof of purchase may be required. This warranty does not apply to O-rings and Driver Blades or to repair or replacement required due to misuse, abuse, normal wear and tear or repairs attempted or made by other than our Service Centers or Authorized Service Stations.

ANY IMPLIED WARRANTY, INCLUDING THE IMPLIED WARRANTIES OF MERCHANTABILITY AND FITNESS FOR A PARTICULAR PURPOSE, WILL LAST ONLY FOR ONE (1) YEAR FROM THE DATE OF PURCHASE.

To obtain information on warranty performance please write to: PORTER-CABLE CORPORATION, 4825 Highway 45 North, Jackson, Tennessee 38305; Attention: Product Service. THE FOREGOING OBLIGATION IS PORTER-CABLE'S SOLE LIABILITY UNDER THIS OR ANY IMPLIED WARRANTY AND UNDER NO CIRCUMSTANCES SHALL PORTER-CABLE BE LIABLE FOR ANY INCIDENTAL OR CONSEQUENTIAL DAMAGES. Some states do not allow limitations on how long an implied warranty lasts or the exclusion or limitation of incidental or consequential damages, so the above limitation or exclusion may not apply to you.

This warranty gives you specific legal rights and you may also have other legal rights which vary from state to state.

PORTER-CABLE • DELTA SERVICE CENTERS (CENTROS DE SERVICIO DE PORTER-CABLE • DELTA) (CENTRE DE SERVICE PORTER-CABLE • DELTA)

**Parts and Repair Service for Porter-Cable • Delta Power Tools are Available at These Locations
(Obtenga Refaccion de Partes o Servicio para su Herramienta en los Siguietes Centros de Porter-Cable • Delta)
(Locations où vous trouverez les pièces de rechange nécessaires ainsi qu'un service d'entretien)**

ARIZONA

Tempe 85282 (Phoenix)
2400 West Southern Avenue
Suite 105
Phone: (602) 437-1200
Fax: (602) 437-2200

CALIFORNIA

Ontario 91761 (Los Angeles)
3949A East Guasti Road
Phone: (909) 390-5555
Fax: (909) 390-5554
San Leandro 94577 (Oakland)
3039 Teagarden Street
Phone: (510) 357-9762
Fax: (510) 357-7939

COLORADO

Arvada 80003 (Denver)
8175 Sheridan Blvd., Unit S
Phone: (303) 487-1809
Fax: (303) 487-1668

FLORIDA

Davie 33314 (Miami)
4343 South State Rd. 7 (441)
Unit #107
Phone: (954) 321-6635
Fax: (954) 321-6638
Tampa 33609
4538 W. Kennedy Boulevard
Phone: (813) 877-9585
Fax: (813) 289-7948

GEORGIA

Forest Park 30297 (Atlanta)
5442 Frontage Road,
Suite 112
Phone: (404) 608-0006
Fax: (404) 608-1123

ILLINOIS

Adoniss 60101 (Chicago)
400 South Rohlwing Rd.
Phone: (630) 424-8805
Fax: (630) 424-8895

WOODRIDGE 60517 (Chicago)

2033 West 75th Street
Phone: (630) 910-9200
Fax: (630) 910-0360

MARYLAND

Elkridge 21075 (Baltimore)
7397-102 Washington Blvd.
Phone: (410) 799-9394
Fax: (410) 799-9398

MASSACHUSETTS

Braintree 02185 (Boston)
719 Granite Street
Phone: (781) 848-9810
Fax: (781) 848-6759

FRANKLIN 02038 (Boston)

Franklin Industrial Park
101E Constitution Blvd.
Phone: (508) 520-8802
Fax: (508) 528-8089

MICHIGAN

Madison Heights 48071 (Detroit)
30475 Stephenson Highway
Phone: (248) 597-5029
Fax: (248) 597-5004

MINNESOTA

Minneapolis 55429
5522 Lakeland Avenue North
Phone: (763) 561-9080
Fax: (763) 561-0653

MISSOURI

North Kansas City 64116
1141 Swift Avenue
Phone: (816) 221-2070
Fax: (816) 221-2897

ST. LOUIS 63119

7574 Watson Road
Phone: (314) 968-8950
Fax: (314) 968-2790

NEW YORK

Flushing 11365-1595 (N.Y.C.)
175-25 Horace Harding Expwy.
Phone: (718) 225-2040
Fax: (718) 423-9619

NORTH CAROLINA

Charlotte 28270
9129 Monroe Road, Suite 115
Phone: (704) 841-1102
Fax: (704) 708-4625

OHIO

Columbus 43214
4560 Indianola Avenue
Phone: (614) 263-0092
Fax: (614) 263-1238

CLEVELAND 44125

8001 Sweet Valley Drive
Unit #19
Phone: (216) 447-9030
Fax: (216) 447-3097

OREGON

Portland 97230
4916 NE 122 nd Ave.
Phone: (503) 252-0107
Fax: (503) 252-2123

PENNSYLVANIA

Willow Grove 19090
520 North York Road
Phone: (215) 658-1430
Fax: (215) 658-1433

TEXAS

Carrollton 75006 (Dallas)
1300 Interstate 35 N, Suite 112
Phone: (972) 446-2996
Fax: (972) 446-8157

HOUSTON 77055

West 10 Business Center
1008 Wirt Road, Suite 120
Phone: (713) 682-0334
Fax: (713) 682-4867

WASHINGTON

Auburn 98001 (Seattle)
3320 West Valley HWY, North
Building D, Suite 111
Phone: (253) 333-8353
Fax: (253) 333-9613

Authorized Service Stations are located in many large cities. Telephone **800-487-8665** or **731-541-6042** for assistance locating one. Parts and accessories for Porter-Cable • Delta products should be obtained by contacting any Porter-Cable • Delta Distributor, Authorized Service Center, or Porter-Cable • Delta Factory Service Center. If you do not have access to any of these, call **888-848-5175** and you will be directed to the nearest Porter-Cable • Delta Factory Service Center. Las Estaciones de Servicio Autorizadas están ubicadas en muchas grandes ciudades. Llame al **800-487-8665** ó al **731-541-6042** para obtener asistencia a fin de localizar una. Las piezas y los accesorios para los productos Porter-Cable • Delta deben obtenerse poniéndose en contacto con cualquier distribuidor Porter-Cable • Delta, Centro de Servicio Autorizado o Centro de Servicio de Fábrica Porter-Cable • Delta. Si no tiene acceso a ninguna de estas opciones, llame al **888-848-5175** y le dirijirán al Centro de Servicio de Fábrica Porter-Cable • Delta más cercano. Des centres de service agréés sont situés dans beaucoup de grandes villes. Appelez au **800-487-8665** ou au **731-541-6042** pour obtenir de l'aide pour en repérer un. Pour obtenir des pièces et accessoires pour les produits Porter-Cable • Delta, s'adresser à tout distributeur Porter-Cable • Delta, centre de service agréé ou centre de service d'usine Porter-Cable • Delta. Si vous n'avez accès à aucun de ces centres, appeler le **888-848-5175** et on vous dirigera vers le centre de service d'usine Porter-Cable • Delta le plus proche.

CANADIAN PORTER-CABLE • DELTA SERVICE CENTERS

ALBERTA

Bay 6, 2520-23rd St. N.E.
Calgary, Alberta
T2E 8L2
Phone: (403) 735-6166
Fax: (403) 735-6144

BRITISH COLUMBIA

8520 Baxter Place
Burnaby, B.C.
V5A 4T8
Phone: (604) 420-0102
Fax: (604) 420-3522

MANITOBA

1699 Dublin Avenue
Winnipeg, Manitoba
R3H 0H2
Phone: (204) 633-9259
Fax: (204) 632-1976

ONTARIO

505 Southgate Drive
Guelph, Ontario
N1H 6M7
Phone: (519) 836-2840
Fax: (519) 767-4131

QUÉBEC

1515 Ave.
St-Jean Baptiste,
Québec, Québec
G2E 5E2
Phone: (418) 877-7112
Fax: (418) 877-7123

1447, Begin
St-Laurent, (Montréal), Québec
H4R 1V8
Phone: (514) 336-8772
Fax: (514) 336-3505

The following are trademarks of PORTER-CABLE • DELTA (Las siguientes son marcas registradas de PORTER-CABLE • DELTA S.A.) (Les marques suivantes sont des marques de fabricant de la PORTER-CABLE • DELTA): Auto-Set®, BAMMER®, B.O.S.S.®, Builder's Saw®, Contractor's Saw®, Contractor's Saw II™, Delta®, DELTACRAFT®, DELTAGRAM™, Delta Series 2000™, DURATRONIC™, Emc2™, FLEX®, Flying Chips™, FRAME SAW®, Homecraft®, INNOVATION THAT WORKS®, Jet-Lock®, JETSTAMP®, kickstand®, LASERLOC®, MICRO-SET®, Micro-Set®, MIDI LATHE®, MORTEN™, NETWORK™, OMNIJUG®, POCKET CUTTER®, PORTA-BAND®, PORTA-PLANE®, PORTER-CABLE®(design), PORTER-CABLE® PROFESSIONAL POWER TOOLS, Posi-Matic®, Q-3®(design), QUICKSAND®(design), QUICKSET™, QUICKSET II®, QUICKSET PLUS™, RIPTIDE™(design), SAFE GUARD II®, SAFE-LOC®, Sanding Center®, SANDTRAP®(design), SAW BOSS®, Sawbuck™, Sidekick®, SPEED-BLOC®, SPEEDMATIC®, SPEEDTRONIC®, STAIR EASE®, The American Woodshop®(design), The Lumber Company®(design), THE PROFESSIONAL EDGE®, THE PROFESSIONAL SELECT®, THIN-LINE™, TIGER®, TIGER CUB®, TIGER SAW®, TORQBUSTER®, TORQ-BUSTER®, TRU-MATCH™, TWIN-LITE™, UNIGUARD®, Unifence®, UNIFEEDER™, Unihead®, Uniplane™, Unirip®, Unisaw®, Unisive®, Versa-Feeder®, VERSA-PLANE®, WHISPER SERIES®, WOODWORKER'S CHOICE™.

Trademarks noted with ™ and ® are registered in the United States Patent and Trademark Office and may also be registered in other countries. Las Marcas Registradas con el signo de ™ y ® son registradas por la Oficina de Registros y Patentes de los Estados Unidos y también pueden estar registradas en otros países. Marques déposées, indiquées par la lettre ™ et ®, sont déposées au Bureau des brevets d'invention et marques déposées aux Etats-Unis et pourraient être déposées aux autres pays. Printed in U.S.A. PC-0303-151