

OWNER'S MANUAL Cat. No. 21-1620

TRC-235

2 Watt 3-Channel CB Walkie-Talkie

Please read before using this equipment.

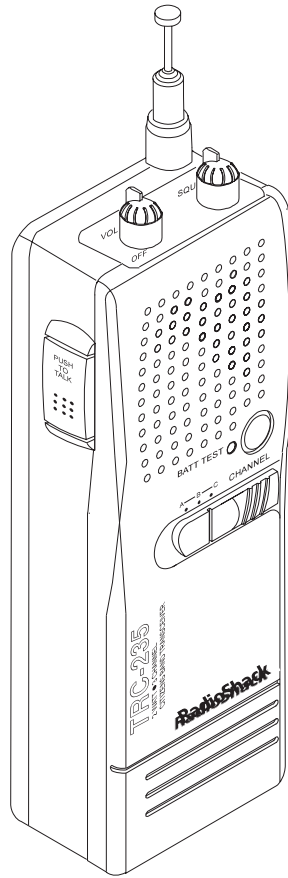

RadioShack®



FEATURES



Your RadioShack TRC-235 2 Watt 3-Channel CB Walkie-Talkie is a portable, two-way radio you can carry almost anywhere. You can use your TRC-235 around the house, in your office, or in your car or boat. You can also use it on fishing and camping trips, or at your business for supervisory, security, or warehouse personnel.

Your TRC-235 has the following features:

Factory-Installed Crystals — let you immediately begin using your TRC-235 on Channel 14.

Three-Channel Operation — comes with Channel 14 crystals installed, but lets you install optional crystals so you can operate the TRC-235 on any two of the other 39 available CB channels. (See "Adding Crystals" on Page 24).

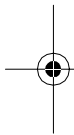

Built-In Modulation Limiter Circuit — automatically adjusts to a variety of voice levels to ensure a clear transmission.

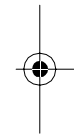

Crystal-Controlled Circuitry — provides accurate and stable channel selection.

Adjustable Squelch — helps to eliminate noise between transmissions.

Telescoping Antenna — provides excellent reception and transmission.

External Antenna Jack — lets you connect an external antenna (not supplied) to your TRC-235 for mobile or base-station use, or to extend the TRC-235's range.

Battery Test Button and Battery Indicator — lets you check the batteries' condition.

© 1997 Tandy Corporation.
All Rights Reserved.
RadioShack is a registered trademark
used by Tandy Corporation.

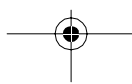

Power/Charging Jack — lets you power your TRC-235 from an AC or DC power source, so you can use the TRC-235 without draining the batteries. And, lets you charge nickel-cadmium batteries without removing them from the TRC-235.

Note: You need eight AA alkaline batteries or ten nickel-cadmium rechargeable batteries (not supplied) to power your TRC-235.

We recommend you record the TRC-235's serial number here. The serial number is located on the radio's back panel:

FCC INFORMATION

The Federal Communications Commission (FCC) does not require you to have a license to operate this walkie-talkie. However, the FCC does require that you read and know Part 95 of *FCC Rules*. These rules apply to the operation of a Class D CB. We have provided a copy of these regulations with your TRC-235.

Internal adjustments and/or modifications can lead to illegal operation as defined by Part 95 of *FCC Rules*. Such illegal operation can lead to very serious consequences.

To be safe and sure:

- Never open your TRC-235's case except to install or change crystals.
- Never modify your TRC-235.



Your TRC-235 might cause TV or radio interference even when it is operating properly. To determine whether your TRC-235 is causing the interference, turn off your TRC-235. If the interference goes away, your TRC-235 is causing it. Try to eliminate the interference by:

- Moving your TRC-235 away from the TV or radio
- Contacting your local RadioShack store for help

Warning: Do not open your TRC-235 to make any internal adjustments other than installing or changing crystals. Any internal adjustments should be made only by authorized service personnel.

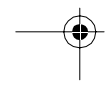
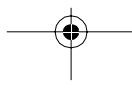
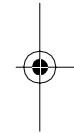
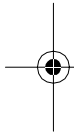



CONTENTS

- Powering the CB 6**
 - Using the POWER Jack and ALKALINE/NI-CD Switch..... 6
 - Using Batteries 7
 - Testing the Battery Power 10
 - Recharging Nickel-Cadmium Batteries 10
 - Using Vehicle Battery Power 12
 - Using AC Power 13
- External Antenna 15**
- Operation 17**
 - Receiving Transmissions and Adjusting Squelch 17
 - Transmitting 19
- CB Operation Tips 20**
 - Common Uses for a CB Radio 20
 - Business Uses 20
 - Personal Uses 20
 - Using Common 10-Codes 21
 - CB Courtesy 23
 - Maximum Range 23
- Adding Crystals 24**
- Troubleshooting 28**
- Maintenance 29**
- Specifications 30**

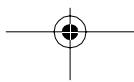
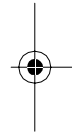

POWERING THE CB

You can power your TRC-235 from any of these sources:

- Eight AA alkaline batteries (not supplied) with two dummy batteries (supplied)
- Ten rechargeable AA nickel-cadmium batteries (not supplied)
- 12-volt vehicle battery power using a fused power cord (not supplied)
- Standard AC power using a power supply (not supplied)

USING THE POWER JACK AND ALKALINE/NI-CD SWITCH

The **POWER** jack lets you connect an external power source (such as your vehicle's battery power or AC power) to power the TRC-235, or connect a battery charger to charge nickel-cadmium batteries while they are in the TRC-235.

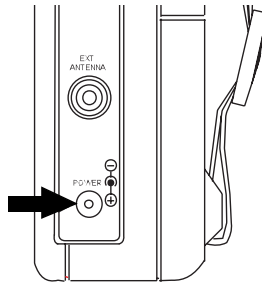

The TRC-235 also has a slide switch (**ALKALINE/NI-CD**) inside the battery compartment which you must set correctly, depending on what power source you are using and whether or not you want to charge rechargeable batteries while they are in the TRC-235.

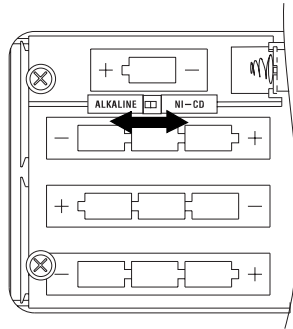

- Set it to **ALKALINE** before you connect an external power source (vehicle battery power or AC adapter) to the **POWER** jack or while you are using internal batteries (alkaline or rechargeable).
- Set it to **NI-CD** *only* when you are connecting a battery charger in order to charge the installed rechargeable batteries. Be sure you set it to **NI-CD** *before* you connect a battery charger to the **POWER** jack.

Warning: To avoid injuring yourself or damaging the TRC-235, connect a battery charger to the **POWER** jack *only* when nickel-cadmium batteries are installed (see "Recharging Nickel-Cadmium Batteries" on Page 10). Never try to recharge non-rechargeable batteries. They could get very hot and explode.

Note: You can connect an external power source regardless of the type of batteries you installed.

USING BATTERIES

You can power the TRC-235 from eight AA alkaline batteries (such as RadioShack Cat. No. 23-552) with the two supplied dummy batteries, or ten rechargeable AA nickel-cadmium batteries (such as Cat. No. 23-125).

Cautions:

- Always use fresh, or freshly charged, batteries of the required size and type.
- Do not mix old and new batteries, different types of batteries (standard, alkaline, or rechargeable nickel-cadmium), or rechargeable batteries of different capacities.

Follow these steps to install the batteries.

1. If the TRC-235 is on, turn **OFF/VOLUME** fully counterclockwise until it clicks to turn it off.

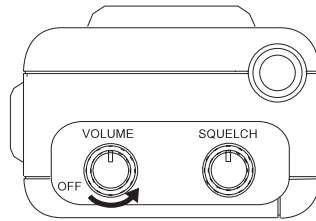

2. Slide the strap on the back of the TRC-235 through the buckle and the battery compartment cover to remove it.

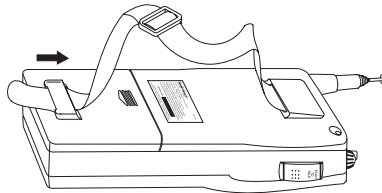

3. Slide the battery compartment cover in the direction of the arrow to remove it.

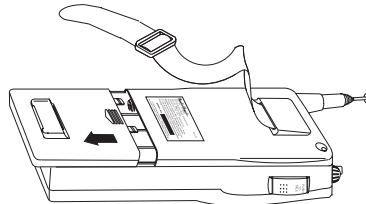

4. Be sure **ALKALINE/NI-CD** inside the battery compartment is set to **ALKALINE**.
5. Put eight AA alkaline batteries and the two supplied dummy batteries, or ten AA nickel-cadmium batteries into the battery compartment, as indicated by the polarity symbols (+ and -) marked inside.

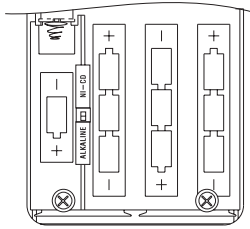

Note: Before you use the TRC-235 with nickel-cadmium batteries, you need to charge the batteries (see "Recharging Nickel-Cadmium Batteries" on Page 10).

6. Replace the battery compartment cover and the strap on the back of the TRC-235.

Cautions:

- If you will not be using the TRC-235 from battery power for several months, remove the batteries.
- Dispose of old batteries promptly and properly.

Testing the Battery Power

1. Turn on the TRC-235 by rotating **OFF/VOLUME** clockwise until it clicks.
2. Hold down **BATT TEST**. If the indicator lights, there is enough battery power to operate the CB. If the indicator is dim or does not light, replace or recharge the batteries.

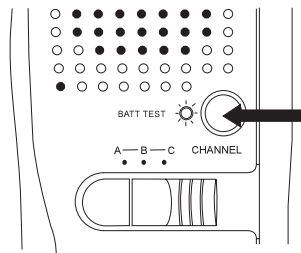

Recharging Nickel-Cadmium Batteries

You can use a battery charger, such as Cat. No. 23-249 (not supplied), to charge or recharge nickel-cadmium batteries while they are inside the TRC-235's battery compartment.

Do not use the TRC-235 while you are charging the nickel-cadmium batteries.

Cautions:

- Use only the recommended battery charger to recharge the batteries in the TRC-235. Other chargers could damage your TRC-235 or the batteries.
- Be careful not to overcharge nickel-cadmium batteries.
- To prevent damage to rechargeable nickel-cadmium batteries, never charge them in an area where the temperature is above 90°F (32°C) or below 40°F (4.5°C).

Follow these steps to charge nickel-cadmium batteries in the TRC-235.

1. If the TRC-235 is on, turn **OFF/VOLUME** fully counterclockwise until it clicks to turn it off.

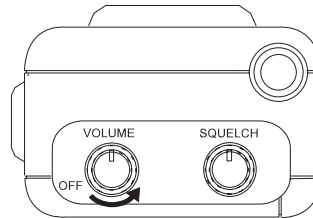

2. Set **ALKALINE/NI-CD** inside the battery compartment to **NI-CD** (see "Using the Power Jack and Alkaline/NI-CD Switch" on Page 6).
3. Connect the battery charger's barrel plug to the **POWER** jack on the side of the TRC-235, then plug the battery charger's plug into a standard AC outlet.

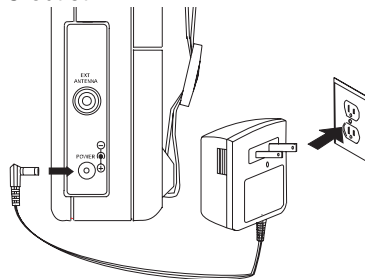

It takes about 20 hours to charge new or fully discharged nickel-cadmium batteries. Subsequent charges take about 14 to 16 hours.

-
4. When charging is complete, unplug the battery charger's plug from the AC outlet. Then, disconnect the battery charger's barrel plug from the **POWER** jack.

Note: You can use an external charger (such as Cat. No. 23-134, not supplied) to recharge the nickel-cadmium batteries. After removing the batteries from the TRC-235, follow the instructions that come with the external charger.

Important: Your TRC-235 is capable of using nickel-cadmium batteries. At the end of the batteries' useful life, they must be recycled or disposed of properly. Contact your local, county, or state hazardous waste management authorities for information on recycling or disposal programs in your area. Some options that might be available are: municipal curbside collection, drop-off boxes at retailers such as your local RadioShack store, recycling collection centers, and mail-back programs.

USING VEHICLE BATTERY POWER

You can power your TRC-235 from your vehicle's cigarette-lighter socket with an optional 12-volt DC fused power cord (such as Cat. No. 270-1533).

- You must use a DC fused cord that supplies 12 volts and delivers at least 1000 milliamps of vehicle power. Its center tip must be set to positive, and its plug must correctly fit the TRC-235's **POWER** jack. The recommended fused cord meets these specifications. Using a fused cord that does not meet these specifications could damage the TRC-235 or the fused cord.

-
- When you finish using the TRC-235, unplug the fused cord from the cigarette-lighter socket before you disconnect it from your TRC-235.
1. If the TRC-235 is on, turn **OFF/VOLUME** fully counterclockwise until it clicks to turn it off.
 2. Be sure **ALKALINE/NI-CD** inside the battery compartment is set to **ALKALINE**.
 3. Insert the power cord's 5.5 mm outer diameter/2.1 mm inner diameter barrel plug into the **POWER** jack.
 4. Plug the power cord's other end into your vehicle's cigarette-lighter socket.

Note: If the TRC-235 does not operate when you use the DC power cord, unplug the cord from the cigarette-lighter socket and clean any ashes or debris from the socket. If your TRC-235 still does not work, check the fuse in the DC power cord and replace it if necessary.

USING AC POWER

You can power your TRC-235 from standard AC power using an optional 12-volt AC adapter that provides 1 amp, such as RadioShack Cat. No. 273-1653.

Cautions:

- The adapter must be able to deliver 12 volts and at least 1 amp, its center tip must be set to positive, and the barrel plug must correctly fit the TRC-235's **POWER** jack. The recommended adapter meets these specifications. Using an adapter that does not meet these specifications could damage the TRC-235 or the adapter.



- To help prevent an electrical short, unplug the adapter from the AC outlet before you unplug the adapter from the TRC-235.

Follow these steps to connect the TRC-235 to AC power.

1. Connect the adapter's 5.5 mm outer diameter/2.1 mm inner diameter barrel plug to the adapter's cord, setting TIP to + (positive)
2. Be sure **ALKALINE/NI-CD** inside the battery compartment is set to **ALKALINE**.
3. Connect the adapter's barrel plug to the TRC-235's **POWER** jack.
4. Plug the other end of the adapter into a standard AC outlet.

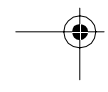
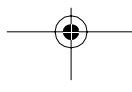
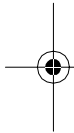



EXTERNAL ANTENNA



Your walkie-talkie comes with a telescoping antenna that is ideal for most applications. However, the walkie-talkie's **EXT ANTENNA** jack makes it easy to connect other types of antennas, too. For mobile or base station use, you might want to connect an optional external antenna. Your local RadioShack store carries a wide selection of external mobile or outdoor base-station antennas. Choose the one that best meets your needs.

When deciding on a mobile or base-station antenna and its location, consider the following:

- The location of the antenna should be as high as possible.
- The antenna and antenna cable should be as far as possible from sources of electrical noise (appliances, other radios, and so on).
- The antenna should be vertical for the best performance.

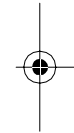
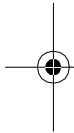

Notes:

- When connecting an optional antenna, always use 50-ohm coaxial cable, such as RG-58 or RG-8. For lengths over 50 feet, use RG-8 low-loss dielectric coaxial cable. If the coaxial cable's connector does not fit into the **EXT ANTENNA** jack, you might also need a PL-259-to-phono antenna plug adapter, such as Cat. No. 278-208. Your local RadioShack store carries a wide variety of coaxial antenna cable and connectors.

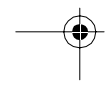
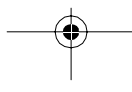

- For the best performance when you use an external antenna, do not extend the TRC-235's telescoping antenna.

Follow the installation instructions supplied with the antenna, route the antenna cable to the TRC-235, then connect it to the **EXT ANTENNA** jack.

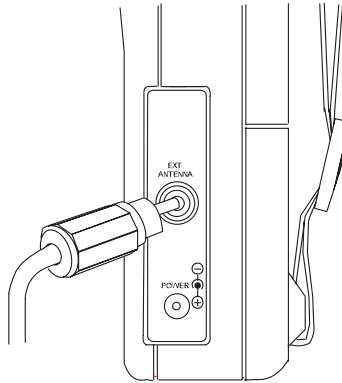

Cautions:

- Do not run the cable over sharp edges or moving parts.
- Do not run the cable next to power cables or other CB antenna cables.
- Do not run the cable through a vehicle's engine compartment or other areas that produce extreme heat.
- Follow all cautions and warnings included with the antenna.

Warning: When installing or removing a base station CB antenna, use extreme caution. If the antenna starts to fall, let it go! It could contact overhead power lines. If the antenna touches the power line, contact with the antenna, mast, cable or guy wires can cause electrocution and death! Call the power company to remove the antenna. **DO NOT** attempt to do so yourself.

OPERATION

Before you use your TRC-235, we recommend you read "CB Operation Tips" on Page 20, which contains information to help you use it effectively and courteously.

RECEIVING TRANSMISSIONS AND ADJUSTING SQUELCH

1. If you did not connect an external antenna, fully extend the TRC-235's telescoping antenna and hold the TRC-235 so the antenna is vertical.

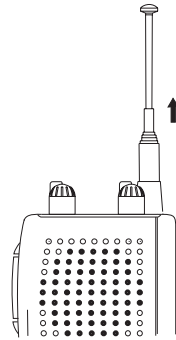

Caution: Unless an external antenna is attached, you should fully extend the antenna for maximum efficiency.

2. Set **CHANNEL** to **A**, **B**, or **C**.

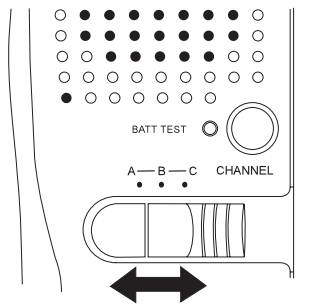

Note: Your TRC-235 comes with Channel 14 crystals installed in channel position A. To use other channels, you must first install crystals in channel positions B and C inside the TRC-235 (see "Adding Crystals" on Page 24).

3. Turn on the TRC-235 by turning **OFF/VOLUME** clockwise until you hear a click and a hissing sound.

Note: You might not hear a hissing sound if **CHANNEL** is set to **B** or **C** and you haven't installed any crystals in channel positions B or C.

4. Adjust **OFF/VOLUME** to a comfortable listening level.
5. Adjust **SQUELCH** to cut out the background noise. To do this, wait until there is no signal on the channel. Then slowly turn **SQUELCH** clockwise until the background noise stops.

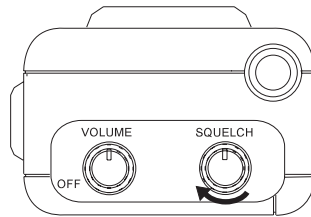

Note: Do not turn **SQUELCH** too far clockwise because you might also cut out weak signals.

6. To turn off the TRC-235, turn **OFF/VOLUME** toward **OFF** until it clicks.

TRANSMITTING

1. Follow Steps 1–5 in “Receiving Transmissions and Adjusting Squelch” on Page 17.
2. Hold the TRC-235 2 to 3 inches from your mouth. Hold down **PUSH TO TALK** on the side of the TRC-235 and speak in a normal voice into the microphone.

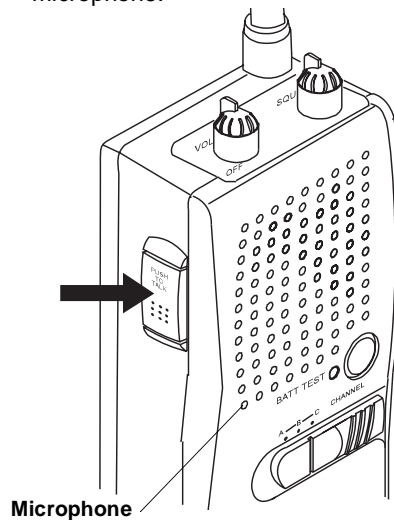

When you finish speaking, release the button.

Note: Do not speak too loudly when transmitting. It does not make your signal any stronger, and might distort your transmission.

Important: Channel 9 is reserved for motorist assistance and for reporting emergency information about accidents, hazardous road conditions, and so on. If you have installed the necessary crystals in your TRC-235 and you are using Channel 9, always give emergency messages priority.

3. To turn off the TRC-235, turn **OFF/ VOLUME** toward **OFF** until it clicks.



CB OPERATION TIPS



The following tips will help you get the most enjoyment from your TRC-235.

COMMON USES FOR A CB RADIO

Business Uses

- Truck drivers and delivery personnel can learn road and traffic conditions and get assistance in locating destinations. A walkie-talkie is also good company on those “long hauls.”
- On construction crews, a walkie-talkie quickly pays for itself when you are calling for additional materials or coordinating the activities of different work crews.
- For security officers, a walkie-talkie is more than a convenience — it is a must for both safety and efficiency.

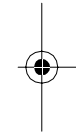
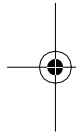

Personal Uses

- Keep in touch with home while driving to work, to the store, or to a social activity. Let your family know you are tied up in traffic or that you will stop by the store on the way home.
- If you are a two-car (or more) family, walkie-talkies are great for communicating with family members while they are in their cars.
- Contact friends or neighbors — find out “what’s happening” or plan a get-together.
- Ever have car trouble or run out of gas on the highway? What an assurance it is to be able to radio for assistance.

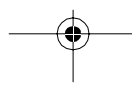

- Camping, fishing, and other sports are more fun with a walkie-talkie. Locate a friend or find out "what's cooking" back at camp.

USING COMMON 10-CODES

Citizen's band operators have largely adopted the 10-codes for standard questions and answers. Their use permits faster communication and better intelligibility in noisy areas.

This table lists the codes adopted by the Associated Public Safety Communications Officers (APCO).

Code	Meaning
10-1	Cannot understand your message.
10-2	Your signal is good.
10-3	Stop transmitting.
10-4	Message received and understood.
10-5	Relay information to _____.
10-6	I am busy.
10-7	Out of service.
10-8	In service.
10-9	Repeat last message.
10-10	Negative (No).
10-11	_____ in service.
10-12	Stand by.
10-13	Report _____ conditions.
10-14	Information.

Code	Meaning
10-15	Message delivered.
10-16	Reply to message.
10-17	En route.
10-18	Urgent.
10-19	Contact _____.
10-20	My location is _____.
10-21	Call _____ by telephone.
10-22	Cancel last message.
10-23	Arrived at the scene.
10-24	Assignment complete.
10-26	Estimated time of arrival is ____.
10-30	Use caution.
10-31	Pick up.
10-33	Emergency traffic. Clear the channel.
10-34	The time is ____.

Note: Although this table lists the 10-codes' meanings in the form of a statement, they can also be phrased as questions (10-6: Are you busy?, 10-20: What is your location?).



CB COURTESY

- Wait for a pause in someone else's transmission before you ask for a break.
- If you do not receive an answer to your call after a second attempt, sign off and wait several minutes before trying again.
- Do not hold down **PUSH TO TALK** when you are not talking. (This is called *dead keying*.)
- Assist callers with directions, information about road conditions, and any other reasonable requests.

MAXIMUM RANGE

The maximum range and quality of CB transmissions vary depending on these conditions:

- Amount of power in the batteries
- The surrounding terrain — mountains and tall buildings limit the range
- Weather conditions
- The number of nearby CBs operating on the same channel

To ensure maximum range, always keep fresh alkaline batteries or fully charged nickel-cadmium batteries in your TRC-235 when using battery power.

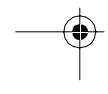
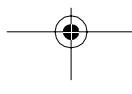

ADDING CRYSTALS

Your TRC-235 includes two crystals (transmit and receive) installed in channel position A. The crystals let you use the CB on channel 14. You can add two more crystals in channel positions B and C so you can use any two other channels of the 40 allotted to CBs. However, you must use only crystals specifically designed for the TRC-235, available from your local RadioShack store. Be sure to specify the channel you want and the TRC-235's catalog number (Cat. No. 21-1620).

Note: Channel A crystals are soldered in, and can be replaced only by a qualified technician.

The following chart shows the frequency pairs (in MHz) for receiving and transmitting on each CB channel.

Note: Receive crystals use a frequency 455 kHz lower than transmit crystals.

Channel	Transmit	Receive
1	26.965	26.510
2	26.975	26.520
3	26.985	26.530
4	27.005	26.550
5	27.015	26.560
6	27.025	26.570
7	27.035	26.580
8	27.055	26.600
9	27.065	26.610
10	27.075	26.620
11	27.085	26.630
12	27.105	26.650
13	27.115	26.660
14	27.125	26.670
15	27.135	26.680

Channel	Transmit	Receive
16	27.155	26.700
17	27.165	26.710
18	27.175	26.720
19	27.185	26.730
20	27.205	26.750
21	27.215	26.760
22	27.225	26.770
23	27.255	26.800
24	27.235	26.780
25	27.245	26.790
26	27.265	26.810
27	27.275	26.820
28	27.285	26.830
29	27.295	26.840
30	27.305	26.850
31	27.315	26.860
32	27.325	26.870
33	27.335	26.880
34	27.345	26.890
35	27.355	26.900
36	27.365	26.910
37	27.375	26.920
38	27.385	26.930
39	27.395	26.940
40	27.405	26.950

Note: A crystal is marked with its frequency.

Follow these steps to change or install crystals in your TRC-235.

1. If the TRC-235 is on, turn **OFF/VOLUME** fully counterclockwise until it clicks to turn it off.
2. Remove the batteries (if installed).

3. Set **CHANNEL** to **A**, slide your thumb under the right edge of **CHANNEL**, then *carefully* pull **CHANNEL** up to remove it.

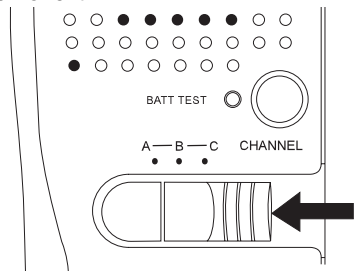

4. Use a Phillips screwdriver to remove the back cover's three screws.

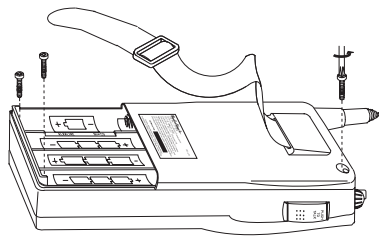

Caution: The **BATT TEST** button might come off of the front of the TRC-235 when you remove the front cover. If this happens, simply replace it.

5. Firmly grasp the TRC-235's front and back cover's sides and *carefully* pull the front cover away from the back cover.

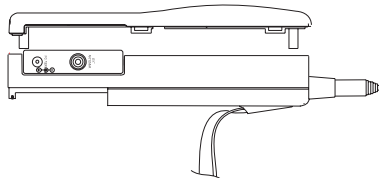

6. Insert a new matched pair of crystals (send and receive) into the sockets for Channel B or C.

The sockets for the crystals are marked next to Channel A on the circuit board with X1 (receive) and X2 (transmit). The channel's letter (A, B, or C) is marked on the circuit board and on the diagram below.

Important: Be sure you install the receive (R) and transmit (T) crystals in their correct sockets. Do not reverse the transmit and receive crystals. If you do, the TRC-235 will transmit and receive on frequencies outside the citizen's band, resulting in illegal operation.

(some circuitry details left out for clarity)

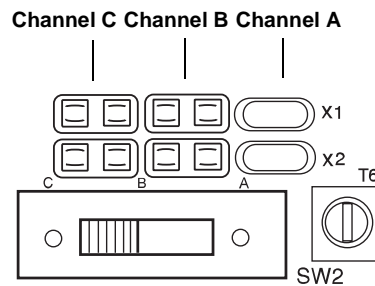

7. When you have finished installing new crystals, carefully fit the TRC-235's front cover to the back cover and gently squeeze them together. Make sure the BATT TEST indicator shows through the front of the TRC-235 when you reassemble it.
8. Replace **CHANNEL** on the front of the TRC-235, the back cover's three screws, the batteries (if installed) and the battery compartment cover, then replace the strap.

TROUBLESHOOTING

If your TRC-235 is not working as it should, follow these suggestions to see if you can eliminate the problem. If you cannot, take it to your local RadioShack store for assistance.

Symptom	Suggestion
Weak, bad, or no reception.	Be sure the TRC-235 is turned on.
	Be sure the volume is turned up.
	Be sure the antenna is fully extended.
	Be sure the batteries are not weak (see "Testing the Battery Power" on Page 10).
	Be sure you are not pressing PUSH TO TALK .
	Be sure CHANNEL is set to A if you have not installed additional crystals in the TRC-235.
Trouble with transmission	Be sure the antenna is fully extended.
	Be sure you are fully pressing PUSH TO TALK .
	Be sure the batteries are not weak (see "Testing the Battery Power" on Page 10).
	Be sure CHANNEL is set to A if you have not installed additional crystals in the TRC-235.

MAINTENANCE

Your RadioShack TRC-235 2 Watt 3-Channel CB Walkie-Talkie is an example of superior design and craftsmanship. The following suggestions will help you care for your TRC-235 so you can enjoy it for years.



Keep the TRC-235 dry. If it gets wet, wipe it dry immediately. Liquids might contain minerals that can corrode the electronic circuits.



Handle the TRC-235 gently and carefully. Dropping it can damage circuit boards and cases and can cause the TRC-235 to work improperly.



Use and store the TRC-235 only in normal temperature environments. Temperature extremes can shorten the life of electronic devices, damage batteries, and distort or melt plastic parts.



Keep the TRC-235 away from dust and dirt, which can cause premature wear of parts.



Wipe the TRC-235 with a damp cloth occasionally to keep it looking new. Do not use harsh chemicals, cleaning solvents, or strong detergents to clean the TRC-235.

Modifying or tampering with the TRC-235's internal components can cause a malfunction and might invalidate your TRC-235's warranty and void your FCC authorization to operate it. If your TRC-235 is not performing as it should, take it to your local RadioShack store for assistance.



SPECIFICATIONS



Receiver

Frequency Coverage ... 26.965 – 27.405 MHz
 Supplied with Channel 14 receive
 (26.670 MHz) and transmit (27.125 MHz)
 crystals in the Channel A position

Sensitivity (Maximum) 0.6 μ V

Adjacent Channel Rejection 45 dB

Squelch Adjustable from 1 μ V

Audio Output (10% THD) 400 mW

Current Drain 65–230 mA

Transmitter

Frequency Coverage ... 26.965 – 27.405 MHz

Power Input (at 12V DC) 2 W

Power Output 1 W

Spurious Emission –70 dB

Type of Modulation A3

Frequency Tolerance 0.003%

Antenna Impedance 50 Ω

Antenna Length (Maximum) 42³/₈ In.
 (1076 mm)

Current Drain 260 to 450 mA

Dimensions (HWD) 8¹³/₁₆ \times 2¹³/₁₆ \times 2¹/₈ In.
 (224 \times 72 \times 54 mm)

Weight 14.5 oz
 (410 g)

Specifications are typical; individual units might vary. Specifications are subject to change and improvement without notice.

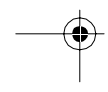
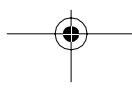
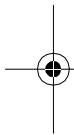



NOTES

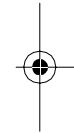
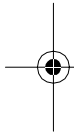

Limited Ninety-Day Warranty

This product is warranted by RadioShack against manufacturing defects in material and workmanship under normal use for ninety (90) days from the date of purchase from RadioShack company-owned stores and authorized RadioShack franchisees and dealers. EXCEPT AS PROVIDED HEREIN, RadioShack MAKES NO EXPRESS WARRANTIES AND ANY IMPLIED WARRANTIES, INCLUDING THOSE OF MERCHANTABILITY AND FITNESS FOR A PARTICULAR PURPOSE, ARE LIMITED IN DURATION TO THE DURATION OF THE WRITTEN LIMITED WARRANTIES CONTAINED HEREIN. EXCEPT AS PROVIDED HEREIN, RadioShack SHALL HAVE NO LIABILITY OR RESPONSIBILITY TO CUSTOMER OR ANY OTHER PERSON OR ENTITY WITH RESPECT TO ANY LIABILITY, LOSS OR DAMAGE CAUSED DIRECTLY OR INDIRECTLY BY USE OR PERFORMANCE OF THE PRODUCT OR ARISING OUT OF ANY BREACH OF THIS WARRANTY, INCLUDING, BUT NOT LIMITED TO, ANY DAMAGES RESULTING FROM INCONVENIENCE, LOSS OF TIME, DATA, PROPERTY, REVENUE, OR PROFIT OR ANY INDIRECT, SPECIAL, INCIDENTAL, OR CONSEQUENTIAL DAMAGES, EVEN IF RadioShack HAS BEEN ADVISED OF THE POSSIBILITY OF SUCH DAMAGES.

Some states do not allow the limitations on how long an implied warranty lasts or the exclusion of incidental or consequential damages, so the above limitations or exclusions may not apply to you.

In the event of a product defect during the warranty period, take the product and the RadioShack sales receipt as proof of purchase date to any RadioShack store. RadioShack will, at its option, unless otherwise provided by law: (a) correct the defect by product repair without charge for parts and labor; (b) replace the product with one of the same or similar design; or (c) refund the purchase price. All replaced parts and products, and products on which a refund is made, become the property of RadioShack. New or reconditioned parts and products may be used in the performance of warranty service. Repaired or replaced parts and products are warranted for the remainder of the original warranty period. You will be charged for repair or replacement of the product made after the expiration of the warranty period.

This warranty does not cover: (a) damage or failure caused by or attributable to acts of God, abuse, accident, misuse, improper or abnormal usage, failure to follow instructions, improper installation or maintenance, alteration, lightning or other incidence of excess voltage or current; (b) any repairs other than those provided by a RadioShack Authorized Service Facility; (c) consumables such as fuses or batteries; (d) cosmetic damage; (e) transportation, shipping or insurance costs; or (f) costs of product removal, installation, set-up service adjustment or reinstallation.

This warranty gives you specific legal rights, and you may also have other rights which vary from state to state.

RadioShack Customer Relations, Dept. W, 100 Throckmorton St., Suite 600, Fort Worth, TX 76102

We Service What We Sell 3/97

RadioShack
A Division of Tandy Corporation
Fort Worth, Texas 76102

6A7

Printed in China