

Cat. No. 43-797
OWNER'S MANUAL

Please read before using this equipment.

TAD -797



Digital Answering System
900MHz Cordless Speakerphone
with Caller ID/Call Waiting ID



RadioShack®



WARNING: To reduce the risk of fire or shock hazard, do not expose this product to rain or moisture.

	CAUTION RISK OF ELECTRIC SHOCK. DO NOT OPEN.	
CAUTION: TO REDUCE THE RISK OF ELECTRIC SHOCK, DO NOT REMOVE COVER OR BACK. NO USER-SERVICEABLE PARTS INSIDE. REFER SERVICING TO QUALIFIED PERSONNEL.		



This symbol is intended to alert you to the presence of uninsulated dangerous voltage within the product's enclosure that might be of sufficient magnitude to constitute a risk of electric shock. Do not open the product's case.



This symbol is intended to inform you that important operating and maintenance instructions are included in the literature accompanying this product.

This telephone has been tested and found to comply with all applicable standards.

Important: Cordless phones such as this one require AC power to operate. When the AC power is off, you cannot make or receive calls using your TAD-797. To be safe, you should also have a phone that does not need AC power to operate (not a cordless phone) so you can still make and receive calls if there is an AC power failure.

Important Caller ID Information

To use the TAD-797's Caller ID and Call Waiting with Caller ID features, you must be in an area where those services are available and you must subscribe to those services through your local phone company.

Where Caller ID is offered, one or more options are generally available:

- caller's number only
- caller's name only
- caller's name and number

We recommend you record the TAD's serial number here. The number is on the bottom of the base.

Serial Number: _____

FEATURES

Your RadioShack TAD-797 Digital Answering System 900MHz Cordless Speakerphone combines a 900MHz cordless telephone with a 50-memory Caller ID unit and a digital TAD (Telephone Answering Device).

The TAD-797's telephone uses advanced digital spread spectrum technology to give you superior audio quality and the utmost security. Its cordless operation lets you move freely around your home or office.

The TAD-797's Caller ID unit records each caller's telephone number (and name, if available in your area) and the day and time of the call, as provided by your local phone company to Caller ID service subscribers. If you have Call Waiting with Caller ID, the TAD-797 shows you the incoming caller information, even when you are already on the phone.

The TAD stores up to 15 minutes of messages on a computer chip and records each message's day and time. This gives you advanced capabilities over tape-based answering machines:

- You can delete individual messages and save the rest.
- There are no tapes to bother with and no tape mechanisms to wear out.

The remote operation feature lets you operate your TAD from a touch-tone phone (or from a rotary phone with a pocket tone dialer).

Telephone Features

900 MHz Operation — provides longer range and less interference than many other cordless phones.

Spread Spectrum Technology — spreads the signal across several frequencies, providing additional security for your phone conversations.

Caller ID Memory — stores up to 50 Caller ID records.

Call Waiting ID — you can set the TAD-797 to display Caller ID information about an incoming call when you are on the phone (if you subscribe to this service from your local phone company).

Easy-to-Read Liquid Crystal Display — lets you see who is trying to reach you before you answer the phone.

Speakerphone — lets you talk without using the handset.

Two-Way Intercom/Paging System — lets you send a signal from the base to the handset, or from the handset to the base, to page someone or locate the handset when it is away from the base. If someone answers, you can use the TAD-797 as an intercom.

Volume Controls — let you adjust the volume you hear through the handset and speakerphone.

Ample Talk and Standby Time — the supplied battery pack (when fully charged) provides about 3½ hours of talk time or 7 days of standby time.

10 Number Memory Dialing — lets you store 10 numbers in memory for easy dialing.

Security Access-Protection Code — helps prevent other cordless phone users from using your phone line while the handset is off the base.

COM-LOK® — ensures that other cordless phone users cannot use your phone line when the handset is on the base.

Auto Talk — lets you set the handset so you can answer a call by simply lifting the handset from the base or by pressing any key when the handset is away from the base.

Redial — lets you quickly redial the last number dialed.

Flash — sends an electronic switch-hook signal for use with special phone services, such as Call Waiting.

Tone/Pulse Dialing — lets you use either type of service, and you can easily switch from pulse to tone dialing for long-distance, bank-by-phone, or other special services.

Hearing-Aid Compatibility — lets you use your phone with hearing aids that have a T (telephone) switch.

TAD Features

Ample Recording Time — you can record up to 15 minutes of messages.

Day/Time Stamp — records the day and time each message was recorded.

Remote Operation — lets you use a touch-tone phone (or rotary phone and pocket tone dialer) to operate the TAD while you are away from your home or office.

Remote Answer-ON — lets you call the TAD from a remote location even when it is not set to answer calls.

Digital Volume Control — lets you precisely adjust the speakerphone and message playback.

Prerecorded Messages — give you the option one of using one of two pre-recorded outgoing messages or recording your own.

Announcement Only — lets you play an announcement for callers to hear, without recording their messages.

Message Counter — shows the number of messages the TAD has recorded.

Programmable PIN — you can set a two-digit personal identification number (PIN) for secure remote operation.

Call Screening — lets you listen as a caller leaves a message so you can decide whether or not to answer the call.

Memo Recording — lets you leave messages for yourself or others in your home or office. You can also record your phone conversation.

Adjustable Ring Number — lets you set the TAD to answer after three or five rings.

Toll-Saver — lets you avoid unnecessary charges when you call by long distance to check your messages.

Phone Pick-Up Detection — stops recording when you pick up any phone on the same line as the TAD, and resets to answer the next call.

READ THIS BEFORE INSTALLATION

We have designed your phone to conform to federal regulations, and you can connect it to most telephone lines. However, each device that you connect to the phone line draws power from the phone line. We refer to this power draw as the device's *ringer equivalence number*, or REN. The REN is on the bottom of the base.

If you are using more than one phone or other device on the line, add up all the RENs. If the total is more than five, your phones might not ring. In rural areas, a total REN of three might impair ringer operation. If ringer operation is impaired, remove a device from the line.

FCC STATEMENT

Your TAD-797 complies with Part 68 of *FCC Rules*. You must, upon request, provide the FCC registration number and the REN to your phone company. These numbers are on the bottom of the base.

You must not connect your phone to any of the following:

- coin-operated systems
- party-line systems
- most electronic key phone systems

Note: Your telephone operates on standard radio frequencies, as allocated by the FCC. Even though the security access-protection code prevents unauthorized use of your phone line, it is possible for other radio units operating on similar frequencies within a certain area to unintentionally intercept your conversations and/or cause interference. This lack of privacy can occur with any cordless phone.

CONTENTS

Installation	8
Mounting the Phone	8
On a Desk Top	8
On a Wall Plate	9
Directly on the Wall	10
Connecting and Charging the Battery Pack	12
Setting the Dialing Mode	13
Turning the Base's Ringer On and Off	14
Setting the Handset's Ringer Volume	14
Setting the Number of Rings	14
Setting the Day/Time	14
Setting Autotalk	15
Turning Caller ID/Call Waiting On/Off	15
Storing Your Area Code	16
Telephone Operation	17
Making and Receiving Calls with the Handset	17
Adjusting the Handset Volume	17
Answering Calls with the Speakerphone	17
Switching Between the Handset and Speakerphone	18
Using Both the Handset and Speakerphone	18
Using FLASH	18
Using REDIAL	19
Using Tone Services on a Pulse Line	19
Using Page/Intercom	19
Transferring a Call Between the Handset and Base	20
Memory Dialing	20
Storing a Number and Name in Memory	21
Editing or Deleting a Memory Number	22
Entering a Pause	22
Dialing a Memory Number	23
Chain-Dialing Service Numbers	23
Testing Stored Emergency Numbers	23
Using a Headset	23
Caller ID Operation	25
Reviewing Caller ID Records	25
Caller ID Messages	26
Dialing Numbers from a Caller ID Record	26
Storing a Caller ID Record to Memory	27
Deleting Caller ID Records	27



TAD Operation	28
Selecting the Outgoing Message	28
Recording/Deleting an Outgoing Message	28
Setting the Record Time	29
Setting the TAD to Answer Calls	29
Screening Calls	29
Recording Incoming Messages	29
Recording a Memo	30
Recording a Conversation	30
Playing Messages	30
Adjusting the TAD's Volume	31
Deleting Messages	31
Setting the Remote Operation PIN	32
Remote Operation	32
Using Toll-Saver	32
Using Remote Commands	33
Troubleshooting	34
Care and Maintenance	36
Replacing the Battery Pack	37
The FCC Wants You to Know	38
Lightning	38

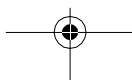
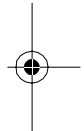
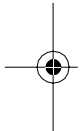

INSTALLATION

MOUNTING THE PHONE

You can place the TAD-797's base on a desk or table, mount it on a standard wall plate, or mount it directly on a wall. Choose a location that is:

- near an AC outlet
- near a modular telephone line jack
- out of the way of normal activities
- away from electrical machinery, electrical appliances, metal walls or filing cabinets, wireless intercoms, alarms, and room monitors
- away from other cordless phones

The base's location affects the phone's range. If you have a choice of several locations, try each to see which provides the best performance.

Caution: You must use a Class 2 power source that supplies 9 volts DC and delivers at least 500 mA. Its center tip must be set to positive and its plug must fit the TAD-797's **DC IN 9V** jack. The supplied AC adapter meets these specifications. Using an adapter that does not meet these specifications could damage the TAD-797 or the adapter.

Notes:

- Your telephone connects directly to a modular telephone line jack. If your phone line jack is not a modular jack, you can update the wiring yourself, using jacks and adapters available at your local RadioShack store. Or, you can let the phone company update the wiring for you.

- The USOC number of the jack to be installed is RJ11C (RJ11W for a wall plate).

On a Desk Top

1. Insert the bracket's tabs into the base's upper tab slots as shown, then press down on the bracket's clips and insert them into the upper clip slots.

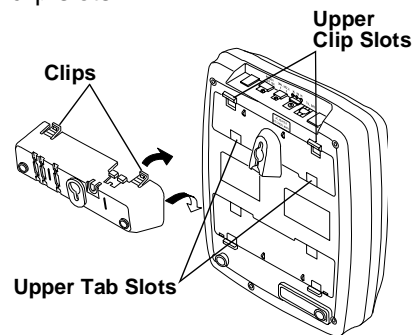

2. Route the supplied long modular cord through the strain relief slot on the side of the bracket, then plug the cord into the **TEL LINE** jack on the back of the base.

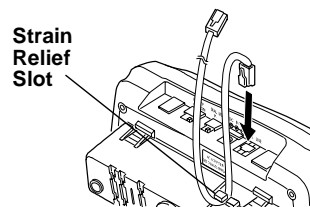

3. Plug the modular cord's other end into a modular telephone line jack.

4. Insert the supplied AC adapter's barrel plug into the **DC IN 9V** jack on the back of the base.

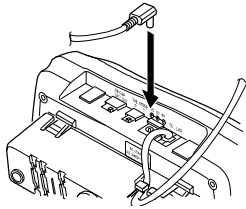

5. Route the adapter's cord through the strain relief slot on the bottom of the bracket.

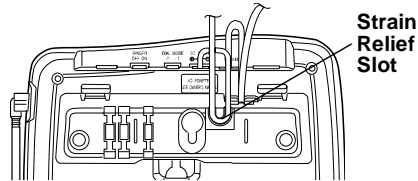

6. Plug the adapter into a standard AC outlet.

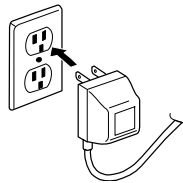

7. Lift the base's antenna to a vertical position.

On a Wall Plate

1. Insert the bracket's tabs into the base's lower tab slots as shown, then press down on the bracket's clips and insert them into the lower clip slots.

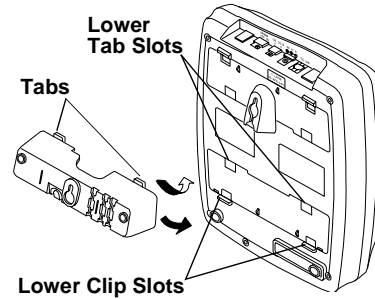

2. Plug one end of the supplied short modular cord into the **TEL LINE** jack on the back of the base.

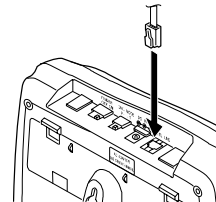

3. Insert the supplied AC adapter's barrel plug into the **DC IN 9V** jack.

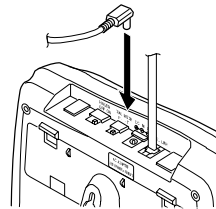

- Route the adapter cord through the narrow groove on the bracket.

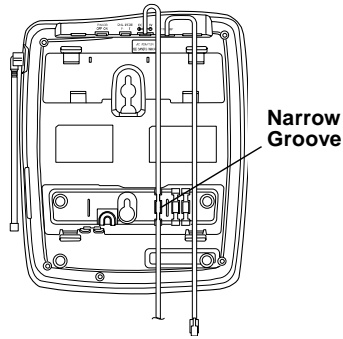

- Plug the modular cord's other end into the wall plate jack, then align the bracket's keyhole slots with the wall plate studs and slide the base downward to secure it.

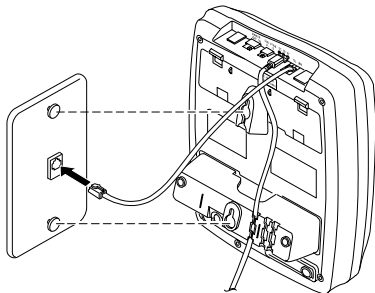

- Plug the adapter into a standard AC outlet.

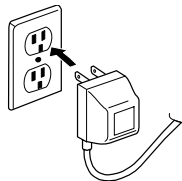

- Press and lift out the handset holder, flip it over as shown, then snap it back into place so it holds the handset.

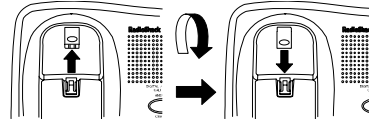

- Lift the base's antenna to a vertical position.

Directly on the Wall

For this mounting method, you need two screws (not supplied) with heads that fit into the keyhole slots on the bottom of the base.

- Drill two holes $3^{15}/16$ inches (100 mm) apart. Then thread a screw into each hole, letting the heads extend about $5/16$ inch (8 mm) from the wall.

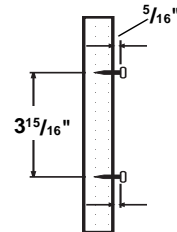

- Insert the bracket's tabs into the base's lower tab slots as shown, then press down on the bracket's clips and insert them into the lower clip slots.

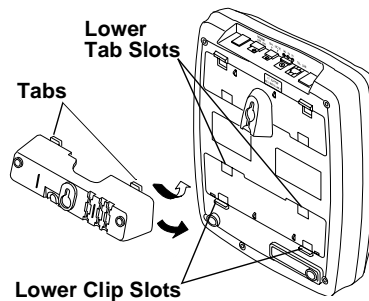

3. Plug one end of the supplied long modular cord into the **TEL LINE** jack on the back of the base.

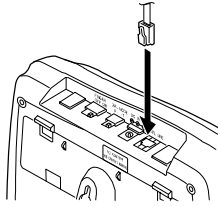

4. Insert the supplied AC adapter's barrel plug into the **DC IN 9V** jack.

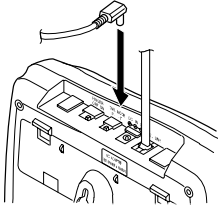

5. Route the modular and adapter's cords through the grooves on the bracket as shown.

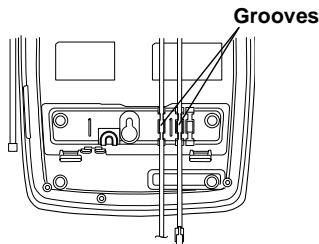

6. Align the bracket's keyhole slots with the mounting screws and slide the base downward to secure it.

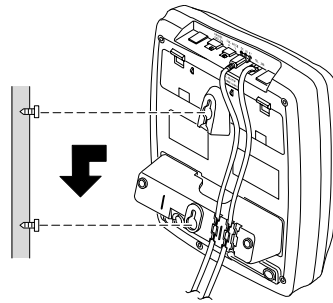

7. Plug the modular cord's other end into a modular telephone line jack.
8. Plug the adapter into a standard AC outlet.

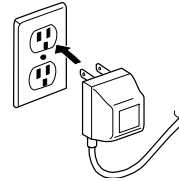

9. Press and lift out the handset holder, flip it over as shown, then snap it back into place so it holds the handset.

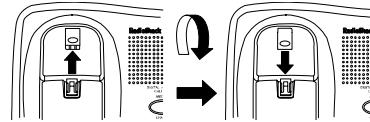

10. Lift the base's antenna to a vertical position.

CONNECTING AND CHARGING THE BATTERY PACK

The TAD-797 comes with a rechargeable nickel-cadmium battery pack installed in the handset, but not connected. Before using your phone, you must connect the battery pack, then charge it for about 24 hours.

1. Press down and slide off the battery pack compartment cover.

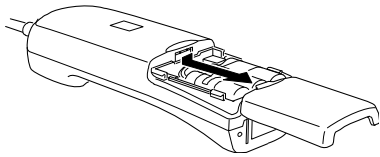

2. Unfasten the plastic retainer strap and lift the battery pack out of the compartment. Plug the battery pack's connector into the socket in the compartment. The connector fits only one way.

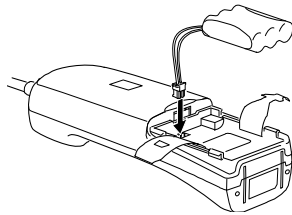

3. Put the battery pack in the compartment and fasten the retainer strap.
4. Replace the cover.

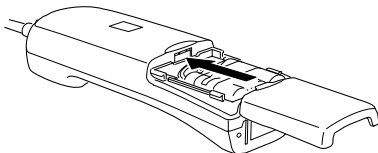

To charge the battery pack, simply place the handset on the base, facing either up or down. The CHARGE indicator on the base lights and **Total:00** appears on the handset's display.

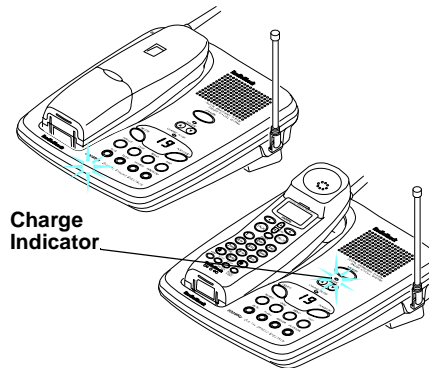

Recharge the battery pack when **Low Battery** appears and a beep sounds.

Notes:

- When you first use the phone after charging or recharging the battery pack, the phone might not work and you might hear a five-beep error signal when you press **TALK**. If this happens, return the handset to the base for about 5 seconds. This resets the security access-protection code.
- If the CHARGE indicator does not light when you place the handset on the base, be sure the AC adapter is correctly and securely connected.

Also, check the charging contacts on the handset and base. If the contacts are dirty or tarnished, clean them with a pencil eraser.

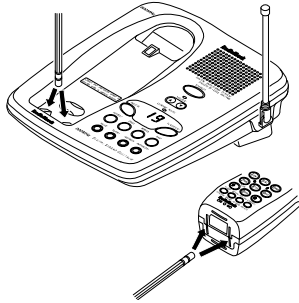

- About once a month, fully discharge the battery by keeping the handset off the base until **Low Battery** appears. Otherwise, the battery pack loses its ability to fully recharge.
- If the battery pack becomes weak during a call, the handset beeps every few seconds and **Low Battery** flashes on the display. If this happens, you must recharge the battery pack before you can make another call.
- If the battery pack is completely discharged or the base loses power while the handset is away from it, place the handset on the base to reset the security access-protection code. If it was the handset that lost power, recharge the battery pack.
- The supplied battery pack should last for about a year. When it loses its ability to fully recharge, order a replacement battery pack through your local RadioShack store (see "Replacing the Battery Pack" on Page 37).

SETTING THE DIALING MODE

Set **DIAL MODE** on the back of the base for the type of service you have. If you are not sure which type you have, after you charge the handset battery pack, do this simple test.

1. Set **DIAL MODE** to **T** (tone).

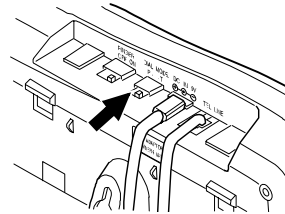

2. Press **TALK** on the handset and listen for a dial tone.

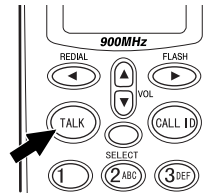

3. Press any number other than **0**.

Note: If your phone system requires that you dial an access code (9, for example) before you dial an outside number, do not press the access code number either.

If the dial tone stops, you have touch-tone service. Leave **DIAL MODE** set to **T**.

If the dial tone continues, you have pulse service. Set **DIAL MODE** to **P** (pulse).

4. Press **TALK** or place the handset on the base to hang up.

TURNING THE BASE'S RINGER ON AND OFF

To turn off the base's ringer, set **RINGER** on the back of the base to **OFF**. You can still make or receive calls using this phone, and telephones on the same line and the TAD's handset still ring when there is an incoming call.

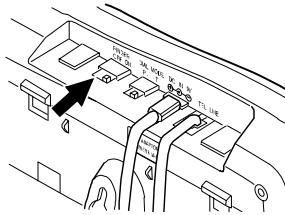

To turn on the base's ringer, set **RINGER** to **ON**.

SETTING THE HANDSET'S RINGER VOLUME

At any time except during a call, press **t** or **s** to set the handset's ringer volume. The phone rings at the selected volume and the display shows **Ringer Low** or **Ringer High**.

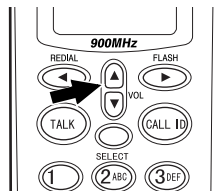

SETTING THE NUMBER OF RINGS

Set **RING TIME** on the side of the base to **3**, **5**, or **T/S** to select how long the TAD waits to answer a call (3 rings, 5 rings, or toll-saver).

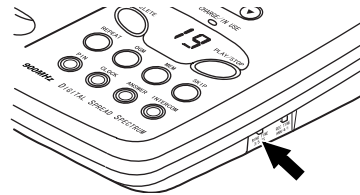

Note: If you plan to check messages by long distance, set **RING TIME** to toll-saver (see "Using Toll-Saver" on Page 32).

SETTING THE DAY/TIME

You must set the day of the week and time so the TAD can record the correct day and time of each message.

Note: If you wait more than 15 seconds between each key press, the TAD exits the time setting process. Start again at Step 1.

1. Hold down **CLOCK** until the TAD beeps. The TAD announces the currently set day and displays the day's number (0 for Sunday, 1 for Monday, and so on).

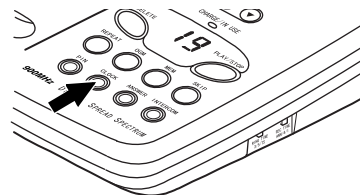

2. To change the day of the week, repeatedly press **SKIP** to move forward or **REPEAT** to move backward.

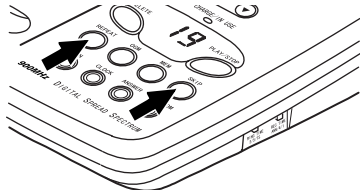

3. Press **CLOCK**. The TAD announces the hour. To change the hour, repeatedly press **SKIP** or **REPEAT**.
4. Press **CLOCK**. The TAD announces the minutes. To change the minutes, repeatedly press **SKIP** or **REPEAT**.
5. Press **CLOCK**. The TAD announces "AM" or "PM," and **A** or **P** appears. Press **SKIP** or **REPEAT** to change this setting.
6. Press **CLOCK**. The TAD announces the day and time.

SETTING AUTOTALK

Your phone is preset so you must press **TALK** when you lift the handset from the base to answer a call. With auto talk turned on, you can answer a call by just lifting the handset from the base or by pressing any key when the handset is away from the base.

Follow these steps to turn auto talk on or off.

1. Lift the handset and press **FUNCTION**. A menu appears with **Auto Talk** selected.

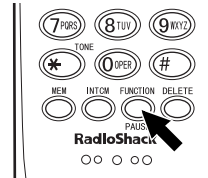

2. Press **SELECT** to change the auto talk setting. **On** or **Off** appears indicating the selected setting.

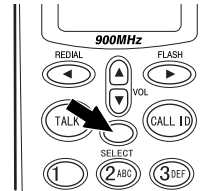

3. To clear the display, press **FUNCTION** or return the handset to the base.

TURNING CALLER ID/ CALL WAITING ON/OFF

If you have Call Waiting with Caller ID service, you can set the TAD-797 to show Caller ID information for an incoming call even if you are already on the phone.

Follow these steps to turn the Caller ID/ Call Waiting feature on or off.

1. Lift the handset and press **FUNCTION**.

2. Press **2** or **t** to select **CIDCW** (Caller ID/Call Waiting).

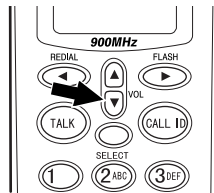

3. Press **SELECT** to change the Caller ID/Call Waiting setting. **On** or **Off** appears indicating the selected setting.
4. Return the handset to the base to store the new setting.

3. Press **SELECT**, then enter your 3-digit area code. If you make a mistake, repeatedly press **◀** or **▶** to move the cursor over the incorrect digit, then enter the correct number.

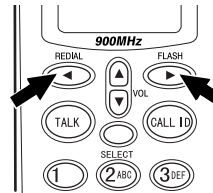

Note: If an area code is already stored, it appears on the display. To delete the area code, press **DELETE** three times. Or, simply enter a new area code to overwrite the old one.

STORING YOUR AREA CODE

To quickly dial a number from a Caller ID record (see “Dialing Numbers from a Caller ID Record” on Page 26) or to correctly store a number from a record into a memory dialing location (see “Storing a Caller ID Record to Memory” on Page 27), you must store your local area code in the TAD-797’s memory. Then, when you dial from a Caller ID record, the TAD-797 skips the area code if it matches the one you stored.

Follow these steps to store your area code.

1. Lift the handset and press **FUNCTION**.
2. Press **3** (or **t** twice) to select **Area Code**.

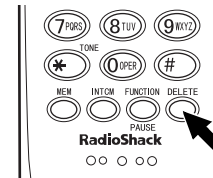

4. Press **SELECT** to store the area code.
5. To clear the display when you finish, press **FUNCTION** or return the handset to the base.

TELEPHONE OPERATION

MAKING AND RECEIVING CALLS WITH THE HANDSET

To make a call, lift the handset, then press **TALK**. The IN USE indicator on the base lights. Dial the number. You see the number as you dial, then (about 5 seconds later) the call's elapsed time.

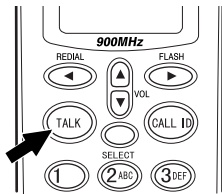

Note: You can also dial the number *before* you press **TALK**. If you make a mistake, repeatedly press ◀ or ▶ until the cursor is over the incorrect digit, then enter the correct number.

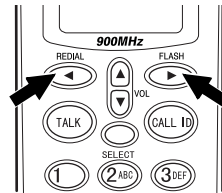

To answer a call, lift the handset from the base and press **TALK**. If auto talk is on, just lift the handset from the base, or, if the handset is away from the base, press any key to answer a call.

To end a call, place the handset on the base or press **TALK**.

ADJUSTING THE HANDSET VOLUME

To adjust the volume of the sound you hear through the handset, during a call, press **t** for normal volume or **s** for high volume. The display shows **Volume Normal** or **Volume High**.

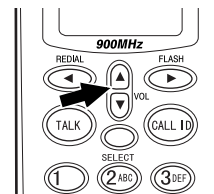

When you hang up, the volume returns to the normal setting.

ANSWERING CALLS WITH THE SPEAKERPHONE

To answer a call using the speakerphone, press **SPEAKER**. The **SPEAKER** indicator lights.

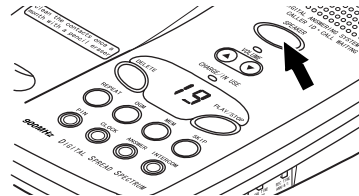

To adjust the speakerphone's volume, repeatedly press **VOLUME** s or t on the base. The volume setting from 1 (lowest) to 10 (highest) appears in the message counter window.

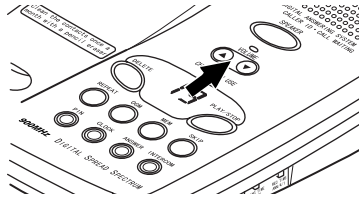

To end a speakerphone call, press **SPEAKER** again.

SWITCHING BETWEEN THE HANDSET AND SPEAKERPHONE

To switch to the speakerphone while you are using the handset, press **SPEAKER** on the base. When you hear the conversation or dial tone on the speakerphone, press **TALK** on the handset.

To switch to the handset while you are using the speakerphone, simply lift the handset off the base. If the handset is away from the base, press **TALK**, then press **SPEAKER**.

USING BOTH THE HANDSET AND SPEAKERPHONE

If someone else is using the speakerphone, press **TALK** on the handset to join the conversation. If someone else is using the handset, press **SPEAKER** on the base to join the conversation.

During the call, one person can hang up and let the call continue at the other keypad. Or, both people can hang up to end the call.

Note: If you hear a high-pitched noise from the base's speaker, the handset and the base are too close together.

USING FLASH

FLASH performs the electronic equivalent of a switchhook operation for special services, such as Call Waiting.

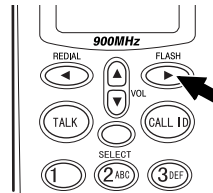

For example, if you have Call Waiting, press **FLASH** to answer an incoming call without disconnecting the current call. Press **FLASH** again to return to the first call.

Note: If you do not have any special phone services, pressing **FLASH** might disconnect the current call.

USING REDIAL

To quickly dial the last number dialed, press **TALK**, then press **REDIAL**.

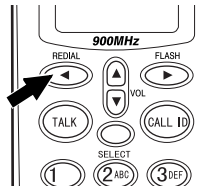

Notes:

- You can also press **REDIAL** on the handset first, then press **TALK**.
- The redial memory holds up to 32 digits, so you can redial long-distance as well as local numbers.
- The redial memory also holds pause entries. See "Entering a Pause" on Page 22.
- When you press **FLASH** and press any number key, the redial memory stores the number entered after **FLASH**, deleting any previous entry (see "Using FLASH" on Page 18).

USING TONE SERVICES ON A PULSE LINE

Some special services, such as bank-by-phone, require tone signals. If you have pulse service, you can still use these special tone services by following these steps.

1. Be sure **DIAL MODE** is set to **P**.
2. Dial the service's main number.

3. When the service answers, press **TONE** (*) on the handset. Any additional numbers you dial are sent as tone signals.

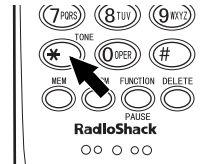

4. When you hang up, the phone automatically resets to pulse dialing.

USING PAGE/INTERCOM

You can use the TAD-797 as a two-way pager and intercom between the base and the handset. This is useful if the handset is away from the base and you want to locate it, or if you want to have a conversation between someone with the handset and someone at the base.

To page the base from the handset, press **INTCM**. **Paging Base** appears on the handset display, and both the base and handset ring. Press **SPEAKER** or **INTERCOM** on the base to answer the page. The handset display changes to **Intercom**.

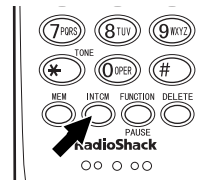

Storing a Number and Name in Memory

Note: An error tone sounds and the phone exits the storing process if you wait more than 20 seconds between each keypress.

1. Lift the handset.
2. Hold down **MEM** until **Memory Store** and a list of memory location numbers (and names, if any) appear.

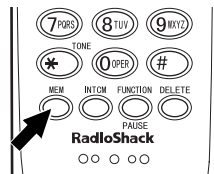

3. Choose a memory location (0–9) by pressing a number or by repeatedly pressing s or t.

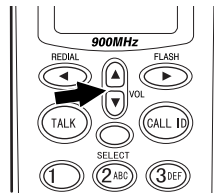

4. To store a name, press **SELECT**. **Store Name** appears.

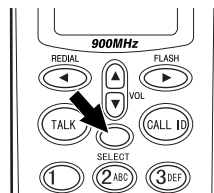

If you do not want to enter a name, skip to Step 6. **<Memory n>** appears as the name (**n** is the memory location number you selected).

5. To enter a name, use t or s to select the characters and ◀ or ▶ to move the cursor.

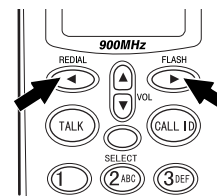

Repeatedly press t to see the characters in alphabetical order. (The display shows uppercase letters first, then lowercase letters, numbers, and special characters.)

Notes:

- Press s to see the characters in reverse order.
- You can hold down s or t to scroll rapidly through the characters.

If you make a mistake, move the cursor over the error, then enter the correct character, or press **DELETE** to delete a character. To delete all the characters, hold down **DELETE** for at least 1 second.

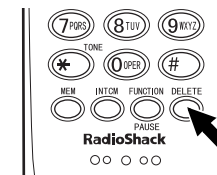

6. Press **SELECT**. **Store Number** appears.

7. Enter the phone number and any tone or pause entries (see "Using Tone Services on a Pulse Line" on Page 19 and "Entering a Pause" on Page 22).

Instead of using the lower keypad keys, you can use **t** or **s** to enter the number and other entries and **◀** or **▶** to move the cursor. Repeatedly press **t** to see the numbers first, then special characters, including hyphens, pause entries (**P**), and tone entries (*). Press **s** to see them in reverse order.

Note: When storing a number, press **s** once to enter a - or twice to enter a **P** (pause entry). Press **▶** before you enter the next number.

8. Press **SELECT**. The phone beeps and **Memory n Stored** appears. After 2 seconds, **Memory Store** appears, and you can repeat Steps 3–8 to store more numbers.

To replace a stored number, simply store a new one in its place.

Editing or Deleting a Memory Number

Follow these steps to edit or delete a number stored in the handset's memory.

1. Lift the handset.
2. Hold down **MEM** until **Memory Store** and a list of memory location numbers appear on the display.

3. Choose a memory location (0–9) by pressing a number or by repeatedly pressing **s** or **t**.
4. Press **SELECT**. The options listed below appear. Press **s** or **t** to choose an option, follow the instructions listed, then press **SELECT**.

Edit Memory n — Edit the record as described in Steps 5 through 8 of "Storing a Number and Name in Memory" on Page 21.

Delete Memory n — The display prompts you to confirm the deletion. Move the cursor to **Yes** or **No**, then press **SELECT** or **DELETE**. The phone beeps, and **Memory n Deleted** appears.

Go Back — Returns you to the list of memory numbers.

5. When you finish editing or deleting memory numbers, press **MEM** or return the handset to the base to clear the **Memory Store** display.

Entering a Pause

In some telephone systems, you must dial an access code (9, for example) and wait for a second dial tone before you can dial an outside number. You can store the access code with the phone number. However, you should also store a pause after the access code to allow the outside line time to connect.

To store a 2-second pause, press **PAUSE** or press **s** twice to select **P** on the display. You can add more pause entries for a longer pause.

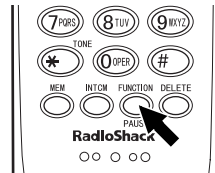

Dialing a Memory Number

To dial a memory number, lift the handset and press **MEM**. The list of memory location numbers appears. Choose a memory location (0–9) by pressing a number or by repeatedly pressing **s** or **t**, then press **TALK**.

You can also press **TALK** first, then choose a memory number to dial, but the handset will not display the list of memory numbers.

Note: If you select an empty memory location, the handset beeps 5 times.

Chain-Dialing Service Numbers

For quick recall of numbers for special services (such as bank by phone), store each group of numbers in its own memory location.

Dial the service's main number first. Then, at the appropriate place in the call, press **MEM** and the number for the location where the additional information is stored.

Testing Stored Emergency Numbers

If you store an emergency service's number (police department, fire department, ambulance) and you choose to test the stored number, make the test call during the late evening or early morning hours to avoid peak demand periods. Also, remain on the line to explain the reason for your call.

USING A HEADSET

You can talk with hands-free convenience using an optional headset that has a $\frac{3}{32}$ -inch (2.5-mm) plug. Contact your local RadioShack store for a suitable headset.

To connect the headset, open the rubber cover marked  on the side of the handset, then insert the headset's plug into the jack.

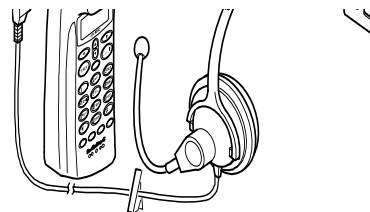

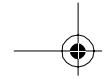

Notes:

- Connecting a headset disconnects the handset's earpiece and microphone.
- **VOL** s or t on the handset also controls the connected headset's volume.
- If you place the handset on the base to recharge it while the headset is connected, be sure the handset seats properly.

With a headset connected, you can make or answer calls as usual using the handset and answer calls as usual using the speakerphone.

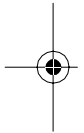

You can use a headset holder (available from your local RadioShack store) to hang the handset on your belt for greater convenience.

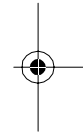

When you finish using the headset, disconnect it from the handset and close the rubber cover to protect the jack.

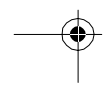
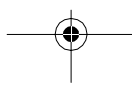

CALLER ID OPERATION

If you subscribe to Caller ID service from your phone company, the phone company sends information about the call, as well as the time and date, between the first and second rings of every call you receive.

The TAD-797 displays this information when it receives a call, and it stores up to 50 Caller ID records for later review. It also shows if caller information is unavailable or if the name and number were blocked by the caller (see "Caller ID Messages" on Page 26).

If you subscribe to Call Waiting with Caller ID, you will hear a tone through the handset when a call comes in, then the Caller ID record appears. If you want to answer the incoming call, press **FLASH**. To resume the previous phone conversation, press **FLASH** again.

If the phone's Caller ID memory becomes full, any new call replaces the oldest call's record.

REVIEWING CALLER ID RECORDS

To review the Caller ID records, lift the handset and press **CALL ID**. The number of new Caller ID records, if any, and the total number of records appears.

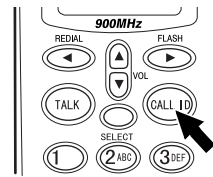

Hint: If the handset is faceup on the base, it always shows the number of Caller ID records, so you can easily see if you have new records to review.

Repeatedly press **t** to scroll through the Caller ID records from the newest to the oldest. Press **s** to scroll back through the records. To scroll quickly, hold down **t** or **s**.

When you scroll past the oldest record, **End** appears. When you scroll past the newest record, the record totals appear.

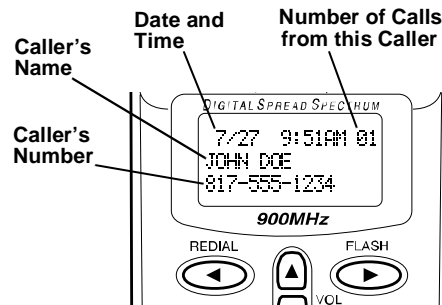

Caller ID Messages

Display	Description
New :XX Total :XX	Shows the number of new Caller ID records (records you have not reviewed) and the total number of records.
Private Name Private Number	The caller has blocked the Caller ID information from being sent.
Unknown Name Unknown Number	The caller is not within a Caller ID service area.
Error	Appears if there was an error during the transmission of Caller ID information.
End	Appears when you scroll past the oldest Caller ID record.

DIALING NUMBERS FROM A CALLER ID RECORD

To dial a local number stored in a Caller ID record, recall the record, then press **TALK**. If it is a long distance call, press **1** (1 appears before the displayed number) before pressing **TALK**.

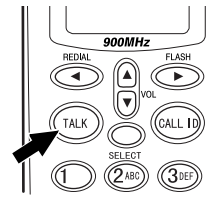

Notes:

- If a Caller ID record does not contain a phone number (if it was blocked by the caller, for example) you cannot dial from that record.
- You cannot dial from a Caller ID record if the number is longer than 16 digits.

STORING A CALLER ID RECORD TO MEMORY

Follow these steps to store the name and number from a Caller ID record into a memory location.

1. Recall the record you want to store, then press **MEM**. **Select Location** appears.

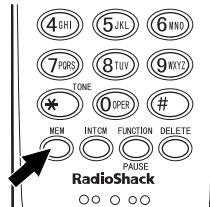

2. Choose a memory location by pressing its number (0–9) or scrolling through the list using t or s, then press **SELECT**.

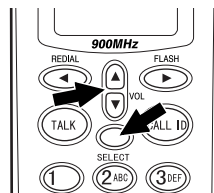

If the selected location is empty, the handset beeps to confirm that it stored the number, then the Caller ID record appears.

If a record exists in the selected location, **Replace Memory?** appears, prompting you to confirm the replacement. Move the cursor to **Yes** or **No**, then press **SELECT**.

DELETING CALLER ID RECORDS

You can delete Caller ID records individually or all at once.

To delete a single record, recall it, then press **DELETE**. **Delete Message?** appears. Move the cursor to **Yes** or **No**, then press **SELECT** or **DELETE**.

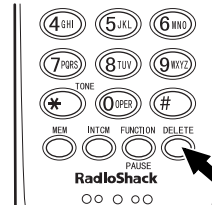

To delete all the records at once, press **DELETE** while the total number of records is on the display. **Delete All?** appears. Move the cursor to **Yes** or **No**, then press **SELECT** or **DELETE**.

TAD OPERATION

SELECTING THE OUTGOING MESSAGE

The TAD has two prerecorded outgoing messages. One asks the caller to leave a message: "Hello, no one is available to take your call. Please leave a message after the tone." The TAD uses this message when **REC TIME** is set to **1** or **4** (see "Setting the Record Time" on Page 29).

The other is simply an announcement and does not let the caller leave a message: "Hello, no one is available to take your call." The TAD uses this message when **REC TIME** is set to **ANN** (announcement only)

You can also record your own message (see "Recording/Deleting an Outgoing Message"). When you record your own outgoing message, the TAD uses it for all **REC TIME** settings.

To switch between your outgoing message and the TAD's prerecorded message, press **OGM**. When the current message begins to play, press **OGM** again. The TAD switches to the other message and plays it.

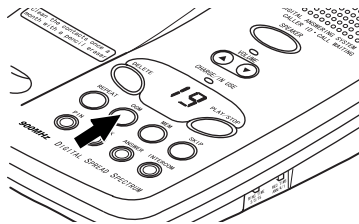

RECORDING/DELETING AN OUTGOING MESSAGE

To record your outgoing message (up to 30 seconds long), hold down **OGM** until the TAD beeps and **--** appears. When you finish your message, press **STOP**. The TAD plays back your message.

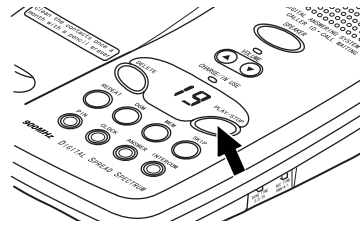

Hint: Do not tell callers that you are not home. Instead, say that you cannot come to the phone right now.

Note: The TAD-797 cannot record an outgoing message less than two seconds long.

To delete your outgoing message and use the TAD's prerecorded messages, hold down **OGM** until the TAD beeps. Then press **OGM** again within two seconds.

The TAD stops recording up and resets to answer the next call when:

- the caller hangs up
- the maximum message length is reached
- the TAD detects a busy signal or more than 7 seconds of silence
- you pick up the TAD-797's handset or any phone on the same phone line

Note: When the TAD's message memory is full, **FL** appears on the display.

RECORDING A MEMO

A memo is a message you can record at the TAD for yourself or others in your home or office. The TAD-797 stores memos as incoming messages (see "Playing Messages").

To record a memo, hold down **MEM** on the base until the TAD beeps and -- appears in the message counter window, then speak your message (up to four minutes long). When you finish the memo, press **STOP**.

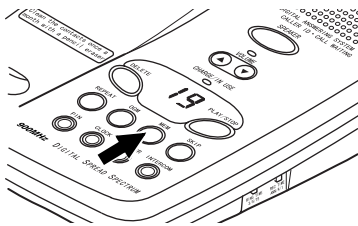

Note: The TAD-797 cannot record a memo less than two seconds long.

RECORDING A CONVERSATION

The TAD-797 lets you record both sides of a telephone conversation.

Note: It is illegal in some areas to record a conversation without the consent of all parties to the conversation, including the phone company. Check the laws in your area before you use the two-way recording feature.

To start recording a phone conversation, hold down **MEM** on the base until the TAD beeps and -- appears. As it records the conversation, the TAD beeps every 15 seconds to let the caller know that the conversation is being recorded. To stop recording, press **STOP**.

The TAD-797 stores a recorded conversation as a message (see "Playing Messages" on Page 30).

Note: The TAD-797 cannot record a conversation less than two seconds long.

PLAYING MESSAGES

After the TAD-797 has recorded a message, its message counter shows the total number of messages stored. If you have new messages, the number flashes.

To play your messages, press **PLAY**. The TAD announces the number of new and old messages, then plays the new messages. The message number appears as each message plays, and the TAD announces the day and time of the call at the end of each message.

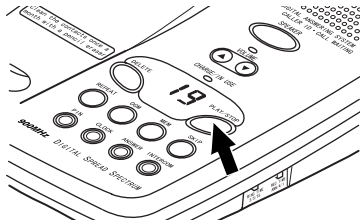

To play all messages after playing the new messages, press **PLAY** again.

To skip to the next message, press **SKIP** during playback.

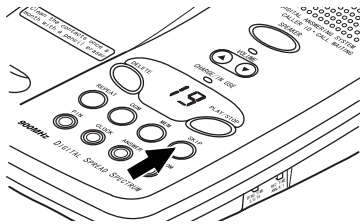

To replay the current message from the beginning, press **REPEAT**. If you press **REPEAT** within 5 seconds after a message begins playing, the TAD replays the previous message.

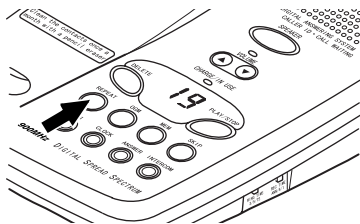

ADJUSTING THE TAD'S VOLUME

To adjust the speaker's volume, repeatedly press **VOLUME s** or **t** on the base. The volume setting from **1** (lowest) to **10** (highest) appears in the message counter window.

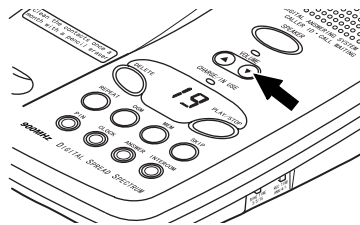

DELETING MESSAGES

To delete the current message while it is playing, hold down **DELETE** until the TAD beeps.

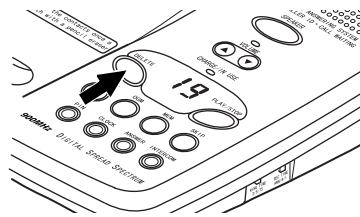

To delete all messages at once, while messages are not playing, hold down **DELETE** on the base until the TAD beeps and **0** appears in the message counter window.

Note: You cannot delete new (unplayed) messages. If you try to delete all messages at once while you still have new messages, the TAD sounds five quick beeps and does not delete any messages.

SETTING THE REMOTE OPERATION PIN

The TAD-797's two-digit remote operation PIN (personal identification number) prevents unauthorized remote access to your messages. The PIN is preset to 80. Follow these steps to change the PIN to any number from 00 to 99.

Note: If you wait more than 15 seconds between each keypress, the TAD exits the PIN setting process. Start again at Step 1.

1. Hold down **PIN** until the TAD beeps and **00** appears in the message counter window.

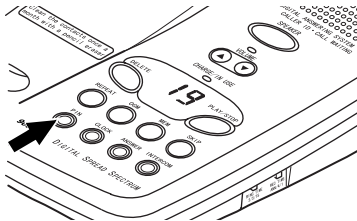

2. Press **SKIP** to set the first digit of the PIN higher or **REPEAT** to set it lower. Then press **PIN**.
3. Press **SKIP** or **REPEAT** to set the second digit of the PIN, then press **PIN**. The TAD announces the new PIN.

To check your PIN at any time, press **PIN**. The PIN appears in the message counter window, and the TAD announces it.

Note: If the TAD loses power for longer than about one hour, the PIN resets to 80.

REMOTE OPERATION

While you are away from your home or office, you can use a touch-tone phone, or a pulse (rotary) phone with a pocket tone dialer (available through your local RadioShack store) to enter your PIN and do any of the following:

- set the TAD to answer or not answer calls
- listen to your messages
- record a new outgoing message
- record a memo
- erase messages

Note: You cannot remotely operate the TAD-797 using its handset or another telephone on the same line as the TAD.

USING TOLL-SAVER

If **RING TIME** is set to **T/S** (toll-saver, see "Setting the Number of Rings" on Page 14), the TAD-797 answers after about three rings if you have new messages (ones you have not listened to). If there are no new messages, the TAD answers after about five rings. This gives you time to hang up before the TAD answers so you can avoid unnecessary long-distance charges.

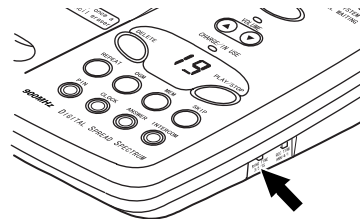

USING REMOTE COMMANDS

Follow these steps to operate the TAD from a remote location.

Notes: If you wait more than 20 seconds between each keypress, the TAD sounds a long beep and hangs up.

1. Dial your phone number and wait for the TAD to answer.

Note: Even if the TAD is not set to answer calls, it will answer after about 10 rings and sound a series of beeps.

2. When the outgoing message begins (or the TAD sounds a series of beeps), press #, then enter your PIN within 2 seconds.

If the PIN is correct, the TAD announces the day and time, then it announces the number of messages. The TAD beeps about once every two seconds to let you know it is ready to accept remote commands.

3. To use a remote command, press # and (within 2 seconds) the number for the command you want.

Press # then:	To:
1	Repeat current message during playback.
2	Play messages.
3	Skip current message during playback.
4	Delete current message during playback.
5	Stop playback, recording, and room monitoring.
6	Set the TAD to answer calls.
7	Record a memo, or stop recording a memo.
8	Record or stop recording a new outgoing message.
9	Set the TAD to not answer calls.
*	Monitor the room where the TAD is located for 15 seconds.

TROUBLESHOOTING

We do not expect you to have any problems with your TAD-797, but if you do, these suggestions might help.

Problem	Suggestion
Low volume or unusual sounds.	Someone has picked up another phone on the same line. Hang up the other phone.
Severe noise interference.	Keep the handset away from computers, remote control toys, wireless microphones, alarm systems, intercoms, room monitors, fluorescent lights, and electrical appliances.
	Move the handset to another location or turn off the source of interference.
The phone cannot be operated at a useful distance from the base because the signal becomes weak or noisy (handset's range has decreased).	Lift the base's antenna to a vertical position.
	Be sure neither antenna is touching a metal surface.
	Return the handset to the cradle, and recharge the battery pack. Replace the battery pack if necessary (see "Replacing the Battery Pack" on Page 37).
The phone does not work or works poorly.	Be sure the base's phone line cord and AC adapter are correctly and securely connected, and the battery pack is charged.
The handset battery pack does not charge.	Check the charging contacts on the handset and base. If they are dirty, clean them with a pencil eraser.
	Be sure the battery pack is connected correctly.
	Replace the battery pack.
The handset does not ring or receive a page.	Move the handset closer to the base.
	Lift the base's antenna to a vertical position.
	The battery pack might be weak. Charge the battery.
	Move the base away from other electrical devices and sources of noise.

Problem	Suggestion
The handset stops working or works poorly during a call.	Move the handset closer to the base.
	Lift the base's antenna to a vertical position.
	Be sure the battery pack is charged. (If the battery power is too low, it does not have enough power to light the display.)
	If the base loses power while the handset is away, the security access-protection code might change. Restore power to the base, then place the handset back on the base. The CHARGE indicator lights, indicating that the code is set again.
	Check the charging contacts on the handset and base. If they are dirty, clean them with a pencil eraser.
The call is too noisy.	Hang up and redial the number.
The TAD does not answer calls.	Make sure the TAD is turned on.
	Make sure the AC adapter and battery pack are properly connected.
	Check all phone line connections.
The TAD does not record callers' messages.	REC TIME is set to ANN (announcement only). Set it to 1 or 4 .
	Delete messages if memory is full.
The handset's display flashes slowly when it is on the base and/or the CHARGE indicator flashes every few seconds.	Be sure the battery pack is correctly connected.
Error appears on the display instead of a Caller ID record.	Occasional errors are normal. If the phone frequently displays Error , contact your local telephone company or RadioShack store for assistance

If you still have problems, disconnect the phone. If other phones on the same line work properly, the fault is in this phone or its installation. If you cannot find the problem, take your phone to your local RadioShack store for assistance.

CARE AND MAINTENANCE

Your TAD-797 Digital Answering System 900MHz Cordless Speakerphone is an example of superior design and craftsmanship. The following suggestions will help you care for your TAD-797 so you can enjoy it for years.



Keep the TAD-797 dry. If it gets wet, wipe it dry immediately. Liquids might contain minerals that can corrode the electronic circuits.



Use and store the TAD-797 only in normal temperature environments. Temperature extremes can shorten the life of electronic devices, damage battery packs, and distort or melt plastic parts.



Keep the TAD-797 away from dust and dirt, which can cause premature wear of parts.



Handle the TAD-797 gently and carefully. Dropping it can damage circuit boards and cases and can cause the TAD-797 to work improperly.



Use only a fresh battery pack of the required size and recommended type. Battery packs can leak chemicals that damage your TAD-797's electronic parts.



Wipe the TAD-797 with a damp cloth occasionally to keep it looking new. Do not use harsh chemicals, cleaning solvents, or strong detergents to clean the TAD-797.

Modifying or tampering with the TAD-797's internal components can cause a malfunction and might invalidate its warranty and void your FCC authorization to operate it. If your TAD-797 is not performing as it should, take it to your local RadioShack store for assistance. If the trouble is affecting the telephone lines, the phone company can ask you to disconnect your TAD-797 until you have resolved the problem.

REPLACING THE BATTERY PACK

If you follow the instructions in "Connecting and Charging the Battery Pack" on Page 12, the battery pack should last about one year. If the battery pack does not hold a charge for more than 2 hours after an overnight charge, replace it with a new 3.6-volt, 600 mAh battery pack with a connector that fits the socket in the battery compartment. You can order a replacement battery pack through your local RadioShack store.

Install the new battery pack as described below, then charge it for about 24 hours.

Note: To avoid losing memory numbers, install and begin charging the new battery pack within 1 minute.

1. Press down and slide off the battery pack compartment cover as shown.

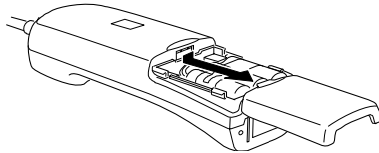

2. Unfasten the plastic retainer strap and lift the battery pack out of the compartment, then gently pull on the battery connector to disconnect it.
3. Insert the new battery pack's connector into the socket in the compartment, place the battery pack into the compartment, and refasten the retainer strap.

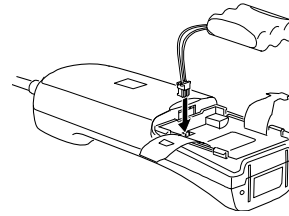

4. Replace the cover.

If you have trouble replacing the battery pack, take the phone to your local RadioShack store for assistance.

Cautions:

- You must use a replacement battery pack of the same size and type.
- Do not dispose of the battery pack in a fire because it might explode.
- Do not open or mutilate the battery pack.
- Be careful not to short the battery pack by touching the connector's pins with conducting materials, such as rings, bracelets, and keys. The battery pack or conductor might overheat and burn.

Important: This product contains a rechargeable nickel-cadmium battery pack. At the end of the battery pack's useful life, it must be recycled or disposed of properly. Contact your local, county, or state hazardous waste management authorities for information on recycling or disposal programs in your area. Some options that might be available are: municipal curb-side collection, drop-off boxes at retailers such as your local RadioShack store, recycling collection centers, and mail-back programs.

THE FCC WANTS YOU TO KNOW

In the unlikely event that your phone causes problems on the phone line, the phone company can temporarily discontinue your service. If this happens, the phone company attempts to notify you in advance. If advance notice is not practical, the phone company notifies you as soon as possible and advises you of your right to file a complaint with the FCC.

Also, the phone company can make changes to its lines, equipment, operations, or procedures that could affect the operation of this telephone. The telephone company notifies you of these changes in advance, so you can take the necessary steps to prevent interruption of your telephone service.

Your phone might cause TV or radio interference even when it is operating properly. To determine whether your phone is causing the interference, turn off your phone. If the interference goes away, your phone is causing it. Try to eliminate the interference by:

- moving your phone away from the receiver
- connecting your phone to an AC outlet that is on a different electrical circuit from the receiver
- contacting your local RadioShack store for help

If you cannot eliminate the interference, the FCC requires that you stop using your phone.

Some cordless telephones operate on frequencies that might cause interference to nearby TVs and VCRs. To minimize or prevent such interference, the base of the cordless telephone should not be placed near or on top of a TV or VCR.

LIGHTNING

Your telephone has built-in lightning protection to reduce the risk of damage from surges in telephone line and power line current. This lightning protection meets or exceeds FCC requirements. However, lightning striking the telephone or power lines can damage your telephone.

Lightning damage is not common. Nevertheless, if you live in an area that has severe electrical storms, we suggest that you unplug your phone during storms to reduce the possibility of damage.



NOTES

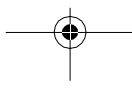
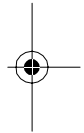
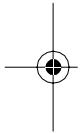



Limited One-Year Warranty

This product is warranted by RadioShack against manufacturing defects in material and workmanship under normal use for one (1) year from the date of purchase from RadioShack company-owned stores and authorized RadioShack franchisees and dealers. EXCEPT AS PROVIDED HEREIN, RadioShack MAKES NO EXPRESS WARRANTIES AND ANY IMPLIED WARRANTIES, INCLUDING THOSE OF MERCHANTABILITY AND FITNESS FOR A PARTICULAR PURPOSE, ARE LIMITED IN DURATION TO THE DURATION OF THE WRITTEN LIMITED WARRANTIES CONTAINED HEREIN. EXCEPT AS PROVIDED HEREIN, RadioShack SHALL HAVE NO LIABILITY OR RESPONSIBILITY TO CUSTOMER OR ANY OTHER PERSON OR ENTITY WITH RESPECT TO ANY LIABILITY, LOSS OR DAMAGE CAUSED DIRECTLY OR INDIRECTLY BY USE OR PERFORMANCE OF THE PRODUCT OR ARISING OUT OF ANY BREACH OF THIS WARRANTY, INCLUDING, BUT NOT LIMITED TO, ANY DAMAGES RESULTING FROM INCONVENIENCE, LOSS OF TIME, DATA, PROPERTY, REVENUE, OR PROFIT OR ANY INDIRECT, SPECIAL, INCIDENTAL, OR CONSEQUENTIAL DAMAGES, EVEN IF RadioShack HAS BEEN ADVISED OF THE POSSIBILITY OF SUCH DAMAGES.

Some states do not allow the limitations on how long an implied warranty lasts or the exclusion of incidental or consequential damages, so the above limitations or exclusions may not apply to you.

In the event of a product defect during the warranty period, take the product and the RadioShack sales receipt as proof of purchase date to any RadioShack store. RadioShack will, at its option, unless otherwise provided by law: (a) correct the defect by product repair without charge for parts and labor; (b) replace the product with one of the same or similar design; or (c) refund the purchase price. All replaced parts and products, and products on which a refund is made, become the property of RadioShack. New or reconditioned parts and products may be used in the performance of warranty service. Repaired or replaced parts and products are warranted for the remainder of the original warranty period. You will be charged for repair or replacement of the product made after the expiration of the warranty period.

This warranty does not cover: (a) damage or failure caused by or attributable to acts of God, abuse, accident, misuse, improper or abnormal usage, failure to follow instructions, improper installation or maintenance, alteration, lightning or other incidence of excess voltage or current; (b) any repairs other than those provided by a RadioShack Authorized Service Facility; (c) consumables such as fuses or batteries; (d) cosmetic damage; (e) transportation, shipping or insurance costs; or (f) costs of product removal, installation, set-up service adjustment or reinstallation.

This warranty gives you specific legal rights, and you may also have other rights which vary from state to state.

RadioShack Customer Relations, Dept. W, 100 Throckmorton St., Suite 600, Fort Worth, TX 76102

We Service What We Sell

3/97



RadioShack
A Division of Tandy Corporation
Fort Worth, Texas 76102

09A98

UCZZ01609ZZ
Printed in the Philippines

