

SAMSUNG

**OWNER'S INSTRUCTIONS &
INSTALLATION MANUAL
MANUAL DE INSTRUCCIONES &
MANUAL DE INSTALACIÓN
MANUEL D'UTILISATION &
MANUEL D'INSTALLATION**

**Indoor Unit
AM18B1C09
AM26B1C13
AM27B1C07
AM27B1C13**

**Outdoor Unit
UM18B1C2
UM26B1C2
UM27B1C3**

ENGLISH

ESPAÑOL

FRANÇAIS

**MULTI-SPLIT TYPE ROOM AIR CONDITIONER (Cool)
ACONDICIONADOR DE AIRE DOMÉSTICO SISTEMA MULTI SPLIT (Refrigeración)
CLIMATISEUR DE TYPE MULTIPLE (Refroidissement)**

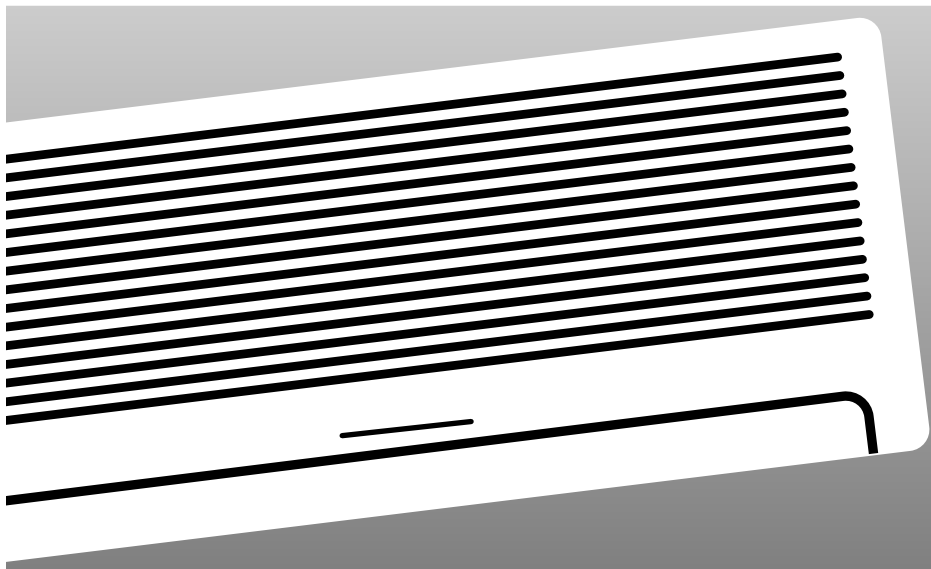

Safety Precautions

The following safety precautions must be taken when using your air conditioner.

- 1 *Make sure that the indoor unit is correctly ventilated at all times; do NOT place clothing or other materials over it.*
- 2 *NEVER spill liquid of any kind into the indoor unit. Should this happen, switch off the breaker used for your air conditioner and contact your installation specialist.*
- 3 *Do NOT insert anything between the air flow blades, as the inner fan may become damaged and you may be hurt. Keep children away from the indoor unit.*
- 4 *Do NOT place any obstacles in front of the outdoor unit.*
- 5 *If the remote control will not be used for a long time, remove the batteries.*
- 6 *Users of this product are cautioned not to attempt repair of this product at their own discretion. Instead, they are requested to directly contact a designated service center or the outlet at which the product was purchased.*
- 7 *If the supply cord is damaged, it must be replaced by a special cord or assembly available from the manufacturer or its service centre.*
- 8 *This device must be installed according to the national electrical rules.*
- 9 *Before disposing of the remote control it is necessary to remove batteries.*
- 10 *The appliance is not intended for use by young children or infirm person without supervision; young children should be supervised to ensure that they do not play with the appliance.*
- 11 *Max current is measured according to IEC standard for safety and current is measured according to ISO standard for energy efficiency.*

CAUTION

The manufacturer does not take any responsibility for any accidents that occur because the air conditioner is not fixed firmly or installed securely, during installing or using the product. In case you experience difficulty in installation, you must use an installation specialist. An accident will occur if the installation is not done as recommends in the installation guide.

Contents

◆	PREPARING YOUR AIR CONDITIONER	
■	Safety Precautions	2
■	View of the Unit	4
■	Remote Control-Buttons and Display	6
■	Getting Started	7
■	Inserting the Remote Control Batteries	8
■	Installing the Remote Controller Holder	8
◆	OPERATING YOUR AIR CONDITIONER	
■	5 Way Function	9
■	Selecting the Automatic Operating Mode	10
■	Cooling Your Room	11
■	Changing the Room Temperature Quickly	12
■	Removing Excess Humidity	13
■	Airing Your Room	14
■	Adjusting the Air Flow Direction Vertically	15
■	Adjusting the Air Flow Direction Horizontally	15
◆	PROGRAMMING YOUR AIR CONDITIONER	
■	Setting the On Timer	16
■	Setting the Off Timer	17
■	Setting the Sleep Timer	18
◆	RECOMMENDATIONS FOR USE	
■	Operating Recommendations	19
■	Temperature and Humidity Ranges	20
■	Cleaning Your Air Conditioner	21
■	Solving Common Problems	22
■	Installing a Filter (Option)	23
◆	TECHNICAL SPECIFICATIONS	

View of the Unit

The design and shape are subject to change according to the model.

Indoor Unit

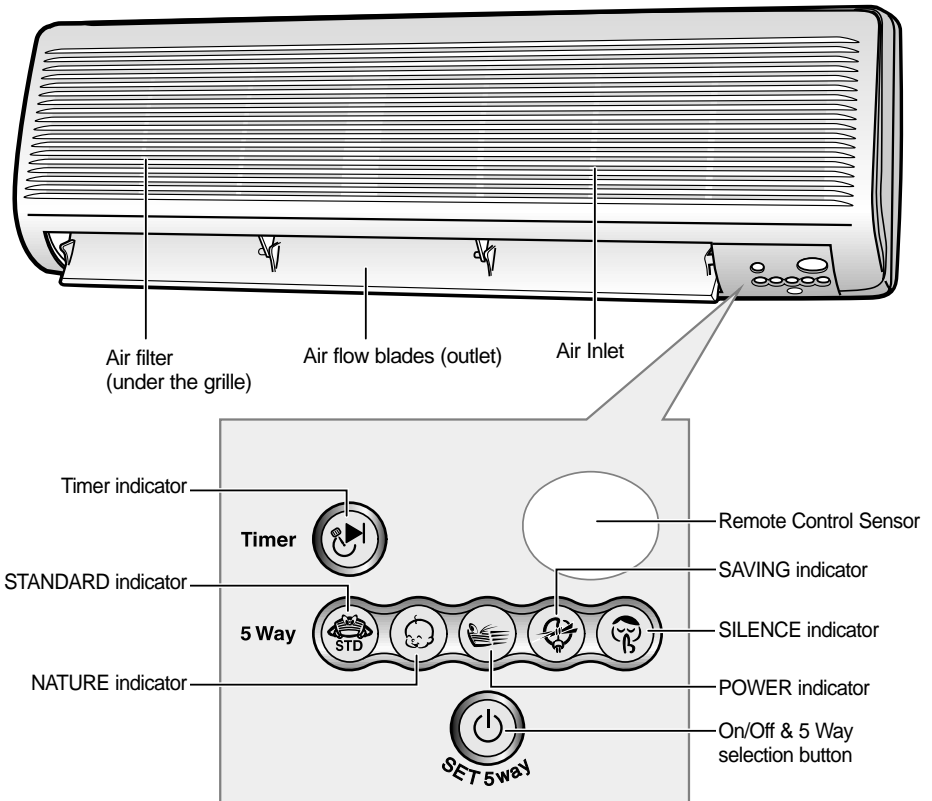

Note ◆ For details on the 5 Way, refer to page 9.

Outdoor Unit UM18B1C2

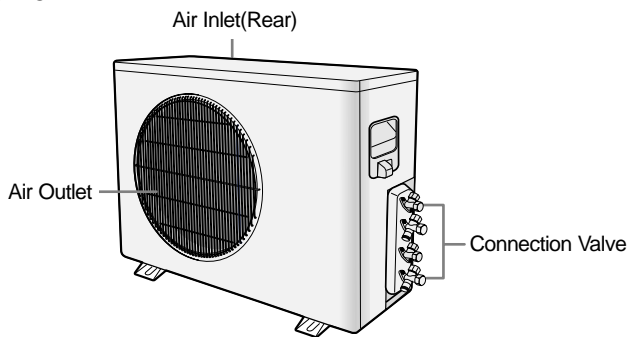

Outdoor Unit UM26B1C2

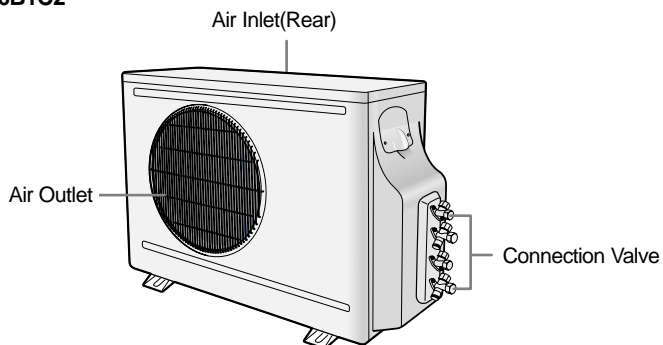

Outdoor Unit UM27B1C3

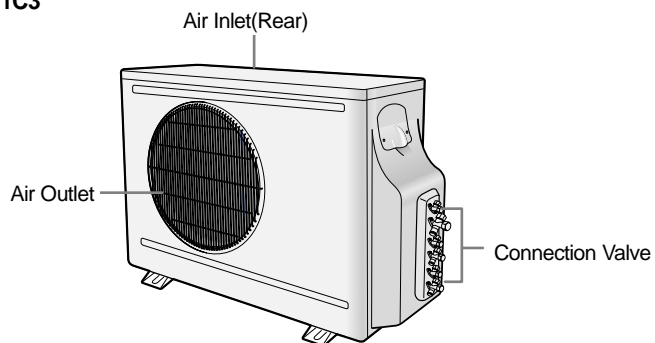

Remote Control - Buttons and Display

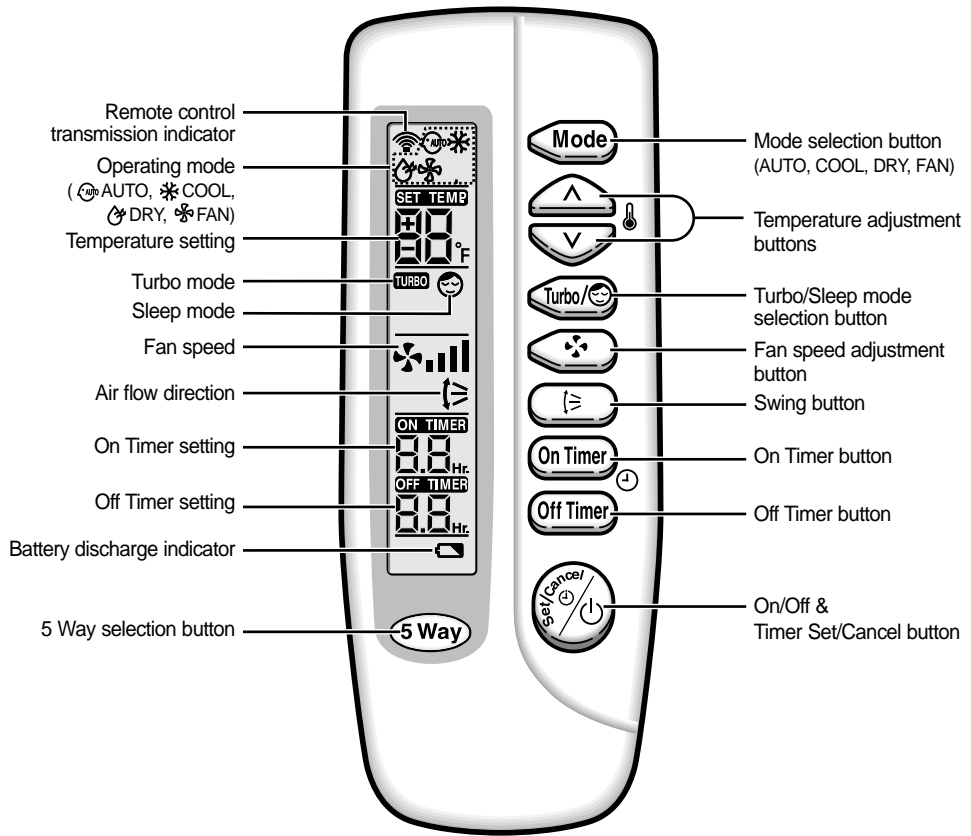

Getting Started

You have just purchased a split type air conditioner and it has been installed by your installation specialist.

Your Owner's Instructions contains valuable information on using your air conditioner. Please take the time to read it as it will help you take full advantage of the unit's features.

The booklet is organized as follows.

- ◆ *The following figures are shown on pages from 4 to 6 :*
 - *Indoor and outdoor units*
 - *Remote control(buttons and display)**They will help you find the buttons and understand the symbols displayed.*

- ◆ *In the main part of the installation book, you will find a series of step-by-step procedures for each function available.*

The illustrations in the step-by-step procedures use three different symbols:

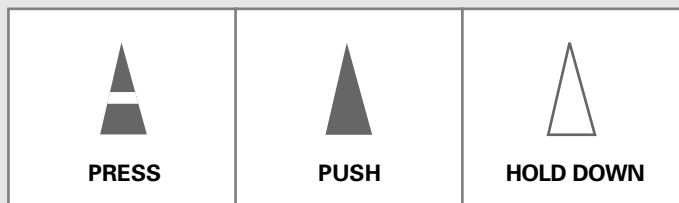

Inserting the Remote Control Batteries

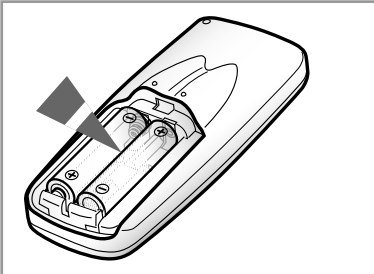
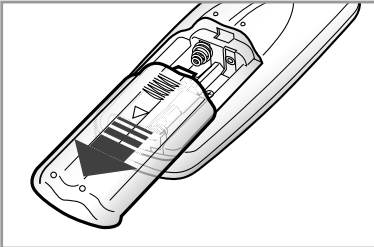

You must insert or replace the remote control batteries when :

- ◆ **You purchase the air conditioner**
- ◆ **The remote control does not work correctly**

Note

- ◆ Use two AAA, LR03 1.5V batteries.
- ◆ Do not use old batteries or different kinds of batteries together.
- ◆ Batteries may be completely discharged after 12 months, even if they have not actually been used.

- 1 Push the battery cover on the rear of the remote control with your thumb in the direction of the arrow and remove it.
- 2 Insert the two batteries, taking care to respect the polarities :
 - ◆ + on the battery with + on the remote control.
 - ◆ - on the battery with - on the remote control.
- 3 Close the cover by sliding it back until it clicks into place.

Installing the Remote Controller Holder

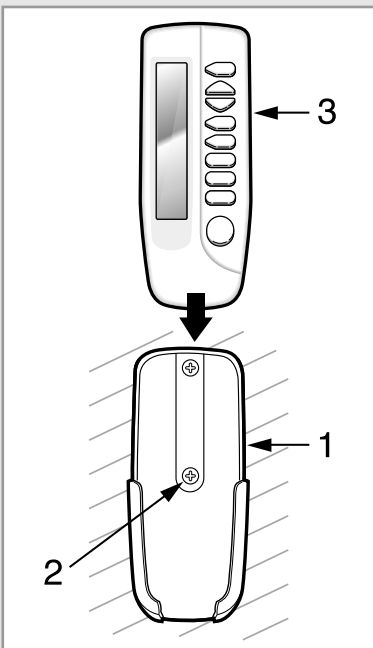







- 1 Place the remote controller holder on the wall.
- 2 Fix the remote controller holder by tightening the screws.
- 3 Put the remote controller into the holder as shown in the figure.
 - ◆ If you want to install the holder easily, you had better install the holder on the wooden frame.

5 Way Function

You can select the 5 Way function with operating mode of the air conditioner for more comfortable circumstances. You can use the 5 Way function with the indoor unit as well as the remote control. Thus, you can use this function even though you have lost your remote control.

Using with the indoor unit

- 1 Press the  (ON/OFF) button one time and then select the desired mode.

To obtain a(n)...	Then select...
Normal operating	 (STANDARD) mode
Reducing the uncomfortable temperature gradually	 (NATURE) mode
High fan speed	 (POWER) mode
Compressor run time reduced	 (SAVING) mode
Fan speed reduces as the temperature decreases	 (SILENCE) mode

- 2 To stop the operating, press the  (ON/OFF) button until all indicators turn off.

Note Even if the air conditioner has been turned on via the ON/OFF button on the unit, operations can still be controlled using the remote control as usual.

Selecting with the Remote Control

To select the 5 Way function with the remote control, press the 5 Way button one or more times until the desired mode is selected.

- ◆ Each time you press the 5 Way button:



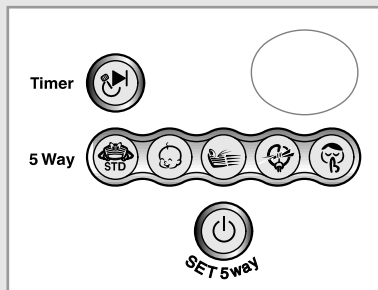

Each 5 Way indicator on the indoor unit lights up in order.

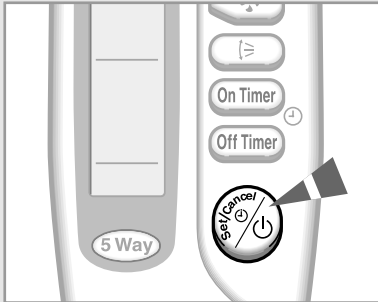

Selecting the Automatic Operating Mode

You can start the air conditioner in Automatic mode from your remote control. In the Automatic mode, the standard temperature and the optimum fan speed is selected automatically. You can adjust the standard temperature but not the fan speed.



- 1 If necessary, press the  (On/Off) button.

Result:

- ◆ The 5 Way indicator on the indoor unit lights up.
- ◆ The air conditioner starts up in the mode selected when the unit was last used.
- ◆ The indoor unit beeps.

IMPORTANT The air conditioner is fitted with a protection mechanism to prevent the unit from being damaged when it is started immediately after being:

- ◆ Plugged in
 - ◆ Stopped
- It will start up normally after three minutes.

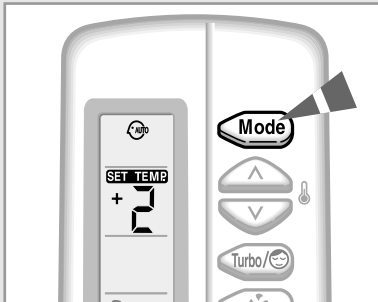

- 2 If the  is not displayed at the top of the remote control, press the MODE button on the remote control one or more times until it appears.

Result:

- ◆ The indoor unit beeps each time you press the MODE button.
- ◆ The air conditioner runs in AUTO mode.

Note You can change modes at any time.

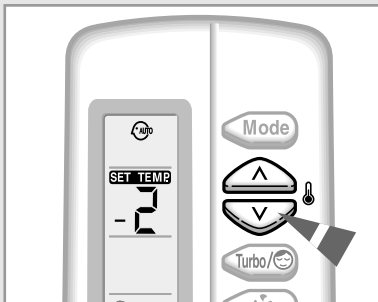

- 3 To adjust the standard temperature (The air conditioner automatically set the standard temperature by the current room temperature.), press the TEMPERATURE buttons one or more times.

SET TEMP.	SET TEMP.	-	SET TEMP.	SET TEMP.
-4°F/-2°C	-2°F/-1°C	Standard temperature	+2°F/+1°C	+4°F/+2°C
< When you feel hot >			< When you feel chilly >	

Cooling Your Room

You must select the Cool mode if you wish to adjust the:

- ◆ Cooling temperature
- ◆ Fan speed when cooling

1 If necessary, press the  (On/Off) button.

- Result:**
- ◆ The 5 Way indicator on the indoor unit lights up.
 - ◆ The air conditioner starts up in the mode selected when the unit was last used.
 - ◆ The indoor unit beeps.

IMPORTANT The air conditioner is fitted with a protection mechanism to prevent the unit from being damaged when it is started immediately after being:

- ◆ Plugged in
- ◆ Stopped

It will start up normally after three minutes.

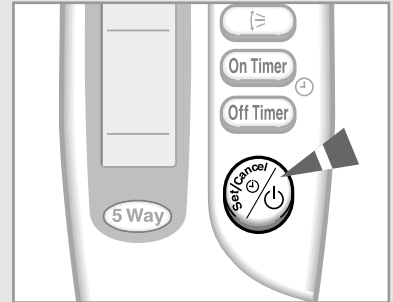

2 If the  is not displayed at the top of the remote control, press the MODE button on the remote control one or more times until it appears.

- Result:**
- ◆ The indoor unit beeps each time you press the MODE button.
 - ◆ The air conditioner runs in COOL mode.

Note You can change modes at any time.

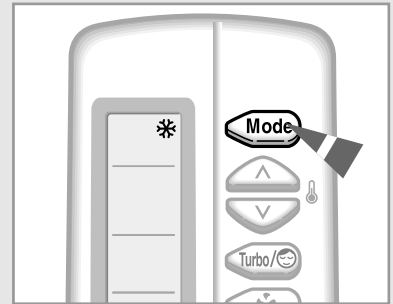



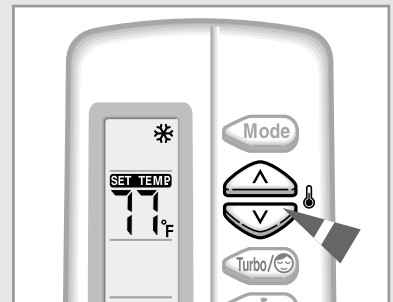

3 To adjust the temperature, press the TEMPERATURE buttons one or more times until the required temperature is displayed. Possible temperatures are between 65°F(18°C) and 86°F(30°C) inclusive.

- Result:**
- ◆ Each time you press the TEMPERATURE buttons:
 - The temperature is adjusted by 1°F(1°C)
 - The indoor unit beeps
 - ◆ The air conditioner starts cooling, provided that the room temperature is higher than the selected temperature; the fan will, however, operate.

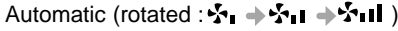

4 Select the fan speed by pressing the FAN button one or more times until the required setting is displayed:

-  Automatic (rotated : )
-  Low
-  Medium
-  High

Result: Each time you press the FAN button, the indoor unit beeps.

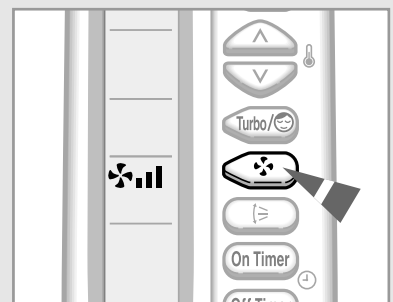

5 To control the direction of the air flow, refer to page 15.

Changing the Room Temperature Quickly

The Turbo cooling function is used to cool your room as quickly as possible.

Example : You have just come home and find that the room is very hot. You wish to cool it down as quickly as possible.

The Turbo function operates for 30 minutes with the maximum settings before returning automatically to the mode and temperature previously selected.

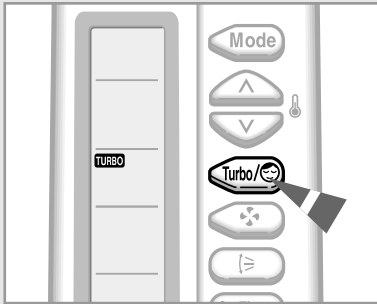

1 If necessary, press the  (On/Off) button.

Result:



- ◆ The 5 Way indicator on the indoor unit lights up.
- ◆ The air conditioner starts up in the mode selected when the unit was last used.
- ◆ The indoor unit beeps.

2 Press the  button.

Result:

- ◆ The temperature and fan settings are adjusted automatically.
- ◆ The air conditioner cools the room as quickly as possible.
- ◆ After 30 minutes, the air conditioner is reset automatically to the previous mode, temperature and fan settings.

But, if you press the  button in DRY or FAN mode, it will change to AUTO mode automatically.

3 If you wish to stop the Turbo function before the end of the 30-minute period, press the  button one or more times until **TURBO** or  disappears.

Result: The air conditioner is reset automatically to the previous mode, temperature and fan settings.

4 To control the direction of the air flow, refer to page 15.

Removing Excess Humidity

If the atmosphere in your room is very humid or damp, you can remove excess humidity without lowering the room temperature too much.

- 1 If necessary, press the  (On/Off) button.

Result:

- ◆ The 5 Way indicator on the indoor unit lights up.
- ◆ The air conditioner starts up in the mode selected when the unit was last used.
- ◆ The indoor unit beeps.

IMPORTANT The air conditioner is fitted with a protection mechanism to prevent the unit from being damaged when it is started immediately after being:

- ◆ Plugged in
- ◆ Stopped

It will start up normally after three minutes.

- 2 If the  is not displayed at the top of the remote control, press the MODE button on the remote control one or more times until it appears.

Result:

- ◆ The indoor unit beeps each time you press the MODE button.
- ◆ The air conditioner runs in DRY mode.

Note You can change modes at any time.

- 3 To adjust the temperature, press the TEMPERATURE buttons one or more times until the required temperature is displayed. Possible temperatures are between 65°F(18°C) and 86°F(30°C) inclusive.

Result:

- ◆ Each time you press the TEMPERATURE buttons:
 - The temperature is adjusted by 1°F(1°C)
 - The indoor unit beeps
- ◆ The air conditioner starts removing the excess humidity; the quantity of air is adjusted automatically.

- 4 To control the direction of the air flow, refer to page 15.

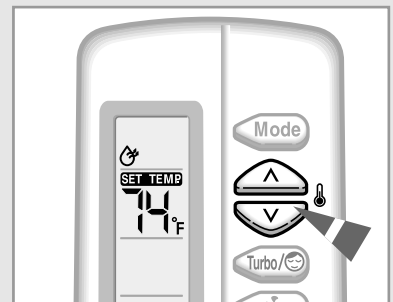
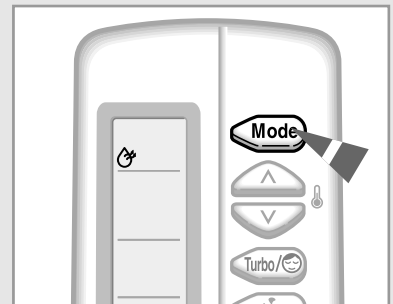
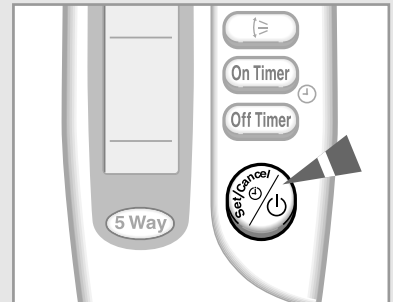

Airing Your Room

If the atmosphere in your room is stale, you can air the room using the Fan feature.

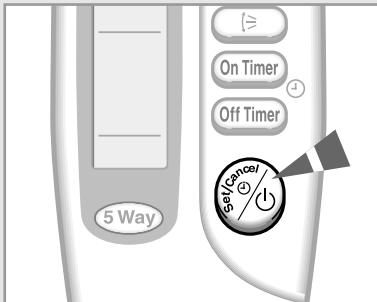

- 1 If necessary, press the  (On/Off) button.

Result:

- ◆ The 5 Way indicator on the indoor unit lights up.
- ◆ The air conditioner starts up in the mode selected when the unit was last used.
- ◆ The indoor unit beeps.

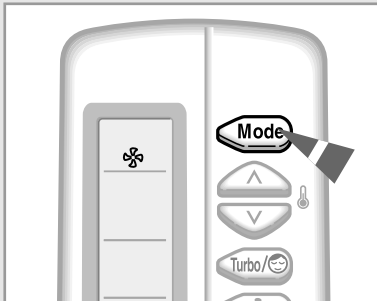

- 2 If the  is not displayed at the top of the remote control, press the MODE button on the remote control one or more times until it appears.



Result:

- ◆ The indoor unit beeps each time you press the MODE button.
- ◆ The air conditioner runs in FAN mode.
- ◆ The temperature is set automatically.

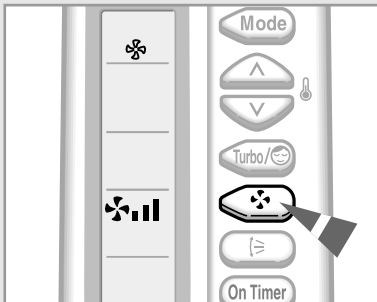
Note You can change modes at any time.



- 3 Select the fan speed by pressing the FAN button one or more times until the required setting is displayed:

-  Low
-  Medium
-  High

Result: Each time you press the FAN button, the indoor unit beeps.

- 4 To control the direction of the air flow, refer to page 15.

Adjusting the Air Flow Direction Vertically

Depending on the position of the indoor unit on the wall of your room, you can adjust the position of the outer air flow blade on the bottom of the unit, thus increasing the efficiency of the air conditioner.

- 1 Press the SWING button one or more times as required.

Result: The outer blade is adjusted vertically.

RECOMMENDATION	When...	Adjust the blade to face...
	Cooling	Upwards.

- 2 If you want the blade to move up and down automatically when the air conditioner is operating, press the SWING button.

Result: The blade move up and down, around the base position set.

- 3 To stop the blade moving up and down, press the SWING button again.

Note *If you switch the air conditioner... Then the blade is...*

Off	Closed completely.
On again	Set to the initial position powered.

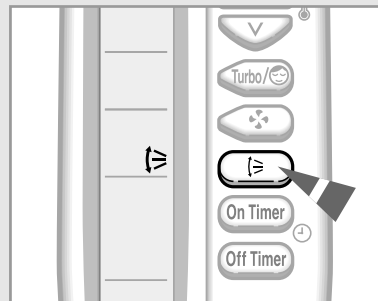

Adjusting the Air Flow Direction Horizontally

There are two sets of inner air flow blades. Just as the outer air flow blade can be adjusted vertically, the inner blades can be adjusted horizontally.

- 1 Adjust each set of inner blades to the required position, by pushing or pulling them sideways.

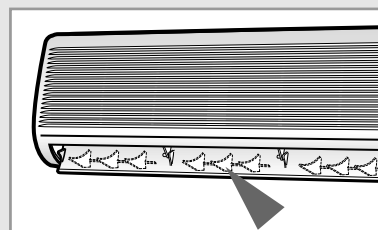

Setting the On Timer

The On Timer enables you to switch on the air conditioner automatically after a given period of time. You can set the period of time from 30 minutes to 24 hours.

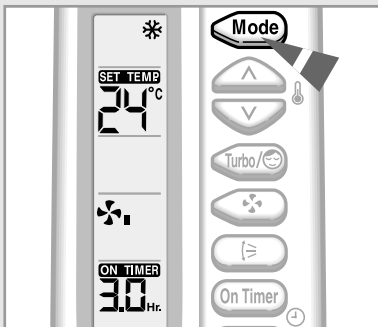
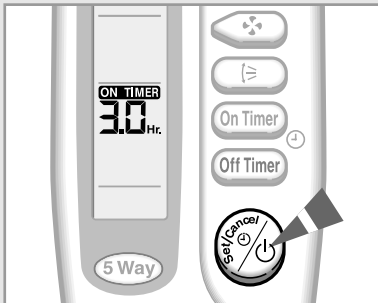

1 To set the operating time, press the ON TIMER button one or more times until the required time is displayed. Possible time is between 0.5 hour and 24 hour inclusive.

2 Press the  (Set/Cancel) button to complete the setting.

Result:

- ◆ The remaining time is displayed.
- ◆ Blinking of the timer indicator stops.
- ◆ The selected mode and the temperature on the display disappear after 10 seconds.
- ◆ The air conditioner will switch on automatically when the counter displayed on the remote control reaches the set time and disappears the On timer setting.

3 To select an operating mode in advance, press the  button until the desired mode is displayed at the top of the remote control.

Result:

- ◆ The air conditioner will run in the selected mode when it is turned on.

To Cancel the On Timer

1 To cancel the On Timer, press the ON TIMER button one or more times until the timer setting disappears.

2 Press the  (Set/Cancel) button.

Note

If you want to turn on the air conditioner before the timer reaches the setting time, press the  (ON/OFF) button.

Setting the Off Timer

The Off Timer enables you to switch off the air conditioner automatically after a given period of time. You can set the period of time from 30 minutes to 24 hours.



1 To set the operating time, press the OFF TIMER button one or more times until the required time is displayed. Possible time is between 0.5 hour and 24 hour inclusive.

2 Press the  (Set/Cancel) button to complete the setting.

Result:

- ◆ The remaining time is displayed.
- ◆ Blinking of the timer indicator stops.
- ◆ The air conditioner will switch off automatically when the counter displayed on the remote control reaches the set time and disappears the Off timer setting.

Example If you would like to turn the air conditioner on after 2 hours and to operate it for 2 hours:

1. Press the ON TIMER button until '2.0 Hr' is displayed.
2. Press the  (Set/Cancel) button.
3. Press the OFF TIMER button until '4.0 Hr' is displayed.
4. Press the  (Set/Cancel) button.

Note You can see or change the setting mode and/or the temperature by pressing the MODE button or the TEMPERATURE buttons after setting the Off timer.

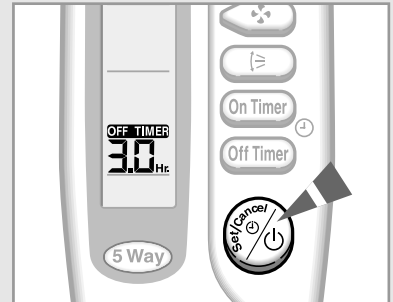
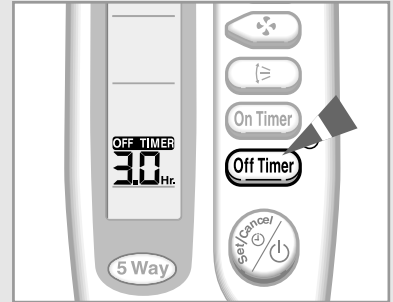

To Cancel the Off Timer

1 To cancel the Off Timer, press the OFF TIMER button one or more times until the timer setting disappears.

2 Press the  (Set/Cancel) button.

Note If you want to turn off the air conditioner before the timer reaches the setting time, press the  (ON/OFF) button.

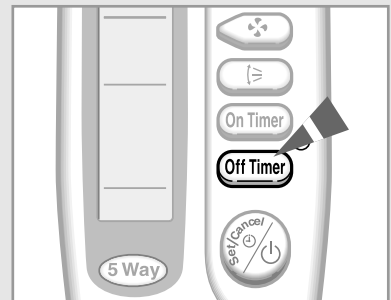

Setting the Sleep Timer

The Sleep Timer can be used when you are cooling your room to switch the air conditioner off automatically after a period of six hours.

Note If you wish to switch the unit off at a specific time, refer to page 17.

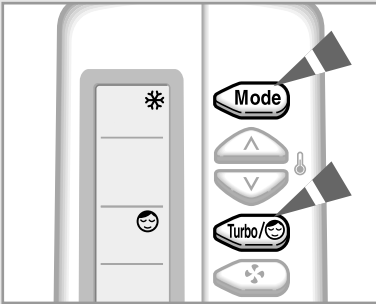

- 1 Make sure that you have selected either COOL mode.
- 2 Press the button one or more times until appears on the remote control.

Result:

- ◆ The indoor unit beeps.
- ◆ The air conditioner will be controlled as indicated in the illustrations below.

Cooling The desired temperature is increased by 2°F/1°C every hour. When it has been increased by 4°F/2°C (after two hours), the temperature is maintained for four hours.

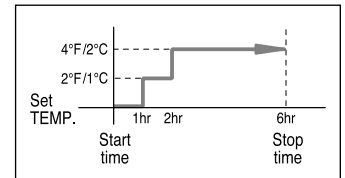

To Cancel the Sleep Timer

If you no longer wish to use the Sleep Timer that you have set, you can cancel it at any time.

Press the button.

Result:

- ◆ The indoor unit beeps.
- ◆ The is no longer displayed.
- ◆ The air conditioner operates normally.

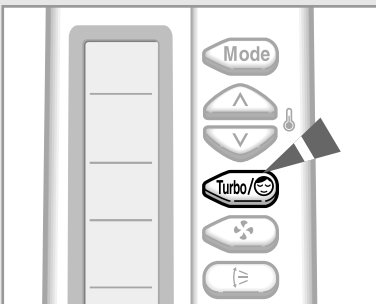

Operating Recommendations

Here are a few recommendations that you should follow when using your air conditioner.

Topic	Recommendation
Power failure	If a power failure occurs when the air conditioner is operating, the unit is switched off. When the power returns, you must press the  (ON/OFF) button to restart it.

Temperature and Humidity Ranges

The following table indicates the temperature and humidity ranges within which the air conditioner can be used.

If the air conditioner is used at...	Then...
High temperatures	The automatic protection feature may be triggered and the air conditioner stopped.
Low temperatures	A water leak or some other malfunction may occur if the heat exchanger freezes.
High humidity levels	Water may condense on and drip from the surface of the indoor unit if it is used for long periods.

Mode	Outdoor Temperature	Indoor Temperature	Indoor Humidity
Cooling	70°F to 109°F approx. 21°C to 43°C approx.	65°F to 90°F approx. 18°C to 32°C approx.	80% or less
Drying	65°F to 109°F approx. 18°C to 43°C approx.	65°F to 90°F approx. 18°C to 32°C approx.	-

* ***If the cooling operation is used at over 92°F/33°C(indoor temperature) then, it does not cool as its full capacity.***

Cleaning Your Air Conditioner

To get the best possible use out of your air conditioner, you must clean it regularly to remove the dust that accumulates on the air filter.

IMPORTANT Before cleaning your air conditioner, ensure that you have switched off the breaker used for the unit.

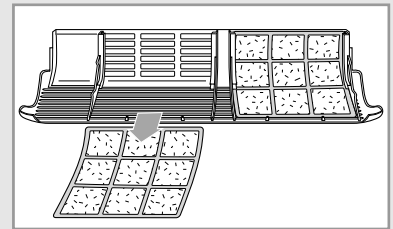
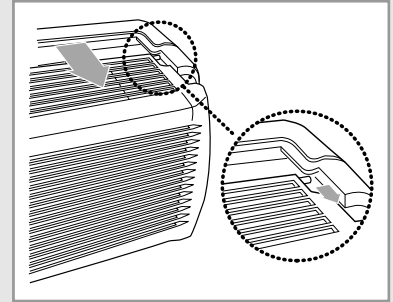

- 1 Open the front grille by lifting the tabs on the lower right and left sides of the indoor unit.
- 2 Disassemble the front grille by pulling it forwards.
- 3 Hold the edge of the air filter under the front grille and pull to release them.
- 4 Remove all dust on the air filters with a vacuum cleaner or brush.
- 5 Clean the front panel with a damp cloth and mild detergent (do NOT use benzene, solvents or other chemicals).
- 6 Reassemble the air filters and the front grille.

Note ♦ **If you have not used the air conditioner for a long period of time, set the fan going for three to four hours to dry the inside of the air conditioner thoroughly.**



Solving Common Problems

Before contacting the after-sales service, perform the following simple checks. They may save you the time and expense of an unnecessary call.

Problem	Explanation/Solution
The air conditioner does not operate at all	<ul style="list-style-type: none"> ◆ Check that the breaker used for the air conditioner is switched on. ◆ Check that the 5 Way indicator on the indoor unit is on; if necessary press the  (On/Off) button on the remote control. ◆ Check whether the TIMER indicator on the indoor unit is switched on. If so: <ul style="list-style-type: none"> - Wait until the switch-on time is reached and the air conditioner starts up automatically - Cancel the timer (see pages 16 and 17 for further details)
The air conditioner does not operate with the remote control	<ul style="list-style-type: none"> ◆ Check that there are no obstacles between you and the indoor unit. ◆ Check the remote control batteries. ◆ Check that you are close enough to the indoor unit (seven metres/yards/23ft. or less).
No beep is heard when you press the  (On/Off) on the remote control	<ul style="list-style-type: none"> ◆ Check that you are pointing the remote control at the remote control sensor in the right of the indoor unit. ◆ Replace the remote control batteries if necessary.
The air conditioner does not cool	<ul style="list-style-type: none"> ◆ Check that the correct operating mode has been selected (AUTO, COOL). ◆ The room temperature may be too low or too high. ◆ Dust may be blocking the air filter guard; refer to page 21 for cleaning instructions. ◆ Check that there is no obstacle in front of the outdoor unit.
The fan speed does not change when you press the FAN button	<ul style="list-style-type: none"> ◆ Check that the operating mode is set to COOL or FAN ; in the AUTO mode, the fan speed changes automatically and in the DRY mode, it is set to AUTO.
The air flow direction does not change when you press the SWING button	<ul style="list-style-type: none"> ◆ Check that the air conditioner has been switched on; if necessary, press the  (On/Off) button on the remote control.
The timer is not correctly triggered	<ul style="list-style-type: none"> ◆ Check that the timer has been programmed correctly; see pages 16 and 17.
Odours are permeated in the room during air conditioning	<ul style="list-style-type: none"> ◆ Air the room.

Installing a Filter (Option)

The air conditioner can be fitted with a deodorizing and Bio-Pure filter to remove minute dust particles or odours. The service life of the filter is approximately three months depending on the time during which the air conditioner is used.

- 1 Remove the vinyl packing from the filter.

Note Do not remove the packing from a deodorizing filter until you wish to use the filter, as it will lose its properties.

- 2 Insert the filter in the filter holder and press the three insert tabs until you hear a click.

- 3 Open the front grille by pulling on the tabs on the lower right and left sides of the indoor unit.

- 4 Take out the existing filter and replace it with the new one.

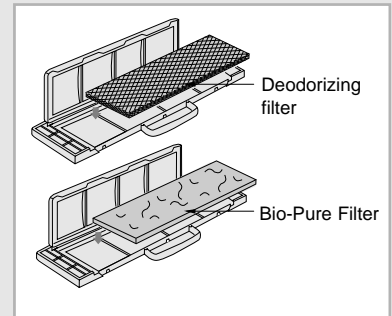

Technical Specifications

MODEL			Indoor unit	Outdoor unit	Indoor unit	Outdoor unit
			AM18B1C09	UM18B1C2	AM26B1C13	UM26B1C2
Type			2 Comp + 2 Room		2 Comp + 2 Room	
Performance Ratings	Capacity Cooling	Btu/h	A/B-Unit : 9000		A/B-Unit : 12500	
	SEER		10.0		10.0	
	Moisture Removal	Pts/h	3	-	4	-
	Air FLOW(Cooling, HIGH)	CFM	255	-	300	-
	Sound Rating-Outdoor	dB	-	57	-	60
Electrical Data	The number of operation		1 Unit operation	2 Unit operation	1 Unit operation	2 Unit operation
	Power source		208-230V~,60Hz		208-230V~,60Hz	
	Min.Ampacity	A	4.3	8.4	6.1	11.4
	Cooling Watts	W	990	1920	1360	2550
Refrigeration Lines	Indoor unit		A-Unit	B-Unit	A-Unit	B-Unit
	Connections		Flare		Flare	
	Liquid Line O. D.	mm(in)	6.35 (1/4)		6.35 (1/4)	
	Suction Line O.D.	mm(in)	9.52 (3/8)		12.70 (1/2)	
	Factory Pre-charge	m(ft)	5.0 (16½)		5.0 (16½)	
	Max. Line length	m(ft)	15.0 (49¼)		15.0 (49¼)	
	Max. Height Difference	m(ft)	7.0 (23)		7.0 (23)	
Dimensions & Weight	W X H X D	mm(in)	790 x 245 x 165 (31⅛ x 9½ x 6½)	880 x 638 x 310 (34½ x 25⅛ x 12¼)	790 x 245 x 165 (31⅛ x 9½ x 6½)	1000 x 790 x 310 (39½ x 31⅛ x 12¼)
	Net Weight	lbs	17	132.3	17	152.1

* Standard rating conditions Cooling

	Indoor		Outdoor	
	DB	WB	DB	WB
°F	80	67	95	75
°C	26.7	19.4	35.0	23.9

MODEL			Indoor unit	Indoor unit	Outdoor unit
			AM27B1C07	AM27B1C13	UM27B1C3
Type			2 Comp + 3 Room		
Performance Ratings	Capacity Cooling	Btu/h	A-Unit : 13000, B/C-Unit : 7000		
	SEER		10.0		
	Moisture Removal	Pts/h	2.5	4	-
	Air FLOW(Cooling, HIGH)	CFM	220	300	-
	Sound Rating-Outdoor	dB	-	-	62
Electrical Data	The number of operation		1 Unit operation	2 Unit operation	3 Unit operation
	Power source		208-230V~,60Hz		
	Min.Ampacity	A	A : 6.0, B(C) : 5.8	A+B(C) : 11.0, B+C : 6.2	A+B+C : 11.6
	Cooling Watts	W	A : 1350, B(C) : 1300	A+B(C) : 2450, B+C : 1380	A+B+C : 2580
Refrigeration Lines	Indoor unit		A-Unit	B-Unit	C-Unit
	Connections		Flare		
	Liquid Line O. D.	mm(in)	6.35 (1/4)		
	Suction Line O.D.	mm(in)	12.70(1/2)	9.52 (3/8)	
	Factory Pre-charge	m(ft)	5.0 (16 $\frac{1}{2}$)		
	Max. Line length	m(ft)	15.0 (49 $\frac{1}{4}$)		
	Max. Height Difference	m(ft)	7.0 (23)		
Dimensions & Weight	W X H X D	mm(in)	790 x 245 x 165 (31 $\frac{1}{8}$ x 9 $\frac{1}{2}$ x 6 $\frac{1}{2}$)		1000 x 790 x 310 (39 $\frac{1}{2}$ x 31 $\frac{1}{8}$ x 12 $\frac{1}{4}$)
	Net Weight	lbs	17		154.3