

# MINOLTA

# *VECTIS* S-1

**E**

**INSTRUCTION  
MANUAL**



**BASIC  
OPERATION**

**FOCUS**

**USING THE  
BUILT-IN  
FLASH**

**SUBJECT  
PROGRAM  
MODES**

**CREATIVE  
EXPOSURE  
MODES**

**ADDITIONAL  
FEATURES**

**APPENDIX**

Thank you for purchasing the Minolta Vectis S-1. The Vectis S-1 is an ultra compact IX240 type system camera with many Advanced Photo System™ features such as variable print-aspect-ratio and magnetic storage of date, title, and exposure information. The Vectis S-1 also incorporates the revolutionary TTL side viewfinder. The side viewfinder provides a high viewfinder magnification, high eyepoint, and large diopter range, in addition to giving the camera its distinctive profile.

This manual has been designed to help you understand the operation of your camera and its functions. Please familiarize yourself with the names of the controls and their locations on the camera, then read this manual thoroughly. Use the Quick Reference in the back of the manual as a guide when taking pictures.

- Advanced Photo System™ is a trademark of the five system developing companies, including Minolta.

This device complies with Part 15 of the FCC Rules. Operation is subject to the following two conditions: (1) This device may not cause harmful interference, and (2) this device must accept any interference received, including interference that may cause undesired operation. Changes or modifications not approved by the party responsible for compliance could void the user's authority to operate the equipment. This equipment has been tested and found to comply with the limits for a Class B digital device, pursuant to Part 15 of the FCC Rules. These limits are designed to provide reasonable protection against harmful interference in a residential installation. This equipment generates, uses and can radiate radio frequency energy and, if not installed and used in accordance with the instructions, may cause harmful interference to radio communications. However, there is no guarantee that interference will not occur in a particular installation. If this equipment does cause harmful interference to radio or television reception, which can be determined by turning the equipment off and on, the user is encouraged to try to correct the interference by one or more of the following measures:

- Reorient or relocate the receiving antenna.
- Increase the separation between the equipment and the receiver.
- Connect the equipment to an outlet on a circuit different from that to which the receiver is connected.
- Consult the dealer or an experienced radio/TV technician for help.

This Class B digital apparatus meets all requirements of the Canadian Interference-Causing Equipment Regulations.

## Advantages of the Advanced Photo System

### Easier to load...

Advanced Photo System cameras use the new IX240 type film. This new film features drop-in-loading to make loading your camera simple, the first time, every time. Indicators on the cassette tell you and your camera if the film is unexposed, partially exposed, exposed, or processed.

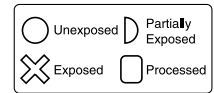

### New features...



**Mid Roll Change** - Rewind your film in the middle of the roll and reload it later, without fear of double exposures. p 34



**Print Quantity Select** - Choose the number of prints you want before taking the picture. p 65



**Date and Title Imprinting** - Set date, time, and title information for your photolab to imprint on your photographs. pp 67-74



**Print Quality Improvement** - Your camera records lighting and exposure information on the film's magnetic strip to help the lab give you the best quality prints.

C



H



P



### New print formats...

Classic C, wider H, and panorama P print formats are available with Advanced Photo System cameras.

### New processing...

In addition to returning your prints in the format you selected, certified photofinishers will return your Advanced Photo System film in its original cassette with an index print. To order reprints, simply choose the images you want from the index print. No more searching through negatives to find the right frame.

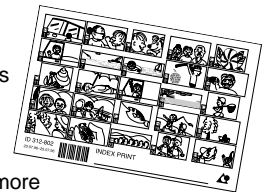

# TABLE OF CONTENTS

FOR PROPER AND SAFE USE .....	4
NAMES OF PARTS .....	11
QUICK OPERATION .....	16
<b>BASIC OPERATION</b>	
Attaching the Camera Strap .....	19
Installing the Batteries .....	20
Attaching and Removing the Lens .....	22
Diopter Adjustment .....	24
Handling the Camera .....	25
Loading Film .....	26
Full Auto Operation .....	30
Rewinding the Film .....	32
<b>FOCUS</b>	
Focus Signals .....	36
Special Focusing Situations .....	37
Focus Hold .....	38
Direct Manual Focus .....	39
Manual Focus .....	40
<b>USING THE BUILT-IN FLASH</b>	
Flash Signals .....	42
Flash Range .....	43
Manual Fill-flash .....	44
Flash Cancel .....	44
Red-eye Reduction .....	45
<b>SUBJECT PROGRAM MODES</b>	
Subject Program Selection .....	47
Portrait Mode .....	48
Landscape Mode .....	49
Close-up Mode .....	50
Sports Mode .....	51
Night Portrait Mode .....	52
Photographing Night Scenes .....	53

## CREATIVE EXPOSURE MODES

Creative Exposure Modes .....	55
A Mode - Aperture Priority .....	56
S Mode - Shutter Priority .....	59
M Mode - Manual Operation .....	62

## ADDITIONAL FEATURES

Print Quantity Select .....	65
Date/Time Imprinting .....	67
Title Imprinting .....	71
Shutter Control	
Self-timer .....	75
Continuous-drive Mode .....	76
Remote Control (optional) .....	77
Bulb .....	80
Exposure Control	
Spot Metering .....	82
Exposure Compensation .....	84
FTPM Fixed Time Printing Mode .....	86
Setting the Film Speed Manually .....	88
Flash Control	
AF Illuminator .....	89
Wireless/Remote Off Camera Flash Control ..	90
Slow-Shutter Sync .....	95

## APPENDIX

Program Reset Button .....	96
Lab Services .....	97
Accessory Information .....	98
Care and Storage .....	101
Technical Details .....	103
Trouble Shooting .....	105
Camera Warnings .....	106
Quick Reference Guide .....	108

# FOR PROPER AND SAFE USE

## STANDARD SYMBOLS

Various symbols are used throughout this instruction manual and on the product itself for the proper and safe use of this product and to prevent personal injury, injury to others, and property damage. An explanation of the symbols follows. Read and understand each caution thoroughly before reading the main text of this instruction manual.

## EXAMPLES



The outer triangle is for warning. The symbol inside illustrates what is being warned against. The example at left means beware of electric shock.



The circle with a diagonal slash is for prohibition (don't do). The symbol inside illustrates what act is prohibited. The example at left means do not disassemble.

## SAFETY CAUTIONS

Read and understand all cautions and warnings thoroughly before using this product.



## WARNING



Do not touch the flashtube during operation, it may become hot when the flash fires.



Do not look directly at the sun through the viewfinder.



Do not subject the camera to direct sunlight. Fire may occur if the sunlight focuses at one point.

### CAUTION



Don't walk while looking through the lens or viewfinder. You may trip and fall causing injury.



Do not fire the flash near the eyes of people or animals, especially infants and young children. Do not fire the flash if your subject is closer than the minimum flash distance stated in the manual.



If the camera is dropped or subjected to an impact in which the interior is exposed, immediately remove the batteries and discontinue use.

Do not disassemble. Take your camera to a Minolta Service Facility when repairs are required. Electric shock may occur if a high voltage circuit inside the camera is touched.



### BATTERY CAUTIONS



Batteries may explode due to improper use. Read and follow all warnings supplied with the batteries.



- Do not install the batteries with the polarity (+/-) reversed.
- Do not use batteries with visible damage.
- Do not subject batteries to fire or high temperatures.
- Do not attempt to recharge, short, or disassemble.
- Do not mix batteries of different types, brands, or ages.

## FOR PROPER AND SAFE USE

Carefully observe the following warnings when using this product near young children, or persons who may have difficulty perceiving the potential danger associated with these products.



### WARNING

Use Caution

If caution is not used, the following accidents or others may occur:

- Flash fired near the eye.
- Strap wound around the neck.



### CAUTION

YOUNG CHILDREN MAY SWALLOW SMALL OBJECTS

Keep small accessories, or things that can be swallowed, away from young children.

Contact a doctor immediately if an object is swallowed.



### BATTERY CAUTION

YOUNG CHILDREN MAY SWALLOW BATTERIES

Keep batteries away from young children.



## SPLASHPROOF

This camera is splashproof and can be used in light rain or snow.

- Do not place the camera under running water or immerse.

Please Note:

1. When using the camera outdoors in heavy rain, keep the camera protected from the rain. Do not leave the camera in the rain.
2. The interior of the camera is not moisture resistant.
  - Dry the camera before opening the film or battery chambers, changing lenses, or installing an accessory flash.
  - Keep your hands dry when inserting or removing film or batteries, changing lenses, or installing an accessory flash.
3. Do not load film or replace batteries in places where water, blowing sand, or dust can enter the camera.
4. This camera is not sandproof. Do not place the camera directly on the ground.
5. Remove moisture from the camera.
6. Do not expose the camera to salt water or liquids containing sugar.
7. If the rubber seals appear cracked or damaged, contact the nearest Minolta Service Facility to have them replaced.
8. Close the film and battery-chamber covers tightly. Clean the rubber seals before closing covers.

### OPERATING TEMPERATURE AND CONDITIONS

- This camera is designed for use from  $-10^{\circ}$  to  $50^{\circ}$  C ( $14^{\circ}$  to  $122^{\circ}$  F).
- Never leave your camera where it may be subjected to extreme temperatures such as the glove compartment of a car.
- At colder temperatures, the data panel response time will be slow; at higher temperatures, the display will temporarily darken, but will restore when the temperature normalizes.
- Never subject the camera to extreme humidity.
- To prevent condensation from forming, place the camera in a sealed plastic bag when bringing it from the cold exterior into a warm building. Allow it to come to room temperature before removing it from the bag.
- The low-battery symbol may appear even with a fresh battery depending on the storage conditions. To restore camera power, repeat turning the camera on and off.
- When photographing in cold weather, we recommend that you keep the camera and spare batteries inside your coat to keep them warm when you are not shooting. Cold batteries will regain some of their charge when they warm up.

### FILM CASSETTE WARNING

The film used in Advanced Photo System cameras stores some data magnetically. Do not place the cassette on or near anything that creates a magnetic field, such as a television or stereo speakers.

## NAMES OF PARTS

For information on specific parts, refer to the page numbers shown in parenthesis.

### Body

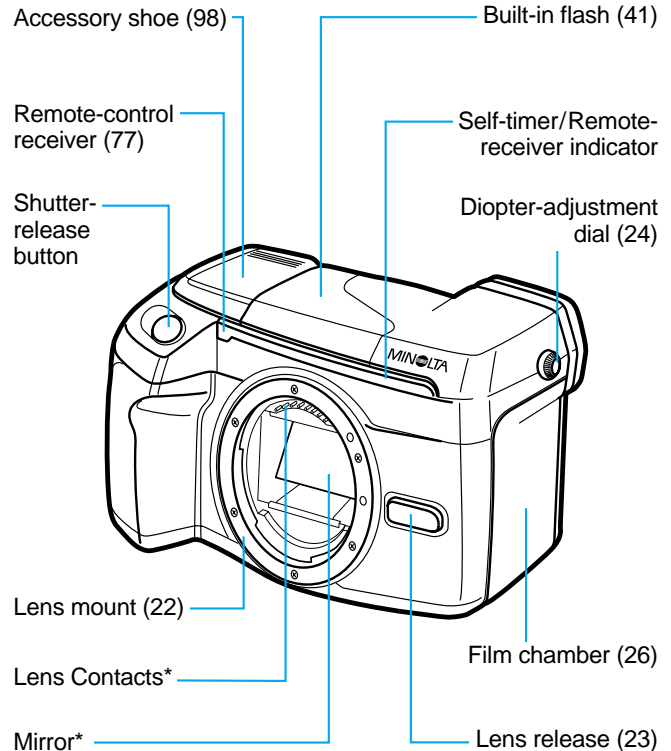

\* Do not touch

## NAMES OF PARTS

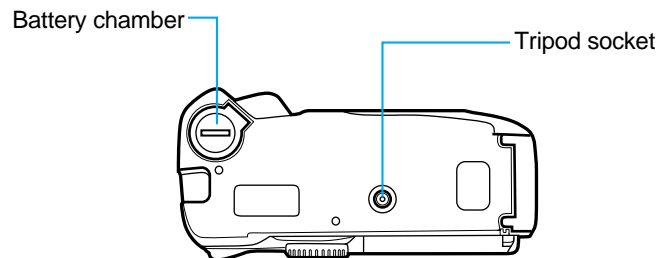
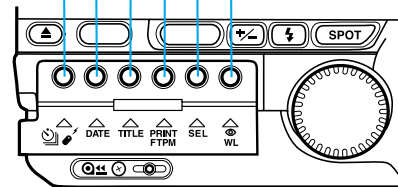
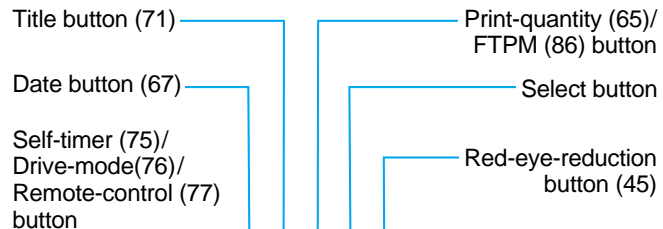
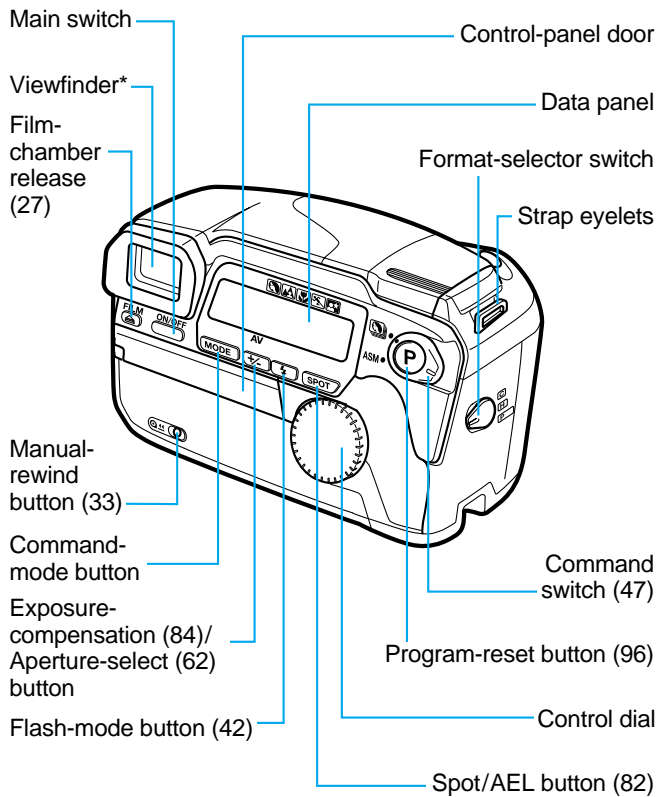



## NAMES OF PARTS

### Data Panel

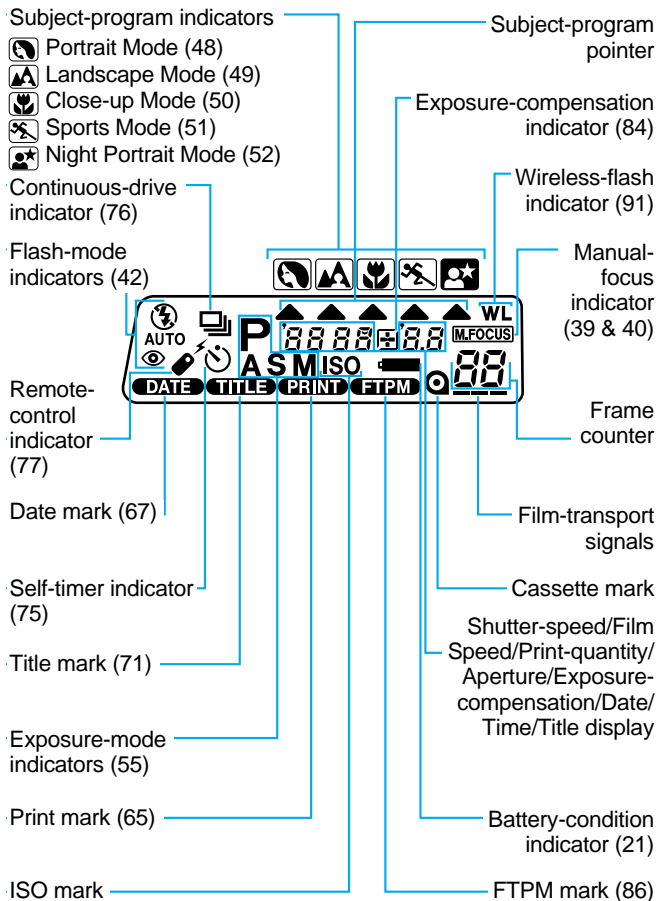

### Viewfinder

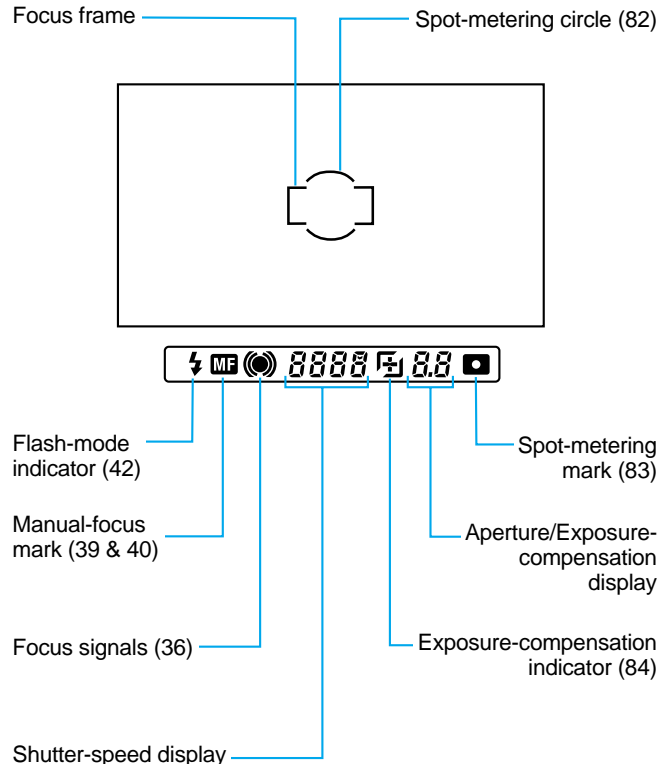

# QUICK OPERATION

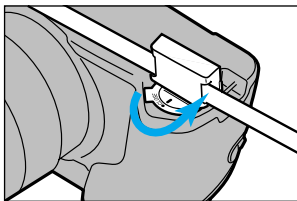

## 1. Insert battery

Using the eyepiece cap, open the battery-chamber cover. Insert the batteries into the chamber, then close and lock the battery-chamber cover.

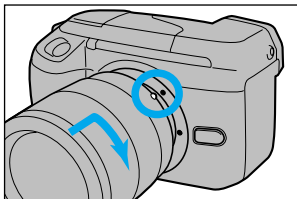

## 2. Attach lens

Align the red mounting dot on the lens with the one on the camera. Gently insert the lens into the mount and turn it clockwise until it clicks into the locked position.

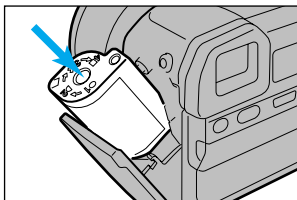

## 3. Insert film

Press the film-chamber release. Insert the film cassette. Close the film-chamber door.

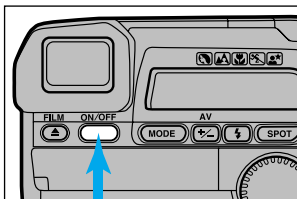

## 4. Turn on power

Press the main switch to turn the camera on.

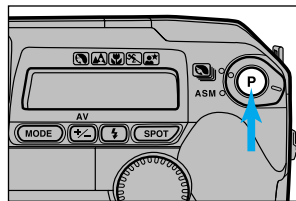

## 5. Set Full Auto operation

Press the program-reset button to set the camera to fully-automatic operation.

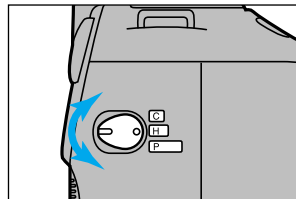

## 6. Select print format

Turn the format-selector switch to the desired format before taking the picture.



## 7. Focus on the subject

Align the subject within the focus frame [ ], then press the shutter-release button partway down. ● or (●) will appear in the viewfinder when the subject is in focus. The flash will pop-up and fire when necessary.

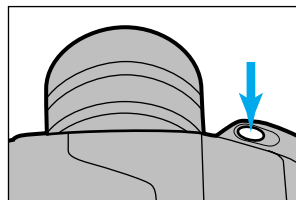

## 8. Take the picture

Press the shutter-release button all-the-way down to take the picture.

# BASIC OPERATION

## ATTACHING THE CAMERA STRAP

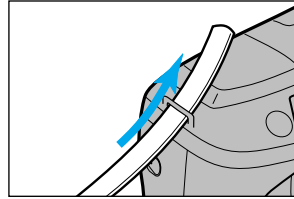

1. Undo the camera-strap buckle and loop the strap through the upper eyelet of the camera.

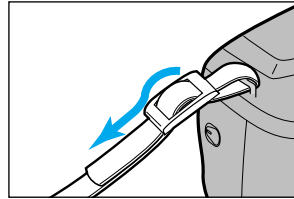

2. Redo the camera-strap buckle.
3. Repeat for the lower eyelet.

# INSTALLING THE BATTERIES

Your camera uses two CR2 batteries to supply power for all camera operations. Please read all warnings in the Safety Cautions section of this manual as well as those supplied by the battery manufacturer.

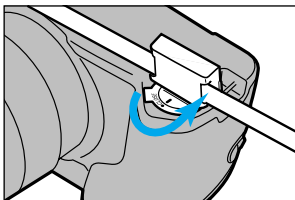

**1. Using the eyepiece cap, turn the battery-chamber cover counter-clockwise and open the battery-chamber cover.**

- Turn the camera off before removing the old batteries.
- Remove dirt and moisture from the camera and batteries before opening the battery-chamber cover.

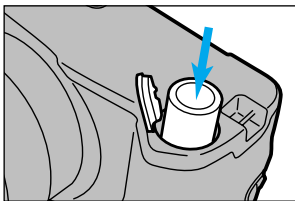



**2. Insert the batteries as indicated by the + and - marks.**

**3. Close the cover then, using the eyepiece cap, turn the battery-chamber cover to CLOSE to lock it.**

- Main power is automatically switched on when a battery is installed.
- If **DATE** and - - - - - blink in the data panel when the camera is turned on, reset the date and time. See page 67.

## Checking the Battery Power

Your camera is equipped with an automatic battery-power indicator. Each time the main switch is turned on, the battery symbol will appear in the data panel to indicate the power status of the batteries. It is recommended that you always carry spare batteries in your camera bag.

 <p>Full-battery symbol</p>	Power is sufficient for all camera operations.
 <p>Blinking low-battery symbol</p>	Power is extremely low, but all functions are operational. Battery will have to be replaced very soon. Flash recycling time may be slow.
 <p>Blinking low-battery symbol alone and the shutter locks</p>	Power is insufficient for camera operation.

If no display appears, replace the battery or check that it is inserted correctly.

# ATTACHING AND REMOVING THE LENS

## Attaching the Lens

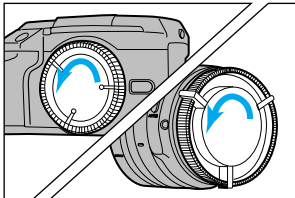

1. Remove the camera body cap and rear lens cap as shown.

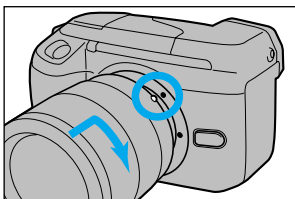

2. Align the red mounting dot on the lens with the red dot on the camera.
3. Gently insert the lens into the mount and turn it clockwise until it clicks into the locked position.

- Do not insert the lens at an angle.
- Do not press the lens release when attaching the lens.

## Removing the Lens

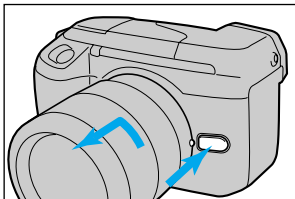

1. Press the lens release and turn the lens counter-clockwise until it stops.
2. Gently remove the lens from the mount and replace the caps, or attach another lens.

### Caution

- Do not force the lens if it does not turn smoothly.
- Do not touch the inside of the camera, especially the lens contacts and mirror.
- Remove dust, dirt, and moisture from the lens mount before attaching or removing a lens.

## Lens Hood

Use the lens hood to reduce flare and ensure maximum image quality.

- Remove the lens hood from your lens before using the camera's built-in flash.

**To attach a bayonet mount lens hood, fit the hood into the bayonet mount on the end of the lens barrel, then turn the lens clockwise until it stops.**

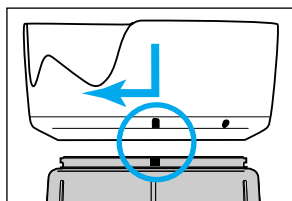

If your lens and hood have guide marks, align the red line on the lens hood with the red line on the lens, then turn the lens hood clockwise until the dot on the lens hood is lined up with the line on the lens.

- To store the lens hood, reverse it and attach it to the lens, then replace the lens cap.

## DIOPTRER ADJUSTMENT

If you are near or far sighted, use this control to adjust the eyepiece for your eyesight. The diopter adjustment range is from -4.0 to +2.0 diopters.

### Adjusting the Diopter

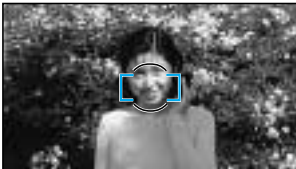

● 250 5.6

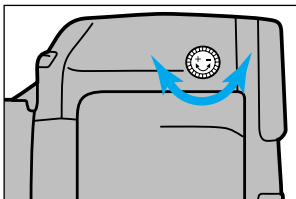

1. Center your subject in the focus frame.
2. Press the shutter-release button partway down to focus on the subject.
3. Turn the diopter-adjustment dial until your subject appears sharpest.

## HANDLING THE CAMERA

### Holding the Camera

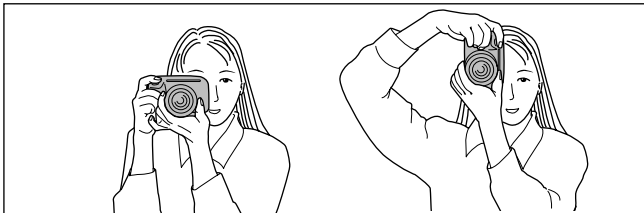

Hold the camera grip firmly with your right hand, while supporting the lens with your left hand. Make sure your fingers are not blocking any of the camera's features. Your fingers should fit securely around the grip. To hold the camera steady, keep your elbows at your side and your feet shoulder-width apart. Always keep the camera strap around your neck or wrist in the event you accidentally drop it.

### Pressing the Shutter Release Button

Press the shutter-release button partway down to activate the camera's autofocus and auto-exposure systems. Gently, never with a quick jab, press the shutter-release button all-the-way down to take the picture.

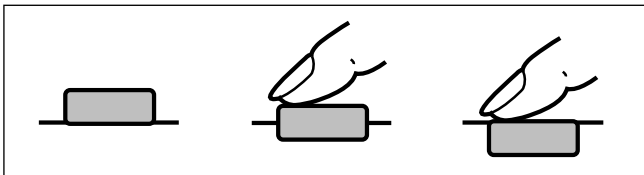

# LOADING FILM

Your camera uses IX240 type film designed for use in Advanced Photo System cameras.

- Your camera has an automatic transport system which loads the film, sets the film speed, and advances the film after each exposure.
- Once loaded, the Film Chamber Lock feature prevents the film chamber from being opened until the film is rewound into the cassette.
- There is no need to worry about double exposure. The DEP (Double Exposure Prevention) feature prevents the camera from accepting exposed film.

## Visual Exposure Indicators

- The current VEI has a white indicator behind it.
- This camera can load film with either the ● or ▸ VEI current.

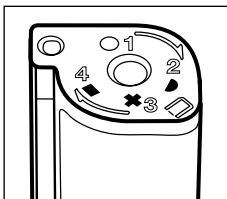

VEI	MEANING
●	UNEXPOSED
▸	PARTIALLY EXPOSED
×	EXPOSED
■	PROCESSED

- Only partially-exposed film (VEI ▸) rewound in Minolta cameras with Mid Roll Change capability can be loaded in this camera.

## Loading the Film

Use IX240 type film designed for use in Advanced Photo System cameras. Your camera will automatically set the proper film speed for the film you are using.

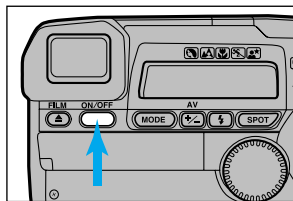

1. Press the main switch to turn the camera on.

- Film can be loaded when the camera is on or off.

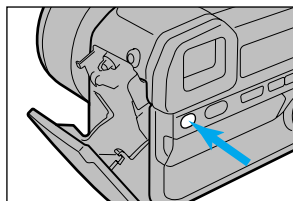

2. Press the film-chamber release on the back of the camera. The film-chamber door will open.

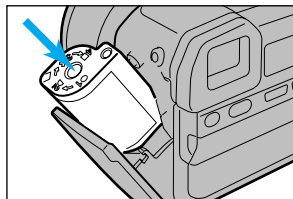

3. Insert the new film cassette into the film chamber with the VEI on top.

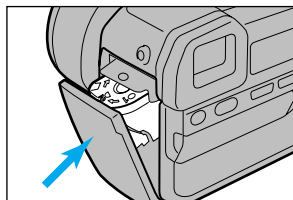

4. Close the film-chamber door.

## LOADING FILM



The film speed appears in the data panel, then the film is advanced to the first frame.



When the loading sequence is complete, the frame counter will show the number of frames remaining on the roll.

- If the shutter-release button is not pressed after loading, an unexposed (●) or partially exposed (◐) roll can be removed by pressing the rewind button, then the film-chamber release. The VEI will be unchanged.
- If film is loaded with the power off, all indicators in the data panel will disappear after the number of frames remaining is displayed.
- After the film is loaded, pressing the film-chamber release will display the film speed and the exposure number in the data panel.

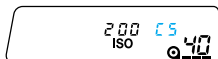



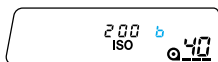



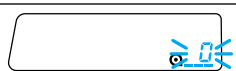

- If slide film is loaded, CS will appear in the data panel when the film-chamber door is closed.



- If black and white film is loaded, b will appear in the data panel when the film-chamber door is closed.



If 0 blinks and  appears in the data panel, press the film-chamber release and remove the film.

- Your camera can not load a film cassette, if the current VEI is  or . Load film with the  or  VEI current.
- If a processed roll of film was loaded into this camera, the VEI has been changed from  to .
- If the film's current VEI is  or , remove the film. Remove and reinsert the batteries, then reload the film. If the problem persists, contact the nearest authorized Minolta Service Facility.

If film is loaded with the  VEI current, take note of the following:

- An accessory flash should not be mounted when loading film with the  VEI current. Do not attach the flash until the camera has advanced to the first unexposed frame.
- Do not load partially exposed rolls within 1m (3.3 ft.) of operating speakers, microwave ovens, hairdryers, etc.



# FULL-AUTO OPERATION

Full Auto is the camera's standard operating mode and is suited for use in almost any situation. When the program-reset button is pressed, the camera is returned to fully-automatic operation. See page 96.

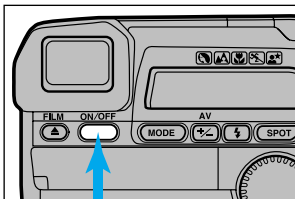

1. Press the main switch to turn the camera on.

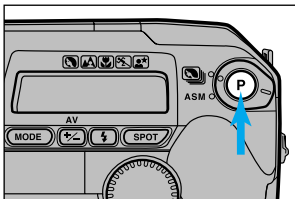

2. Press the program-reset button to set the camera to Full Auto.

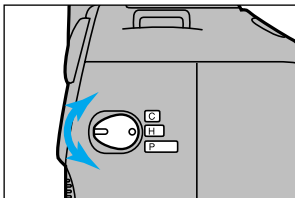

3. Set the format-selector switch to the desired print format (C, H, or P).



4. Center your subject in the focus frame [ ] and press the shutter-release button partway down to activate autofocus. • or (●) will glow when the subject is in focus.

- The built-in flash will pop-up and fire when necessary.

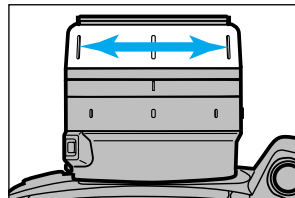

5. If you are using a zoom lens, rotate the zooming ring on the lens to frame the subject as desired.

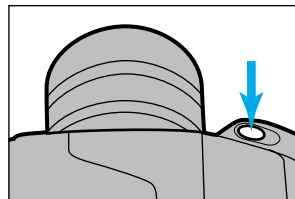

6. Press the shutter-release button all-the-way down to take the picture.

- In low-light conditions, the AF illuminator (flash) will fire to determine focus distance.

- To take a picture with your subject outside the focus frame [ ] use focus hold. See page 38.

# REWINDING THE FILM

## Automatic Rewind

The camera automatically rewinds the film into the cassette after the last exposure.

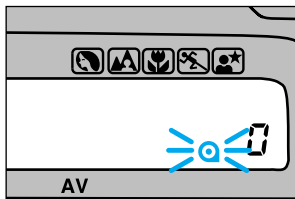

### 1. Wait for the film to completely rewind into the cassette.

- While rewinding, the frame counter will count down.
- 0 will appear in the frame counter and  will blink when the film is rewound.

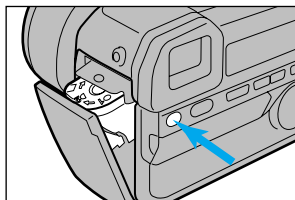

### 2. Press the film-chamber release to open the film-chamber door.

- ### 3. Remove the film.
- The VEI display will be **X**.

## Manual Rewind

Use manual rewind when you want to switch to a different type or speed of film before the current roll is finished.

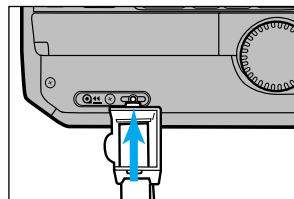

### 1. Using the eyepiece cap press the manual-rewind button.

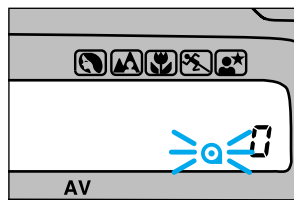

### 2. Follow steps 1-3 from Automatic Rewind.

- See Mid Roll Change for VEI display information.

### Mid Roll Change

---

Your camera can reload partially exposed film originally loaded in a Minolta IX240 type cameras with the MRC feature. Minolta Advanced Photo System cameras with the MRC feature set the VEI for partially exposed rolls to **▶**. Minolta Advanced Photo System cameras without the MRC feature set the VEI for partially exposed rolls to **✕**, and the blank frames can not be exposed.

- Once the **✕** symbol is displayed on the VEI, blank frames can not be exposed.

### Processing

---



For best results, take your film to a certified Advanced Photo System photofinisher displaying this symbol. See page 97.

# FOCUS

## FOCUS SIGNALS

When the camera is set to autofocus (AF) mode, pressing the shutter-release button partway down will activate the autofocus system and one of the signals below will appear at the base of the viewfinder. In autofocus mode, the shutter will not release until the focus is confirmed.

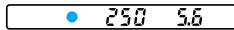
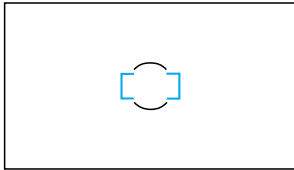

- Focus is confirmed.
- (●) Continuous autofocus, focus is confirmed.
- (○) Continuous autofocus, lens focusing (shutter locked).
- ☀ Focus is not possible (shutter locked). Your subject is too close or is one of the special focusing situations described on the next page.

## SPECIAL FOCUSING SITUATIONS

In the situations like those described below, it may be difficult or impossible for the camera to focus accurately; you may need to use focus hold, direct-manual focus, or manual focus.

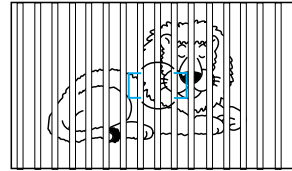

If two subjects at different distances overlap in the focus frame [ ].

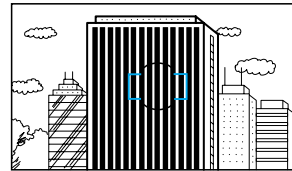

If a subject composed of alternating light and dark lines completely fills the focus frame [ ].

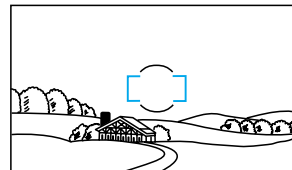

If the subject within the focus frame [ ] is very bright, or low in contrast.

## FOCUS HOLD



Use focus hold when you want to take a picture with your subject outside the focus frame [ ], or when autofocus is difficult to confirm.

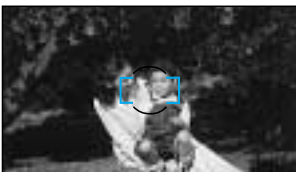

1. Center your subject in the focus frame [ ] and press the shutter-release button partway down.

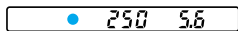

2. Continue to hold the shutter-release button partway down while you compose your picture.
3. Press the shutter-release button all-the-way down to take the picture.

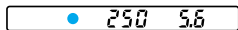

• Focus hold can only be used when ● appears in the viewfinder.

## DIRECT MANUAL FOCUS

Use DMF to adjust the focus manually without taking the camera out of autofocus mode.

1. Press the shutter-release button partway down to activate autofocus (camera must be in AF mode).

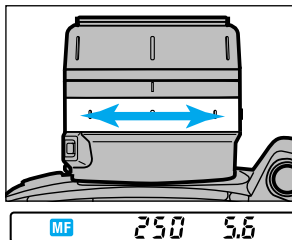

2. Without releasing the shutter-release button adjust the focus manually using the focusing ring on the lens.

• MF will appear in the viewfinder.

3. Press the shutter-release button all-the-way down to take the picture.

- The focus-confirmed indicator (●) will appear in the viewfinder to indicate when the subject in the focus frame is in focus.
- The camera returns to the autofocus mode after the picture is taken, or when you remove your finger from the shutter-release button.
- DMF is not available on lenses without a focusing ring.
- DMF is not possible if (⊙) or (⊕) appear in the viewfinder.

# MANUAL FOCUS

When autofocus is not suitable and focus hold is not possible, focus the lens manually. The autofocus system will monitor focus and indicate when the subject in the focus frame [ ] is in focus.

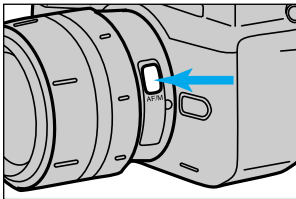

1. Press the focus-mode button, **M.FOCUS** will appear in the data panel and **MF** will appear in the viewfinder.

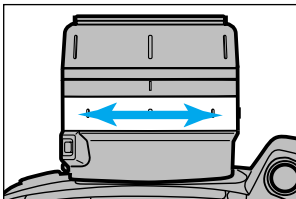
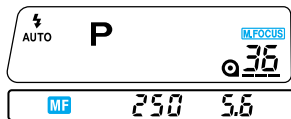

2. Turn the focusing ring until your subject appears sharp and focused.
  - The focus confirmation signal (●) will appear in the viewfinder when the subject in the focus frame is in focus.

- Manual focus is not available on lenses without a focusing ring.
- Press the focus-mode button again to return to autofocus mode.



# USING THE BUILT-IN FLASH

## FLASH SIGNALS

In P mode, the built-in flash will pop-up automatically when the shutter-release button is pressed partway down. Once up, the flash will fire when necessary.

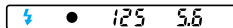
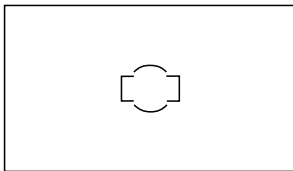
- The shutter will not release until the flash is charged.
- The built-in flash can provide coverage for Advanced Photo System focal lengths as short as 22mm.
- Press the flash down, and select flash cancel when you don't want the flash to fire.



-  glowing Flash is charged and will fire when the shutter-release button is pressed.
-  blinking Flash output was sufficient to provide correct exposure.
- If no flash signal appears in the viewfinder after the flash fires, make sure your subject was within the range of the flash.

## FLASH RANGE

The range of the built-in flash depends on the speed of the film and the maximum aperture of the lens being used. Make sure your subject is within the working range of the flash specified in the table below.

With ISO 200 film

Maximum Aperture	Min Flash Distance	Max. Flash Distance
3.5	0.6m (2 ft.)	4m (13 ft.)
4.0	0.6m (2 ft.)	3.5m (11.5 ft.)
4.8	0.6m (2 ft.)	2.9m (9.5 ft.)
5.6	0.6m (2 ft.)	2.5m (8.2 ft.)

- When using the 22-80mm f/4-5.6 or the 28-56mm f/4-5.6, the flash range will vary slightly with focal length.
  - At wide angle, the range will be from 0.6 to 3.5 m (2 to 11.5 ft.).
  - At 40mm (standard), the range will be from 0.6 to 2.9 m (2 to 10 ft.).
  - In telephoto, the range will be from 0.6 to 2.5 m (2 to 8.2 ft.).
- Use higher speed film or an accessory flash to obtain a greater flash range.
- Lens shadowing may occur when using the built-in flash.
  - Do not use the built-in flash if the subject distance is less than 0.6m (2ft.).
  - Do not use a lens hood with the built-in flash.
- When using the 25-150mm f/4.5-6.3, if you take a close-up picture with its widest focal length, lens shadowing may occur. Make sure your subject is at least 1.3m from the camera, or use optional Vectis flash or Program/Maxxum flash.

## MANUAL-FILL FLASH/FLASH CANCEL

In the manual fill-flash mode, the flash fires every time a picture is taken. When the flash is canceled, the built-in flash will not fire.

### Manual Fill-Flash

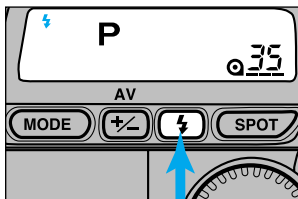

Press the flash mode button until ⚡ appears in the data panel.

- When the program-reset button is pressed, the camera returns to the autoflash mode.

### Flash Cancel

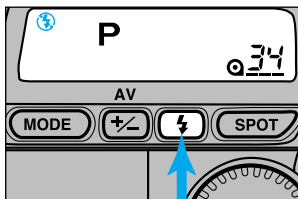

Press the flash mode button until ⚡/ appears in the data panel.

- When the program-reset button is pressed, the camera is returned to autoflash mode.
- If the flash is canceled in low-light situations, the shutter speed may be slow; use a tripod.

## RED-EYE REDUCTION

When photographing people or animals at night or other low-light situations, the effect called red-eye may occur due to the flash reflecting off the inside of the subject's eyes. To reduce this effect and to produce more natural looking photographs, use the built-in flash's red-eye-reduction mode.

### Selecting Red-eye Reduction:

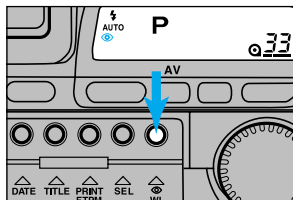

Press the red-eye-reduction/wireless-flash mode button until 👁 appears in the data panel.

- When turned on, the camera is returned to autoflash with red-eye reduction or autoflash without red-eye reduction, whichever was used last.

### Canceling Red-eye Reduction:

Press the red-eye-reduction/wireless-flash-mode button until 👁 no longer appears in the data panel.

### When using Red-eye Reduction:

Warn your subject that the flash will fire a few short bursts just before the picture is taken.



# SUBJECT PROGRAM MODES

## SUBJECT PROGRAM SELECTION

Subject-program selection lets you choose one of the five subject program modes listed below. These program modes customize the exposure settings for the type of picture you will be taking.



Portrait Mode for portrait photography



Landscape Mode for scenic and travel photography



Close-up Mode for close-up photography



Sports Mode for sports and action photography



Night Portrait Mode for night portrait and night scene photography

- Pressing the program-reset button returns the camera to Full Auto. Fully-automatic operation is suitable for most photographic situations. See page 30.

## PORTRAIT MODE



Use Portrait mode when photographing people. Portrait photography benefits from a shallow depth-of-field. A shallow depth-of-field separates the subject from the background. In portrait mode, the camera is set to achieve this effect, leaving you free to compose the picture and capture the perfect expression.

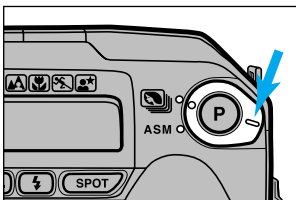

1. Set the command switch to .

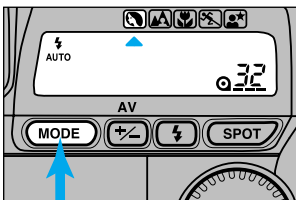

2. Press the command-mode button until the subject-program pointer is under .

### Tips:

- For best results use your lens in the mid-telephoto range (56mm - 80mm).
- Use flash when your subject is backlit, or there are strong shadows across the face.
- Lock focus on your subject's eyes and be ready to capture the perfect expression.

## LANDSCAPE MODE



Select Landscape mode for landscape, scenic, or travel photographs. Landscape photography generally requires a large depth-of-field to make sure everything is in focus. To achieve this, the camera sets the smallest aperture possible while maintaining a fast shutter speed to prevent blur caused by camera shake.

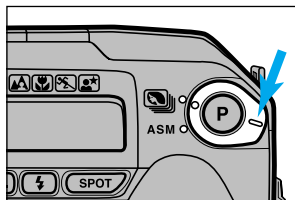

1. Set the command switch to .

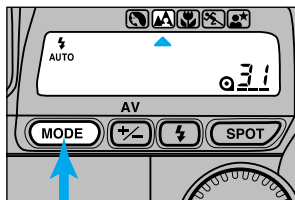

2. Press the command-mode button until the subject-program pointer is under .

### Tips:

- Use a wide angle focal length to create a feeling of depth in the photograph.
- Use flash when a subject in the foreground is backlit or has strong shadows across the face. If there is no subject in the foreground do not use flash.
- Use a tripod, especially at slower shutter speeds.

## CLOSE-UP MODE



Use Close-up mode when photographing objects from short distances. Close-up photography requires accurate focusing; use focus hold, direct-manual focus, or manual focus to ensure sharp focus. The camera will select the best possible aperture and shutter speed for your subject.

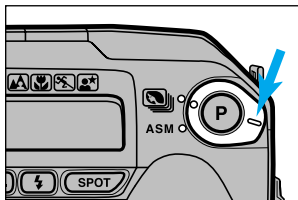

1. Set the command switch to .

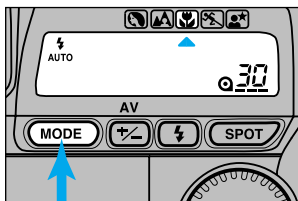

2. Press the command-mode button until the subject-program pointer is under .

### Tips:

- For best results use the V 50mm f/3.5 Macro lens.
- Do not use the built-in flash when your subject is closer than 0.6 m (1.64 ft.), lens shadowing may occur. We recommend using the Macro Flash 1200AF Set or the Vectis Flash SF-1 with the macro panel.
- Use a tripod to reduce camera shake.

## SPORTS MODE



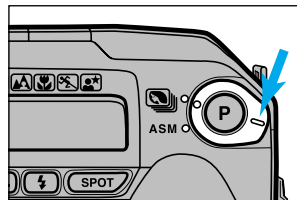

Use Sports mode when a faster shutter speed is needed to stop the action. In Sports mode, the camera sets the fastest possible shutter speed and continually adjusts the focus to track fast-moving subjects.

- The focus will be set to continuous mode (∞). DMF will not be possible.

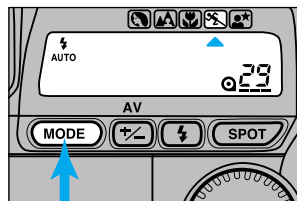

1. Set the command switch to .



2. Press the command-mode button until the subject-program pointer is under .

### Tips:

- Using flash will only help if your subject is within the flash range.
- Use fast film and keep the focus frame on your subject.
- Mount the camera on a tripod when using telephoto lenses.

# NIGHT PORTRAIT MODE



Use Night Portrait mode for taking portraits with scenic backgrounds at night. Night portraits require a balanced exposure between the camera's flash and the background. In this mode, the camera sets the largest possible aperture and a slower shutter speed to allow the background to appear in the photograph.

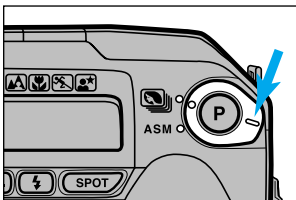

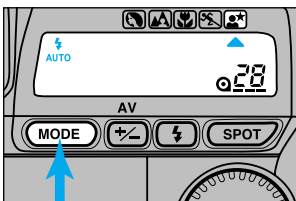

1. Set the command switch to .



2. Press the command-mode button until the subject-program pointer is under .

## Tips:

- Set the flash to  or  when using Night Portrait mode. See page 42.
- Use faster film and a tripod.
- Focus on the main part of your subject.
- Warn your subject not to move while the picture is taken.

# Photographing Night Scenes



Cancel the flash in Night Portrait mode to photograph night scenes. Longer shutter speeds are set in this mode, so you can easily capture beautiful photographs of twilight scenes and night skylines.

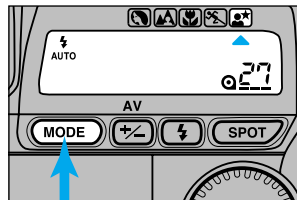

1. Set the camera to Night Portrait mode.

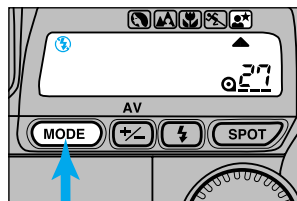

2. Press the flash-mode button until  appears in the data panel.

## Tips:

- Use faster film and a tripod.
- If you are photographing a dark night scene, it may be difficult for the camera to focus, use manual focus or focus hold.



# CREATIVE EXPOSURE MODES

## CREATIVE EXPOSURE MODES

Your camera has four different exposure modes: Aperture-priority, Shutter-priority, Manual, and Program. The exposure modes let you to tailor the degree of camera control needed to capture the desired image. For information on P mode, refer to Full Auto Operation.

A	Aperture Priority Mode	Manually select aperture
S	Shutter Priority Mode	Manually select shutter speed
M	Manual Exposure	Manually select aperture and shutter speed

### Using Flash in A, S, and M Modes

Autoflash does not operate in A, S, or M mode. If the flash is up when A, S, or M mode is set, the flash mode is set to  and will fire every time a picture is taken. If the flash is down when A, S, or M mode is set, the flash is set to  and will not fire. Refer to Using the Built-in Flash on page 42 for additional information.

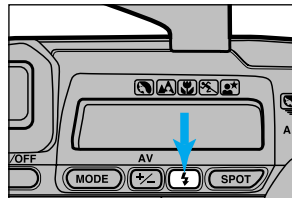

- In A, S, and M modes, press the flash-mode button to raise the built-in flash. Press the built-in flash down to cancel the flash.

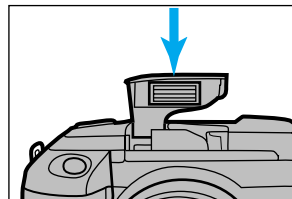

# A MODE - APERTURE PRIORITY

In A mode, you select the aperture and the camera automatically sets the shutter speed required for proper exposure. Set the camera to A mode when you want to control the range of sharpness (depth-of-field) in an image. See Aperture Control on page 58.

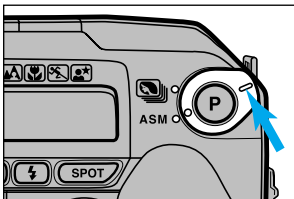

1. Set the command switch to ASM.

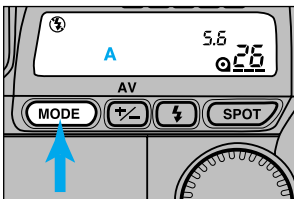

2. Press the command-mode button until A appears in the data panel.

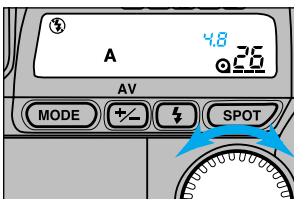

3. Turn the control dial to select the aperture.



- If 2000 or 30" blinks in the data panel, the required setting is beyond the camera's shutter speed range. Turn the control dial until the blinking stops.

- In the viewfinder, only the plane on which the camera is focused will appear sharp. The photographed image will have a depth-of-field corresponding to the aperture used.

## A-Mode Flash

When the built-in flash is up, or an attached accessory flash is on, the flash will fire each time a picture is taken. When the built-in flash is down, or an attached accessory flash is off, the flash will not fire. The camera automatically sets the shutter speed to 1/125 (the flash sync speed). Refer to Flash Range on page 43 or the accessory flash manual to determine the aperture and the flash range.



- If 125 blinks in the data panel, the light level is too bright for the selected aperture. Turn the control dial until the blinking stops.

# APERTURE CONTROL



Large Aperture



Small Aperture

The size of the aperture (lens opening) determines the depth-of-field in the final image as well as the intensity of the light falling on the film. Depth-of-field is the area in front of and behind the point where the lens is focused which will appear sharp.

Large apertures (small numbers) limit the depth-of-field to a narrow range in front of and behind the point of focus. A narrow depth-of-field is used when you want to place greater visual emphasis on your main subject by blurring the background, as in the case of portraits. Small apertures (large numbers) provide greater depth-of-field, bringing an increasingly greater range into focus. A large depth-of-field is important when you are photographing landscapes to ensure the entire scene will be sharp.

- Usable apertures will depend on the aperture range of the lens you are using.

# S MODE - SHUTTER PRIORITY

In S mode, you select the shutter speed and the camera automatically sets the aperture required for proper exposure. This mode is useful when you want to control subject blur.

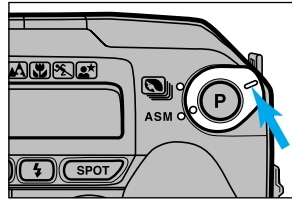

1. Set the command switch to ASM.

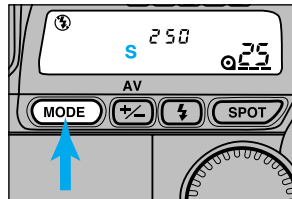

2. Press the command-mode button until S appears in the data panel.

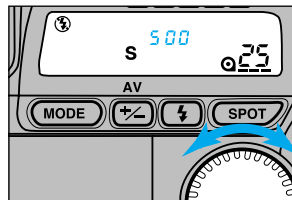

3. Turn the control dial to select the shutter speed.

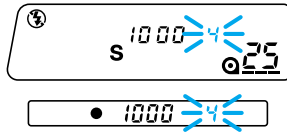

• If the aperture display in the data panel blinks, the required setting is outside the aperture range of the lens. Turn the control dial until the blinking stops.

• The number 60, or 125, displayed in the data panel stands for 1/60th or 1/125th of a second.

### S-Mode Flash

When the built-in flash is up, or an attached accessory flash is on, the flash will fire each time a picture is taken. When the built-in flash is down, or an attached accessory flash is off, the flash will not fire

• Flash operation in the S mode is the same as P mode. The camera automatically sets the aperture and the shutter speed.



Fast Shutter Speed



Slow Shutter Speed

In addition to controlling the duration of the exposure, the shutter speed determines how moving subjects will appear in the final image. Depending on the speed of your subject, slow shutter speeds will make a moving subject appear to flow, creating a feeling of motion. In addition to stopping action, fast shutter speeds can help prevent blur caused by camera shake (camera movement during the exposure).

- To stop the motion of your subject, use a fast shutter speed.
- To blur the motion of your subject, set a slow shutter speed.



# M MODE - MANUAL EXPOSURE

In M mode, you select both the shutter speed and the aperture. The meter index, in the viewfinder display, will tell you if your exposure is over, under, or the same as the metered exposure.

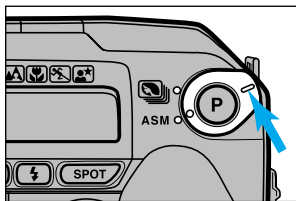

1. Set the command switch to ASM.

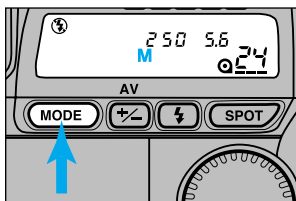

2. Press the command-mode button until M appears in the data panel.

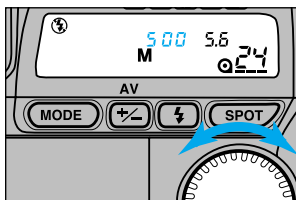

3. Turn the control dial to select the shutter speed.

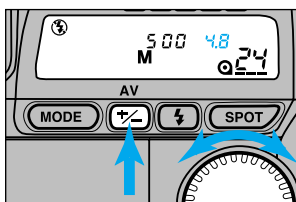

4. While pressing the exposure-compensation/aperture-select button, turn the control dial to select the aperture.

## M-Mode Flash

When the built-in flash is up, or an attached accessory flash is on, the flash will fire each time a picture is taken. When the built-in flash is down or an attached accessory flash is off, the flash will not fire

- Refer to Flash Range on page 43 or the accessory flash manual to determine the aperture setting and the flash range.
- In manual mode, you select both the aperture and the shutter speed for each exposure.
- Do not set the shutter speed faster than 1/125th of a second when using flash.

## Metering in the Manual Mode

In the manual mode, the meter index will display how the exposure you have set compares with the camera's meter reading. The + indicator tells you when your exposure is over, the - indicator tells you when your exposure is under. If neither indicator appears, the camera's meter reading agrees with the exposure you have set.

- Exposure compensation can not be used in the manual mode.
- Change the aperture to obtain half stop corrections.

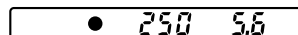

Correct Exposure

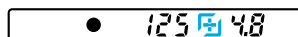

Over Exposure

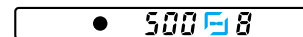

Under Exposure

# ADDITIONAL FEATURES

## PRINT-QUANTITY SELECT

Print-quantity select lets you choose the number of prints you will receive from the lab before taking the picture.

### Setting the Print Quantity

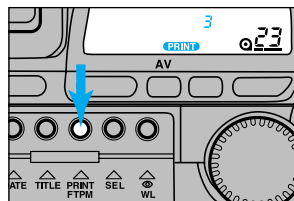

**Before taking the picture-**  
**1. Open the control-panel door and press the print button to enter the desired number of prints.**

- The quantity will be displayed on the data panel.
- Press the print button to increase the quantity by one.
- The quantity can be set to a maximum of nine. After 9, the quantity restarts at 1.
- Press the shutter-release button partway down to return to the normal data panel display; **PRINT** will remain in the data panel.



**2. Take the picture.**

- The quantity is reset to one for the next frame.
- After taking the picture, the print quantity can only be changed to 0.
- The default quantity for color slide film is 0.
- Some labs may not be able to read the print quantity data. See your photofinisher for details.

### Setting the Print Quantity to Zero

If someone walked into the picture at the last moment, or you don't need prints, you can set the print quantity to zero after taking the picture.

- Zero the print quantity before taking the next picture.
- Automatic rewind prevents the last frame from being zeroed.

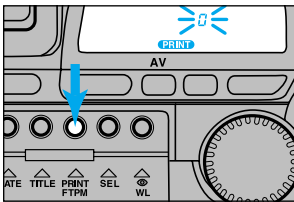

After taking the picture-

1. Open the control-panel door, then press and hold the print button until the quantity displayed changes to a blinking zero.

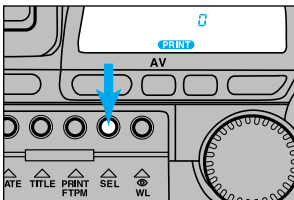

2. Press the select button.

- The camera will wind the film back to rewrite the data, then readvance the film to the next frame.

- Once selected, this quantity is not changeable until reprints are ordered.
- The exposed frame itself remains on the film and can be printed when ordering reprints.
- Some labs may not be able to read the print quantity data. See your photofinisher for details.

Your camera records date, time, and title information on the film's magnetic data strip. The recorded information is read at the photo lab and imprinted on the back of your photographs.

- Some labs can not print date and/or time information on the front of your photographs. See your photofinisher for a full description of available services.
- This camera always records date and time information on the film's magnetic data strip.
- See your photofinisher for details on having date and time information imprinted onto prints made from the slides.

### Setting the Date/Time

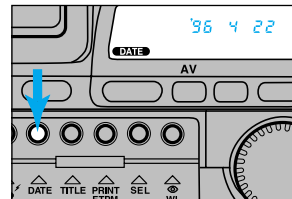

1. Open the control-panel door, then press the date button.

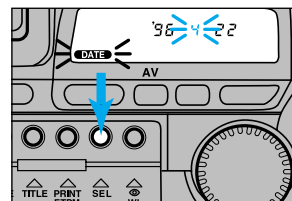

2. Press the select button until the item you want to adjust blinks.
- Each press of the select button causes the next item to blink.
  - The sequence is as follows:  
year -> month -> date -> hour  
-> minute -> stops blinking

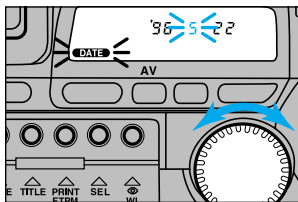

3. Turn the control dial to adjust the blinking item.

4. Repeat steps 2 and 3 until all items in the date and time display are correct.
5. Press the date button, or press the select button until the display stops blinking, to set the updated information.
  - After setting the date/time information, press the shutter-release button partway down to return to the standard data-panel display.
  - This camera has a quartz clock and automatic calendar through the year 2029.
  - Follow the sequence as stated above. If the wrong button is pressed, the new data will not be entered.

## Changing the Date/Time Format

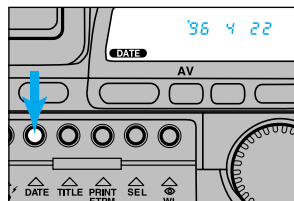

1. Open the control-panel door, then press the date button.

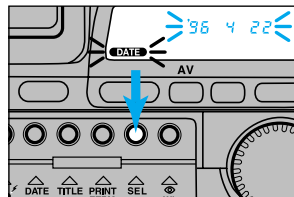

2. Press and hold the select button until all items in the date display blink.

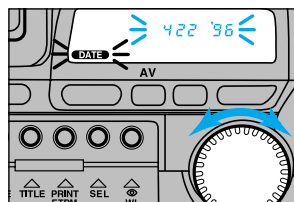

3. Turn the control dial to change the display format.

The sequence is as follows:  
``Y M D -> M D `Y -> D M `Y`

4. Press the date button, or press the select button until the display stops blinking, to set the chosen format.

- After changing the date/time format, press the shutter-release button partway down to return to the standard data-panel display.
- Follow the sequence as stated above. If the wrong button is pressed, the new format will not be entered.

## Imprinting the Date or Time

**Before taking the picture-**

**1. Open the control-panel door.**

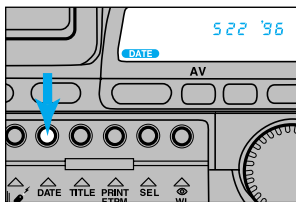

**2. Press the date button until the data panel displays the format you want to see on the print.**

The sequence is as follows:  
Date -> Time -> - - - - - (No Imprinting)



• After selecting the desired date/time format, press the shutter-release button partway down to return to the standard data-panel display; **DATE** will remain in the data panel.

- The same format will be printed on the front and the back of the print.
- If front imprinting is not selected, all the date and time information will be printed on the back of the photograph.

Three titles from the title list can be preset for use while taking pictures. Any one of the preset titles can be selected before the picture is taken. When chosen, the selected title will be recorded on the film's IX data strip. At certified Advanced Photo System photofinishers, the selected title will be printed on the back of the print.

Some labs may not be able to print the titles in all of the available languages. See your photofinisher for details.



Titles are displayed in the data panel as a title code. Please refer to the Title List for the titles available with this camera.

## Preselecting Titles

Three title codes have been set into memory. You can change one or all three title codes at any time.

**1. Select the code for the title you want from the Title List.**

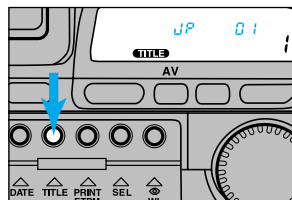

**2. Open the control panel door, then press the title button to display the title code you want to change.**

## TITLE IMPRINTING

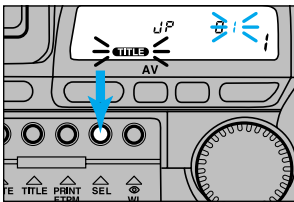

**3. Press the select button, the first digit of the title code will blink.**

- Pressing the select button causes the next item to blink, starting at the right and moving to the left.

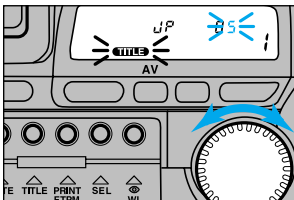

**4. Rotate the control dial to change the value of the blinking number.**

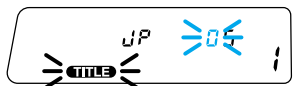

**5. Press the select button to make the next digit blink. Rotate the control dial to change its value.**

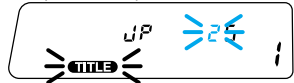

**6. Press the select button to make the language code blink, then rotate the control dial to change the language code.**



**7. When the title information is correct, press the title button, or press the select button until the display stops blinking.**

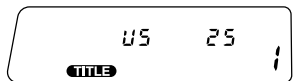

- Press the shutter-release button partway down to return to the standard data-panel display. After setting the title information, **TITLE** will remain in the data panel.
- Follow the sequence as stated above. If the wrong button is pressed, the new data will not be entered.

## Frame Title Imprinting

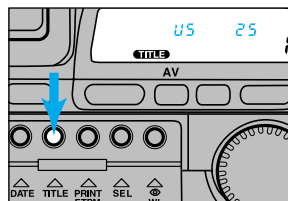

**Before taking the picture-**  
**1. Open the control-panel door.**

**2. Press the title button to select the desired title.**

- Each press of the title button changes the title to the next selection.
- The title number (1, 2, or 3) is displayed in the lower right hand corner of the data panel.



- Press the shutter-release button partway down to return to the standard data-panel display. After setting the title information, **TITLE** will remain in the data panel.

**3. Take the picture. The IX Data is written and the selection is canceled for the next frame.**

## Filmstrip Title Imprinting

You can choose a title for the entire roll of film. Both the filmstrip title and the frame title will be imprinted on the back of the photograph.

- The filmstrip title will be imprinted on the back of every print.

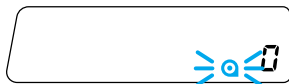

After the film has been rewound and **Q** blinks in the data panel-

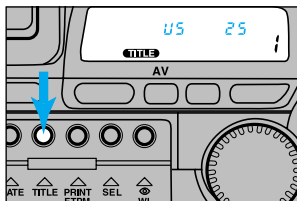

1. Open the control-panel door and press the title button to select the desired title.

- Each press of the title button changes the title to the next selection.





2. Press the shutter-release button all-the-way down to set the title.

3. When **Q** blinks in the data panel again, press the film-chamber release and remove the film.

- Set the filmstrip title before removing the film. Once the film has been removed, a filmstrip title can not be recorded.
- Once set, the filmstrip title can not be changed or canceled using the camera.
- Filmstrip titles set on rolls rewound at mid roll will appear on frames exposed after reloading.
- A filmstrip title can not be set on a reloaded partially exposed roll.

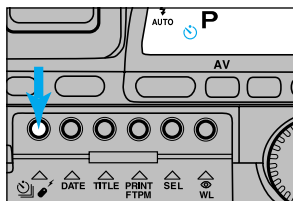
The self-timer will delays the release of the shutter for approximately 10 seconds after the shutter-release button is pressed.



1. Place the camera on a tripod, then press the self-timer button, until  appears in the data panel.
2. Center your subject in the focus frame.

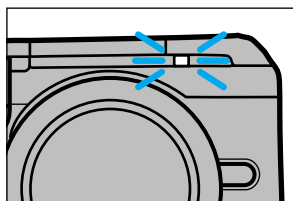



3. Press the shutter-release button all-the-way down to start the timer. The self-timer indicator on the front of the camera will blink, then glow just before the shutter releases.

- The self-timer mode will automatically cancel after the shutter is released.
- Do not press the shutter-release button while standing in front of the camera.
- If you want to take a picture with your subject outside of the focus frame, use focus hold. See page 38.
- To cancel the self-timer before the shutter releases, press the main switch to turn the camera off, or press the self-timer button.

## CONTINUOUS-DRIVE MODE

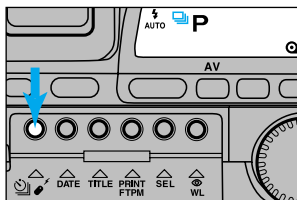
In this mode, the camera will release the shutter and advance film as long as the shutter-release button is held down.



**1. Press the drive-mode button until  appears in the data panel.**

**2. Press the shutter-release button down and hold.**

- The camera will continue to release the shutter and advance the film as long as the shutter-release button is held down.

- When taking flash pictures, the shutter will release after the flash is charged.
- When the subject is moving, the shutter will release after the camera focuses on the subject.
- The frame title and print quantity do not change during a continuous drive series of pictures.
- To cancel continuous-drive mode, press the drive-mode button until the drive-mode indicator disappears from the data panel, or turn the camera off.

## REMOTE-CONTROL (optional)

The IR Remote Control RC-3 is an optional accessory you can purchase to operate your camera from up to 6m (19.7 ft.) away.

- The remote control may not operate with backlit subjects or under fluorescent light.
- To save power, remote-control mode is canceled if the remote control is not operated for more than eight minutes.
- If there is a bright light source behind the camera, attach the eyepiece cap. See page 81.
- The IR Remote Control RC-3 is not splashproof.

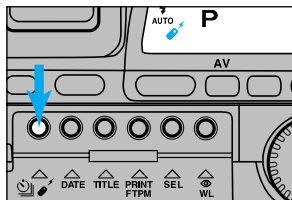

**1. Place the camera on a tripod, then press the remote-control button until  appears in the data panel.**

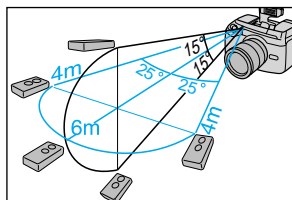

**2. Arrange the camera and subject positions, then compose your picture.**

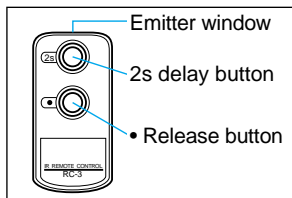

**3. Point the remote emitter toward the front of the camera and press the  or 2s button.**



## REMOTE-CONTROL MODE

- If the **•** button (release button) is pressed, the lamp on the front of the camera will blink once before the picture is taken.
- If the **2s** button is pressed, the lamp on the front of the camera will blink for two seconds before the shutter releases.
- To cancel, press the remote-control button again, or turn the camera off.
- If the camera's remote-control receiver does not blink, the camera did not receive the signal.
- If the flash 'pops up' when the release button on the remote control is pressed, wait a few seconds for the flash to charge, then press the release button again to take the picture.
- If the flash is up and charged when the remote's release button is pressed, the picture will be taken immediately.

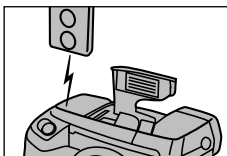

- Use the IR Remote Control RC-3 from 20cm (approx. 8 in.) above the camera to eliminate camera shake.

## Focus Hold in Remote-Control Mode

When your subject is not centered in the focus frame, use manual focus or focus hold.

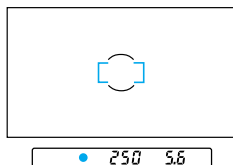

1. Set the camera to the remote-control mode.
2. Center your subject in the focus frame, then press the shutter-release button partway down until **•** appears in the viewfinder.

3. Lift your finger from the shutter-release button.
4. Recompose the picture, if necessary.
5. Point the remote toward the front of the camera and press the **•** or **2s** button.
  - Focus will remain locked until any button on the camera is pressed.

## Changing the Battery

The remote control uses a 3V lithium battery (CR2032). When pressing the remote-control buttons does not release the shutter, the battery must be replaced. A new battery should provide approximately ten years of operation.

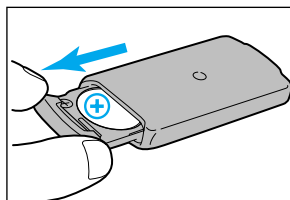

1. Pull out the battery chamber and remove the old battery.

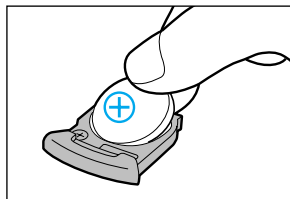

2. Insert a new battery into the battery chamber with its plus side up.
3. Slide the battery chamber back into the remote control.

# BULB



Bulb can only be used in M mode. When set, the shutter will remain open as long as you press the shutter-release button. To avoid blurry pictures, mount the camera on a tripod and use the optional IR Remote Control RC-3 to release the shutter.

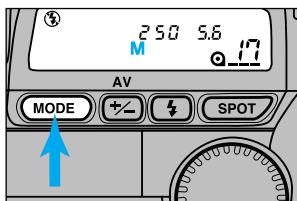

1. Select M mode.

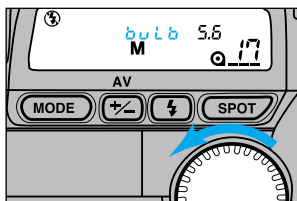

2. Turn the control dial until bulb appears in the data panel.

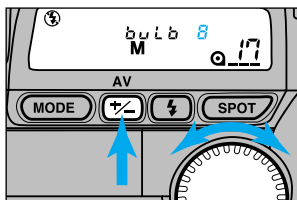

3. Press and hold the exposure-compensation/aperture button, then turn the control dial to set the aperture.

4. Mount the camera on tripod and compose the picture.

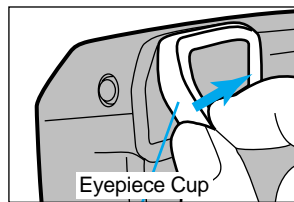

5. Remove the eyepiece cup.

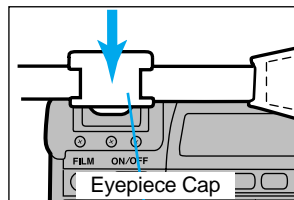

6. Slide the eyepiece cap on.

- The eyepiece cap prevents stray light from entering the eyepiece and affecting exposure.

7. Press and hold the shutter-release button to take the picture.

- The shutter will remain open until the shutter-release button is released.
- The shutter speed data on the back of the print will be recorded as 100 seconds.

## When using the IR Remote Control RC-3

1. Press the **•** button to open the shutter immediately, or press the **2s** button to delay the release for two seconds.
2. Press either button to close the shutter.

# SPOT METERING

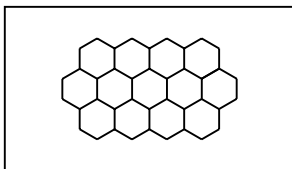

14-segment  
honeycomb pattern

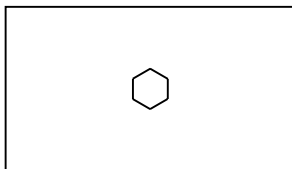

Spot metering

The standard metering mode for this camera uses a fourteen segment honeycomb pattern metering system to determine the correct exposure.

When you want to set the exposure according to a very small part of the scene, spot metering lets you use a single metering segment to determine correct exposure. When selected, only the center segment of the honeycomb pattern is used to read the brightness of the subject in the spot circle in the center of the viewfinder.

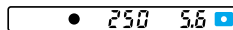
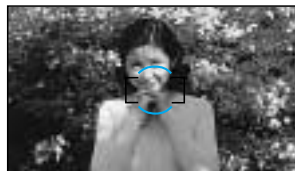
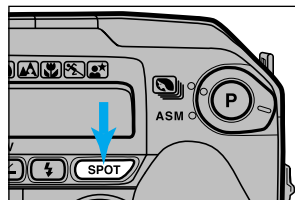
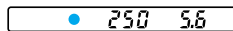
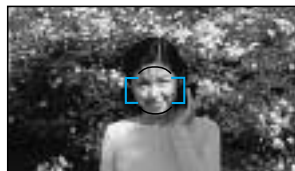

1. Focus on the subject.

2. Press and hold the spot/AEL button.  will appear in the viewfinder

- Exposure will be locked until the spot button is released.

3. Recompose the picture, then press the shutter-release button all-the-way down to take the picture.

- Spot metering is available only when the flash does not fire. If the spot button is pressed when the flash is fired, slow-shutter sync is set. See page 95.

# EXPOSURE COMPENSATION



Over Exposure



Under Exposure



Metered Exposure

This function lets you compensate the exposure  $\pm$  3 EV in 1/2 EV increments when the camera's metering system may not be able to accurately determine exposure. More exposure is recommended for very bright scenes, such as snow or beach scenes. Less exposure is recommended when the scene is composed of darker tones.

- When using exposure compensation with negative film, set Fixed Time Print Mode. See page 86.

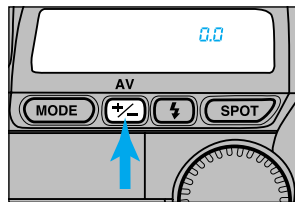

1. Press and hold the exposure-compensation button, then turn the control dial until the desired compensation value appears in the data panel.

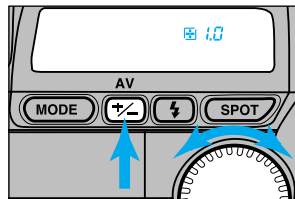

2. Release the exposure-compensation button to enter the number.

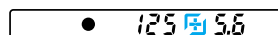
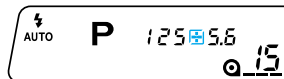

- $\frac{+}{-}$  or  $\frac{+}{-}$  will remain in the data panel and viewfinder as a reminder that exposure compensation is set.

- To cancel exposure compensation, perform the above procedure and select 0.0.
- Exposure compensation is not available in manual mode.

# FTPM - FIXED TIME PRINTING MODE



with FTPM



without FTPM

FTPM ensures that your film will be printed as it was exposed, without compensation by the printer.

- FTPM can only be selected for the whole roll of film, not for a specific image on the roll.
- Some labs may not be able to read the FTPM data. See your photofinisher for details.



After the film has been rewound and  blinks in the data panel-

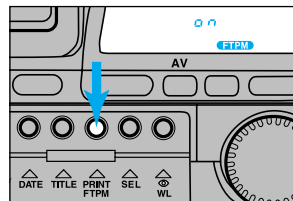

1. Press the **PRINT/FTPM** button. 'on' will appear in the data panel.

• If the FTPM button is pressed again, FTPM will be canceled.

2. Press the **shutter-release** button all-the-way down.



3. When  blinks in the data panel again, press the **film-chamber release** and remove the film.

- FTPM and a filmstrip title can be set at the same time.
- Setting FTPM cancels Mid Roll Change, and sets the film's VEI to **X**.
- FTPM can not be set on reloaded partially exposed rolls (VEI **D**).
- Once set, FTPM can not be canceled.
- FTPM can not be selected for slide film.
- Some labs may still compensate some of the exposures.

## SETTING THE FILM SPEED MANUALLY

The film speed can be set manually when you want to override the DX-coded film speed. Film speeds can be set manually from ISO 6 to ISO 6400 in 1/3 EV increments.

- The film speed will be set for the entire roll, not for a single exposure.

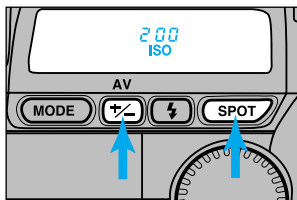

1. Press the exposure-compensation/aperture-select and the spot/AEL buttons at the same time.

- The film speed setting appears in the body data panel.

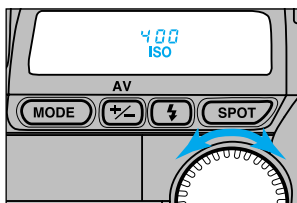

2. Turn the control dial to set the film speed.

3. Press the shutter-release button partway down to return to normal operation.

- If the film speed has been set manually, the film speed will blink when the camera is turned on.
- The original DX-coded film speed will be set when partially exposed film is reloaded.

## AF ILLUMINATOR

If the camera detects that the scene is too dark to focus accurately, the flash will pop-up and fire a few short bursts before and after the lens focuses (AF Illuminator). This provides the light necessary for the camera to detect and focus on your subject.

- The range of the AF Illuminator flash is approximately one to five meters.
- When an accessory flash is attached, the accessory flash's AF Illuminator will be used.
- The AF Illuminator does not fire in Sports Mode.

### Turning the AF Illuminator Off

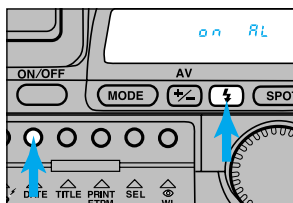

1. Press the flash-mode and the date/time-mode button simultaneously. ON AL appears in the data panel.

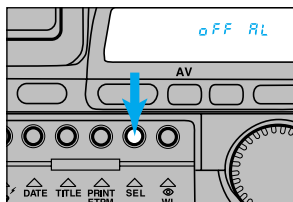

2. Press the Select button. OFF AL appears in the data panel.

- Press the shutter-release button partway down to return to the normal data-panel display.

- Repeat the procedure to turn the AF Illuminator back on.

## WIRELESS/REMOTE OFF-CAMERA FLASH CONTROL



Normal Flash



Wireless/Remote Flash



Wireless/Remote Ratio Flash

Wireless/Remote Off-Camera Flash Control is available with the Minolta accessory flashes: 5400HS, 5400xi, or 3500xi. Wireless/Remote flash lets you experiment with creative lighting techniques using off-camera accessory flashes without the usual tangle of accessory cords and connectors.

In Wireless/Remote flash mode, the off-camera flash is triggered by a coded signal from the camera's built-in flash when you press the shutter-release button. Another signal stops it once the camera's TTL flash meter detects that proper exposure has been received. A 2:1 lighting ratio can also be obtained automatically. When selected, the off-camera flash provides 2/3 of the full exposure and the built-in flash provides the remaining 1/3.

## Setting Wireless/Remote Flash Mode

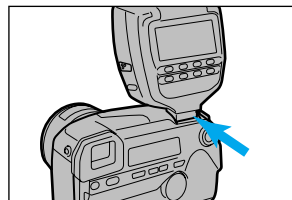

1. Attach the accessory flash (5400HS, 5400xi, or 3500xi) to the camera and turn both the flash and the camera on.

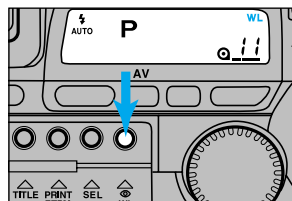

2. Press the red-eye-reduction/wireless-flash button, WL will appear in the data panel.

- The flash is now set for wireless/remote flash operation.

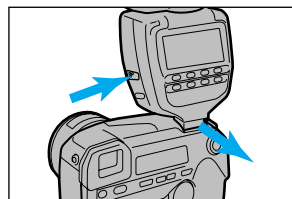

3. Remove the accessory flash.

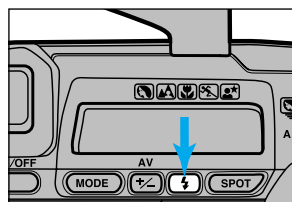

4. Press the camera's flash-mode button to raise the built-in flash. The accessory flash is now ready to be positioned.

## WIRELESS/REMOTE OFF-CAMERA FLASH CONTROL

### Taking Pictures In Wireless/Remote Flash Mode

1. Position your camera and 3500xi flash unit using the information on this page. If you are using a flash unit other than the 3500xi off camera, refer to the instruction manual for that flash to determine the aperture, camera to subject distance, and the flash to subject distance.

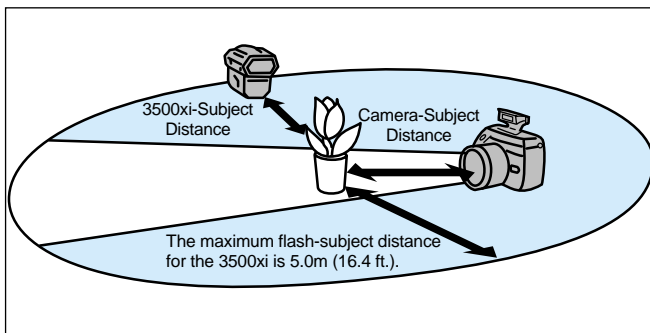

- The off-camera flash may not detect the control signals if it is placed behind the subject.

Aperture	Camera - Subject Distance	3500xi - Subject Distance
f/4	1.4 - 5.0 m 4.6 - 16 ft.	1.0 - 5.0 m 3.3 - 16 ft.
f/4.8	1.2 - 5.0 m 3.9 - 16 ft.	0.85 - 5.0 m 2.8 - 16 ft.
f/5.6	1.0 - 5.0 m 3.3 - 16 ft.	0.7 - 4.5 m 2.3 - 14.5 ft.

- Calculated for ISO 200 film only.

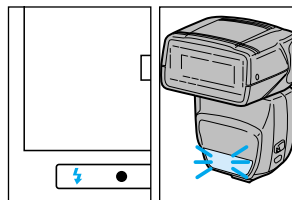

2. When the built-in flash is charged, ⚡ will glow in the viewfinder. When the off-camera flash is charged, its AF illuminator will blink.

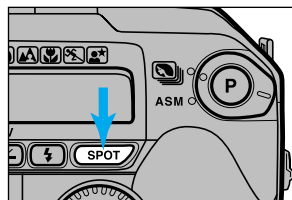

3. Press the spot/AEL button to test fire the accessory flash, and wait again for both flashes to charge.
4. Press the shutter-release button all-the-way down to take the picture.

### Using the Optional Remote Control

To avoid underexposed images when using the remote control with wireless/remote off-camera flash, keep the remote control at least one meter away from, and do not point the remote control at, the off-camera flash.



## Canceling the Wireless/Remote Flash

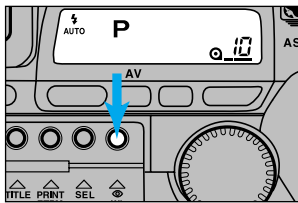

1. Reattach the accessory flash to the camera.
2. Press the red-eye-reduction/wireless-flash button.

- WL will disappear from the data panel.

- To cancel wireless/remote-flash mode on the camera only, press the red-eye-reduction/wireless-flash mode button without attaching the flash.
- To cancel wireless/remote-flash mode on the 3500xi only, turn the flash off, then press and hold the ON/OFF button until the wireless lamp turns off.
- To cancel wireless/remote-flash mode on other flash units, refer to your flash owners manual.

## Wireless/Remote Ratio Control

In wireless/remote mode, when ratio control is selected, the output of the off-camera flash and built-in flash combine to provide a 2:1 lighting ratio.

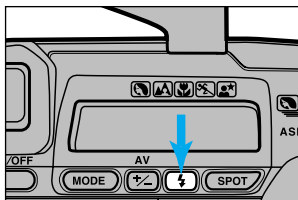

To use ratio control

1. Press and hold the flash-mode button.
2. Press the shutter-release button all-the-way down to take the picture.

## SLOW-SHUTTER SYNC

Slow-shutter sync balances the existing light and flash exposures to let you photograph portraits with scenic backgrounds at night or in other low-light situations.

- Slow-shutter sync is similar to Night Portrait mode. Use slow-shutter sync in A mode, where Night Portrait mode is not available.

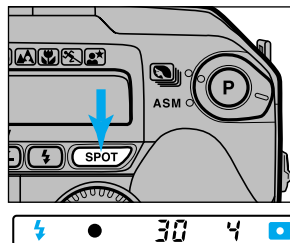

**While pressing the spot/AEL button, press the shutter-release button all-the-way down to take the picture.**

- In A, S, and M modes, press the flash-mode button to raise the flash.
- Use of a tripod is recommended.

# APPENDIX

## PROGRAM-RESET BUTTON

The program-reset button quickly returns the camera to fully-automatic operation. Pressing the program-reset button will set the camera as follows:

FUNCTION	P-MODE SETTING
Exposure mode	P mode
Focus mode	Autofocus
Flash mode	Auto-on
Exposure Compensation	+/- 0
Film-drive mode	Single-frame advance
Self-timer	Canceled
Wireless/Remote Flash	Canceled

- Title, date, print quantity, red-eye reduction, manual film speed, and AF illuminator settings will not change.

## LAB SERVICES



To receive the best possible prints, take your film to a photolab displaying the Certified Advanced Photo System Photofinishing Service logo. Photofinishers displaying this logo have been certified according to Advanced Photo System guidelines.

- The following is a list of services required for certification. See your photolab for a full list of available services.

Photolabs displaying this logo will be able to provide the following five services.

### 1. CHP - Print Format

Your film will be printed according to the format set when the picture was taken.

### 2. Date and Title Imprinting

The date, time, and selected title are printed on the back of the picture in the chosen format.

### 3. PQI - Print Quality Improvement

The lab will compensate (or not compensate) printing according to the data recorded on the magnetic data strips.

### 4. Film is returned in the cassette.

To keep the film dust free and aid in organization, film is returned in its original film cassette. The VEI will be set to ■ to prevent accidental loading.

### 5. Index Print

An index print showing a numbered image of each frame is included with your returned order.

### Reprints

Images are always captured in the H format however, any of the three formats can be selected when ordering reprints.

# ACCESSORY INFORMATION

This camera is designed to work specifically with lenses, flash units, and other accessories manufactured and distributed by Minolta. Using incompatible accessories with this camera may result in unsatisfactory performance or damage to the camera and accessories.

## Lenses

All V-series lenses can be used with this camera.

## Flashes

All Vectis, i, xi, and HS series flash units can be used with this camera.

- X-Series flash units can not be used with this camera.

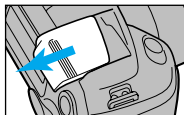

**To attach an accessory flash, remove the accessory shoe cap as shown.**

- Dry the camera and flash contacts before mounting the flash.

- Advanced Photo System lenses require shorter focal lengths to obtain the same angle of view as their 35mm counterparts. Refer to the table below to determine the widest focal length your accessory flash will cover.

Coverage for 35mm Focal Length	Coverage for Advanced Photo System Focal Length
24 mm	19 mm
28 mm	22 mm
35 mm	28 mm

- Only Vectis series flashes are splashproof. Do not allow other series flash units to get wet.

## Accessory Flash Control

When using an accessory flash with your camera, you may select any of the three flash modes. Please read the following instructions for selecting accessory flash modes.

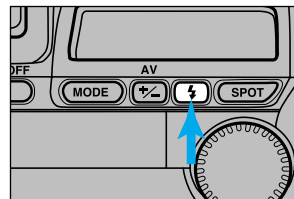

### Changing the flash mode

Press the camera flash-mode button to select the desired mode: **AUTO** (⚡<sub>AUTO</sub>), **ON** (⚡), or **OFF** (⊞).

- All information is transferred directly to the accessory flash.

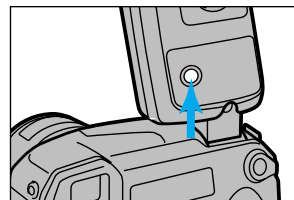

### Using the flash

Press the flash **ON/OFF** button to select the desired mode:

Select ⚡<sub>AUTO</sub>, or ⊞ in **P** and **Subject program modes**.  
Select ⚡, or ⊞ in **A, S, or M modes**.

- Flash data is not transferred to the camera until the shutter-release button is pressed partway down.

### Accessory Flash Notes

---

- To use an AF series flash unit, the Flash Shoe Adapter FS-1100 must be attached to the camera. When the flash is on, the flash will fire each time the shutter is released. At no time will the flash's AF illuminator activate.
- The 5400HS, 5400xi, 3500xi, 5200i, 3200i, and 4000AF flashes zoom according to the focal length of the lens.
- The flash range and coverage angle of the 5400HS, 5400xi, 5200i, and 4000AF flashes is suitable for Advanced Photo System focal lengths. The coverage displays may not display Advanced Photo System focal lengths accurately. For example, the 56mm Advanced Photo System focal length will be displayed as 50mm or 60mm.
- The flash range diagrams in the 3500xi, 2000xi, 3200i, and the 2000i flash units are applicable for Advanced Photo System focal lengths.

### Not for use on Vectis system cameras

---

- Close-up Diffuser CD-1000
- Wireless Remote Flash Controller
- Eyepiece Corrector 1000
- Wireless Controller IR-1N

This manual contains information regarding products introduced before August, 1996. To obtain compatibility information for products released after this date, contact the authorized Minolta Service Facility nearest you.

### Cleaning

- If the camera or lens barrel is dirty, wipe it gently with a soft, clean, dry cloth. If the camera or lens comes in contact with sand, gently blow away loose particles - wiping may scratch the surface.
- To clean the lens surface, first brush away any dust or sand then, if necessary, moisten a lens tissue with lens cleaning fluid and gently wipe the lens in a circular motion, starting from the center.
- Never place lens fluid directly on the lens.
- Never touch the interior of the camera, especially the mirror. Doing so may impair their alignment and movement. Dust on the mirror will not affect the picture quality.
- Never use compressed air to clean the camera's interior, doing so may cause damage to sensitive interior parts.
- Never use organic solvents to clean the camera.
- Never touch the lens surface with your fingers.

### Storage

When storing your camera for extended periods, please follow these guidelines:

- Attach the protective caps.
- Store in a cool, dry, and well-ventilated area away from dust and chemicals such as moth balls. For very long periods, place the camera in an airtight container with a silica gel drying agent.
- Periodically release the camera's shutter to keep it operating properly.
- Before using after prolonged storage, check the camera's operation to make sure it is functioning properly.

### Before Important Events

- Check the camera's operation carefully, or take test photographs.
- Minolta is not responsible for damages incurred by equipment malfunction.

### Questions and Service

- If you have questions about your camera, contact your local camera dealer or write to the Minolta distributor in your area.
- Before shipping your camera for repair, please contact an authorized Minolta Service Facility for details.

### Important Information for Advanced Photo System Camera Owners

The Advanced Photo System includes many possibilities for photography which are not yet available on current photofinishing equipment, even at certified Advanced Photo System Photofinishers. Feature availability will increase as the system moves forward and processing equipment is updated or modified. The Vectis S-1 is already equipped with a number of these functions. We recommend you ask your photofinisher for a list of available services when having your Advanced Photo System film developed.

Functions include;      Print Quantity Selection  
                                     Front Imprinting  
                                     Fixed Time Printing Mode (FTPM)  
                                     Photo Data Recording

#### Technical details of optional V lens 28-56mm f/4-5.6

<b>Elements:</b>	7
<b>Groups:</b>	7
<b>Angle of view:</b>	34°10' - 63°20'
<b>Min. focus distance:</b>	0.35 m (5.5 in)
<b>Max. magnification:</b>	0.18X
<b>Minimum f-stop:</b>	f/32
<b>Filter diameter:</b>	40.5 mm
<b>Dimensions:</b>	ø59 x 52 mm
<b>Weight:</b>	115 g

The specifications are based on the latest information available at the time of printing and are subject to change without notice.

### Camera Type:

IX240 type system camera

### Lens

Minolta V lens

### AF System:

Type: TTL phase-detection system; Sensor: One CCD line sensor; Focus Modes: Autofocus/Manual focus; AF Mode Selection: Single-frame/Continuous drive; Sensitivity: EV 1-19 (ISO 200); AF Illuminator: Flash, Range: 1 - 5m (3.3 - 16 ft.)

### Metering:

Without Flash: 14-segment honeycomb-pattern metering or Spot metering; With Flash: 4-segment TTL direct metering; Range: Honeycomb pattern- EV 3-21 (f/3.5 ISO 200), Spot- EV 6-21 (f/3.5 ISO 200); AE Sensor: Without flash- 14-segment honeycomb-pattern silicon photocell (SPC), With flash- 4-segment SPC

### Shutter:

Type: Electronically controlled, vertical traverse focal-plane; Range: 1/2000 - 30 sec, bulb; Flash Sync: 1/125 sec or slower (1/45 sec with wireless/remote flash)

### Flash:

Type: Built-in, pop-up type with TTL control; Guide Number: 14 (at ISO 200); Coverage: 22mm (Advanced Photo System focal length) Recycling time: 2.5 sec

In P, Portrait, Landscape, and Night Portrait modes: Autoflash in low-light or backlit situations, Manual Fill-flash, and Flash Cancel  
 In Close-up and Sports modes: Autoflash in low light, Manual Fill-flash, and Flash Cancel

In A/S/M modes: Manual Fill-flash and Flash Cancel

### Viewfinder:

Type: SLR type, TTL relay-optical; Field of view: 95%; Magnification: 0.8X; Diopter: -4 to +2 diopters; Eye relief: 25mm from the eyepiece lens

### Film Transport:

Loading: Drop-in loading; Continuous Drive: Approx. 1 frame per sec.; Frame counter: backwards type; Rewind: Automatic and manual

### Film Speed Setting:

Automatic: ISO 25 to ISO 6400; Manual: ISO 6 to ISO 6400

### Splashproof:

Equivalent to IPX2 (IEC standard)

### Power:

Two 3-volt CR2 lithium batteries

### Performance:

Performance is based on Minolta's standard test method using 25 exposure IX240 film, a V 22-80mm f/4-5.6 lens, and fresh batteries. The lens is focused from infinity to 2.0 m and back 2 times and the shutter-release button held partway down for ten seconds before the shutter is released. Exposures are taken at a rate of two rolls per month.

Flash Use	# Rolls at 20°C
none	approx. 25
50% of Exp.	approx. 15
100%	approx. 10

If more operations are performed during use, battery performance will be lower. To maximize battery performance, slide the main switch to lock when the camera is not in use.

### Dimensions:

126.5 X 76.5 X 63.5mm (4.98 X 3.01 X 2.5 in.)

### Weight:

365g (12.87 oz.)

Specifications and accessories are based on the latest information available at the time of printing and are subject to change without notice.



This mark on the bottom of your camera is to inform you that this camera meets the requirements of the EU (European Union) concerning interference causing equipment regulations. CE stands for Conformité Européenne (European Conformity).

Refer to these pages to determine the cause of a problem you are experiencing with your camera. If the information does not cover the problem which you are experiencing or the condition continues, contact your nearest Minolta Service Facility.

### No display appears when the camera is switched on.

- The batteries are loaded incorrectly; remove and reinstall the batteries.
- The batteries are exhausted; install new batteries.
- The camera has malfunctioned; turn the camera off and remove and reinsert the batteries. If normal operation does not resume or the camera malfunctions repeatedly, contact an authorized Minolta Service Facility.

### Autofocus does not work when shutter-release button is pressed partway down.

- The situation is unsuitable for autofocus; use focus hold or manual focus.
- The camera is set to the manual-focus mode; press the focus-mode button to return to autofocus mode.
- The subject is too close; check the minimum focus distance for your lens.

### Shutter can not be released.

- The focus can not be confirmed; use focus hold, or manual focus.
- The camera is attached to a microscope or telescope; contact a Minolta Service Facility for information.

### Flash fires when the shutter-release is pressed partway down.

- The AF illuminator is on; this is a normal camera operation.

### Flash picture is too dark.

- Your subject is beyond the flash range; make sure your subject is within the flash range before taking the picture.

### Lower part of flash picture is dark.

- The lens hood is attached; remove the lens hood before using the built-in flash.

# CAMERA WARNINGS

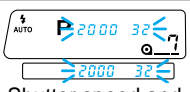
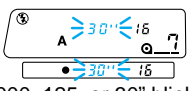
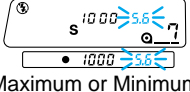
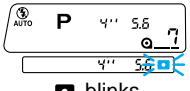
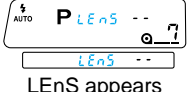
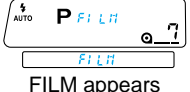
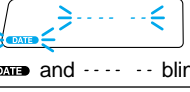
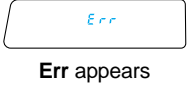
MODE	DISPLAY	CAUSE
P	 Shutter speed and aperture blink	Light level is beyond the range of available shutter speeds and apertures.
A	 2000, 125, or 30" blinks	Required shutter speed is beyond the range of the camera.
S	 Maximum or Minimum aperture blinks	Required aperture is beyond the range of the lens.
Spot	 blinks	Light level is below the camera's minimum metering range.
All	 LEnS appears	Lens is not attached, or is attached improperly.
All	 FILM appears	Film is not loaded.
All	 DATE and ---- -- blink	Date memory can be lost when the batteries are changed.
All	 Err appears	Camera malfunction

ACTION	PAGE
In bright light, attach a neutral density (ND) filter, use film with lower film speed, or reduce the overall brightness of your surroundings. In low-light, use flash or another light source to increase the brightness of your surroundings.	
Select a larger/smaller aperture until the display stops blinking.	56-57
Select a faster/slower shutter speed until the display stops blinking.	59-60
Use higher speed film, increase the brightness, cancel spot metering.	82-83
Attach the lens, or disconnect and reattach the lens. If the camera is attached to a microscope or telescope; contact a Minolta Service Facility for information.	22
Load film.	27
Reset the date and time.	67
Turn the camera off, then remove and reinsert the batteries. If normal operation does not resume or the camera malfunctions repeatedly, contact an authorized Minolta Service Facility.	20

# QUICK REFERENCE GUIDE

Program reset

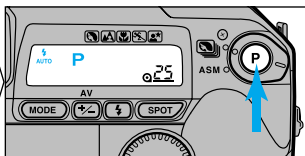

Select a subject program mode

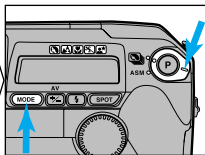

- Portrait Mode
- Landscape Mode
- Close-up Mode
- Sports Mode
- Night Portrait Mode

Set manual fill-flash

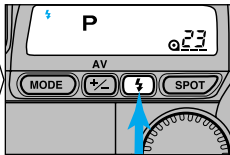

Set flash cancel

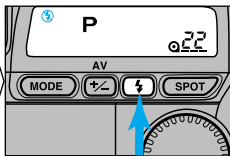

Set red-eye reduction

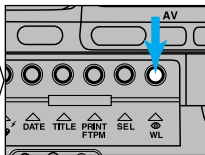

Preselecting a title

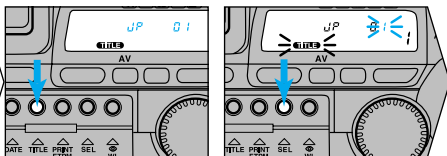

Imprinting a title

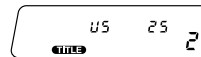
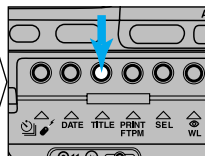

Imprinting the date/time

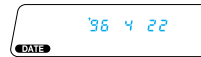
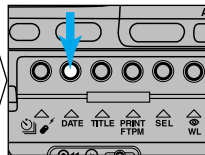

Setting the print quantity

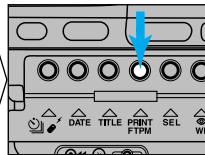

Setting a filmstrip title

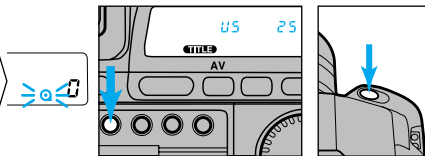

Manual rewind

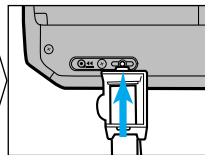



<b>Minolta Co. Ltd.</b>	<b>3-13, 2-Chome, Azuchi-Machi, Chuo-Ku, Osaka 541-8556, Japan</b>
<b>Minolta GmbH</b>	Kurt-Fischer-Strasse 50, D-22923 Ahrensburg, Germany
<b>Minolta France S.A.</b>	365 Route de Saint-Germain, F-78420 Carrières-Sur-Seine, France
<b>Minolta (UK) Limited</b>	7 Tanners Drive, Blakelands, Milton Keynes, MK14 5BU, England
<b>Minolta Austria Ges. m.b.H.</b>	Amalienstrasse 59-61, A-1131 Wien, Austria
<b>Minolta Camera Benelux B.V.</b>	Zonnebaan 39, P.O. Box 6000, NL-3600 HA Maarsse, The Netherlands
<b>Belgium Branch</b>	Kontichsesteenweg 38, B-2630 Aartselaar, Belgium
<b>Minolta (Schweiz) AG</b>	Riedstrasse 6, CH-8953 Dietikon, Switzerland
<b>Minolta Svenska AB</b>	Albygatan 114, S-171 54 Solna, Sweden
<b>Finland Branch</b>	Niittykatu 6 PL 37, SF-02201 Espoo, Finland
<b>Minolta Portugal Limitada</b>	Av. do Brasil 33-A, P-1700 Lisboa, Portugal
<b>Minolta Corporation</b>	
<b>Head Office</b>	101 Williams Drive, Ramsey, New Jersey 07446, U.S.A.
<b>Los Angeles Branch</b>	11150 Hope Street Cypress, CA 90630, U.S.A.
<b>Minolta Canada Inc.</b>	
<b>Head Office</b>	369 Britannia Road East, Mississauga, Ontario L4Z 2H5, Canada
<b>Vancouver Branch</b>	230-3771 Jacombs Road, Richmond, B.C. V6V 2L9, Canada
<b>Minolta Hong Kong Limited</b>	Room 208, 2/F, Eastern Center, 1065 King's Road, Quarry Bay, Hong Kong
<b>Minolta Singapore (Pte) Ltd.</b>	10, Teban Gardens Crescent, Singapore 608923
<b>Shanghai Minolta Optical Products Co., Ltd.</b>	368 Minolta Road, Songjiang, Shanghai, China

© 1996 Minolta Co., Ltd. under the Berne Convention and  
Universal Copyright Convention