

TOSHIBA

OWNER'S MANUAL

3LCD PROJECTOR

TLP-MT7E

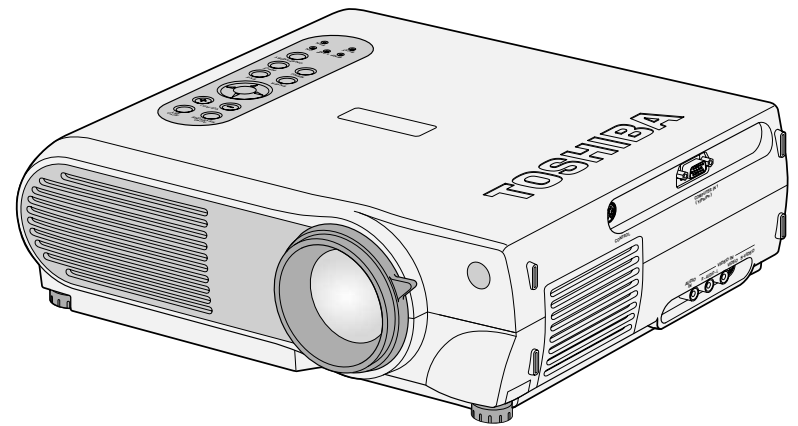

SAFETY PRECAUTIONS

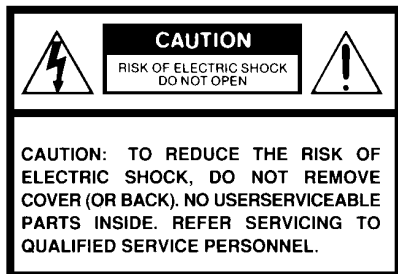

WARNING: TO REDUCE THE RISK OF FIRE OR ELECTRIC SHOCK, DO NOT EXPOSE THIS APPLIANCE TO RAIN OR MOISTURE. DANGEROUS HIGH VOLTAGES ARE PRESENT INSIDE THE ENCLOSURE. DO NOT OPEN THE CABINET. REFER SERVICING TO QUALIFIED PERSONNEL ONLY.



The lightning flash with arrowhead symbol, within an equilateral triangle, is intended to alert the user to the presence of uninsulated “dangerous voltage” within the product’s enclosure that may be of sufficient magnitude to constitute a risk of electric shock to persons.



The exclamation point within an equilateral triangle is intended to alert the user to the presence of important operating and maintenance (servicing) instructions in the literature accompanying the appliance.

IMPORTANT PRECAUTIONS

Save Original Packing Materials

The original shipping carton and packing materials will come in handy if you ever have to ship your LCD projector. For maximum protection, repack the set as it was originally packed at the factory.

Avoid Volatile Liquid

Do not use volatile liquids, such as an insect spray, near the unit. Do not leave rubber or plastic products touching the unit for a long time. They will mar the finish.

Moisture Condensation

Never operate this unit immediately after moving it from a cold location to a warm location. When the unit is exposed to such a change in temperature, moisture may condense on the crucial internal parts. To prevent the unit from possible damage, do not use the unit for at least 2 hours when there is an extreme or sudden change in temperature.

In the spaces provided below, record the Model and Serial No. located at the bottom of your LCD projector.

Model No. _____ Serial No. _____

Retain this information for future reference.

IMPORTANT SAFETY INSTRUCTIONS

CAUTION: PLEASE READ AND OBSERVE ALL WARNINGS AND INSTRUCTIONS GIVEN IN THIS OWNER'S MANUAL AND THOSE MARKED ON THE UNIT. RETAIN THIS BOOKLET FOR FUTURE REFERENCE.

This set has been designed and manufactured to assure personal safety. Improper use can result in electric shock or fire hazard. The safeguards incorporated in this unit will protect you if you observe the following procedures for installation, use and servicing. This unit is fully transistorized and does not contain any parts that can be repaired by the user.

DO NOT REMOVE THE CABINET COVER, OR YOU MAY BE EXPOSED TO DANGEROUS VOLTAGE. REFER SERVICING TO QUALIFIED SERVICE PERSONNEL ONLY.

1. Read Owner's Manual

After unpacking this product, read the owner's manual carefully, and follow all the operating and other instructions.



2. Power Sources

This product should be operated only from the type of power source indicated on the marking label. If you are not sure of the type of power supply to your home, consult your product dealer or local power company. For products intended to operate from battery power, or other sources, refer to the operating instructions.



3. Source of Light

Do not look into the lens while the lamp is on. The strong light from the lamp may cause damage to your eyes or sight.

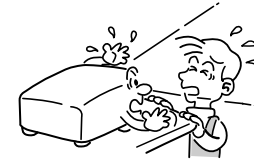

4. Ventilation

Openings in the cabinet are provided for ventilation and to ensure reliable operation of the product and to protect it from overheating, and these openings must not be blocked or covered. The openings should never be blocked by placing the product on a bed, sofa, rug or other similar surface. This product should not be placed in a built-in installation such as a bookcase or rack unless proper ventilation is provided or the manufacturer's instructions have been adhered to.

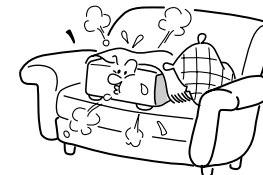

IMPORTANT SAFETY INSTRUCTIONS (continued)

5. Heat

The product should be situated away from heat sources such as radiators, heat registers, stoves, or other products (including amplifiers) that produce heat.

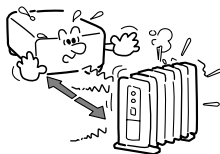

7. Cleaning

Unplug this product from the wall outlet before cleaning. Do not use liquid cleaners or aerosol cleaners. Use a damp cloth for cleaning.

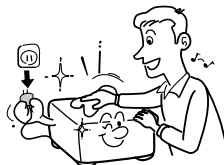

9. Overloading

Do not overload wall outlets; extension cords, or integral convenience receptacles as this can result in a risk of fire or electric shock.



6. Water and Moisture

Do not use this product near water – for example, near a bath tub, wash bowl, kitchen sink, or laundry tub; in a wet basement; or near a swimming pool and the like.

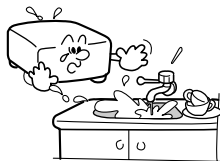

8. Power-Cord Protection

Power-supply cords should be routed so that they are not likely to be walked on or pinched by items placed upon or against them, paying particular attention to cords at plugs, convenience receptacles, and the point where they exit from the product.



10. Lightning

For added protection for this product during storm, or when it is left unattended and unused for long periods of time, unplug it from the wall outlet. This will prevent damage to the product due to lightning and power-line surges.



IMPORTANT SAFETY INSTRUCTIONS (continued)

11. Object and Liquid Entry

Never push objects of any kind into this product through openings as they may touch dangerous voltage points or short-out parts that could result in a fire or electric shock. Never spill liquid of any kind on the product.



12. Do not place the product vertically

Do not use the product in the upright position to project the pictures at the ceiling, or any other vertical positions. It may fall down and dangerous.

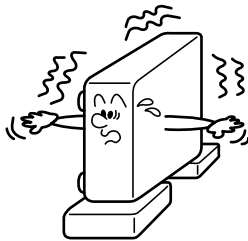

13. Stack Inhibited

Do not stack other equipment on this product or do not place this product on the other equipment. Top and bottom plates of this product develops heat and may give some undesirable damage to other unit.

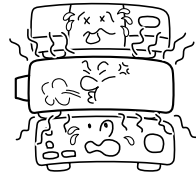

14. Attachments

Do not use attachments not recommended by the product manufacturer as they may cause hazards.

15. Accessories

Do not place this product on an unstable cart, stand, tripod, bracket, or table. The product may fall, causing serious injury to a child or adult, and serious damage to the product. Use only with a cart, stand, tripod, bracket, or table recommended by the manufacturer, or sold with the product. Any mounting of the product should follow the manufacturer's instructions, and should use a mounting accessory recommended by the manufacturer. A product and cart combination should be moved with care. Quick stops, excessive force, and uneven surfaces may cause the product and cart combination to overturn.



IMPORTANT SAFETY INSTRUCTIONS (continued)

16. Damage Requiring Service

Unplug this product from the wall outlet and refer servicing to qualified service personnel under the following conditions:

- a) When the power-supply cord or plug is damaged.
- b) If liquid has been spilled, or objects have fallen into the product.
- c) If the product has been exposed to rain or water.
- d) If the product does not operate normally by following the operating instructions. Adjust only those controls that are covered by the operating instructions as an improper adjustment of other controls may result in damage and will often require extensive work by a qualified technician to restore the product to its normal operation.
- e) If the product has been dropped or damaged in any way.
- f) When the product exhibits a distinct change in performance – this indicates a need for service.

17. If glass components, including lens and lamp, should break, contact your dealer for repair service.

This product incorporates glass components, including a lens and a lamp. If such parts should break, please handle with care to avoid injury and contact your dealer for repair service. The broken pieces of glass may cause to injury.

In the unlikely event of the lamp rupturing, thoroughly clean the area around the projector and discard any edible items placed in that area.

18. Servicing

Do not attempt to service this product yourself as opening or removing covers may expose you to dangerous voltage or other hazards. Refer all servicing to qualified service personnel.



19. Replacement Parts

When replacement parts are required, be sure the service technician has used replacement parts specified by the manufacturer or have the same characteristics as the original part. Unauthorized substitutions may result in fire, electric shock, or other hazards. (Replacement of the lamp only should be made by users.)

20. Safety Check

Upon completion of any service or repairs to this product, ask the service technician to perform safety checks to determine that the product is in proper operating condition.

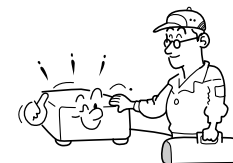

Power supply cord selection

If your line voltage is 220 to 240V, use one of the following types of cable.

In Singapore, use the UK type plug cable.
(The UK type plug [MP5004] of this model is approved by PSB.)

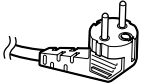
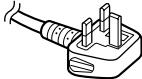
Plug configuration	Plug type	Line voltage
	EURO	220 – 240V
	UK	220 – 240V

Use a 5A fuse which is approved by ASTA or BSI to BSI362.

Always replace the fuse cover after changing the fuse.

Before use

<i>SAFETY PRECAUTIONS</i>	2
<i>IMPORTANT PRECAUTIONS</i>	3
<i>IMPORTANT SAFETY INSTRUCTIONS</i>	4
<i>Power supply cord selection</i>	8
<i>Contents</i>	9
<i>Names of each part on the main unit</i>	10
<i>Names of each part on the remote control</i>	13
<i>Loading batteries</i>	14
<i>Remote control operation</i>	15

Installation and connections

<i>Floor-mounted projector placement</i>	16
<i>Projector placement angle adjustment</i>	19
<i>Ceiling-mounted projector placement</i>	20
<i>Connecting video equipment</i>	21
<i>Connecting a computer</i>	23
<i>Projector operation control by a computer</i>	24

Operations

<i>Projection on the screen</i>	25
<i>Turning the power off</i>	28
<i>Correcting the keystone distortion</i>	29
<i>Enlarging the picture size</i>	30
<i>Cutting off the picture and sound temporarily</i>	31
<i>Freezing the picture</i>	32
<i>Adjusting the picture automatically (computer input)</i>	33
<i>Displaying PIP Sub-pictures</i>	34
<i>Displaying Information</i>	35

Adjustments & Settings

<i>Adjustments and settings on the menu screen</i>	36
<i>Operating the menu screen</i>	37
<i>QUICK MENU adjustments and settings</i>	38
<i>FULL MENU adjustments and settings – Picture</i>	44
<i>FULL MENU settings – Audio</i>	50
<i>FULL MENU settings – Keystone</i>	52
<i>FULL MENU settings – Display</i>	54
<i>FULL MENU settings – Default setting</i>	57
<i>FULL MENU settings – Factory reset mode</i>	61
<i>PIP menu setting</i>	63

Maintenance

<i>Trouble indications</i>	64
<i>Air filter cleaning</i>	65
<i>Lens and main unit cleaning</i>	67
<i>Lamp replacement</i>	68

Others

<i>Before calling service personal</i>	70
<i>Pin assignment of COMPONENT IN connector</i>	72
<i>Applicable signal</i>	73
<i>Controlling the projector by using RS-232C</i>	75
<i>Specifications</i>	80

Names of each part on the main unit

CAUTION

Openings in the cabinet are provided for ventilation and to ensure reliable operation of the product and to protect it from overheating, and these openings must not be blocked or covered.

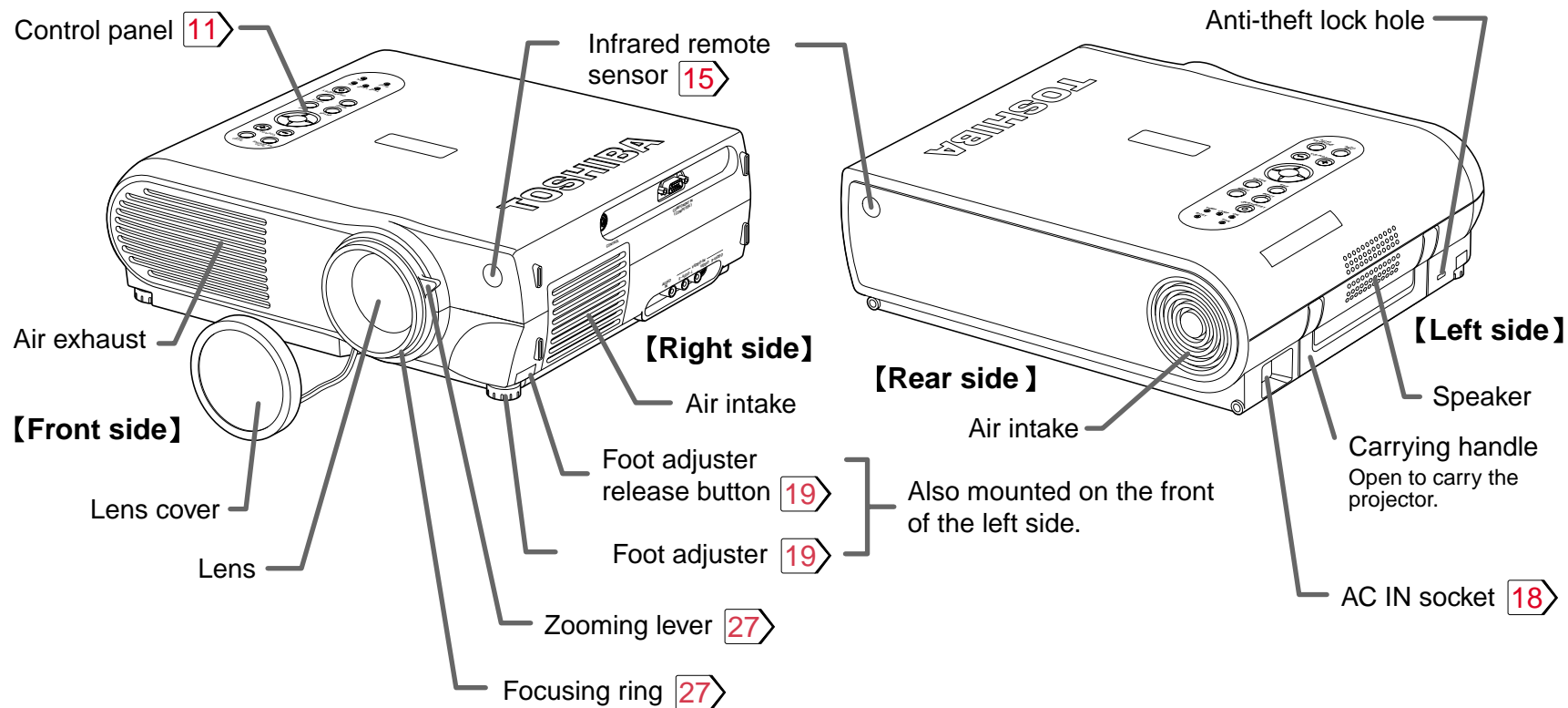

Note

The air exhaust discharges high temperature air. Do not put something around the air exhaust, otherwise it may be deformed by the high temperature air.

Names of each part on the main unit (continued)

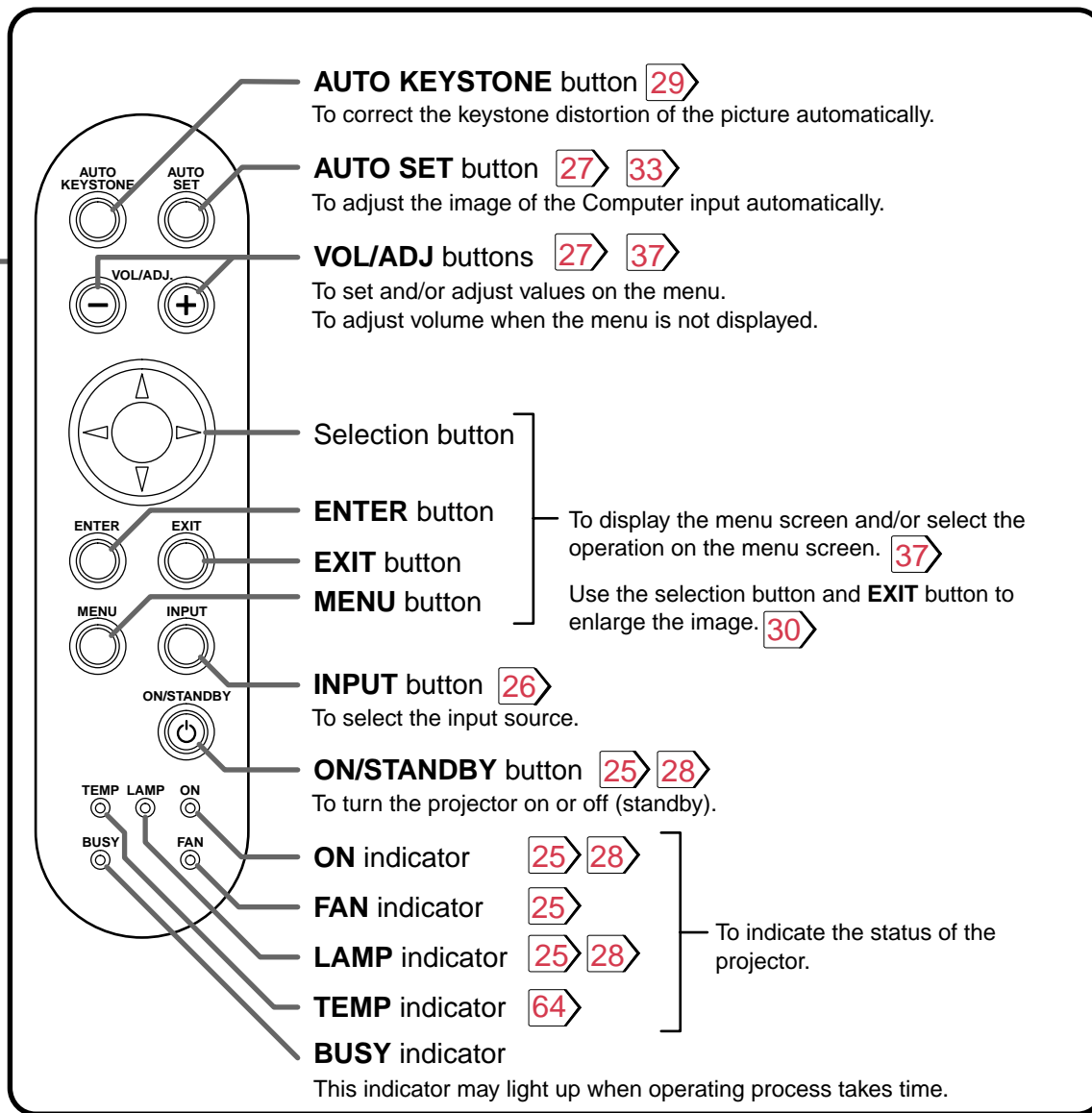
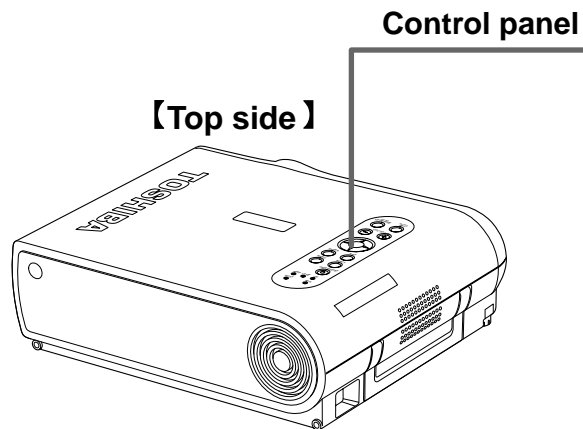

Names of each part on the main unit (continued)

CONTROL connector 24
 (RS-232C connector)
 To connect a computer to
 control the projector.

[Right side]

COMPONENT IN connector 21 23
 To enter component video signal (Y/Pb/Pr Signal)
 from a video equipment or RGB signal from a
 computer, etc.

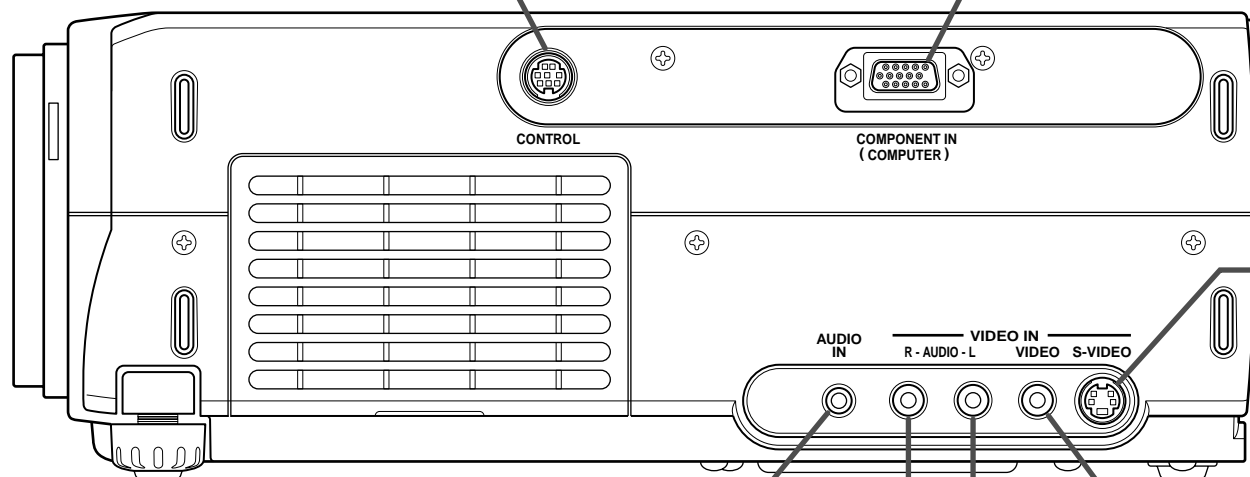

AUDIO IN jack (Audio input) 21 23
 (ø3.5mm stereo mini-jack)
 To enter audio signal from a computer or a video
 equipment with component video output
 (Y/Pb/Pr signal output) supported or a computer.

S-VIDEO connector 22
 To enter S-video signal
 from a video equipment, etc.

VIDEO jack 22
 To enter video signal
 from a video equipment, etc.

AUDIO(L/R) jacks 22
 To enter audio signal from a video
 equipment, etc.

Names of each part on the remote control

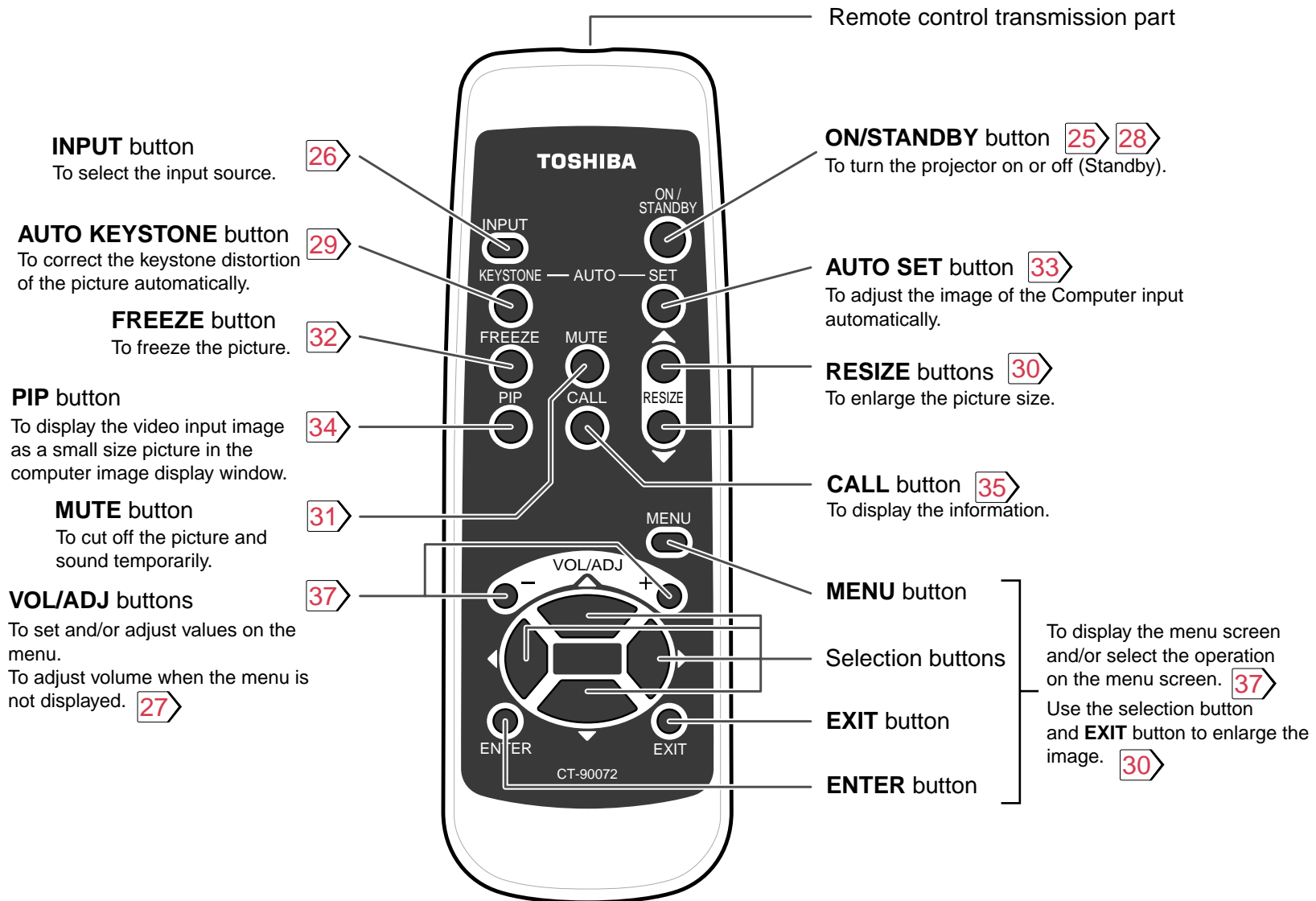

Loading batteries

Notes

Using batteries incorrectly can cause them to leak or burst. Strictly observe the following.

- Install the batteries with their + and – ends facing correctly.
- Do not charge, heat, disassemble, or short the batteries or throw them into a fire.
- Do not leave exhausted batteries in the remote control.
- Do not mix different types of batteries or new and old batteries.
- When you will not be using the remote control for a prolonged period, take the batteries out of the remote control.
- When the remote control stops working or only works from very close distance, replace all the batteries with new ones.
- When replacing the batteries, use a more longer life alkaline batteries.
- If a battery leaks, carefully wipe off any residue inside the battery case before loading new batteries.

1

【 Bottom Side 】

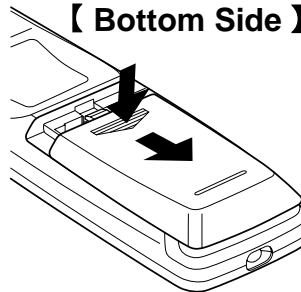
Open the cover.

2

Install the batteries.

Make sure that the +/- polarities match the illustration in the compartment.

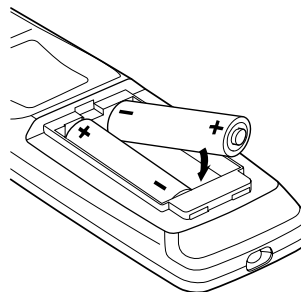

3

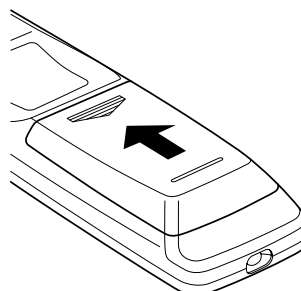
Attach the cover.

Remote control operation

Point the remote control at the infrared remote sensor and press a button.

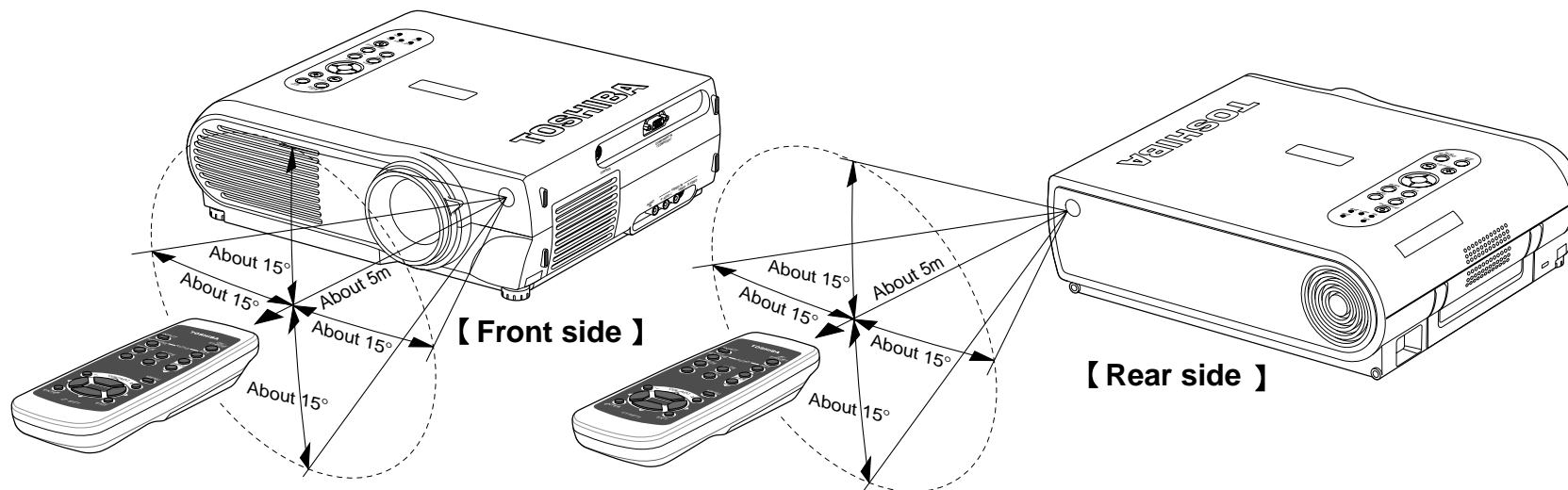

Notes

- The remote control may not operate when there is sunlight or other strong light such as a fluorescent lamp shining on the remote sensor.
- Operate the remote control from a position where the remote sensor is visible.
- Do not drop the remote control or otherwise jolt it.
- Keep the remote control out of locations with excessively high temperature or humidity.
- Do not get water on the remote control or place wet objects on it.
- Do not disassemble the remote control.
- Under unusual circumstances the remote control may not operate well due to the location being used or the surroundings. At such times, change the direction of the remote control to the projector and retry the operation.

Floor-mounted projector placement

There are two ways to place the floor-mounted projector. Perform the “Projection mode” setting on the menu screen for the projection method. [59](#)

For the ceiling-mounted projector placement, refer to the page [20](#).

Floor-mounted front projection

Viewing a picture projected on the front of the screen from a floor installation.

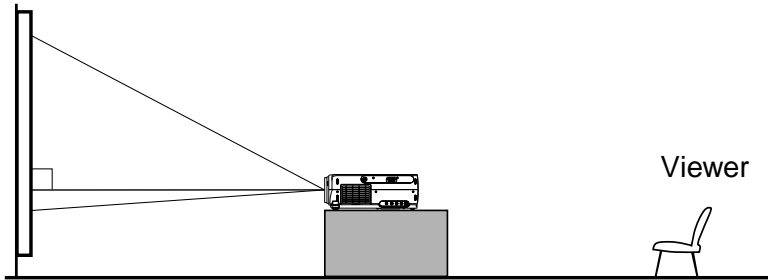

Floor-mounted rear projection

Viewing a picture projected through the back of the screen from a floor installation.

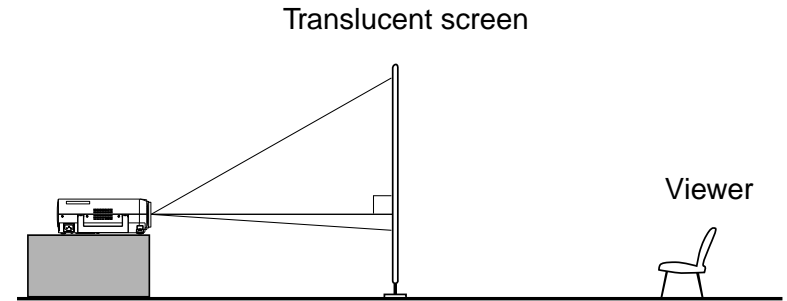

Floor-mounted projector placement (continued)

1 Place the projector on a steady, level surface such as a table.

To obtain proper screen projected, place the projector so that the projecting light hits the screen squarely.

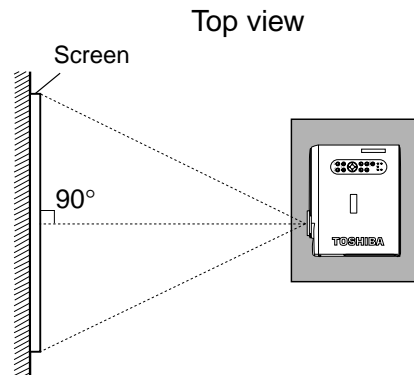

Point the lens straight at the center of the screen as above.

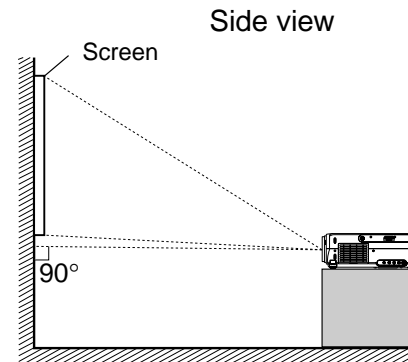

Place the projector horizontally so that the projecting light hits the screen squarely.

2 Determine the screen size projected on the screen.

The projection size depends on the distance between the lens and the screen. Adjust the projection size by changing the distances as shown below.

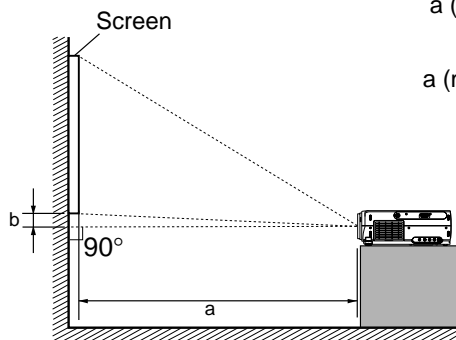

$$a \text{ (min.)} = \frac{\text{Projection size} - 0.8660}{25.339}$$

$$a \text{ (max.)} = \frac{\text{Projection size} - 0.6766}{19.796}$$

$$b = \text{Projection size} - (\text{cm}) \times 0.143$$

a: Distance between the lens and the screen (m)

b: Distance between the lens height and the bottom of projection area (cm)

• The values are approximations.

Projection size (inches)	a(m)		b(cm)
	Minimum (At maximum zoom)	Maximum (At minimum zoom)	
28	-	1.38	10
32	1.23	1.58	12
36	1.39	1.78	13
42	1.62	2.09	15
60	2.33	3.00	22
80	3.12	4.01	29
100	3.91	5.02	36
150	5.89	7.54	55
200	7.86	10.07	73
250	9.83	-	91

Continued

Floor-mounted projector placement (continued)

3

Connect the power cord.

- Insert one end in the AC IN socket on the projector.
- Insert the other end in a wall outlet.

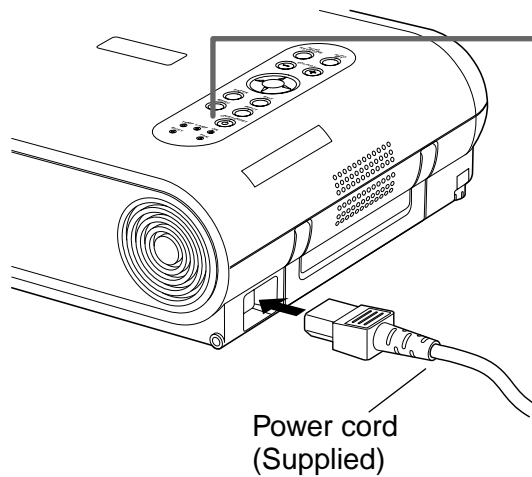

Light (Orange)

The three indicators, TEMP, LAMP, and ON, light in green for several seconds and then the ON indicator lights in orange and the projector turns to the standby mode.

Do not perform any operations while the three indicators are lit green.

4

Take off the lens cover.

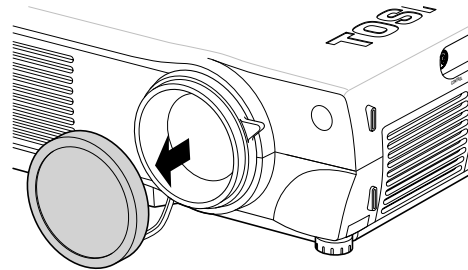

Notes

- When the projector is moved from a cold location to a warm location, or when the ambient temperature in the projection room has risen suddenly, moisture may condense on the lens or the internal optical section to blur the projected pictures. In such a case, leave the projector for an adequate time (1 to 2 hours, depending on the room's condition) before using it, so it adjusts to the ambient temperature.
- If the screen is exposed to direct sunlight or other strong light, the projected picture becomes too faint to see. Shut out the light with curtains or other means.
- If the screen and the projector are not installed properly, the projected picture may be distorted.

Projector placement angle adjustment

The tilt of the projector can be adjusted using the foot adjuster.

1

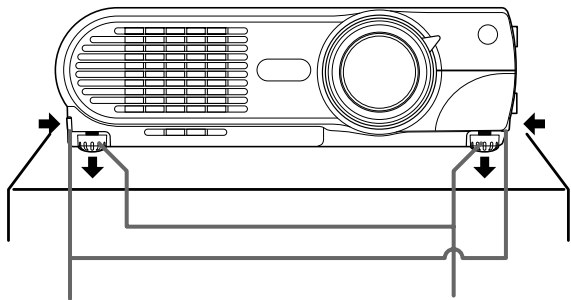

Foot adjuster
release button

Foot adjuster

Lift the front of the projector until a tilt angle desired is obtained and hold down the foot adjuster release button.

The foot adjuster will stretch.
Release the button to lock in position.

2

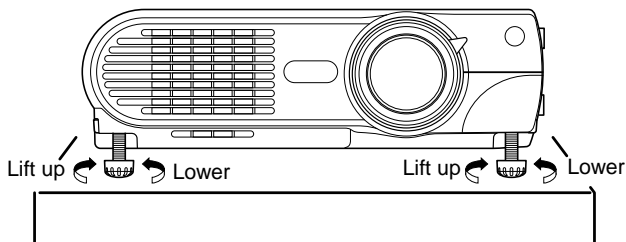

Lift up Lower

Lift up Lower

Turn the foot adjuster to make fine adjustment of the height.

Turn clockwise to lift up.
Turn counterclockwise to lower.

Notes

- To put the foot adjuster back, hold down the foot adjuster release button and lower the front slowly.
- Be sure to hold the projector when putting the foot adjuster back so as not to let the front fall on your fingers.
- Do not tilt the projector at an angle exceeding the range adjustable by the foot adjusters, since the duration life of the lamp may be shortened.

Ceiling-mounted projector placement

CAUTION

When a ceiling mount is required, please consult with the dealer.

Ceiling-mounted front projection

Viewing a picture projected on the front of the screen from a ceiling installation.

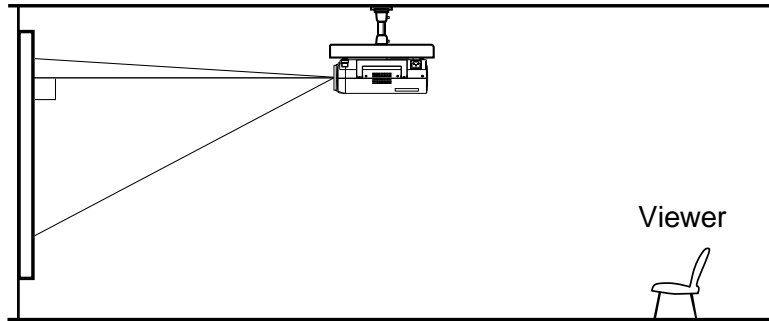

Ceiling-mounted rear projection

Viewing a picture projected through the back of the screen from a ceiling installation.

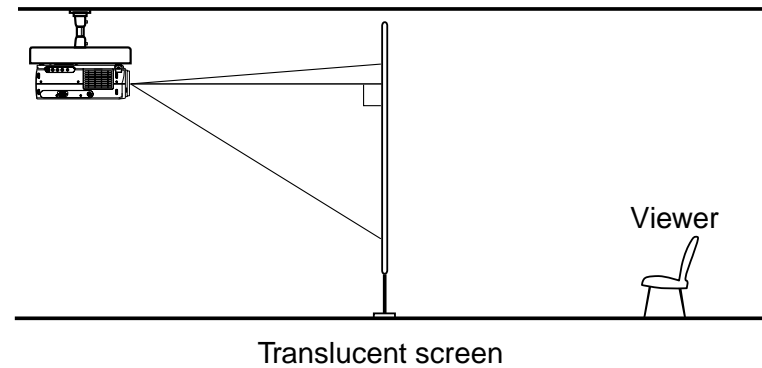

Perform the "Projection mode" setting on the menu screen for the projection method. [59](#)

Note

The relation between the projection size and the distance to the screen is the same as that of the floor-mounted projection mode [16](#).

Connecting video equipment

You can project the picture from video equipment with component video output jack.
Check that the power for the projector and video equipment is off before connecting the cables.

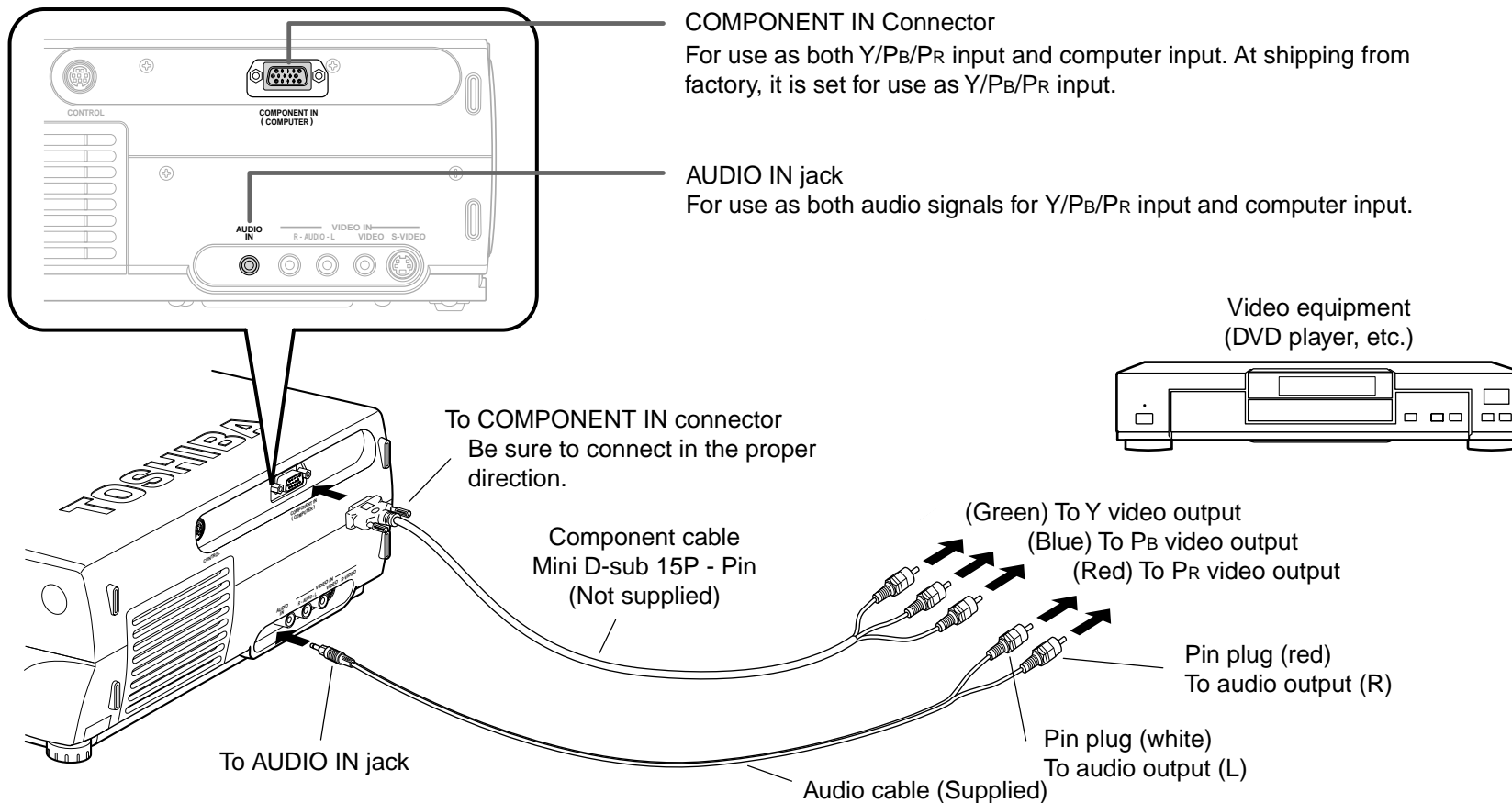

Connecting video equipment (continued)

You can project the picture from video equipment by using VIDEO IN connectors.
Check that the power for the projector and video equipment is off before connecting the cables.

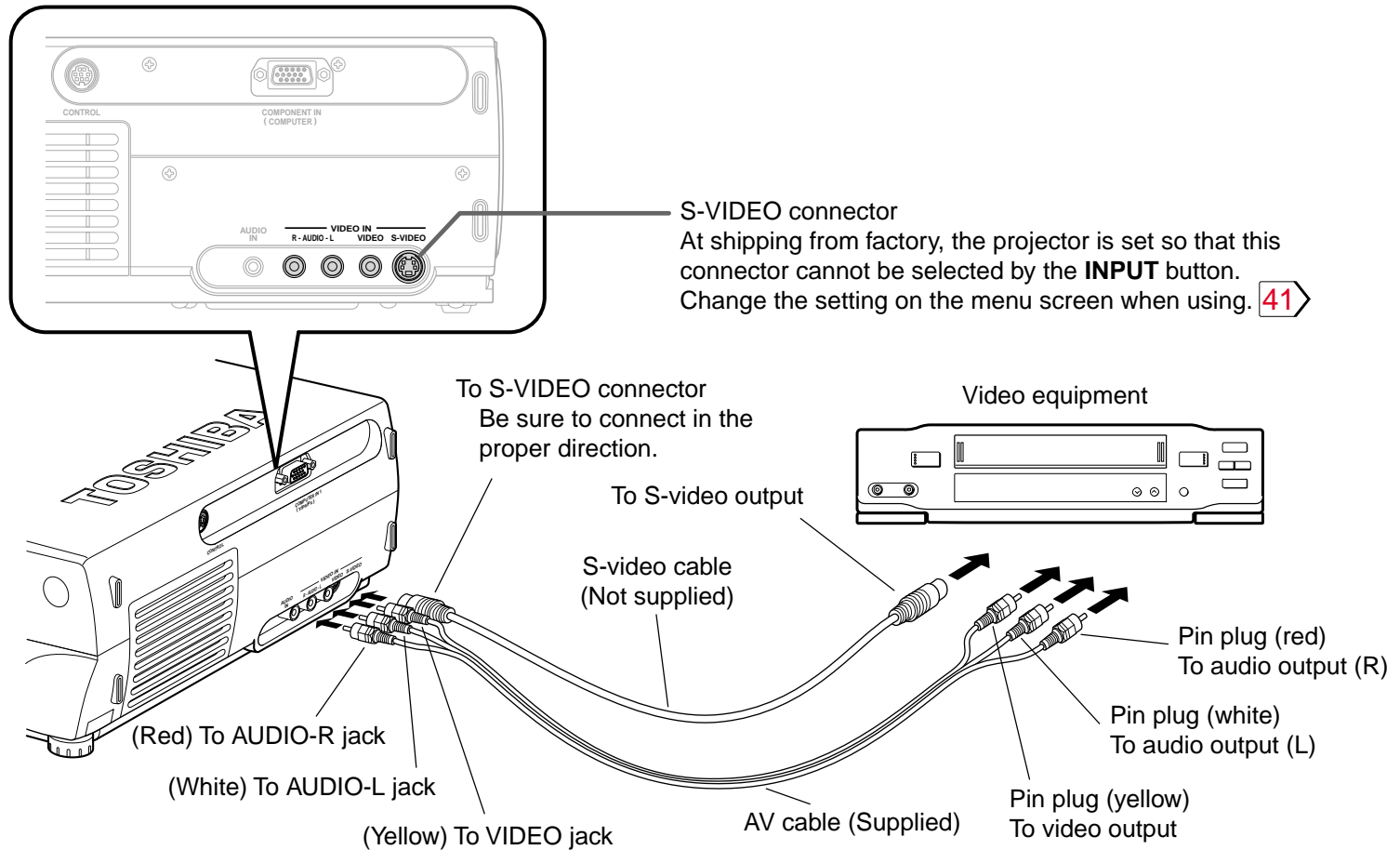

Note

The S-VIDEO connector and VIDEO jack can be used independently, but the audio input jacks are used as both the S-VIDEO and VIDEO input.

Connecting a computer

You can project the picture from the computer.

Check that the power for the projector and computer is off before connecting the cables.

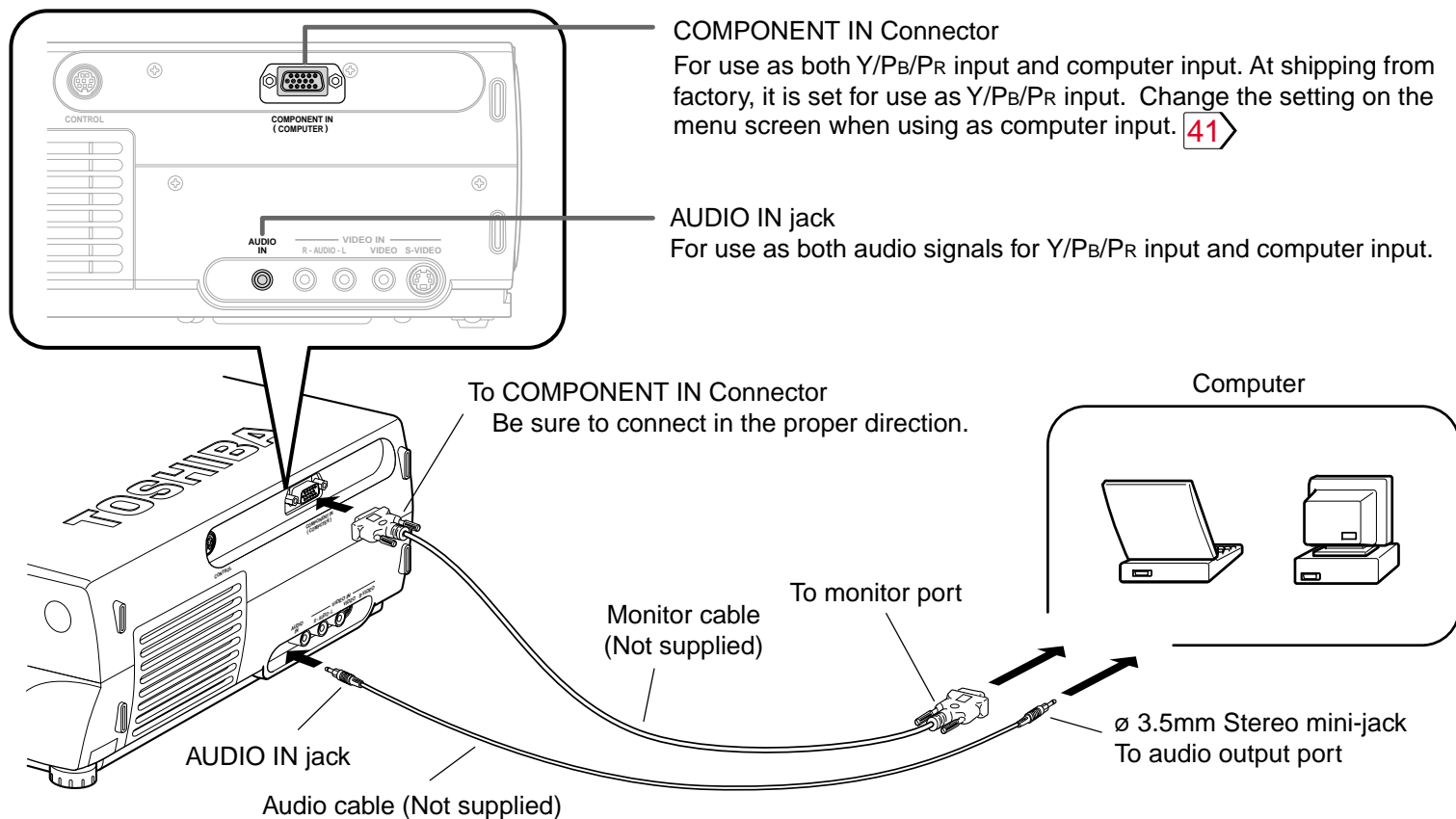

Notes

- The projector cannot be connected to a computer without an analog RGB connector. For details, refer to the computer manual.
- You may not be able to connect some computers to the projector. For details, consult the dealer.
- Some computers may have output modes which are not compatible with this projector. Check the compatibility of the connectors, signal levels, timing, resolutions, etc.

Projector operation control by a computer

You can control the projector by a computer connected with the control cable supplied. **75**
Check that the power for the projector and computer is off before connecting the cables.

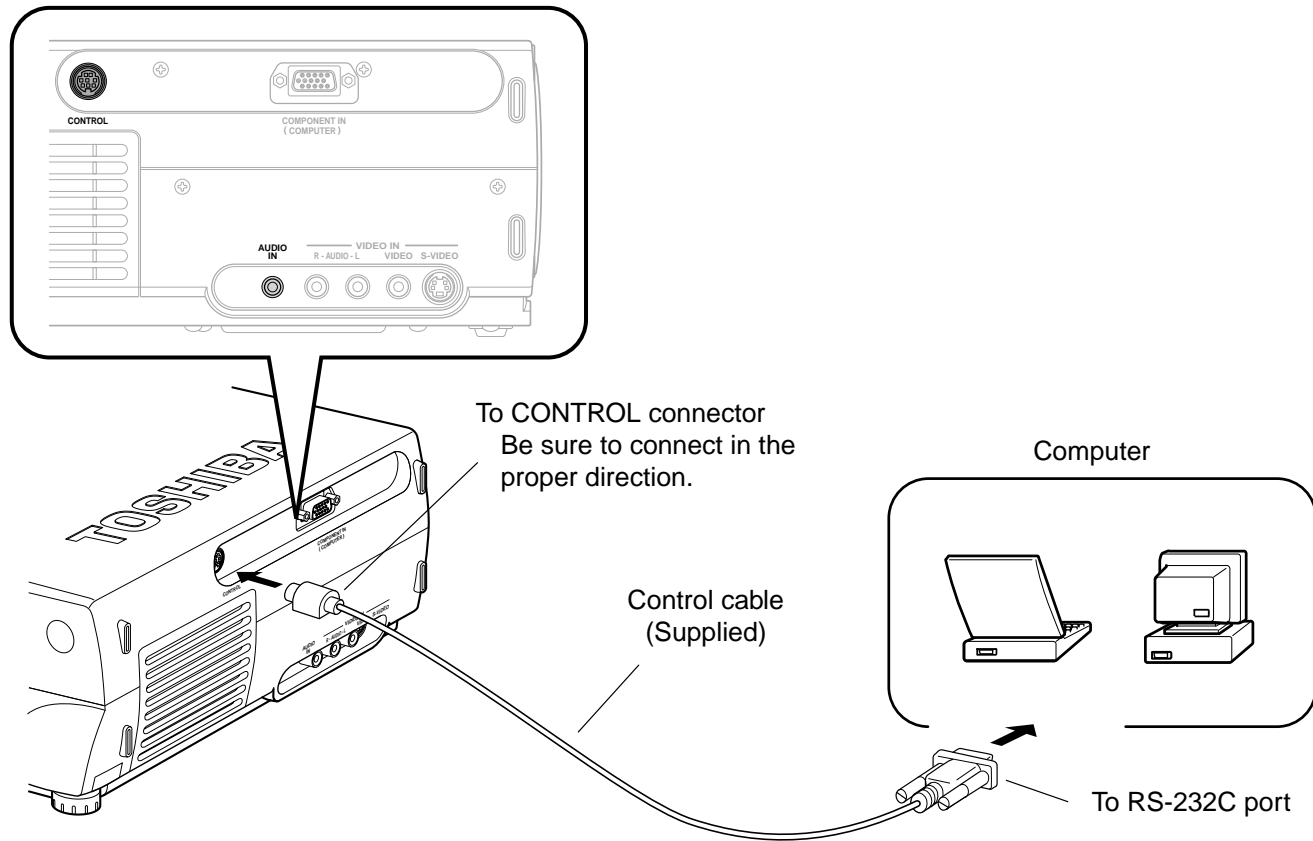

Note

Do not connect a cable other than the exclusive one supplied.

Projection on the screen

CAUTION – Do not look into the projection lens while operating the projector.

Remote control

Control panel
(Main unit side)

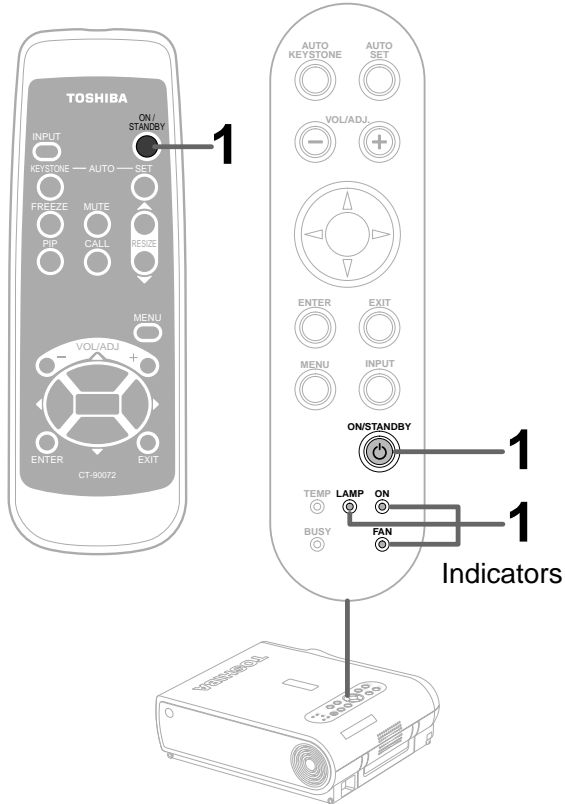

Preparation

- 1 Install and connect the projector properly.
- 2 Take off the lens cover.

1

ON/STANDBY



ON/
STANDBY



Press ON/STANDBY.

The projector turns on and the ON, LAMP and FAN indicators light in green.

(The LAMP indicator blinks while the lamp is warming up.)

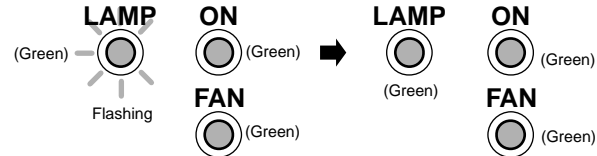

The lamp lights and the start up display appears.

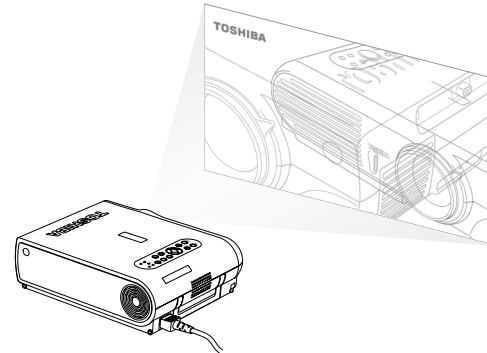

2



Turn on the connected equipment and put it in playback mode.

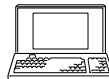

Select "Cancel" when the dialog box of Add New Hardware Wizard screen appears on the computer when connecting a computer.

Projection on the screen (continued)

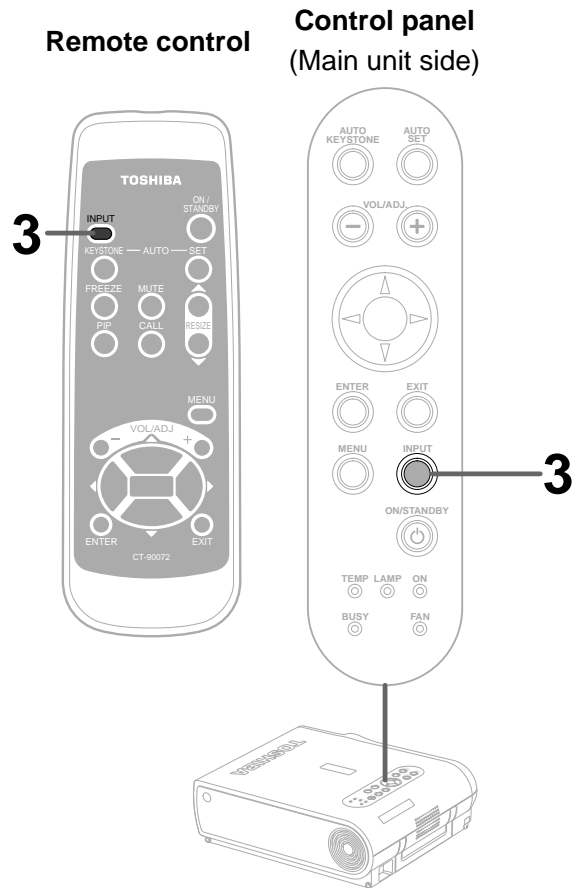

3

INPUT



INPUT



Y/Pb/Pr



Video



S-Video



Computer



Select the input source.

Press the **INPUT** button repeatedly to select it.
The icon of the input source selected appears.

Note

The types of input sources selected when the **INPUT** button is pressed repeatedly can be set from the menu screen. [38](#)

(At shipping from factory, the projector is set so that the component signal source input to the COMPONENT IN connector and the video signal source input to the VIDEO jack can be selected.)



(Signal sent from the computer)

- If you project an image from a computer with an LCD screen while monitoring the image on the computer, the image may not be projected properly, depending on the computer model. In this case, turn off the computer display. For details on controlling the computer display, etc., refer to the computer's manual and description on the software for the computer used.
- An image on a computer is displayed enlarged or reduced, so quality of the screen becomes a bit inferior.
- The projector can be also applied to DDC2B (Display Data Channel 2B). If your computer is applied to the DDC, start up your computer after turning on the projector.

Projection on the screen (continued)

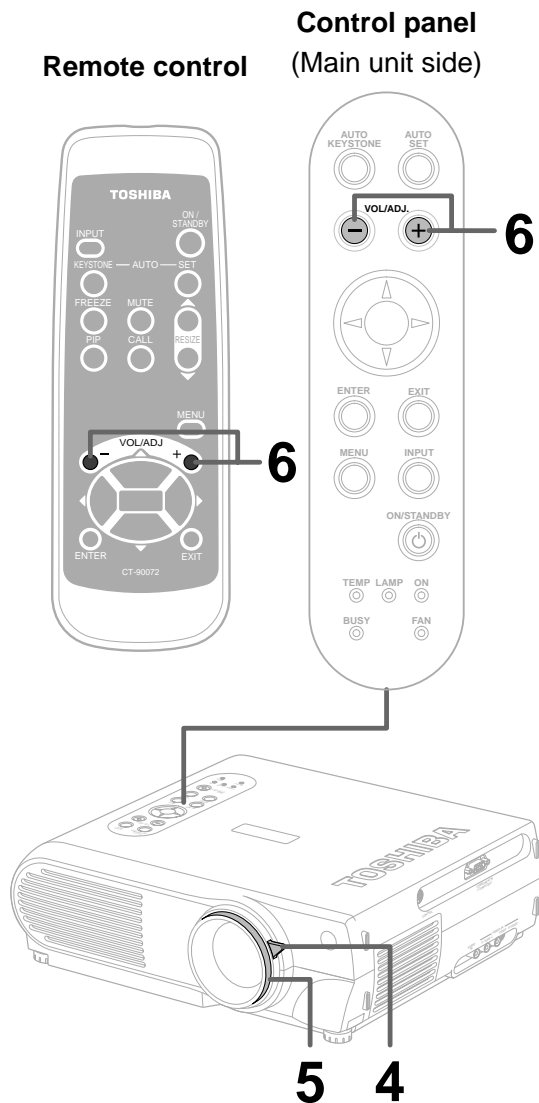

4

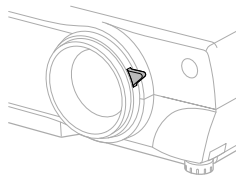

Adjust the picture size by turning the zooming lever.

Turn to the right to enlarge the picture.
Turn to the left to reduce the picture.

5

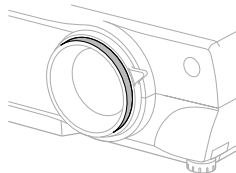

Focus on the picture by turning the focusing ring.

A still picture is recommended for focusing.

6

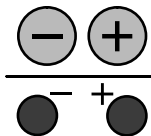



Press VOL/ADJ (+/-) to adjust volume.

Press the (+) button to increase volume.
Press the (-) button to decrease volume.
The volume adjusting bar and the icon appear.



Notes

- When changing the projecting angle, adjust the foot adjuster. [19](#)
- When the screen image is distorted in keystone, press the **AUTO KEYSTONE** button. [29](#)
- The projector may stop operating if the surrounding temperature is too high or if the air filter is clogged with dust. [64](#)
- Due to the lamp characteristic, flickers may occasionally occur in a picture. This is not malfunction of the unit.
- The projector's liquid crystal panel is made using extremely advanced technology, but there may be black spots (pixels that do not light) or bright spots (pixels that are constantly lit) on the panel. Please note that these are not malfunctions.
- When trying to press the button whose operation is not available, the icon  appears.
- When supplying the signal not compatible to the projector, the icon  appears.
- When signals are not input from the input source, the icon  appears.

Turning the power off

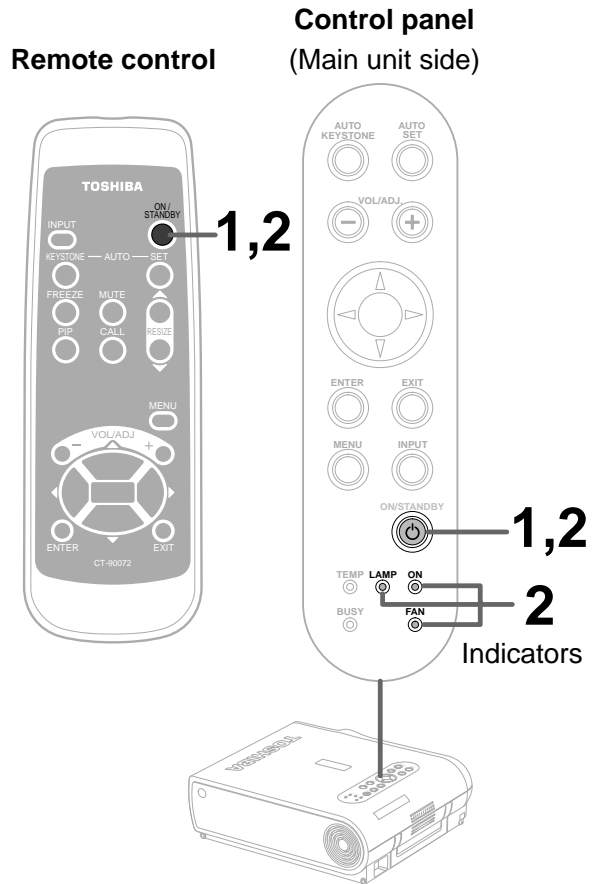

1

ON/STANDBY

ON/
STANDBY

Press ON/STANDBY after using the projector.

An instruction message appears.

2

ON/STANDBY

ON/
STANDBY

Press ON/STANDBY again.

Cooling starts. Once cooling is completed, the LAMP and FAN indicators turn off and the standby mode is set. (The ON indicator turns in orange.)

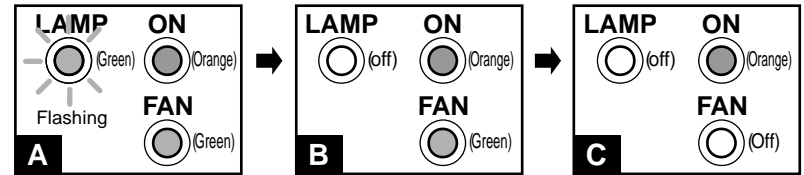

A To protect the light source lamp, the LAMP indicator blinks as long as a minimum of cooling is necessary. The power cannot be turned back on during this time. Unplugging the power cord at this time will shorten the lamp's duration life.

B The cooling fan continues to run for a while to expel the heat remaining inside. If you are in a hurry, however, you may unplug the power cord at this time.

C The standby mode is set.

Notes

- The projector consumes about 20W of power in the standby mode. We recommend you to unplug the power cord when not using the projector for long periods of time.
- Be sure that the LAMP indicator has turned off before unplugging the power cord. Cutting the power by unplugging the power cord while the projector is operating or the light source lamp is being cooled will shorten the lamp's duration life. Should fault or some other irregularity arise with this unit, unplug the power cord.
- When reinserting the power plug before the lamp has cooled, please wait until the lamp has cooled sufficiently before use. When the lamp is at a high temperature, it may not light and the duration life will be shortened.

Correcting the keystone distortion

Remote control

Control panel
(Main unit side)

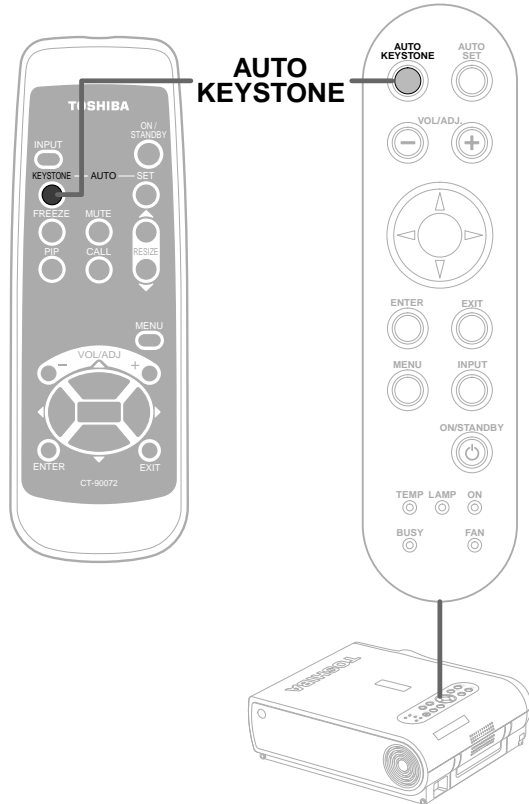

A picture may be expanded on the upper side if projected upward from the projector lifted up by the foot adjuster. The projector can correct this keystone distortion automatically.

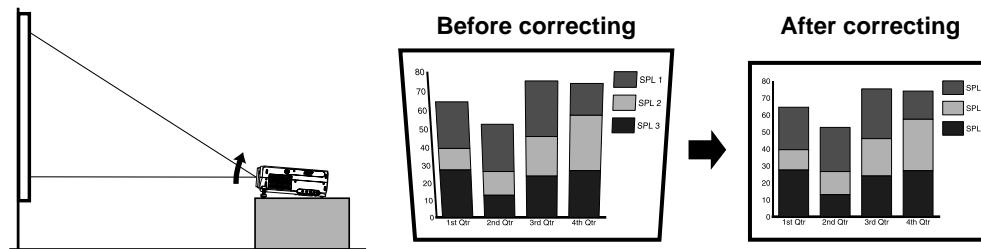

**AUTO
KEYSTONE**





KEYSTONE



Press AUTO KEYSTONE.

The keystone distortion on the picture projected is automatically corrected.

The icon  appears while the keystone correction is executing.

To correct further, make the “Keystone” adjustment on the menu.  

Notes

- Due to digital correction processing, some of the information may be dropped or the picture quality may be degraded depending on the keystone correction setting or the contents of the signal source.
- Keystone distortion is not corrected properly when the screen is not installed vertically. In this case, adjust from the menu screen.

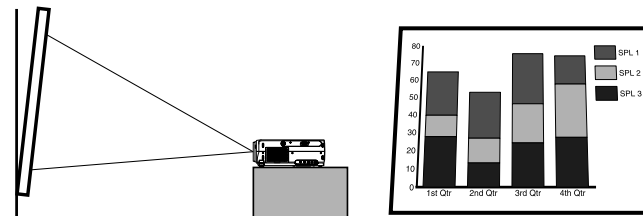

Even if the projector is set horizontal, keystone distortion may occur if the screen is at an angle. In this case automatic correction is impossible.

Enlarging the picture size

Remote control

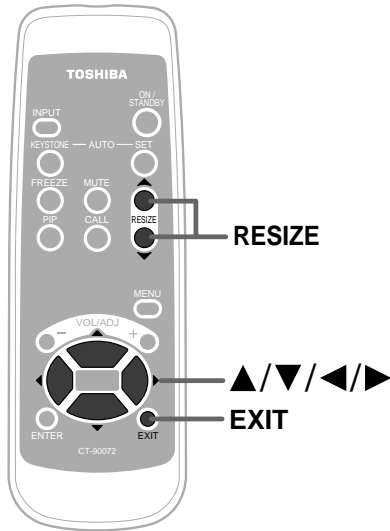

The icon  appears in the resize mode.

You can enlarge (resize) the picture size projected.



Press RESIZE (▲).

The enlargement ratio increases each time the **RESIZE (▲)** button is pressed.

The enlargement ratio can be increased continuously by keeping the button pressed in.

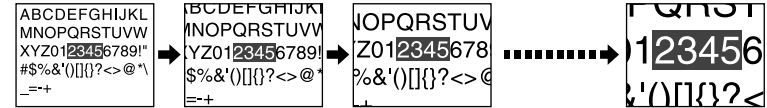

To reduce the enlargement ratio, press the **RESIZE (▼)** button.

The enlargement ratio can be reduced continuously by keeping the button pressed in.

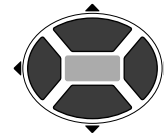
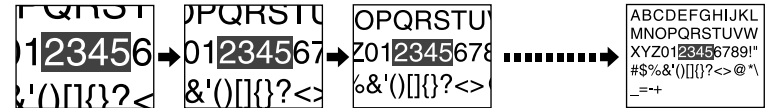

The enlarged section is moved when the selection buttons (▲/▼/◀/▶) are pressed.

The section can be moved continuously by keeping the button pressed in.

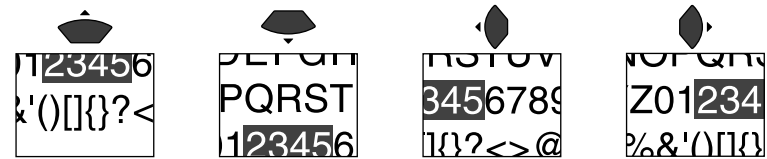

Press the **EXIT** button to cancel the resize mode and return to the original size.

Notes

- Enlarged images can be frozen by pressing the **FREEZE** button. When frozen, images cannot be enlarged or reduced.
- The resize mode is cancelled if any operation other than setting the freeze mode is performed.
- This projector uses electrical digital resizing, so the picture quality degrades when images are enlarged.
- In rare cases, the picture may be disturbed while the magnification section is being moved.
- With some signals, the image cannot be enlarged.
- This function does not work in no input status (no signal is supplied from the signal source).

Cutting off the picture and sound temporarily

Remote control

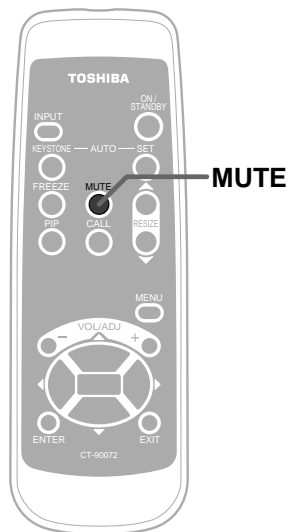

The image and sound of this projector can be turned off if you wish to temporarily project the image of another projector or a OHP, etc., on the screen.

MUTE



Press MUTE.

The sound and picture are cut off temporarily.

To cancel the mute mode, press **MUTE** again. The image and sound will be output.

The icon  appears in the mute mode.

Note

The mute mode is cancelled if another operation is performed during the mute mode.

Freezing the picture

Remote control

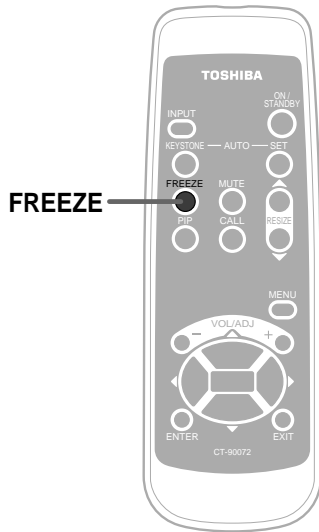

You can freeze the image being projected.

Use this function to stop images from a video recorder to make presentations.

FREEZE



Press **FREEZE**.

The picture freezes.

To release the picture, press **FREEZE** again.

The icon  appears in the freeze mode.

Notes

- The freeze mode is cancelled if any other operation is performed during the freeze mode.
- The freeze mode cannot be set when there is no input (when no signals are being supplied from a signal source).
- The input source's image continues to play even when the projector is set to the freeze mode.

Adjusting the picture automatically (Computer input)

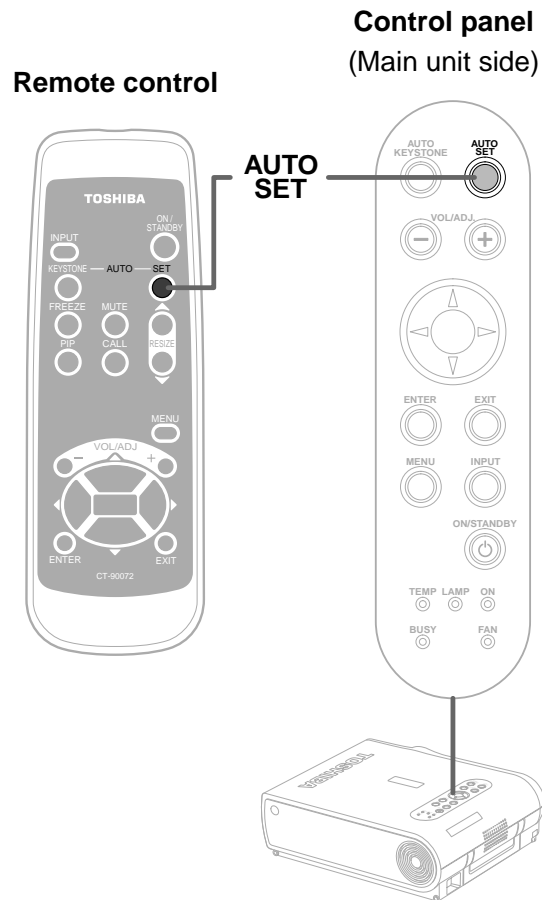

You can adjust the optimum horizontal position, vertical position, sampling phase and sampling frequency for projecting computer's signals at the touch of a button.

1

Input full screen video signals from the input source (computer) and project the image.

Adjustments may not be performed properly for images that are not displayed on the entire screen or extremely dark images.

2



Press AUTO SET.

The horizontal position, vertical position, sampling phase and sampling frequency are adjusted automatically.



The icon  appears during signal processing.

Notes

- Automatic adjustment may not be performed properly for signals other than the computer's signals with which the projector is compatible [73](#).
- The horizontal position, vertical position, sampling phase and sampling frequency can also be adjusted from the menu screen [44](#).

* Sampling frequency

Analog RGB signals input from the computer are converted into digital signals inside the projector. The sampling frequency is the number of times per second the analog signals are converted into digital signals. In order to capture (sample) each individual dot of the computer's signals, the sampling frequency must be adjusted to match the computer's dot clock frequency. If this adjustment is off, details of the image may be blurred, a striped pattern may appear when images with many vertical lines are displayed, or the image's width may change. For computer's signals with which the projector is compatible, the sampling frequency is adjusted automatically even without pressing the **AUTO SET** button.

* Sampling phase

The sampling phase is the timing at which the computer's analog RGB signals are sampled. If the sampling phase is off, the individual dots cannot be sampled at the proper timing, resulting in blurred or flickering images.

Displaying PIP Sub-pictures

Remote control

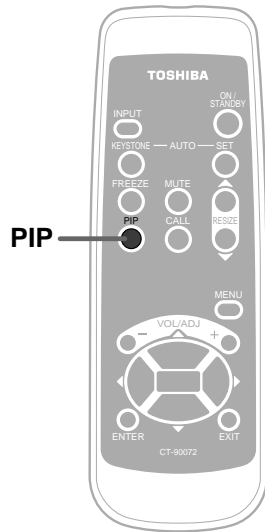

Video or S-video images can be displayed as small images on the computer's image. (Referred to as "sub-pictures" in this manual.)



Press PIP.

A sub-picture is displayed.

Press the **PIP** button again to turn off the sub-picture.

Notes

- The PIP function cannot be used when a source other than a computer input source is selected.
- The PIP function cannot be used with no signals supplied from a computer signal source.
- The sub-picture turns off if any other operation is performed.
- The signal source, size, display position and audio input source to display sub-pictures can be changed from the menu screen. [63](#)

Displaying Information

Remote control

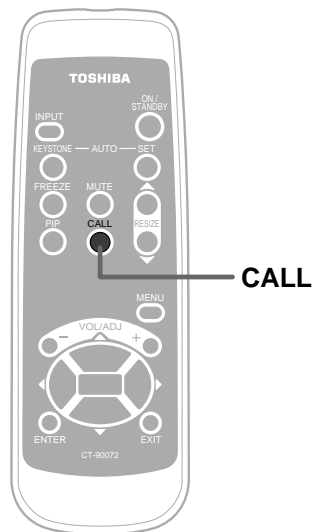

Information on the input signal source, etc., can be displayed.

CALL



Press CALL.

The information described below is displayed.

The information display turns off when the **CALL** button is pressed again.



Status display

Input	– current input source
H-resolution	– the horizontal resolution of the input signal (at Computer input)
V-resolution	– the vertical resolution of the input signal (at Computer input)
H-frequency	– the horizontal frequency of the input signal (at Computer input)
V-frequency	– the vertical frequency of the input signal (at Computer input)
Video mode	– the color mode of the video signal (at video, S-video input)
Signal format	– the formatting of the Y/P _B /P _R signal (at Y/P _B /P _R input)
Lamp time	– the elapsed using time of the lamp
Version	– the version of the firmware

Notes

- The information displayed is not refreshed even if it changes. To refresh the information, turn off the information display, then turn it back on.
- The information display turns off if any other operation is performed.
- The “Lamp time” shows an approximate time for lamp replacement. (It should not be used as a lamp warranty time counter.) If the time indicated here nears 1000, contact your store of purchase about obtaining a replacement lamp (TLPLX10, sold separately).
- The “Lamp time” can be reset when the lamp is replaced.
- The “Version” is the version of the control program used in the projector and is used for servicing, etc.

Adjustments and settings on the menu screen

QUICK MENU 38

Item	Meaning
Contrast	Adjust the image contrast
Brightness	Adjust the image brightness (paying attention to the dark parts)
Color	Adjust the image color (except for Computer inputs)
Phase	Adjust the image flicker (Computer input)
Picture mode	Computer input: Set brightness priority or picture quality (color) priority Except computer input: Standard/Movies/Sports
Keystone	Adjust keystone distortion
Input source setting	Set the input mode selected by the INPUT button
Language	Set the display language used for menus and messages

FULL MENU

Picture 44

Item	Meaning
Contrast	Adjust the image contrast
Brightness	Adjust the image brightness
Color	Adjust the image color
Tint	Adjust the image tint
Sharpness	Adjust the image sharpness
Phase	Adjust the image flicker (dot clock timing adjustment)
Frequency	Adjust the vertical stripes with detailed images (dot clock frequency adjustment)
Position	Adjust the horizontal and vertical positions of the image
Level	Adjust the red, green and blue level (balance)
Picture mode	Set brightness priority or picture quality (color) priority
Video mode	Set the Video or S-video color system
Signal format	Set the Y/P _B /P _R signal DTV format
Screen size	Set the mode of screen size

Audio 50 (Adjust the audio output from the speaker on the main unit)

Item	Meaning
Speaker output	Set the speaker output On/Off
Channel select (RCA)	Select the channel of AUDIO (L/R) jack in VIDEO IN
Loudness (RCA)	Set the loudness of AUDIO (L/R) jack On/Off in VIDEO IN
Channel select (Mini)	Select the channel of AUDIO IN jack
Loudness (Mini)	Set the loudness of the AUDIO IN jack On/Off

Keystone 52

Item	Meaning
Keystone	Adjust the Keystone distortion
Horizontal reference value reset	Reset the horizontal reference value for the automatic adjustment

Display 54

Item	Meaning
Language	Set the display language used for menus and messages
No signal background	Set the background at no signal input
Icon	Set the icon display On/Off
Menu position	Set the position of the menu screen
Menu background translucent	Set the menu background translucent On/Off
Start-up screen	Set the start-up screen at power on

Default setting 57

Item	Meaning
Input source setting	Set the input mode selected by the INPUT button
Projection mode	Set the direction of the screen according to the projection mode
No signal power off	Set the automatic power off function On/Off when no signal status continues
Power on	Set the power on On/Off when plugging the power cord

Factory reset mode 61

Item	Meaning
Picture only	Return the items of the picture menu to the factory default setting for each input source.
All	Return all of the items to the factory default setting for all input sources.

Note

An exclusive menu is displayed when making PIP function sub-picture settings. 63

Operating the menu screen

Start

Press the MENU button to display the QUICK MENU.

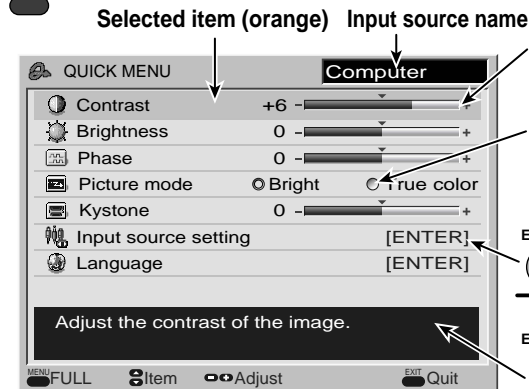

Adjustment display bar
Displayed for adjustable items

Setting display buttons
Displayed for items set by selection.
The setting displayed in yellow is the one currently set.

There are also items with sub-menus displayed by pressing the **ENTER** button. Some items in the FULL MENU have sub-menus.

In the QUICK MENU screen, simple explanations of the selected items are displayed.

The button operation guide is displayed here.

Sub-menu (example: input setting)

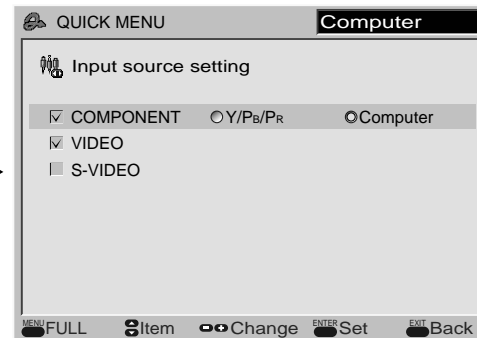

The sub-menus include items that are set by pressing the **ENTER** button. When a sub-menu is displayed, it will return to the previous menu by pressing the **EXIT** button.

The first menu displayed in the FULL MENU mode is the "Picture" menu.

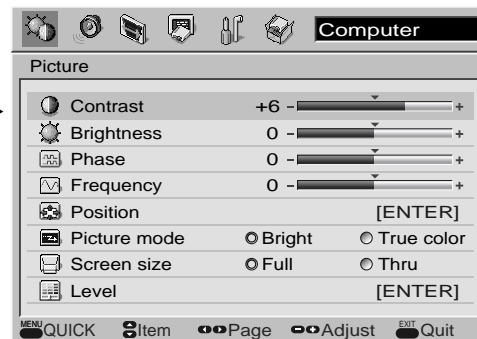

When the **MENU** button is pressed in the FULL MENU mode, the QUICK MENU reappears.

Each press of the selection buttons (◀/▶) change the menus as shown:
[Picture] ↔ [Audio] ↔ [Keystone] ↔ [Display]
↻ [Factory reset mode] ↔ [Default Settings] ↻

The contents of the operation guide differ according to the type of menu and the selected item.

The FULL MENU appears when the **MENU** button is pressed.

Use the selection buttons (▲/▼) to select the item to be adjusted or set.

Use the **VOL/ADJ** (+/-) buttons to adjust or set the selected items.

End
Press the **EXIT** button to end the adjustments and settings and turn the menu off.

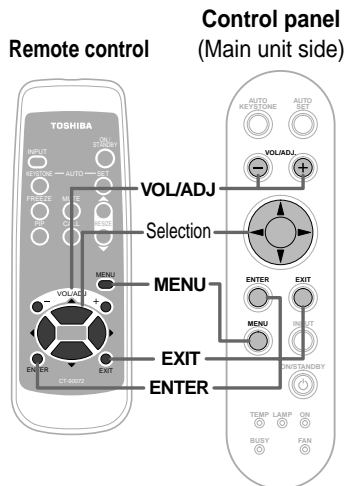

Adjustments and settings that have been made here are automatically stored in the memory when the power is turned off by the **ON/STANDBY** button.

QUICK MENU adjustments and settings

You can set the basic setting used frequently.

Remote control



Control panel
(Main unit side)

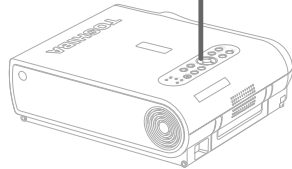
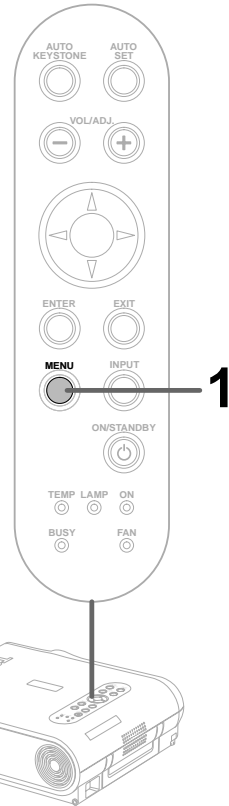

Preparation

1 Project a picture on the screen as explained in the step "Projection on the screen". 25

1

MENU



MENU



Press MENU.

The QUICK MENU appears.

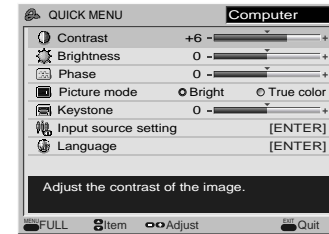

- To cancel the QUICK MENU screen, press the **EXIT** button.
- The contents of the menu are different depending on the type of input source currently selected.

QUICK MENU adjustments and settings (continued)

Remote control



Control panel
(Main unit side)

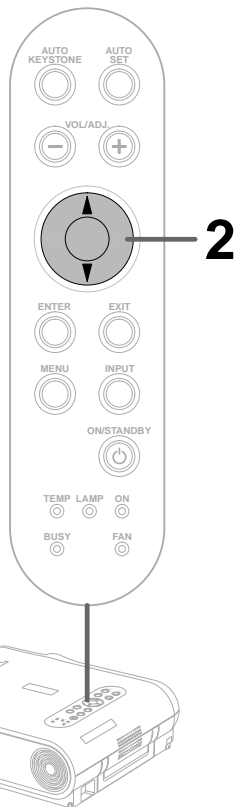

2

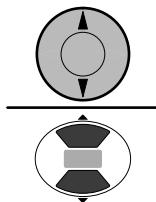

Use the selection buttons (▲ / ▼) to select the adjustment and setting items.

The types of adjustment and setting items are different depending on the type of input source currently selected.
(See the table below.)

Adjustments		Yes: Adjustable No: Not displayed			
Items	Inputs	Computer	Y/Pb/Pr	Video	S-Video
Contrast		Yes	Yes	Yes	Yes
Brightness		Yes	Yes	Yes	Yes
Color		No	Yes	Yes	Yes
Phase		Yes	No	No	No
Keystone		Yes(same for all of the inputs)			

Settings		Yes: Settable			
Items	Inputs	Computer	Y/Pb/Pr	Video	S-Video
Picture mode		Yes	Yes	Yes	Yes
Input source setting		Yes(same for all of the inputs)			
Language		Yes(same for all of the inputs)			

Note

The “Keystone” adjustment and the “Input source setting” and “Language” settings are applied to all the input sources.

QUICK MENU adjustments and settings (continued)

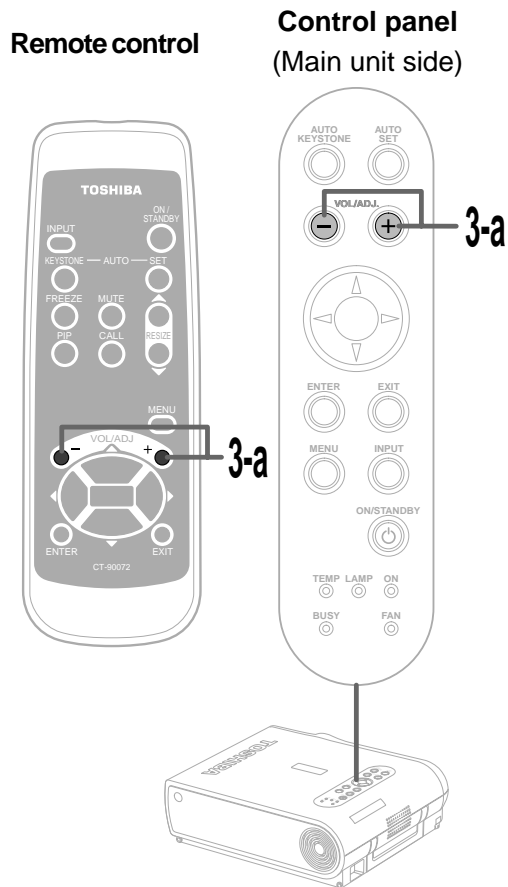

When selecting “Contrast”, “Brightness”, “Color”, “Phase”, “Keystone”, “Picture mode”, in step 2.

3-a

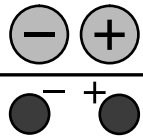

Press VOL/ADJ (+/-) to adjust and set.

Adjustments

Items	Inputs	(-)	(+)
Contrast		Lower	Higher
Brightness		Darker	Brighter
Color		Thinner	Deeper
Phase		Adjust flickers	Adjust flickers
Keystone		Reduce the lower width	Reduce the upper width

Settings

Picture mode (Except computer input)

STANDARD : Standard

 : Fit for movies

 : Fit for sports

Picture mode (Computer input)

Bright: Set the picture with its brightness priority.

True color: Set the picture with its quality (color) priority.

QUICK MENU adjustments and settings (continued)

Remote control

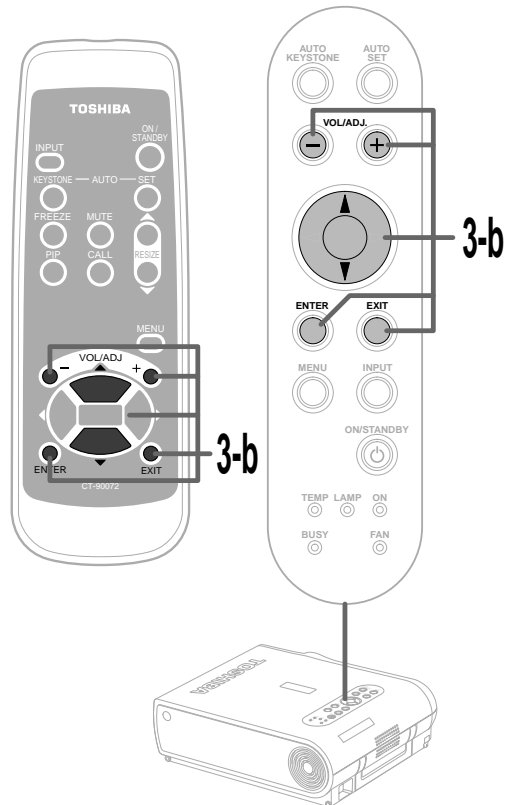
Control panel
(Main unit side)

When selecting "Input source setting" in step 2. (Set the input source that can be selected by the **INPUT** button.)

3-b

ENTER



ENTER



Press ENTER.

The sub-menu screen of input source setting appears.

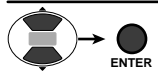
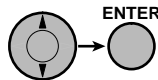
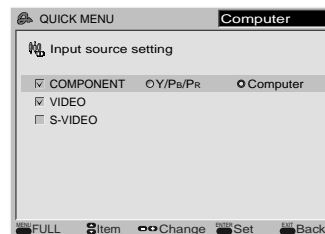

Use the selection buttons (**▲ / ▼**) to select the input source to be set, then press **ENTER** to check it.

- The check turns on and off each time the **ENTER** button is pressed.
- When a check box is checked, that input source can be selected by the **INPUT** button.

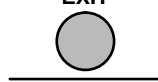
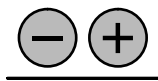

(When selecting **COMPONENT**)

Press **VOL/ADJ (+/-)** to select the type of input source.

The setting whose button is displayed in yellow is the one currently selected.

Press **EXIT** to return to the QUICK MENU.

Notes

- It is impossible to exit from the menu if no input source is selected.
- If the check in the check box for the currently selected source is removed, the setting becomes effective the next time the input is changed.

QUICK MENU adjustments and settings (continued)

Remote control

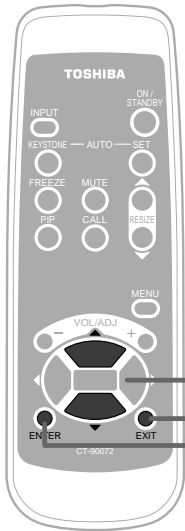
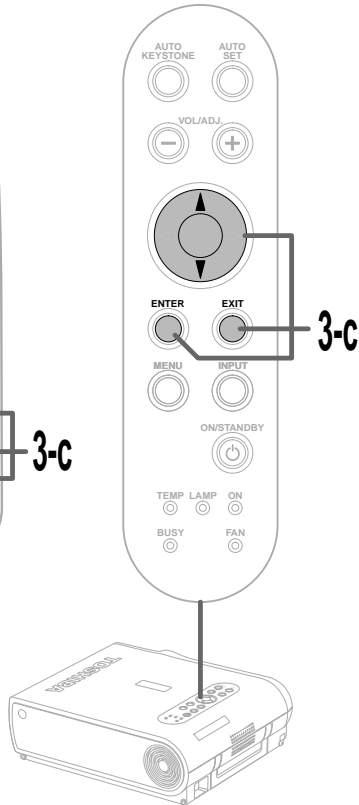
Control panel
(Main unit side)

When selecting "Language" in step 2. (Set the language used in the menu display.)

3-c

ENTER



ENTER



Press ENTER.

The sub-menu screen of language setting appears.

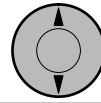

Use the selection buttons (▲ / ▼) to select a language.

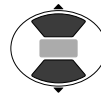

English	: English
Français	: French
Deutsch	: German
Italiano	: Italian
Español	: Spanish
Português	: Portuguese
日本語	: Japanese
简体字	: Chinese (Simplified)
繁體字	: Chinese (Traditional)
한국어	: Korean

EXIT



EXIT

Press EXIT to return to the QUICK MENU.

QUICK MENU adjustments and settings (continued)

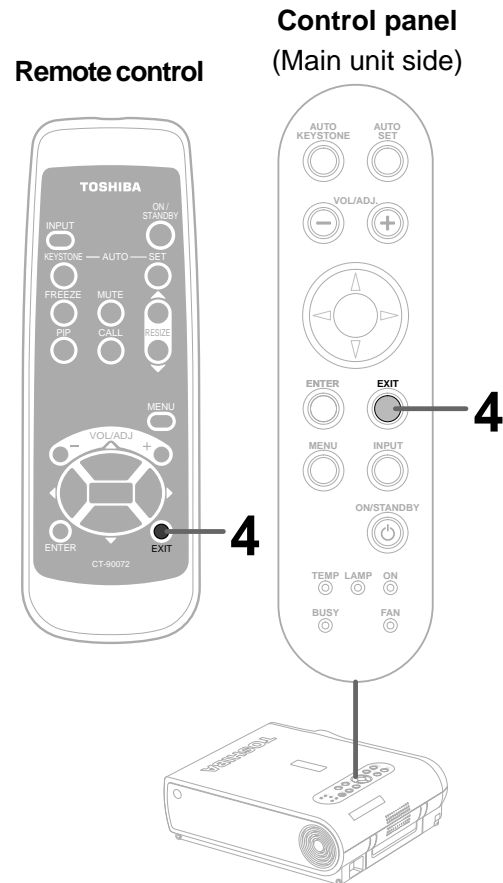

4

EXIT

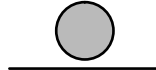

EXIT

After the adjustments and settings are finished, press **EXIT**.

The menu screen disappears.

Note

If the power is turned off by pressing the **ON/STANDBY** button, the adjustments or settings made are automatically stored in the memory. If the power cord is unplugged or if a power failure occurs while the projector is on, the adjustments or settings are not stored in the memory.

FULL MENU adjustments and settings – Picture

You can adjust contrast, brightness, color level, image position, etc.

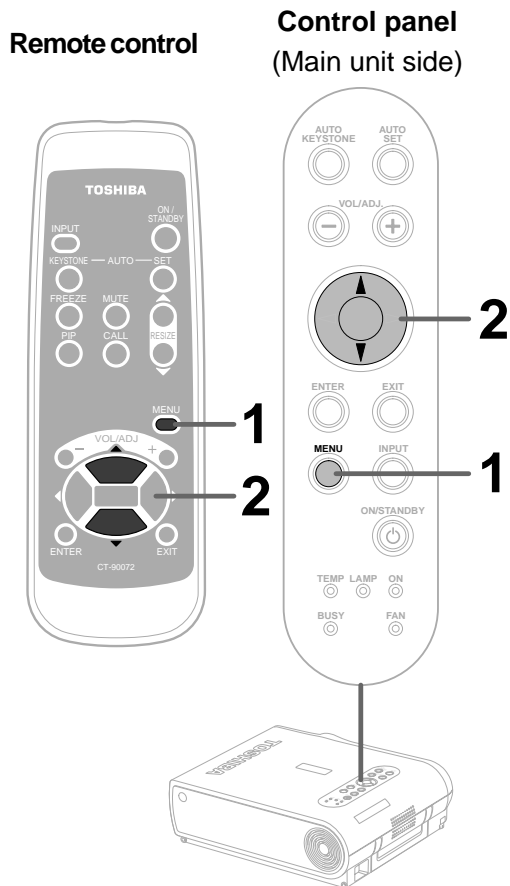

Preparation

1 Project a picture on the screen as explained in the step “Projection on the screen”. 25

1

MENU



MENU



Press MENU twice.

When pressed once, the QUICK MENU screen appears. When pressed twice, the “Picture” screen of the FULL MENU appears.

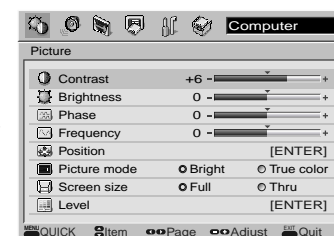
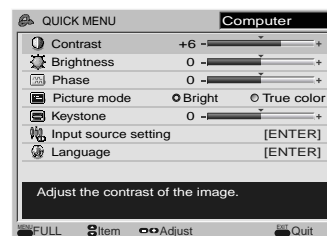

2

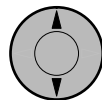

Use the selection buttons (▲ / ▼) to select the adjustment and setting items.

The types of adjustment and setting items are different depending on the type of input source currently selected. (See the table below.)

Adjustments		Yes: Adjustable No: Not displayed			
Items	Inputs	Computer	Y/Pb/Pr	Video	S-Video
Contrast		Yes	Yes	Yes	Yes
Brightness		Yes	Yes	Yes	Yes
Color		No	Yes	Yes	Yes
Tint		No	Yes ^{*1}	Yes ^{*2}	Yes ^{*2}
Sharpness		No	Yes ^{*1}	Yes	Yes
Phase		Yes	No	No	No
Frequency		Yes	No	No	No
Position		Yes	No	No	No
Level		Yes	Yes	Yes	Yes

*1: Adjustment is impossible at 480i mode.

*2: Adjustment is impossible at PAL/SECAM.

Continued

FULL MENU adjustments and settings picture (Continued)

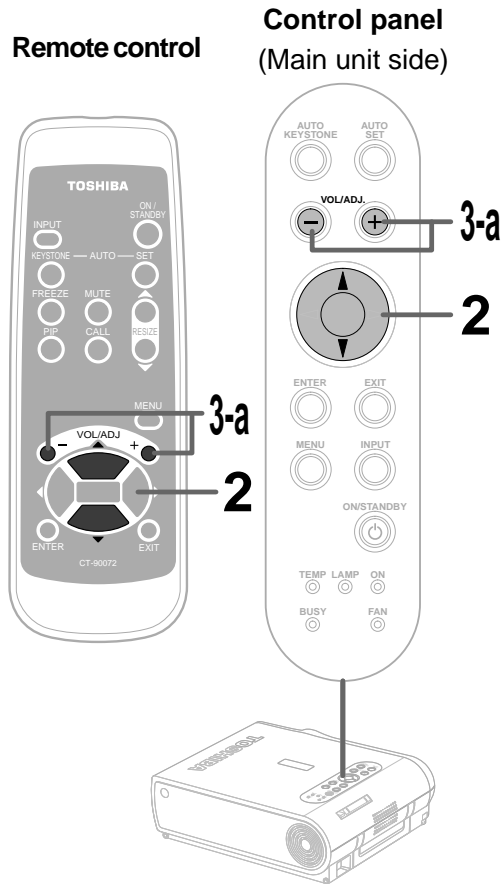

2
(Continued)

Settings		Yes: Settable No: Not displayed			
Items	Inputs	Computer	Y/Pb/Pr	Video	S-Video
Picture mode		Yes	No	No	No
Screen size		Yes	Yes	Yes	Yes
Signal format		No	Yes	No	No
Video mode		No	No	Yes	Yes

When selecting "Contrast", "Brightness", "Color", "Tint", "Sharpness", "Phase", "Frequency", "Picture mode", "Screen size" in step 2.

3-a

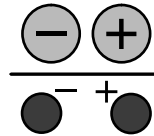

Press VOL/ADJ (+/-) to adjust and set.

Adjustments			
Items	Inputs	(-)	(+)
Contrast		Lower	Higher
Brightness		Darker	Brighter
Color		Thinner	Deeper
Tint		Redder	Greener
Sharpness		Softer	Sharper
Phase		Adjust flickers	Adjust flickers
Frequency		Adjust vertical stripes	Adjust vertical stripes

Settings

Picture mode (Computer input)

Bright: Set the picture with its brightness priority.

True color: Set the picture with its quality (color) priority.

FULL MENU adjustments and settings – Picture (continued)

When selecting "Position" or "Level" in step 2.

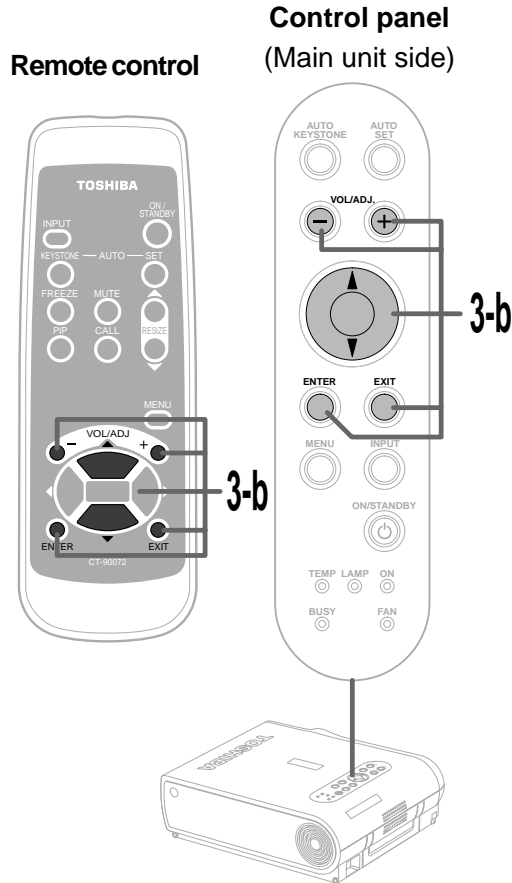

3-b

ENTER



Press ENTER.

The sub-menu of selected items appears.

ENTER

"Position"

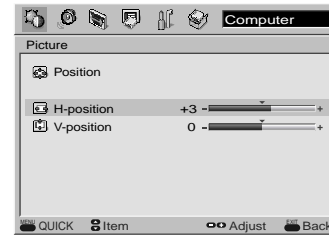

"Level"

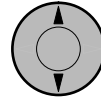
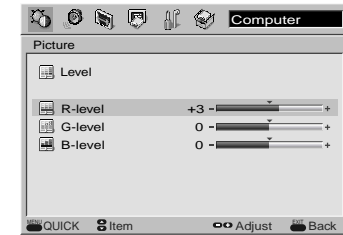

Use the selection buttons (▲ / ▼) to select adjustment items.

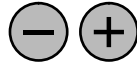

Press VOL/ADJ (+/-) to adjust.

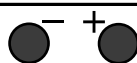

Items	Inputs	Adjustments	
		(-)	(+)
Position	H-position	Move the picture leftward	Move the picture rightward
	V-position	Move the picture down	Move the picture upward
Level	R-level	To reduce red	To increase red
	G-level	To reduce green	To increase green
	B-level	To reduce blue	To increase blue

EXIT



Press EXIT to return to the FULL MENU.

EXIT

FULL MENU adjustments and settings – Picture (continued)

Remote control

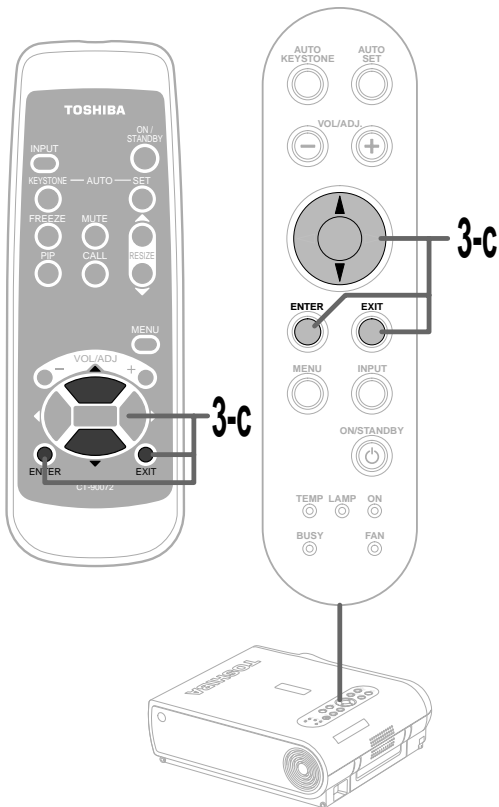
Control panel
(Main unit side)

When selecting “Signal format”, “Video mode” or “Interval” in step 2.

3-C

ENTER



Press ENTER.

The sub-menu of selected items appears.

ENTER

“Signal format”

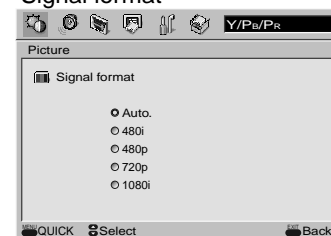

“Video mode”

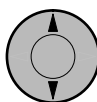
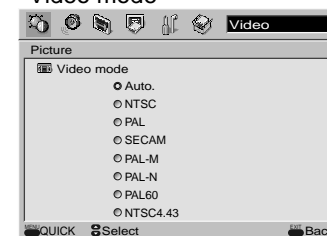

Use the selection buttons (▲ / ▼) to select setting items.



Signal format (Y/PB/PR input)

Auto: Determine the type of the signal input automatically.
If not determined properly, select among the signals shown below.
480i, 480p, 720p, 1080i

Video mode (Video input, S-Video input)

Auto: Determine the type of the signal input automatically.
If not determined properly, select among the signals shown below.
NTSC, PAL, SECAM, PAL-M, PAL-N, PAL60, NTSC4.43

EXIT



EXIT

Press Exit to return to the FULL MENU

FULL MENU adjustments and settings – Picture (continued)

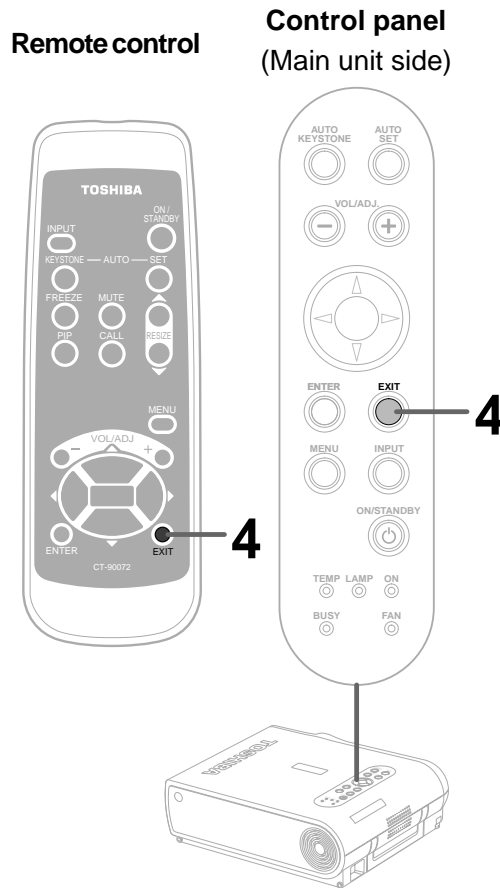

4

EXIT

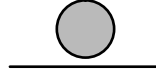

EXIT

After the adjustments and settings are finished, press EXIT.

The menu screen disappears.

Note

If the power is turned off by pressing the **ON/STANDBY** button, the adjustments or settings made are automatically stored in the memory. If the power cord is unplugged or if a power failure occurs while the projector is on, the adjustments or settings are not stored in the memory.

FULL MENU settings – Audio

You can set the audio signals developed from the speaker. (The speaker output is monaural.)

Remote control

Control panel
(Main unit side)

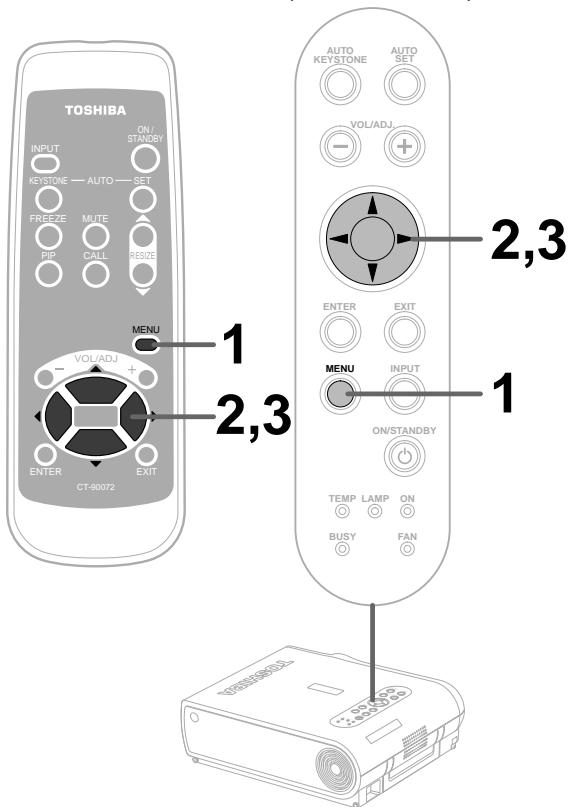

Preparation

1 Project a picture on the screen as explained in the step “Projection on the screen”. 25

1

MENU



MENU



Press MENU twice.

When pressed once, the QUICK MENU screen appears. When pressed twice, the “Picture” screen of the FULL MENU appears.

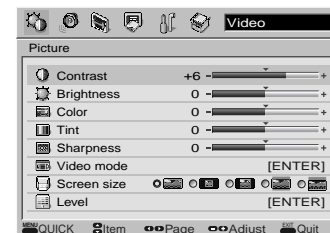
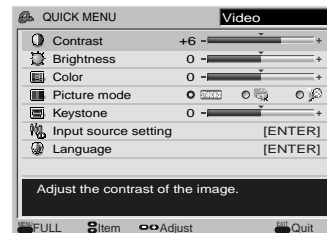

2

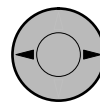

Use the selection button (▶) to display the “Audio” menu.

If you pass by the “Audio” menu, press the selection button (◀) to move back to it.

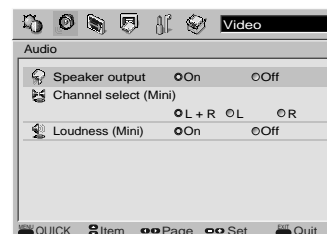

3

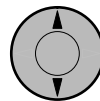

Use the selection buttons (▲ / ▼) to select the setting items.

(RCA): Audio input jack (R-AUDIO-L) of VIDEO IN
(Mini): AUDIO IN jack

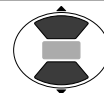

FULL MENU settings – Audio (continued)

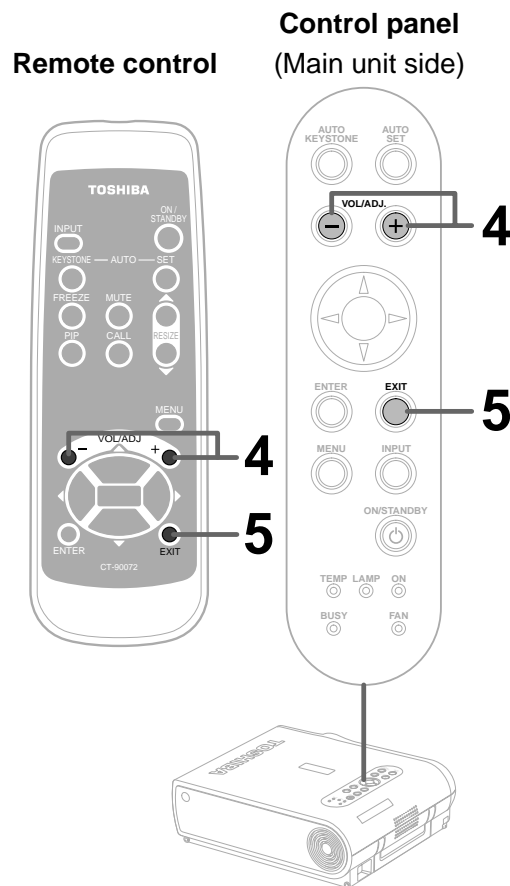

4

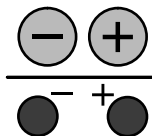

Press **VOL/ADJ (+/-)** to adjust and set.

Speaker output

When set to "Off", no sound is produced from the speakers.

Channel select

L+R: The sound of the left and right channels is mixed and developed from the speakers.

L: To develop only left input audio signal from the speakers.

R: To develop only right input audio signal from the speakers.

Loudness

When set to "On", the loudness effect is added to the speaker sound.

5

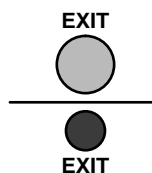

After the settings are finished, press **EXIT**.

The menu screen disappears.

Notes

- If the power is turned off by pressing the **ON/STANDBY** button, the settings made are automatically stored in the memory. If the power cord is unplugged or if a power failure occurs while the projector is on, the settings are not stored in the memory.
- The "Audio" settings are applied to all the input sources. (It is impossible to change the settings for each input source.)

FULL MENU settings – Keystone

- If the screen is not installed vertically, you can adjust the keystone distortion manually.
- The projector stores the standard conditions of horizontal installation, but depending on the usage environment (if the projector is subject to vibrations or shock, etc.), the standard may change. If the keystone distortion is not properly corrected when the **AUTO KEYSTONE** button is pressed with the screen installed vertically, set the projector on a flat surface then use the menu screen's "Horizontal reference value reset" function.

Remote control

Control panel (Main unit side)

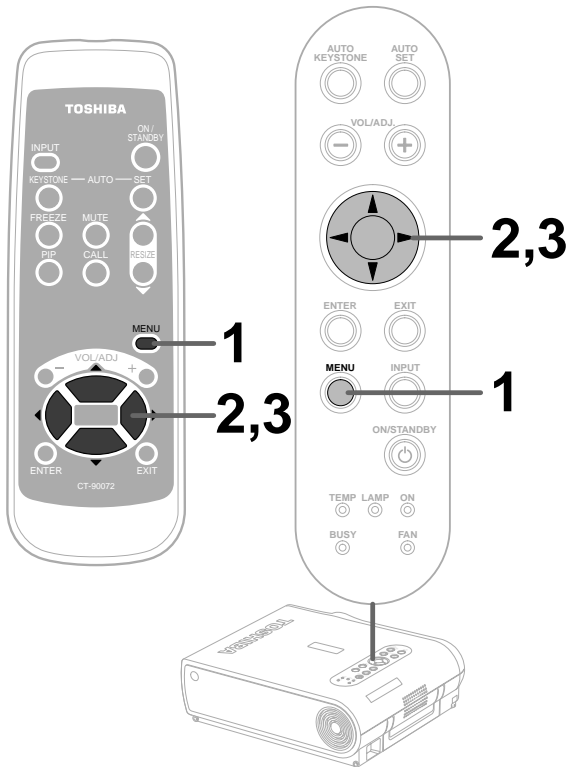

Preparation

- 1 Project a picture on the screen as explained in the step "Projection on the screen". 25

1

MENU



MENU



Press MENU twice.

When pressed once, the QUICK MENU screen appears. When pressed twice, the "Picture" screen of the FULL MENU appears.

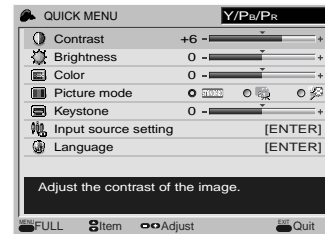

2



Use the selection buttons (◀/▶) to display the "Keystone" menu.

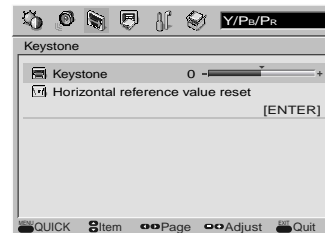

3



Use the selection buttons (▲/▼) to select the setting items.

FULL MENU settings – Keystone (continued)

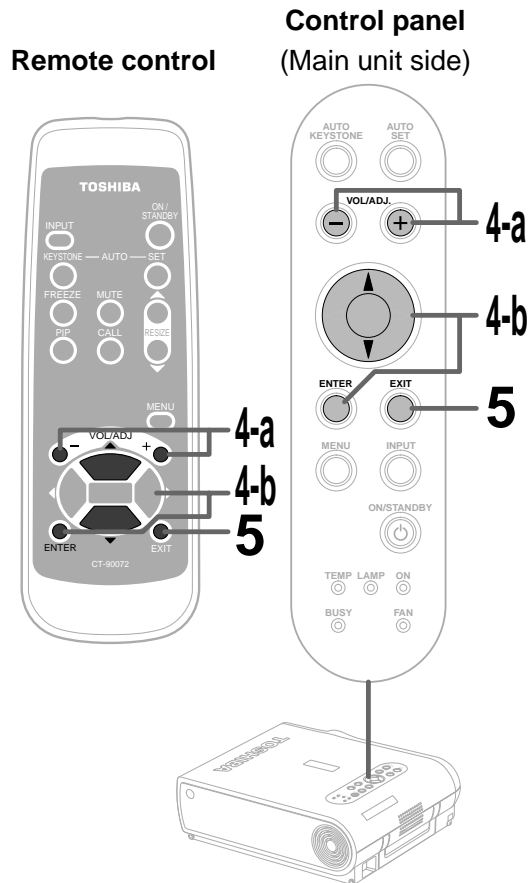

When selecting “Keystone” in step 3.

4-a

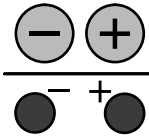

Press VOL/ADJ (+/-) to adjust and set.

(-)

(+)

Keystone: To reduce the lower width To reduce the upper width

When selecting “Horizontal reference value reset” in step 3.

4-b

ENTER



Press ENTER.

The sub-menu of “Horizontal reference value reset” appears.

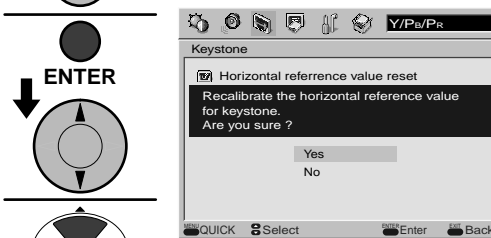

ENTER



Use the selection buttons (▲ / ▼) to select “Yes” and press ENTER.

The horizontal reference value is reseted.

ENTER



5

EXIT



After the adjustments and settings are finished, press EXIT several times until the menu screen disappears.

Press the EXIT button once when the FULL MENU is displayed, press twice when the sub menu is displayed.

Notes

- If the power is turned off by pressing the **ON/STANDBY** button, the adjustments or settings made are automatically stored in the memory. If the power cord is unplugged or if a power failure occurs while the projector is on, the adjustments or settings are not stored in the memory.
- The “Keystone” adjustments and settings are applied to all the input sources. (It is impossible to store different adjustments and settings for each input source.)

FULL MENU settings – Display

You can set the language, menu display and start-up screen, etc.

Remote control

Control panel
(Main unit side)

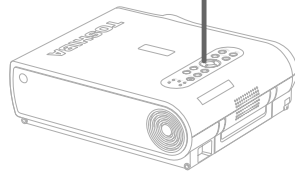
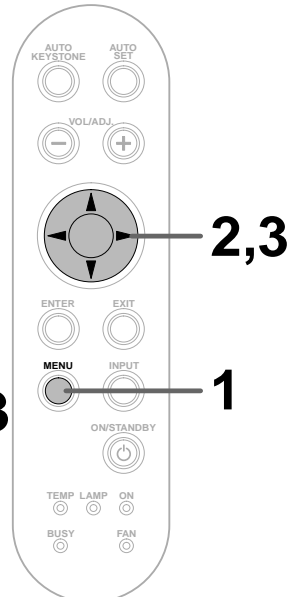
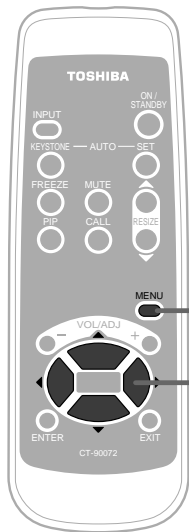

Preparation

1 Project a picture on the screen as explained in the step “Projection on the screen”. 25

1

MENU



MENU



Press MENU twice.

When pressed once, the QUICK MENU screen appears. When pressed twice, the “Picture” screen of the FULL MENU appears.

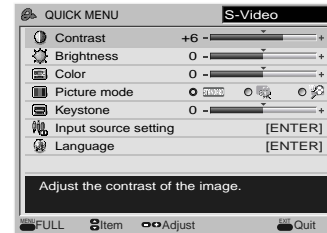

2

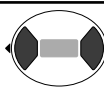
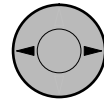

Use the selection buttons (◀/▶) to display the “Display” menu.



3

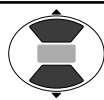
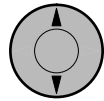

Use the selection buttons (▲/▼) to select the setting items.

FULL MENU settings – Display (continued)

Remote control



Control panel
(Main unit side)

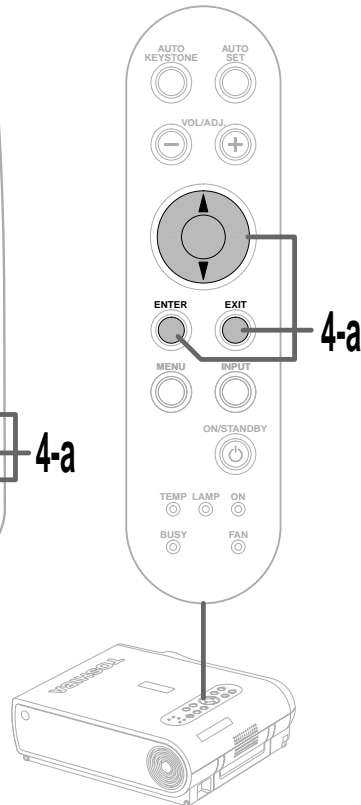

When selecting “Language” in step 3.

4-a

ENTER



Press ENTER.

The sub-menu of “Language” appears.



ENTER

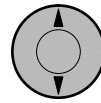

Use the selection buttons (▲ / ▼) to select a language.

English	: English
Français	: French
Deutsch	: German
Italiano	: Italian
Español	: Spanish
Português	: Portuguese
日本語	: Japanese
简体字	: Chinese (Simplified)
繁體字	: Chinese (Traditional)
한국어	: Korean



EXIT



Press EXIT to return to the FULL MENU.

EXIT

FULL MENU settings – Display (continued)

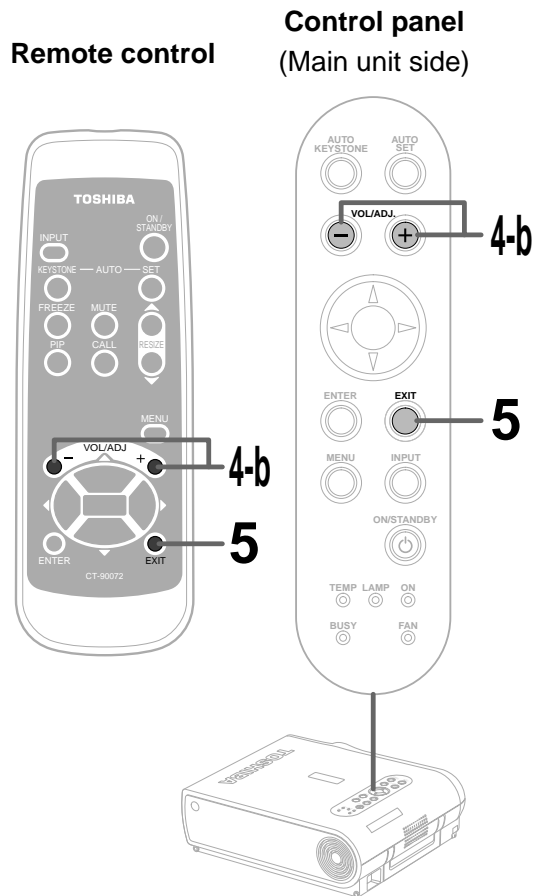

When selecting setting items other than “Language” in step 3.

4-b

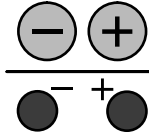

Press VOL/ADJ (+/-) to adjust and set.

No signal background (Setting of screen of no signal input)

Logo: The TOSHIBA logo screen is displayed.
 Blue background: The entire screen is blue.
 None: The screen is black.

Icon

When set to “Off”, the icons displayed normally when the input is changed or other operations are performed, are no longer displayed.

Menu position

Select the position where the menu is displayed (“Upper left”, “Upper right”, “Bottom left” or “Bottom right”).

Menu background translucent

When set to “On”, the menu background becomes translucent.

Start-up screen

When set to “On”, the opening screen is displayed when the power is turned on.

5

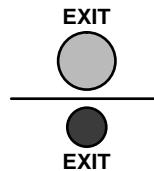

After the settings are finished, press EXIT.

The menu screen disappears.

Notes

- If the power is turned off by pressing the **ON/STANDBY** button, the settings made are automatically stored in the memory. If the power cord is unplugged or if a power failure occurs while the projector is on, the settings are not stored in the memory.
- The “Display” settings are applied to all the input sources. (It is impossible to store different settings for each input source.)

FULL MENU settings – Default setting

You can set the input source which can be selected by the **INPUT** button; you can also set the projection mode, power off at no signal status, power on mode and lamp power.

Remote control

Control panel (Main unit side)

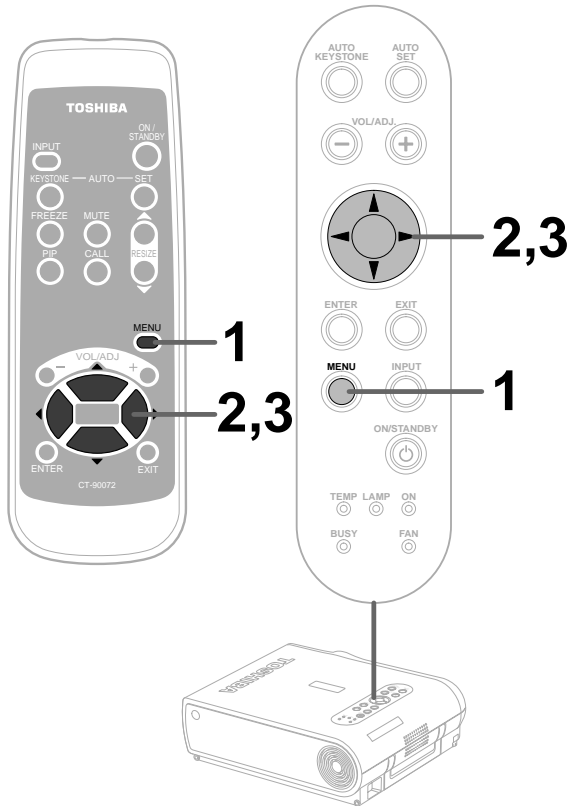

Preparation

1 Project a picture on the screen as explained in the step “Projection on the screen”. 25

1

MENU



MENU



Press MENU twice.

When pressed once, the QUICK MENU screen appears. When pressed twice, the “Picture” screen of the FULL MENU appears.

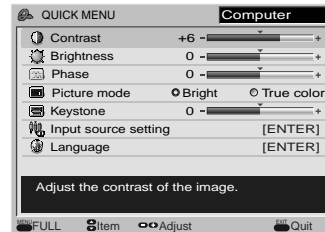

2

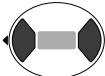
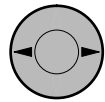

Use the selection buttons (◀/▶) to display the “Default setting” menu.

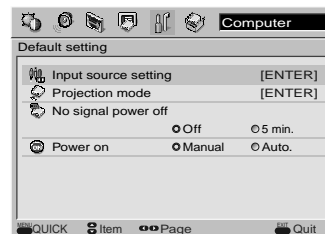

3

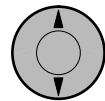

Use the selection buttons (▲/▼) to select the setting items.

FULL MENU settings – Default setting (continued)

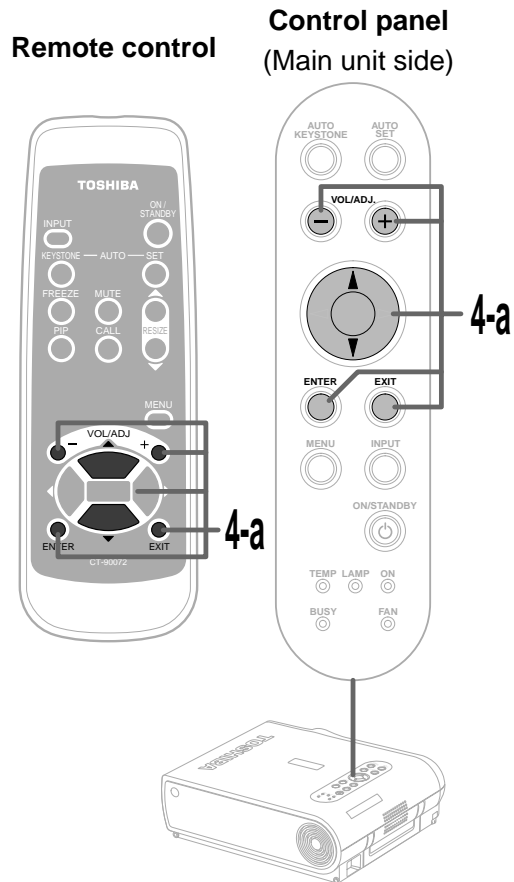

When selecting “Input source setting” in step 3. (Set the input that can be selected using **INPUT** button.)

4-a

ENTER



ENTER

Press ENTER.

The sub-menu of “Input source setting” appears.

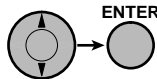
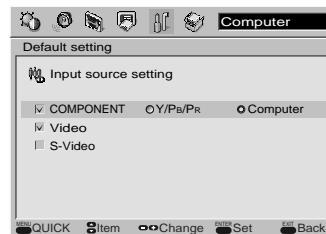

ENTER

Use the selection buttons (▲ / ▼) to select the input source to be set, then press ENTER to check it.

- The check turns on and off each time the **ENTER** button is pressed.
- When a check box is checked, that input source can be selected by the **INPUT** button.

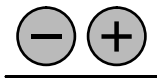

(When selecting **COMPONENT**)

Press VOL/ADJ (+/-) to select the type of input source.

The setting whose button is displayed in yellow is the one currently set.



EXIT

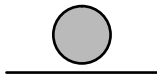

EXIT



EXIT

Press EXIT to return to the FULL MENU.

Notes

- It is impossible to exit from the menu if no input source is selected.
- If the check in the check box for the currently selected source is removed, the setting becomes effective the next time the input is changed.

Continued

FULL MENU settings – Default setting (continued)

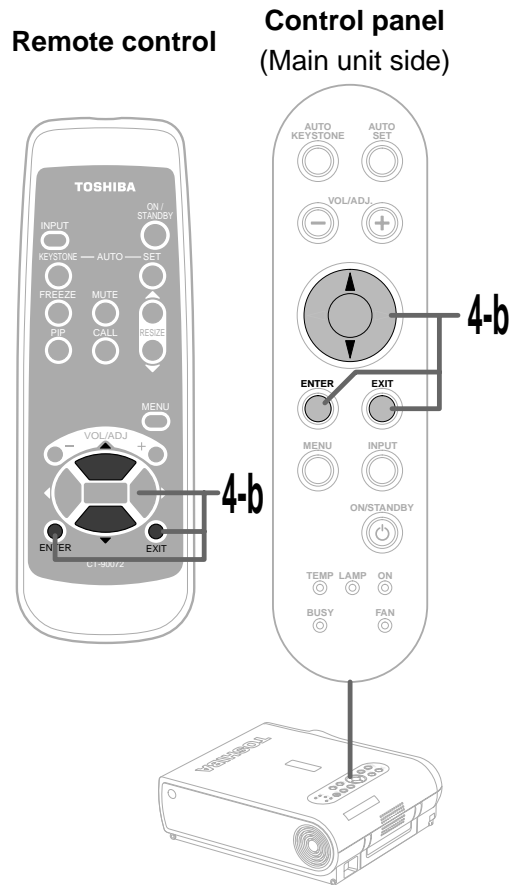

When selecting “Projection mode” in step 3.

4-b

ENTER



Press ENTER.

The sub-menu of “Projection mode” appears.

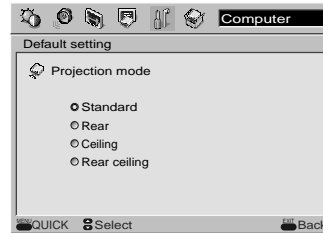

Use the selection buttons (▲ / ▼) to select the projection mode.

Select the installation position of the projector. Confirm by referring to the chart on page **16** , **20** .



- Standard: Floor-mounted front projection
- Rear: Floor-mounted rear projection
- Ceiling: Ceiling-mounted front projection
- Rear ceiling: Ceiling-mounted rear projection

EXIT



Press EXIT to return to the FULL MENU.

EXIT

FULL MENU settings – Default setting (continued)

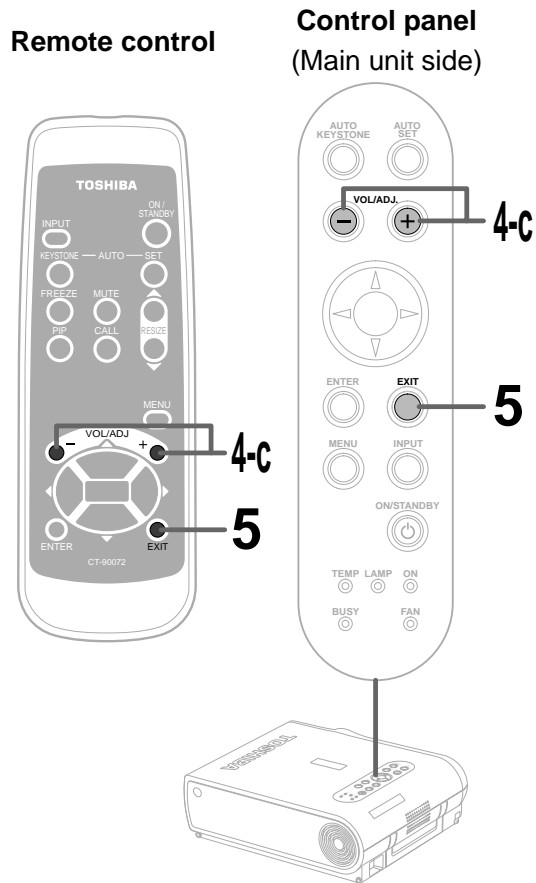

When selecting “No signal power off” or “Power on” in step 3.

4-c  **Press VOL/ADJ (+/-) to set.**

No signal power off

OFF: The power does not turn off automatically even if the no signal status continues.

5 min.: The power turns off automatically if the no signal status continues for approx. 5 min.

Power on

Manual: The power turns on by pressing the **ON/STANDBY** button.

Auto: When the power cord is plugged, the power turns on. (However, press the **ON/STANDBY** button when turns power off.)

5

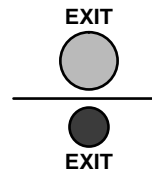

After the settings are finished, press EXIT.

The menu screen disappears.

Notes

- If the power is turned off by pressing the **ON/STANDBY** button, the settings made are automatically stored in the memory. If the power cord is unplugged or if a power failure occurs while the projector is on, the settings are not stored in the memory.
- The settings of “Default setting” are applied to all the input sources. (It is impossible to store different settings for each input source.)

FULL MENU settings – Factory reset mode

You can return the adjusting or setting value to the factory default setting.

Remote control

Control panel
(Main unit side)

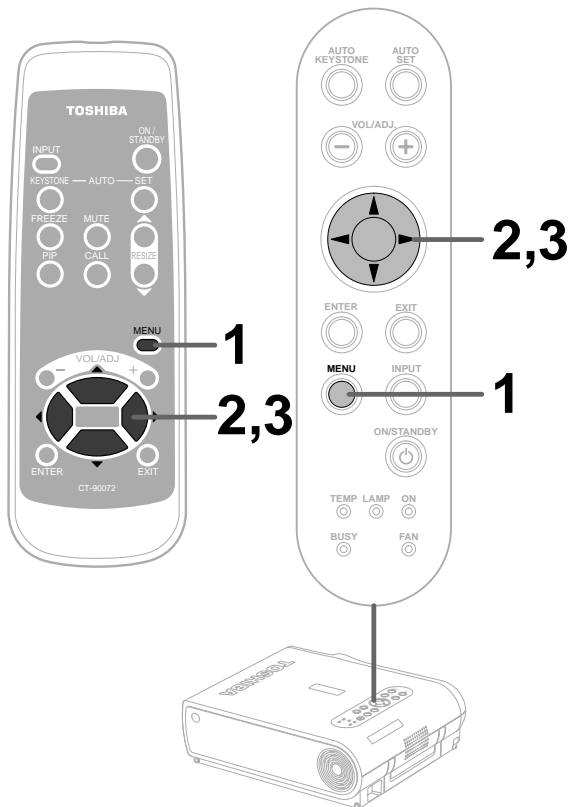

Preparation

1 Project a picture on the screen as explained in the step "Projection on the screen". 25

1

MENU



MENU



Press MENU twice.

When pressed once, the QUICK MENU screen appears. When pressed twice, the "Picture" screen of the FULL MENU appears.

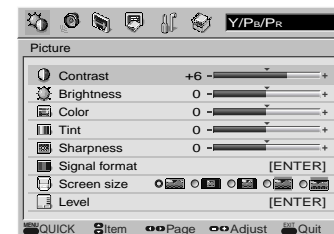
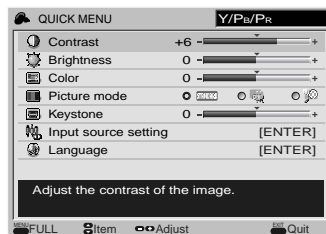

2

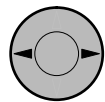

Use the selection buttons (◀/▶) to display the "Factory reset mode" menu.

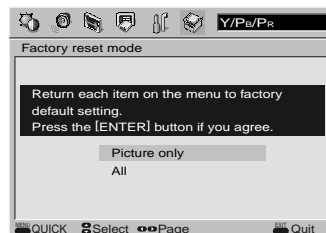

3

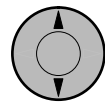

Use the selection buttons (▲/▼) to select the setting items.

Picture only: Reset only the adjustments and settings made on the "Picture" menus for the each input to the factory default setting.

All: Reset all the adjustments and settings for all the inputs to the factory default setting.

Continued

FULL MENU settings – Factory reset mode (continued)

Remote control
Control panel
(Main unit side)

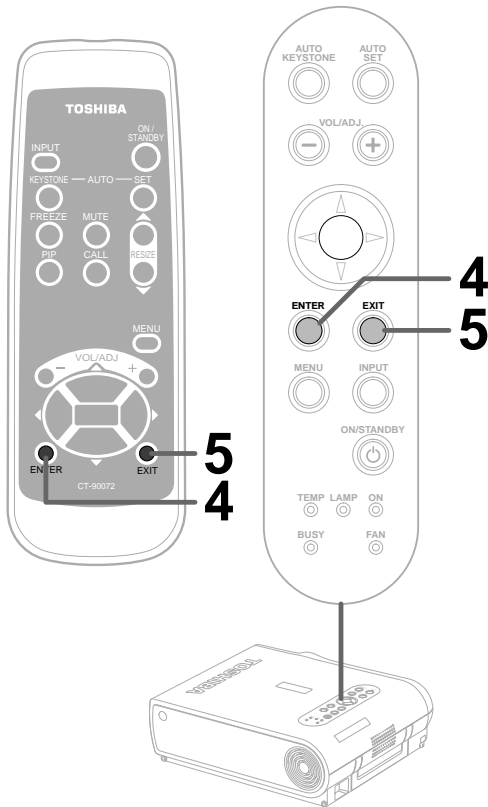

4

ENTER

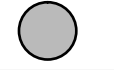

ENTER

Press ENTER.

The settings are reset to the factory default settings according to the conditions selected in step 3.

5

EXIT



EXIT

After the settings are finished, press EXIT.

The menu screen disappears.

Notes

- If the power is turned off by pressing the **ON/STANDBY** button, the setting made is automatically stored in the memory. If the power cord is unplugged or if a power failure occurs while the projector is on, the setting is not stored in the memory.
- When the "Factory reset mode" menu is executed, the adjustments and settings for all the inputs return to the factory default settings. (It is impossible to reset them for each input source.)

PIP menu setting

You can make the PIP sub-picture settings and the sound settings when a PIP sub-picture is displayed.

Remote control

Control panel
(Main unit side)

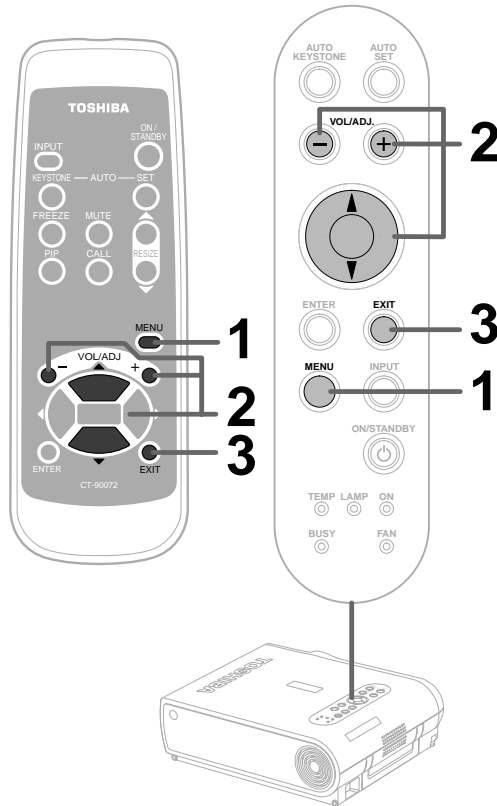

Preparation

1 Display the PIP sub-picture on the screen as explained in the step "Displaying PIP Sub-pictures". 34

1

MENU



MENU



Press MENU.

When a PIP sub-picture is displayed, the PIP menu screen appears.



2



Use the selection buttons (▲ / ▼) to select the setting items, then press VOL/ADJ (+/-) to set.

Source: Set the PIP sub-picture input source.

"Video input" or "S-video input" can be selected.

Size: Set the PIP sub-picture size.

"Small" or "Large"

Position: Set the display position of the PIP sub-picture.

"Upper left", "Upper right", "Lower left" or "Lower right"

Audio: Set the audio input source.

The sound of the selected picture ("Main picture" or "Sub-picture") is output from the speakers and the AUDIO OUT jack.

3

EXIT



EXIT



After the settings are finished, press EXIT.

The menu screen disappears.

Notes

- When the PIP sub-picture is turned off, the audio input source returns to the previous source (main picture).
- If the power is turned off by pressing the **ON/STANDBY** button, the settings made are automatically stored in the memory. If the power cord is unplugged or if a power failure occurs while the projector is on, the settings are not stored in the memory.

Trouble indications

If there is some problem inside the projector, the indicators light up or blink.

Control panel
(Main unit side)

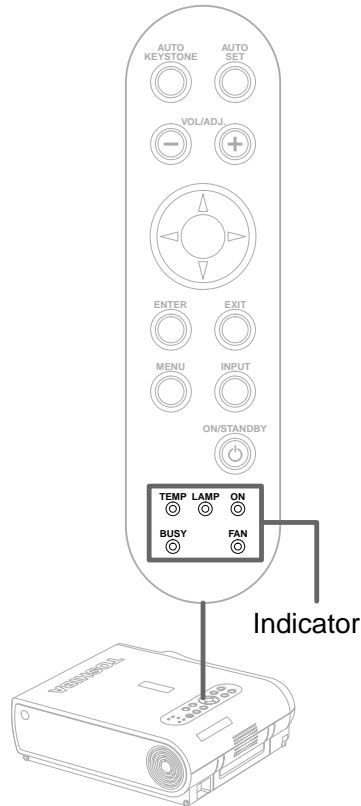

Indicator

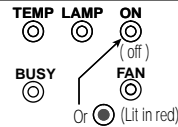

The power does not come on.

- Malfunction of the unit.
- Unplug the power cord and call the dealer.

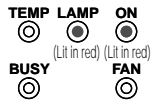

The lamp turns off or does not light up.

- The projector will return to the standby mode in about 2 minutes. If the projector does not operate normally when the power is switched on again, the lamp is at the end of its duration life or the unit has a fault.
- Lamp's duration life is over, replace the lamp with a new one. **68**
- Unplug the power cord and call the dealer.

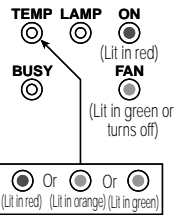

The power turns off or does not come on.

- The inside is too hot, or the projector has been working in an area of high temperature.
- Place the projector correctly so the intake and exhaust fans' holes are not covered.
- Turn the projector off, and leave it for a while, and turn it on again.
- Clean the air filter. **65**
- * The icon appears before the power turned off.
- * The projector returns to the standby mode after the fault display has been shown for about 2 minutes.

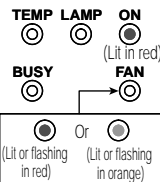

The power turns off or does not come on.

- Trouble with the cooling fan.
- Unplug the power cord and call the dealer.
- * The icon appears before the power turned off.
- * The projector returns to the standby mode after the fault display has been shown for about 2 minutes.



The power turns off or does not come on.

- The lamp cover is not properly attached.
- Unplug the power cord and reattach the lamp cover. **69**
- * The icon appears before the power turned off.
- * The projector returns to the standby mode after the fault display has been shown for about 2 minutes.

Notes

- If abnormality occurs while operating, unplug the power cord.
- When reinserting the power cord before the lamp has cooled, please wait until the lamp has cooled sufficiently before use. When the lamp is at a high temperature, it may not light and the duration life will be shortened.

Air filter cleaning

CAUTION

If you use the projector mounted on the ceiling, ask the dealer to carry out the maintenance such as cleaning.

The filter inside the air filter cover is the part to shut out dusts or dregs.

Do not use the projector with the filter taken off.

We recommend you to clean the air filter frequently. (The cleaning period is once per about 50 hours).

1 Unplug the power cord.

2

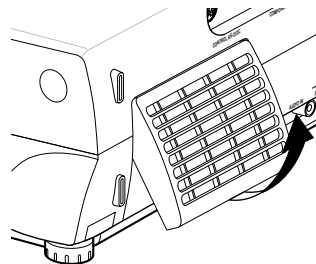

Take off the air filter cover.

The filter is on the right side of the projector. Pull the bottom side of the cover upward to remove the filter cover.

3

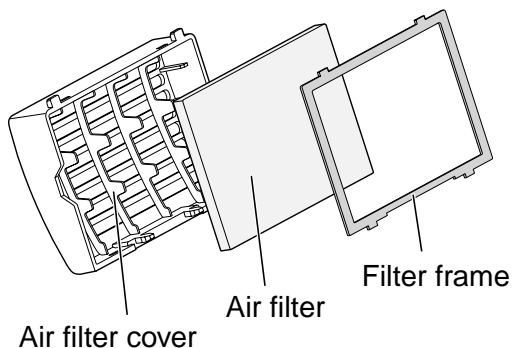

Detach the air filter.

Detach the air filter from the air filter cover. The air filter cover, air filter and filter frame can be disassembled.

4

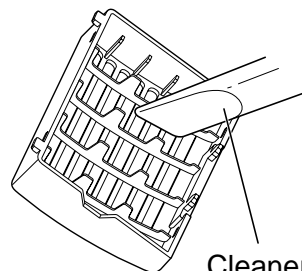

Clean the air filter.

Use a vacuum cleaner to carefully remove any dust and dirt from the air filter cover, air filter and filter frame. Be careful that the air filter is not sucked into the vacuum cleaner.

Air filter cleaning (continued)

Notes

- When the air filter is dusty, the ventilation is impaired. This causes the temperature inside the projector to rise, and may damage the unit.
- Attach the air filter cover firmly after the cleaning. If it is not set correctly, the dusts will enter and they will be projected and overlapped on the picture.
- If you wash the air filter with water, be sure to let it dry fully before reinstalling it. Using it damp will result in malfunction.
- If the air filter is damaged, contact your store of purchase and replace it with a new one. Using a damaged air filter will cause dust or dirt to get inside the projector and onto the images.

5

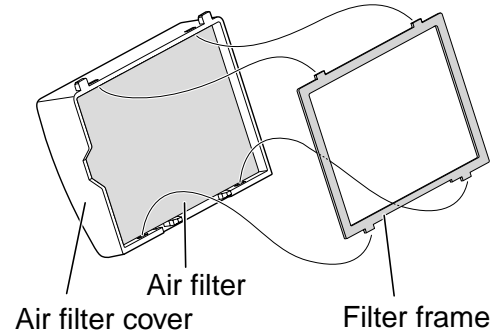

Assemble the air filter.

Place the air filter in the air filter cover, then insert the four tabs on the filter frame into the holes in the air filter cover.

6

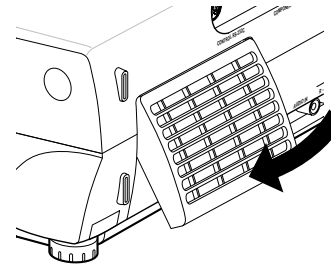

Mount the air filter cover.

Insert the top of the air filter cover into the projector first, then press on the bottom side to install it.

Lens and main unit cleaning

CAUTION

If you use the projector mounted on the ceiling, ask the dealer to carry out the maintenance such as cleaning.

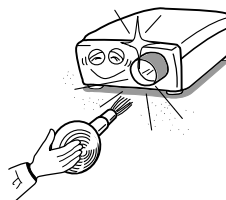

Cleaning the lens

- Use a blower or a lens cleaner to clean the lens.
- Never rub or tap the lens with a hard object as the lens surface is fragile.

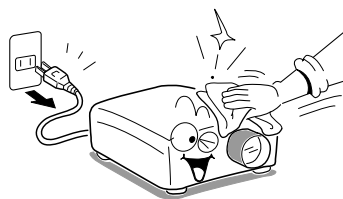

Cleaning the main unit

- Pull out the power cord before cleaning.
- Use a soft cloth to wipe off stains from the surface.
- To remove difficult stains, use a soft cloth slightly moistened with a weak solution of synthetic detergent and water, and finish with a soft, dry cloth.

Replacing the intake, exhaust fans and air filter

To maintain the efficiency of the projector, replace the intake and exhaust fans about every two to three years. Ask the dealer for the replacement.

Lamp replacement

The lamp will eventually begin to project dark or dull pictures and finally will not light up. (Lamp's life length depends on the use condition.) In such a case, replace the lamp with new one.

CAUTION

- If you use the projector mounted on the ceiling, ask the dealer to carry out the maintenance such as cleaning or replacement of the lamp.
- When replacing, always use lamp "TLPLX10" (sold separately). For detail, refer to the lamp instruction.
- If you have been using the projector, the lamp will be very hot, and may cause burn injuries. Wait for the lamp to cool (for longer than 1 hour) before replacing it.
- If the lamp should break, please handle with care to avoid injury due to broken pieces and contact your dealer for repair service.

1 Unplug the power cord.

2 Wait until the lamp gets cold enough.

3 Take off the lamp cover on the bottom panel.
Loosen two screws, and pull off the lamp cover.

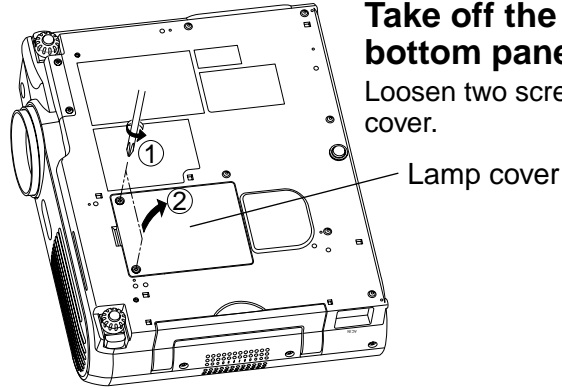

4 Pull out the lamp.
Loosen the two fixing screws, and lift up the handle to pull out the lamp.

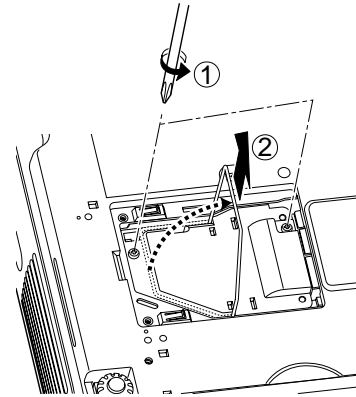

Continued

Lamp replacement (continued)

Notes

- When the **CALL** button is pressed, the “Lamp time” (the approximate amount of time the lamp has been used) is displayed. **35**
- The lamp should be replaced if the total working time exceeds about 1,000 hours.
When the “Lamp time” is displayed 1000 hours, the icon  and a message appear. They will disappear when you do some operation.
- Attach the lamp cover firmly after replacing the lamp. If it is not set correctly, the power will not turn on.
- Use a new lamp when replacing it.
- The lamp is made of glass and is very fragile. Do not touch the lamp with your bare hands and do not jolt or damage it. Do not use an exhausted lamp.
- Dispose the exhausted lamp as toxic wastes.

5 Load a new lamp.

Slide until it hits the bottom and tighten the two fixed screws.

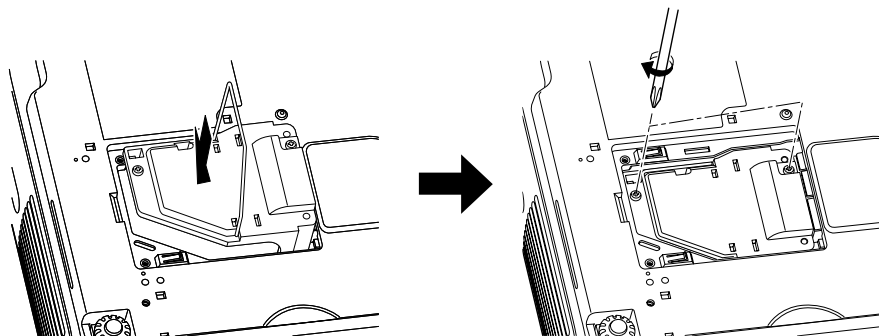

6

Attach the lamp cover.

Slide the cover in place and tighten two screws.

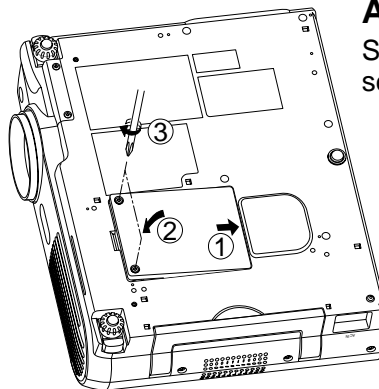



























7

Reset the lamp timer.

Refer to the lamp instructions for resetting.

Before calling service personal

Check the following points before asking for support service. Refer also to “Trouble indications”.  64

Symptom	Cause	Correction	Page
The power does not come on.	• The power cord is disconnected.	Firmly plug in the power cord.	 18
	• The lamp cover is not attached correctly.	Attach the cover correctly.	 69
The power turns off while using the projector.	• The ambient temperature of the projection room is too high.	Lower the ambient temperature of the projection room, and turn the power on.	 64
No image appears.	• The lens cover is on.	Take off the lens cover.	 18
	• The wrong input is selected.	Select the input source correctly.	 26
	• The muting mode is on.	Press MUTE to restore the picture.	 31
	• The “Brightness” adjustment is at its darkest.	Make the “Brightness” adjustment.	 38
	• The source is not correctly connected to the projector.	Connect the source correctly to the projector.	 21
No sound is heard.	• The wrong input is selected.	Select the input source correctly.	 26
	• The muting mode is on.	Press MUTE to restore the sound.	 31
	• The sound volume is at the minimum.	Adjust the sound volume.	 27
	• The source is not correctly connected to the projector.	Connect the source correctly to the projector.	 21
Desired input source cannot be selected by the INPUT button.	• Input is not set so that it can be selected with the INPUT button. By default, only the Component and Video input modes can be selected.	Set from the menu screen so that the source can be selected with the INPUT button.	 38
Computer input or Y/Pb/Pr input colors are not right.	• The COMPONENT IN connector’s input setting is wrong.	At the menu screen, set for the proper input signal type.	 38
	• The signal cable type is wrong.	Use a proper signal cable.	 21  23
Computer input or Y/Pb/Pr input image does not appear.	• The COMPONENT IN connector’s input setting is wrong.	At the menu screen, set for the proper input signal type.	 38
	• The signal cable type is wrong.	Use a proper signal cable.	 21  23
The image is blurred.	• The lens is dirty.	Clean the lens with a blower or lens cleaner, etc.	 67
Focusing is uneven.	• The picture is out of focus.	Focus the picture.	 27
	• The projection distance is not appropriate.	Adjust the distance properly.	 17
	• The projecting light is not hitting the screen squarely.	Adjust the projecting direction so that the light hits the screen squarely.	 17
	• The “Brightness”, “Contrast”, “Sharpness” or “Phase” adjustments are not correct.	Make the “Picture” adjustments.	 44
	• The “Brightness” or “Contrast” adjustments are not correct.	Make the “Picture” adjustments.	 44
The picture is dim.	• The “Brightness” or “Contrast” adjustments are not correct.	Make the “Picture” adjustments.	 44
	• The lamp life is ending.	Replace the lamp.	 68

Before calling service personal (continued)

Symptom	Cause	Correction	Page
The color is faint. The tint is not good.	• The “Color”, “Tint”, “R-Level”, “G-Level” or “B-Level” adjustments are not correct.	Make the “Picture” adjustments.	44
	• The lamp life is ending.	Replace the lamp.	68
The remote control does not work.	• The remote control is not facing the remote sensor.	Face the remote control transmitter toward the remote sensor on the projector.	15
	• The remote control is too far.	Operate within about 5 meters.	15
	• There is an obstruction between the remote control and the remote sensor.	Remove the obstacle.	-
	• The batteries are exhausted.	Replace the batteries.	14

Pin assignment of COMPONENT IN connector

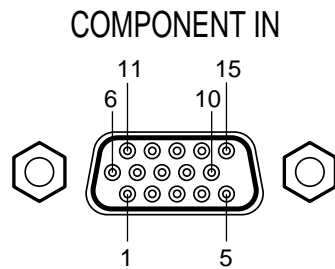

Input signal

- Y/P_B/P_R input

Y signal: 1.0V(p-p) 75Ω

P_B, P_R signal: 0.7V(p-p) 75Ω

- Computer input

R, G, B signal: 0.7V(p-p) 75Ω

H.sync signal: TTL level (positive/negative polarity)

V.sync signal: TTL level (positive/negative polarity)

Mini D-sub 15pin connector

Pin No.	Description	
	Component input	Computer input
1	Color difference signal (P _R)	Video signal (Red)
2	Luminance signal (Y)	Video signal (Green)
3	Color difference signal (P _B)	Video signal (Blue)
4	*	GND
5	*	GND
6	GND (P _R)	GND (Red)
7	GND (Y)	GND (Green)
8	GND (P _B)	GND (Blue)
9	*	N.C
10	*	GND
11	*	GND
12	*	DDC2B data
13	*	H.sync signal
14	*	V. sync signal
15	*	DDC2B clock

* : Do not connect anything.

Applicable signal

Applicable computer signal

The unit is applicable to the following signals. However, some computers may have different timings than those in the chart. Make the necessary adjustments if the picture has flickers or is blurred.

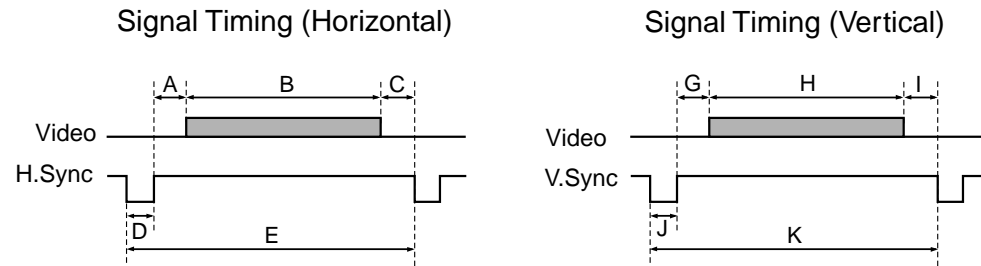

Timing chart

Mode	Resolution	A (Pixels)	B (Pixels)	C (Pixels)	D (Pixels)	E (Pixels)	fh (kHz)	fv (Hz)	clock (MHz)	G (Lines)	H (Lines)	I (Lines)	J (Lines)	K (Lines)
TEXT70	640 x 350	50	640	14	96	800	31.469	70.086	25.175	59	350	38	2	449
TEXT70	640 x 400	50	640	14	96	800	31.469	70.086	25.175	34	400	13	2	449
TEXT85	640 x 350	96	640	32	64	832	37.861	85.080	31.500	60	350	32	3	445
TEXT85	640 x 400	96	640	32	64	832	37.861	85.080	31.500	41	400	1	3	445
NEC PC98 24k	640 x 400	85	640	59	64	848	24.820	55.900	21.047	25	400	11	8	444
VGA60	640 x 480	48	640	16	96	800	31.469	59.940	25.175	33	480	10	2	525
VGA72	640 x 480	128	640	24	40	832	37.861	72.809	31.500	28	480	9	3	520
VGA75	640 x 480	120	640	16	64	840	37.500	75.000	31.500	16	480	1	3	500
VGA85	640 x 480	80	640	56	56	832	43.269	85.008	36.000	25	480	1	3	509
MAC13"	640 x 480	96	640	64	64	864	35.000	66.667	30.240	39	480	3	3	525
SVGA56	800 x 600	128	800	24	72	1024	35.156	56.250	36.000	22	600	1	2	625
SVGA60	800 x 600	88	800	40	128	1056	37.879	60.317	40.000	23	600	1	4	628
SVGA72	800 x 600	64	800	56	120	1040	48.077	72.188	50.000	23	600	37	6	666
SVGA75	800 x 600	160	800	16	80	1056	46.875	75.000	49.500	21	600	1	3	625
SVGA85	800 x 600	152	800	32	64	1048	53.674	85.061	56.250	27	600	1	3	631
MAC16"	832 x 624	216	832	40	64	1152	49.725	74.550	57.283	39	632	1	3	667
*XGA43i	1024 x 768	56	1024	8	176	1264	35.522	43.479	44.900	20	768	0	4	817
*XGA60	1024 x 768	160	1024	24	136	1344	48.363	60.004	65.000	29	768	3	6	806
*XGA70	1024 x 768	144	1024	24	136	1328	56.476	70.069	75.000	29	768	3	6	806
*XGA75	1024 x 768	176	1024	16	96	1312	60.023	75.029	78.750	28	768	1	3	800
*XGA85	1024 x 768	208	1024	48	96	1376	68.677	84.997	94.500	36	768	1	3	808
*MAC19"	1024 x 768	180	1024	20	96	1320	60.197	74.872	73.200	30	768	3	3	804

Continued

Applicable signal (continued)

Timing chart (Continued)

Mode	Resolution	A (Pixels)	B (Pixels)	C (Pixels)	D (Pixels)	E (Pixels)	fh (kHz)	fv (Hz)	clock (MHz)	G (Lines)	H (Lines)	I (Lines)	J (Lines)	K (Lines)
*SXGA1152x864 75Hz	1152 x 864	256	1152	64	128	1600	67.500	75.000	108.000	32	864	1	3	900
*SXGA1280x960 60Hz	1280 x 960	312	1280	96	112	1800	60.000	60.000	108.000	36	960	1	3	1000
*SXGA1280x960 85Hz	1280 x 960	224	1280	64	160	1728	85.938	85.002	148.500	47	960	1	3	1011
*SXGA1280x1024 60Hz	1280 x 1024	248	1280	48	112	1688	63.981	60.020	108.000	38	1024	1	3	1066
*SXGA1280x1024 75Hz	1280 x 1024	248	1280	16	144	1688	79.976	75.025	135.000	38	1024	1	3	1066
*SXGA1280x1024 85Hz	1280 x 1024	224	1280	64	160	1728	91.146	85.024	157.500	44	1024	1	3	1072
*UXGA60	1600 x 1200	304	1600	64	192	2160	75.000	60.000	162.000	46	1200	1	3	1250
*UXGA65	1600 x 1200	304	1600	64	192	2160	81.250	65.000	175.500	46	1200	1	3	1250
*UXGA70	1600 x 1200	304	1600	64	192	2160	87.500	70.000	189.000	46	1200	1	3	1250
*UXGA75	1600 x 1200	304	1600	64	192	2160	93.750	75.000	202.500	46	1200	1	3	1250

Notes

- Signal sources marked "*" are displayed in compressed format, so some of their data may be missing or their picture quality may be degraded.
- With analog RGB input if the signal source's dot clock frequency exceeds 140 MHz, not all of the pixel signals can be sampled.

The compatible Video and S-video signal

Mode	fh (kHz)	fv (Hz)	fsc (MHz)
NTSC	15.73	60	3.58
PAL	15.63	50	4.43
SECAM	15.63	50	4.25 or 4.41
PAL-M	15.73	60	3.58
PAL-N	15.63	50	3.58
PAL-60	15.73	60	4.43
NTSC4.43	15.73	60	4.43

The compatible component signal (Y/PB/PR)

Mode	fh (kHz)	fv (Hz)
480i	15.73	59.94
480p	31.47	59.94
720p	45.00	60.00
1080i	33.75	60.00

Controlling the projector by using RS-232C

You can also control the projector by entering the command from a computer via RS-232C.

Signal assignment of RS-232C

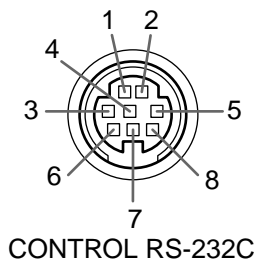

CONTROL RS-232C

Pin No.	Signal	Description
1	RXD	Receiving data
2	CTS	Consent to send
3	DSR	Data set ready
4	GND	Signal ground
5	RTS	Request to send
6	N.C	No connection
7	TXD	Sending data
8	N.C	No connection

Interface format

1	Communication method	RS-232C 9600 bps, No parity, Data length: 8 bit, Stop bit: 1 bit
2	Communication format	STX (02h) Command (3Byte) ETX (03h) One command only can be used in one communication.
3	Data format	Command shall be composed of alphanumeric characters of ASCII description. Use only capital letters.
4	Return value	Acknowledge ACK (06h) Not Acknowledge NAK (15h)

Command list

Classification	Items/Status	Selection Command	Adjustment Command	Y/PB/PR	Computer	Video/S-Video
Power	On	PON	-	Yes	Yes	Yes
	Off (with confirmation message)	POF	-	Yes	Yes	Yes
	Shut Down (without confirmation message)	PSD	-	Yes	Yes	Yes
Normal (RS-232C Condition Display Off)		DOF	-	Yes	Yes	Yes
Picture	Contrast	VCN	Yes	Yes	Yes	Yes
	Brightness	VBR	Yes	Yes	Yes	Yes
	Phase	PPH	Yes	-	Yes	-
	Frequency	PCK	Yes	-	Yes	-
	Color	VCL	Yes	Yes	-	Yes ^{*1}
	Tint	VTN	Yes	Yes ^{*2}	-	Yes
	Sharpness	VSH	Yes	Yes ^{*2}	-	Yes

Notes

- When commands are transmitted serially, keep more than 100 ms intervals between the commands.
- Adjustment commands include "ARG" (increase adjustment value) and "ALF" (decrease adjustment value). For usable items (marked "Yes"), send after the selection command.
- The "Yes" marks in the input source columns indicate that that command can be used. *1 Not possible for PAL/SECAM. *2 Not possible for 480i mode.

Continued

Controlling the projector by using RS-232C (continued)

Classification	Items/Status		Selection Command	Adjustment Command	Y/Pb/Pr	Computer	Video/S-Video
Picture	Position	H-position	PHP	Yes	-	Yes	-
		V-position	PVP	Yes	-	Yes	-
	Picture mode (Computer)	Bright	MVB	-	-	Yes	-
		True color	MVP	-	-	Yes	-
	Picture mode (Component, Video, S-Video)	Standard	PM0	-	Yes	-	Yes
		Cinema	PM1	-	Yes	-	Yes
		Sports	PM2	-	Yes	-	Yes
	Video mode	Auto.	KV0	-	-	-	Yes
		NTSC	KV1	-	-	-	Yes
		PAL	KV2	-	-	-	Yes
		SECAM	KV3	-	-	-	Yes
		PAL-N	KV4	-	-	-	Yes
		PAL-M	KV5	-	-	-	Yes
		PAL60	KV6	-	-	-	Yes
		NTSC4.43	KV7	-	-	-	Yes
	Signal format	Auto.	SG0	-	Yes	-	-
		480i	SG1	-	Yes	-	-
		480p	SG2	-	Yes	-	-
		720p	SG3	-	Yes	-	-
		1080i	SG4	-	Yes	-	-
	Screen size (Computer)	Full	MSF	-	-	Yes	-
		Thru	MST	-	-	Yes	-
	Screen size (Component, Video, S-Video)	Full	MSF	-	Yes	-	Yes
		Thru	MST	-	Yes	-	Yes
		Normal	MSN	-	Yes	-	Yes
		Zoom 1	MSV	-	Yes	-	Yes
		Zoom 2	MSC	-	Yes	-	Yes
	Level	R-level	VLR	Yes	Yes	Yes	Yes
		G-level	VLG	Yes	Yes	Yes	Yes
		B-level	VLB	Yes	Yes	Yes	Yes

Controlling the projector by using RS-232C (continued)

Classification	Items/Status		Selection Command	Adjustment Command	Y/P _B /P _R	Computer	Video/S-Video
Audio	Speaker output	On	AS1	-	Yes	Yes	Yes
		Off	AS0	-	Yes	Yes	Yes
	Channel select (RCA)	L+R	APA	-	-	-	Yes
		L	APL	-	-	-	Yes
		R	APR	-	-	-	Yes
	Loudness (RCA)	Off	LR0	-	-	-	Yes
		On	LR1	-	-	-	Yes
	Channel select (Mini)	L+R	AMA	-	Yes	Yes	-
		L	AML	-	Yes	Yes	-
		R	AMR	-	Yes	Yes	-
	Loudness (Mini)	Off	LM0	-	Yes	Yes	-
		On	LM1	-	Yes	Yes	-
Keystone	Keystone		PKS	Yes	Yes	Yes	Yes
	Horizontal reference value reset		PKR	-	Yes	Yes	Yes
Display	Language	English	LEN	-	Yes	Yes	Yes
		French	LFR	-	Yes	Yes	Yes
		German	LGR	-	Yes	Yes	Yes
		Italian	LIT	-	Yes	Yes	Yes
		Spanish	LSP	-	Yes	Yes	Yes
		Portuguese	LPO	-	Yes	Yes	Yes
		Japanese	LJP	-	Yes	Yes	Yes
		Chinese(Simplified)	LPK	-	Yes	Yes	Yes
		Chinese(Traditional)	LKT	-	Yes	Yes	Yes
		Korean	LKK	-	Yes	Yes	Yes
	No signal background	Logo	BG0	-	Yes	Yes	Yes
		Blue background	BG1	-	Yes	Yes	Yes
		Non	BG2	-	Yes	Yes	Yes
	Icon	On	MO0	-	Yes	Yes	Yes
		Off	MO1	-	Yes	Yes	Yes
	Menu position	Upper left	MP1	-	Yes	Yes	Yes
		Lower left	MP2	-	Yes	Yes	Yes
		Upper right	MP3	-	Yes	Yes	Yes
		Lower right	MP4	-	Yes	Yes	Yes

Continued

Controlling the projector by using RS-232C (continued)

Classification	Items/Status		Selection Command	Adjustment Command	Y/Pb/Pr	Computer	Video/S-Video
Display	Menu background translucent	On	MB1	-	Yes	Yes	Yes
		Off	MB0	-	Yes	Yes	Yes
	Start-up screen	On	MS0	-	Yes	Yes	Yes
		Off	MS1	-	Yes	Yes	Yes
Default setting	Input source setting						
	COMPONENT	On	I10	-	Yes	Yes	Yes
		Off	I11	-	Yes	Yes	Yes
		Computer	IS0	-	Yes	Yes	Yes
		Component	IS1	-	Yes	Yes	Yes
	VIDEO	On	I30	-	Yes	Yes	Yes
		Off	I31	-	Yes	Yes	Yes
	S-VIDEO	On	I40	-	Yes	Yes	Yes
		Off	I41	-	Yes	Yes	Yes
	Projection mode	Standard	PJ0	-	Yes	Yes	Yes
		Rear	PJ1	-	Yes	Yes	Yes
		Ceiling	PJ2	-	Yes	Yes	Yes
		Rear ceiling	PJ3	-	Yes	Yes	Yes
	No signal power off	Off	PN0	-	Yes	Yes	Yes
		5 min.	PN1	-	Yes	Yes	Yes
	Power on	Manual	AP0	-	Yes	Yes	Yes
		Auto.	AP1	-	Yes	Yes	Yes
	Factory reset mode	Picture only	DRV	-	Yes	Yes	Yes
		All	DRS	-	Yes	Yes	Yes
	Status display (CALL)			DON	-	Yes	Yes

Controlling the projector by using RS-232C (continued)

Classification	Items/Status		Selection Command	Adjustment Command	Y/P _B /P _R	Computer	Video/S-Video
Volume	Increase		VLU	-	Yes	Yes	Yes
	Decrease		VLD	-	Yes	Yes	Yes
Input select	Toggle		IN0	-	Yes	Yes	Yes
	COMPONENT		IN1	-	Yes	Yes	Yes
	VIDEO		IN3	-	Yes	Yes	Yes
	S-VIDEO		IN4	-	Yes	Yes	Yes
RESIZE	Increase the enlargement ratio		RUP	-	Yes	Yes	Yes
	Decrease the enlargement ratio (Minimum: reset status)		RDW	-	Yes	Yes	Yes
	Move the enlargement section	Upper	PO1	-	Yes	Yes	Yes
		Lower	PO2	-	Yes	Yes	Yes
		Lefter	PO3	-	Yes	Yes	Yes
		Righter	PO4	-	Yes	Yes	Yes
Enlargement reset		RS0	-	Yes	Yes	Yes	
FREEZE	On		FON	-	Yes	Yes	Yes
	Off		FOF	-	Yes	Yes	Yes
MUTE	On		MON	-	Yes	Yes	Yes
	Off		MOF	-	Yes	Yes	Yes
PIP	On		PIN	-	-	Yes	-
	Off		PIF	-	-	Yes	-
	PIP input source	Video	PI0	-	-	Yes	-
		S-Video	PI1	-	-	Yes	-
	PIP size	Small	PS0	-	-	Yes	-
		Large	PS1	-	-	Yes	-
	PIP position	Upper left	PP0	-	-	Yes	-
		Upper right	PP1	-	-	Yes	-
		Lower left	PP2	-	-	Yes	-
		Lower right	PP3	-	-	Yes	-
	PIP audio input source	Main	PA0	-	-	Yes	-
Sub		PA1	-	-	Yes	-	
AUTO SET			PAT	-	-	Yes	-
AUTO KEYSTONE			PKA	-	Yes	Yes	Yes

Specifications

Main unit

Power consumption	265W (Standby: 18W)
Mass	5.3kg
Dimensions (Except the protrusion parts)	345 x 104 x 281 (mm) (W/H/D)
Cabinet Material	ABS resin
Ambient environment	Temperature : 0°C to 35°C Humidity : 30% to 70% RH
Lamp	High pressure mercury lamp
Projection screen size	28 to 250 inches
Projection distance	1.38 to 9.83m
Speaker	2W (monaural)
Connectors	
• COMPONENT IN	Mini D-sub 15-pin Y/PB/PR/Computer (combination)
• S-VIDEO IN	Mini DIN 4-pin
• VIDEO IN	1V(p-p), 75Ω, RCA pin jack
• AUDIO (L/R)	1V(p-p), more than 22kΩ, RCA pin jack x 2
• AUDIO IN	1V(p-p), more than 22kΩ, ø3.5mm stereo mini jack
• CONTROL	Mini DIN 8-pin (RS-232C)

Liquid crystal display

Projection system	3-panels transmission
Panel size	1.3 inches
Driving system	TFT active matrix
Picture elements	921,600 pixels (1280 x 720 dots) (H./V.) x 3

Trademarks

NEC, PC-98 series are trademarks of NEC Corporation.

VGA, SVGA, XGA, SXGA, UXGA are trademarks or registered trademarks of International Business Machines Corporation.

Macintosh is a registered trademark of Apple Computer, Inc.

Windows is a registered trademark of Microsoft Corporation in the U.S. and other countries.

Display Data Channel is a trademark of Video Electronics Standard Association.

Projection lens

Lens	Zooming lens F = 2.2 to 2.5, f = 47 to 61mm
Focusing	Manual operation
Zooming	Manual operation

Accessories

Owner's manual	1
Remote control	1
R6 (AA) size battery	2
Power cord	2
AV cable	1 (3m)
Audio cable (for Component)	1 (3m)
Control cable	1 (1.8m)

Sold separately

Replacement lamp TLPLX10

- The design and specifications are subject to change without notice.