

HDR-CX110E/CX115E/CX116E/ CX150E/CX155E/XR150E/XR155E

Digital HD Video Camera Recorder
Operating Guide

AVCHD HDMI



CLASS 4

CLASS 4

Table of contents	10
Getting started	12
Recording/Playback	21
Making good use of your camcorder	32
Saving movies and photos with a computer	34
Saving images with an external device	45
Customizing your camcorder	54
Additional information	62
Quick reference	71

HANDYCAM®

Read this first

Before operating the unit, please read this manual thoroughly, and retain it for future reference.

WARNING

To reduce fire or shock hazard, do not expose the unit to rain or moisture.

Do not expose the batteries to excessive heat such as sunshine, fire or the like.

CAUTION

Battery pack

If the battery pack is mishandled, the battery pack can burst, cause a fire or even chemical burns. Observe the following cautions.

- Do not disassemble.
- Do not crush and do not expose the battery pack to any shock or force such as hammering, dropping or stepping on it.
- Do not short circuit and do not allow metal objects to come into contact with the battery terminals.
- Do not expose to high temperature above 60°C (140°F) such as in direct sunlight or in a car parked in the sun.
- Do not incinerate or dispose of in fire.
- Do not handle damaged or leaking lithium ion batteries.
- Be sure to charge the battery pack using a genuine Sony battery charger or a device that can charge the battery pack.
- Keep the battery pack out of the reach of small children.
- Keep the battery pack dry.
- Replace only with the same or equivalent type recommended by Sony.
- Dispose of used battery packs promptly as described in the instructions.

Replace the battery with the specified type only. Otherwise, fire or injury may result.

AC Adaptor



Do not use the AC Adaptor placed in a narrow space, such as between a wall and furniture.

Use the nearby wall outlet (wall socket) when using the AC Adaptor. Disconnect the AC Adaptor from the wall outlet (wall socket) immediately if any malfunction occurs while using your camcorder.

Even if your camcorder is turned off, AC power source (mains) is still supplied to it while connected to the wall outlet (wall socket) via the AC Adaptor.

Notice for customers in the United Kingdom

A moulded plug complying with BS 1363 is fitted to this equipment for your safety and convenience.

Should the fuse in the plug supplied need to be replaced, a fuse of the same rating as the supplied one and approved by ASTA or BSI to BS 1362, (i.e., marked with an  or  mark) must be used. If the plug supplied with this equipment has a detachable fuse cover, be sure to attach the fuse cover after you change the fuse. Never use the plug without the fuse cover. If you should lose the fuse cover, please contact your nearest Sony service station.

FOR CUSTOMERS IN EUROPE

Notice for the customers in the countries applying EU Directives

The manufacturer of this product is Sony Corporation, 1-7-1 Konan Minato-ku Tokyo, 108-0075 Japan. The Authorized Representative for EMC and product safety is Sony Deutschland GmbH, Hedelfinger Strasse 61, 70327 Stuttgart, Germany. For any service or guarantee matters please refer to the addresses given in separate service or guarantee documents.

ATTENTION

The electromagnetic fields at the specific frequencies may influence the picture and sound of this unit.

This product has been tested and found compliant with the limits set out in the EMC Directive for using connection cables shorter than 3 meters (9.8 feet).

Notice

If static electricity or electromagnetism causes data transfer to discontinue midway (fail), restart the application or disconnect and connect the communication cable (USB, etc.) again.



Disposal of Old Electrical & Electronic Equipment (Applicable in the European Union and other European countries with separate collection systems)

This symbol on the product or on its packaging indicates that this product shall not be treated as household waste. Instead it shall be handed over to the applicable collection point for the recycling of electrical and electronic equipment.

By ensuring this product is disposed of correctly, you will help prevent potential negative consequences for the environment and human health, which could otherwise be caused by inappropriate waste handling of this product. The recycling of materials will help to conserve natural resources. For more detailed information about recycling of this product, please contact your local Civic Office, your household waste disposal service or the shop where you purchased the product.



Disposal of waste batteries (applicable in the European Union and other European countries with separate collection systems)

This symbol on the battery or on the packaging indicates that the battery provided with this product shall not be treated as household waste.

On certain batteries this symbol might be used in combination with a chemical symbol. The chemical symbols for mercury (Hg) or lead (Pb) are added if the battery contains more than 0.0005% mercury or 0.004% lead.

By ensuring these batteries are disposed of correctly, you will help prevent potentially negative consequences for the environment and human health which could otherwise be caused by inappropriate waste handling of the battery. The recycling of the materials will help to conserve natural resources.

In case of products that for safety, performance or data integrity reasons require a permanent connection with an incorporated battery, this battery should be replaced by qualified service staff only. To ensure that the battery will be treated properly, hand over the product at end-of-life to the applicable collection point for the recycling of electrical and electronic equipment.

For all other batteries, please view the section on how to remove the battery from the product safely. Hand the battery over to the applicable collection point for the recycling of waste batteries.

For more detailed information about recycling of this product or battery, please contact your local Civic Office, your household waste disposal service or the shop where you purchased the product.

For customers in the U.S.A.

If you have any questions about this product, you may call:
Sony Customer Information Center 1-800-222-SONY (7669).
The number below is for the FCC related matters only.

Regulatory Information

Declaration of Conformity

Trade Name: SONY
Model No.: HDR-CX110E
Responsible Party: Sony Electronics Inc.
Address: 16530 Via Esprillo, San Diego, CA 92127 U.S.A.
Telephone No.: 858-942-2230
This device complies with Part 15 of the FCC Rules. Operation is subject to the following two conditions: (1) This device may not cause harmful interference, and (2) this device must accept any interference received, including interference that may cause undesired operation.

Declaration of Conformity

Trade Name: SONY
Model No.: HDR-CX150E
Responsible Party: Sony Electronics Inc.
Address: 16530 Via Esprillo, San Diego, CA 92127 U.S.A.
Telephone No.: 858-942-2230
This device complies with Part 15 of the FCC Rules. Operation is subject to the following two conditions: (1) This device may not cause harmful interference, and (2) this device must accept any interference received, including interference that may cause undesired operation.

Declaration of Conformity

Trade Name: SONY
Model No.: HDR-XR150E
Responsible Party: Sony Electronics Inc.
Address: 16530 Via Esprillo, San Diego, CA 92127 U.S.A.
Telephone No.: 858-942-2230
This device complies with Part 15 of the FCC Rules. Operation is subject to the following two conditions: (1) This device may not cause harmful interference, and (2) this device must accept any interference received, including interference that may cause undesired operation.

CAUTION

You are cautioned that any changes or modifications not expressly approved in this manual could void your authority to operate this equipment.

Note

This equipment has been tested and found to comply with the limits for a Class B digital device, pursuant to Part 15 of the FCC Rules.

These limits are designed to provide reasonable protection against harmful interference in a residential installation. This equipment generates, uses, and can radiate radio frequency energy and, if not installed and used in accordance with the instructions, may cause harmful interference to radio communications. However, there is no guarantee that interference will not occur in a particular installation. If this equipment does cause harmful interference to radio or television reception, which can be determined by turning the equipment off and on, the user is encouraged to try to correct the interference by one or more of the following measures:

- Reorient or relocate the receiving antenna.
- Increase the separation between the

equipment and receiver.

- Connect the equipment into an outlet on a circuit different from that to which the receiver is connected.
- Consult the dealer or an experienced radio/TV technician for help.

The supplied interface cable must be used with the equipment in order to comply with the limits for a digital device pursuant to Subpart B of Part 15 of FCC Rules.

Battery pack

This device complies with Part 15 of the FCC Rules. Operation is subject to the following two conditions: (1) This device may not cause harmful interference, and (2) this device must accept any interference received, including interference that may cause undesired operation.

Supplied items

The numbers in () are the supplied quantity.

- AC Adaptor (1)
- Power cord (Mains lead) (1)
- Component A/V cable (1) **A**
- A/V connecting cable (1) **B**
- USB cable (1) **C**
- Rechargeable battery pack NP-FV50 (1)
- CD-ROM “Handycam” Application Software (1) (p. 35)
 - “PMB” (software, including “PMB Help”)
 - “Handycam” Handbook (PDF)
- “Operating Guide” (This manual) (1)

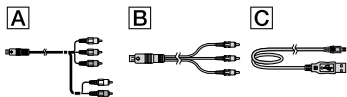

- See page 18 for the memory card you can use with this camcorder.

Using the camcorder

- Do not hold the camcorder by the following parts, and also do not hold the camcorder by the jack covers.

LCD Screen

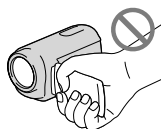

Battery pack

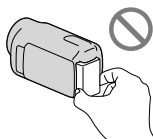

- The camcorder is not dustproofed, dripproofed or waterproofed. See “Precautions” (p. 64).

Menu items, LCD panel, and lens

- A menu item that is grayed out is not available under the current recording or playback conditions.
- The LCD screen is manufactured using extremely high-precision technology, so over 99.99% of the pixels are operational for effective use. However, there may be some tiny black points and/or bright points (white, red, blue, or green in color) that appear constantly on the LCD screen. These points are normal results of the manufacturing process and do not affect the recording in any way.

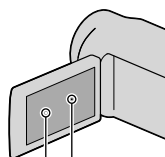

Black points

White, red, blue or green points

- Exposing the LCD screen or the lens to direct sunlight for long periods of time may cause malfunctions.
- Do not aim at the sun. Doing so might cause your camcorder to malfunction. Take images of the sun only in low light conditions, such as at dusk.

About language setting

- The on-screen displays in each local language are used for illustrating the operating procedures. Change the screen language before using the camcorder if necessary (p. 16).

On recording

- To ensure stable operation of the memory card, it is recommended to initialize the memory card with your camcorder before the first use. Initializing the memory card will erase all the data stored on it and the data will be irrecoverable. Save your important data on your PC etc.
- Before starting to record, test the recording function to make sure the image and sound are recorded without any problems.
- Compensation for the contents of recordings cannot be provided, even if recording or playback is not possible due to a malfunction of the camcorder, recording media, etc.
- TV color systems differ depending on the country/region. To view your recordings on a TV, you need a PAL system-based TV.
- Television programs, films, video tapes, and other materials may be copyrighted. Unauthorized recording of such materials may be contrary to the copyright laws.

Notes on playing back

- The camcorder is compatible with MPEG-4 AVC/H.264 High Profile for high definition image quality (HD) recording. Therefore, you cannot play back images recorded with high definition image quality (HD) on the camcorder with the following devices;
 - Other AVCHD format compatible devices which are not compatible with High Profile

– Devices which are not compatible with the AVCHD format

- You may not be able to play back normally images recorded on your camcorder with other devices. Also, you may not be able to play back images recorded on other devices with your camcorder.
- Standard (STD) image quality movies recorded on SD memory cards cannot be played on AV equipment of other manufacturers.

Discs recorded with HD image quality (high definition)

- This camcorder captures high definition footage in the AVCHD format. DVD media containing AVCHD footage should not be used with DVD based players or recorders, as the DVD player/recorder may fail to eject the media and may erase its contents without warning. DVD media containing AVCHD footage may be played on a compatible Blu-ray Disc™ player/recorder or other compatible device.

Save all your recorded image data

- To prevent your image data from being lost, save all your recorded images on external media periodically. It is recommended that you save the image data on a disc such as DVD-R, etc. using your computer. Also, you can save your image data using a VCR, or a DVD/HDD recorder (p. 47).
- You cannot make a AVCHD disc from the image data recorded with **MENU** (MENU) → [Show others] → [REC MODE] (under  [SHOOTING SET] category) set to [HD FX]. Save them on a Blu-ray Disc or using an external media (p. 43, 45).

Notes on battery pack/AC Adaptor

- Be sure to remove the battery pack or the AC Adaptor after turning off the camcorder.
- Disconnect the AC Adaptor from the camcorder, holding both the camcorder and the DC plug.

Note on the camcorder/battery pack temperature

- When the temperature of the camcorder or battery pack becomes extremely high or extremely low, you may not be able to record or play back on the camcorder, due to the protection features of the camcorder being activated in such situations. In this case, an indicator appears on the LCD screen.

When the camcorder is connected to a computer or accessories

- Do not try to format the recording media of the camcorder using a computer. If you do so, your camcorder may not operate correctly.
- When connecting the camcorder to another device with communication cables, be sure to insert the connector plug in the correct way. Pushing the plug forcibly into the terminal will damage the terminal and may result in a malfunction of the camcorder.

If you cannot record/play back images, perform [MEDIA FORMAT]

- If you repeat recording/deleting images for a long time, fragmentation of data occurs on the recording media. Images cannot be saved or recorded. In such a case, save your images on some type of external media first, and then perform [MEDIA FORMAT] by touching **MENU** (MENU) → [Show others] → [MEDIA FORMAT] (under [MANAGE MEDIA] category) → the desired medium (HDR-CX116E/CX150E/CX155E/XR150E/XR155E) → [YES] → [YES] → **OK**.

Carl Zeiss lens

- Your camcorder is equipped with a Carl Zeiss lens, which was developed jointly by Carl Zeiss, in Germany, and Sony Corporation, and produces superior images. It adopts the MTF measurement system for video cameras and offers a quality typical of a Carl Zeiss lens. MTF= Modulation Transfer Function. The number value indicates the amount of light from a subject coming into the lens.

Notes on optional accessories

- We recommend using genuine Sony accessories.
- Genuine Sony accessories may not be available in some countries/regions.

About this manual, illustrations and on-screen displays



- The example images used in this manual for illustration purposes are captured using a digital still camera, and therefore may appear different from images and screen indicators that actually appear on your camcorder. And, the illustrations of your camcorder and its screen indication are exaggerated or simplified for understandability.
- In this manual, the internal memory (HDR-CX116E/CX150E/CX155E) and the hard disk (HDR-XR150E/XR155E) of the camcorder and the memory card are called “recording media.”
- In this manual, the DVD disc recorded with high definition image quality (HD) is called AVCHD disc.
- Design and specifications of your camcorder and accessories are subject to change without notice.

Confirm the model name of your camcorder

- The model name is shown in this manual when there is a difference in specification between models. Confirm the model name on the bottom of your camcorder.
- The main differences in specification of this series are as follows.

	Recording media	Capacity of internal recording media	USB jack
HDR-CX110E	Memory card	—	Input/output
HDR-CX115E			Output only
HDR-CX116E	Internal memory + memory card	8GB	Output only
HDR-CX150E		16GB	Input/output
HDR-CX155E			Output only
HDR-XR150E	Internal hard disk + memory card	120GB	Input/output
HDR-XR155E			Output only

Notes on use

- Do not do any of the following. Otherwise, the recording media may be damaged, recorded images may be impossible to play back or may be lost, or other malfunctions could occur.
 - ejecting the memory card when the access lamp (p. 19) is lit or flashing
 - removing the battery pack or AC Adaptor from the camcorder, or applying mechanical shock or vibration to the camcorder when the  (Movie)/ (Photo) lamps (p. 22) or the access lamp (p. 19) are lit or flashing
- When using a shoulder belt (sold separately), do not crash the camcorder against an object.
- Do not use your camcorder in very loud areas.

On the drop sensor (HDR-XR150E/XR155E)

- To protect the internal hard disk from shock by dropping, the camcorder has a drop sensor function. When a drop occurs, or under a non-gravity condition, the block noise made when this function is activated by the camcorder may also be recorded. If the drop sensor catches a drop repeatedly, recording/playback may be stopped.

Note on using the camcorder at high altitudes (HDR-XR150E/XR155E)

- Do not turn on the camcorder in a low-pressure area, where the altitude is more than 5,000 meters (16,000 feet). Doing so may damage the internal hard disk drive of your camcorder.

Operation flow

Getting started (p. 12)

Prepare the power source and memory card.

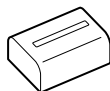

Recording movies and photos (p. 21)

Recording movies → p. 23

💡 Changing the recording mode

💡 Expected recording time(MEDIA INFO)

Shooting photos → p. 25



Playing movies and photos

Playback on the camcorder → p. 26

Playing images on a TV → p. 29

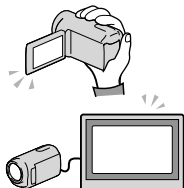

Saving images

Saving movies and photos with a computer → p. 34

Saving movies and photos in external media → p. 45

Saving images with a DVD writer/recorder → p. 47

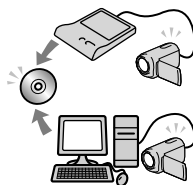

Deleting movies and photos (p. 32)

If you delete the image data that has been saved on your computer or a disc, you can record new images on the free media space again.



Table of contents

Read this first	2
Operation flow	9
Getting started	
Step 1: Charging the battery pack	12
Charging the battery pack abroad	14
Step 2: Turning the power on, and setting the date and time	15
Changing the language setting	16
Step 3: Preparing the recording media	17
To check the recording media settings	18
Dubbing or copying movies and photos from the internal recording media to memory card (HDR-CX116E/CX150E/CX155E/XR150E/XR155E)	20
Recording/Playback	
Recording	21
Playback on the camcorder	26
Playing images on a TV	29
Making good use of your camcorder	
Deleting movies and photos	32
Saving movies and photos with a computer	
Preparing a computer (Windows)	34
When using a Macintosh	35
Starting PMB (Picture Motion Browser)	37
Selecting the method for creating a disc (computer)	38
Creating a disc with one touch (One Touch Disc Burn)	40
Importing movies and photos to a computer	41
Creating an AVCHD disc	42
Playing an AVCHD disc on a computer	42
Creating a Blu-ray disc	43
Creating a standard definition image quality (STD) disc that can be played on ordinary DVD players	43
Copying a disc	44
Editing movies	44
Capturing photos from a movie	44
Saving images with an external device	
Saving images in external media (DIRECT COPY)	45
Creating a disc with a DVD writer, recorder	47

■ Customizing your camcorder	
Using menus	54
Getting detailed information from the “Handycam” Handbook	61
■ Additional information	
? Troubleshooting	62
Precautions	64
Specifications	66
■ Quick reference	
Screen indicators	71
Parts and controls	72
Index	75

Step 1: Charging the battery pack

HDR-CX110E/CX115E/CX116E/CX150E/CX155E

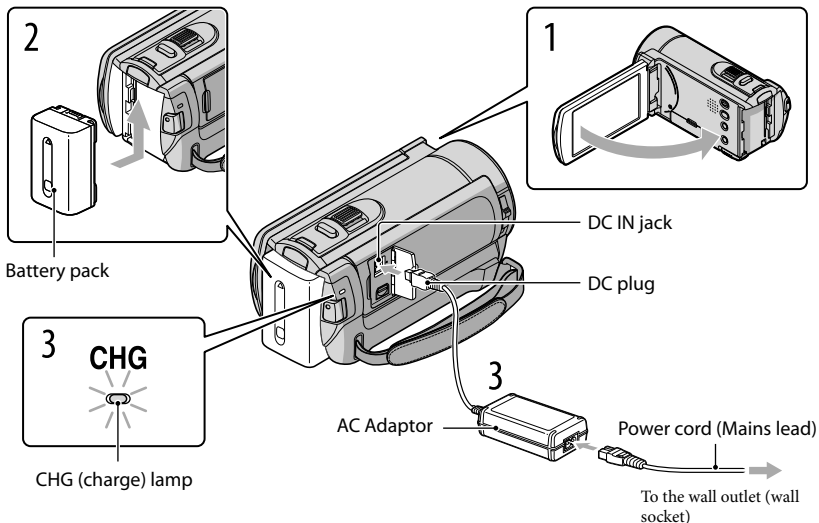

HDR-XR150E/XR155E

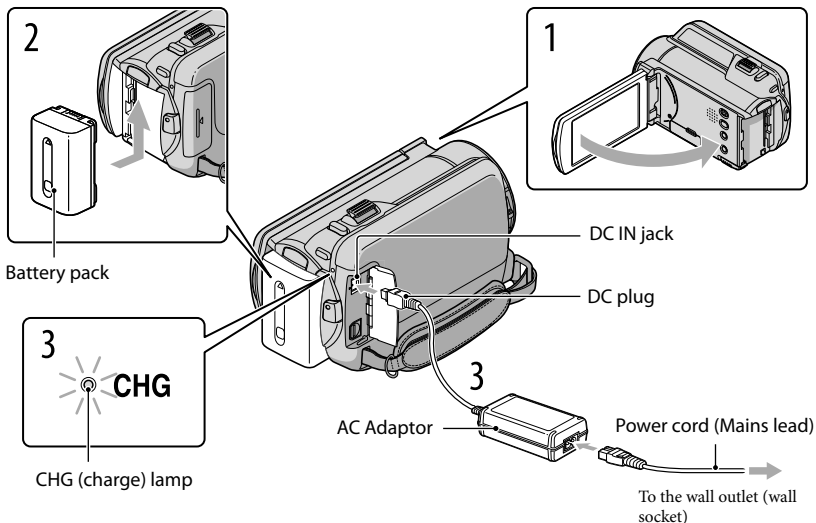

You can charge the “InfoLITHIUM” battery pack (V series) after attaching it to your camcorder.

⚡ Notes

- You cannot attach any “InfoLITHIUM” battery pack other than the V series to your camcorder.

1

Turn off your camcorder by closing the LCD screen.

2

Attach the battery pack by sliding it in the direction of the arrow until it clicks.

3

Connect the AC Adaptor and the power cord (mains lead) to your camcorder and the wall outlet (wall socket).

- Align the ▲ mark on the DC plug with that on the DC IN jack.

The CHG (charge) lamp lights up and charging starts. The CHG (charge) lamp turns off when the battery pack is fully charged.

4

When the battery is charged, disconnect the AC Adaptor from the DC IN jack of your camcorder.

💡 Tips

- See page 68 on recording and playing time.
- When your camcorder is on, you can check the approximate amount of remaining battery power with the remaining battery indicator at the upper left on the LCD screen.

To remove the battery pack

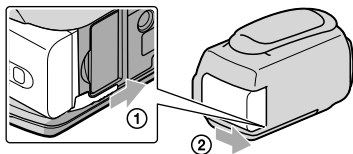

Close the LCD screen. Slide the BATT (battery) release lever (①) and remove the battery pack (②).



To use a wall outlet (wall socket) as a power source

Make the same connections as “Step 1: Charging the battery pack.” Even if the battery pack is attached, the battery pack is not discharged.

Notes on the battery pack

- When you remove the battery pack or disconnect the AC Adaptor, close the LCD screen and make sure that the  (Movie)/ (Photo) lamps (p. 22), the access lamp (p. 19) are turned off.
- The CHG (charge) lamp flashes during charging under the following conditions:
 - The battery pack is not attached correctly.
 - The battery pack is damaged.
 - The temperature of the battery pack is low.
Remove the battery pack from your camcorder and put it in a warm place.
 - The temperature of the battery pack is high.
Remove the battery pack from your camcorder and put it in a cool place.
- We do not recommend using an NP-FV30, which only allows short recording and playback times, with your camcorder.
- In the default setting, the power turns off automatically if you leave your camcorder without any operation for about 5 minutes, to save battery power ([A.SHUT OFF]).

Notes on the AC Adaptor

- Use the nearby wall outlet (wall socket) when using the AC Adaptor. Disconnect the AC Adaptor from the wall outlet (wall socket) immediately if any malfunction occurs while using your camcorder.
- Do not use the AC Adaptor placed in a narrow space, such as between a wall and furniture.
- Do not short-circuit the DC plug of the AC Adaptor or battery terminal with any metallic objects. This may cause a malfunction.

Charging the battery pack abroad

You can charge the battery pack in any countries/regions using the AC Adaptor supplied with your camcorder within the AC 100 V - 240 V, 50 Hz/60 Hz range.

- Do not use an electronic voltage transformer.

Step 2: Turning the power on, and setting the date and time

1 Open the LCD screen of your camcorder.

Your camcorder is turned on.

- To turn on your camcorder when the LCD screen is open, press POWER.

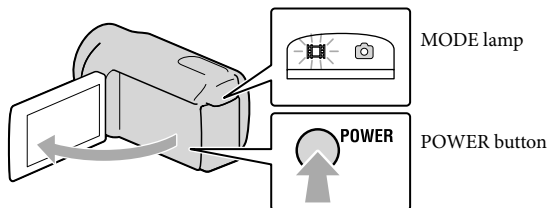

2 Select the desired geographical area with **▲**/**▼**, then touch [NEXT].

Touch the button on the LCD screen

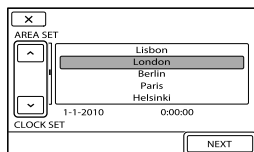
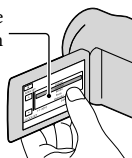

- To set the date and time again, touch **MENU** (MENU) → [Show others] → [CLOCK/ **LANG**] (under **GENERAL SET** category) → [CLOCK SET]. When an item is not on the screen, touch **▲**/**▼** until the item appears.



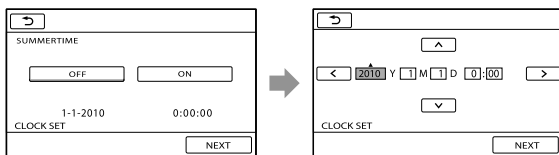

3 Set [SUMMERTIME], date and time, then touch **OK**.

The clock starts.

- If you set [SUMMERTIME] to [ON], the clock advances 1 hour.



Notes

- The date and time does not appear during recording, but they are automatically recorded on the recording media, and can be displayed during playback. To display the date and time, touch **MENU** (MENU) → [Show others] → [PLAYBACK SET] (under  [PLAYBACK] category) → [DATA CODE] → [DATE/TIME] → **OK** →  → **X**.
- You can turn off the operation beeps by touching **MENU** (MENU) → [Show others] → [SOUND/DISP SET] (under  [GENERAL SET] category) → [BEEP] → [OFF] → **OK** →  → **X**.
- If the button you touch does not react correctly, calibrate the touch panel.

To turn off the power





Close the LCD screen. The  (Movie) lamp flashes for a few seconds and the power is turned off.

Tips

- You can turn off your camcorder also by pressing POWER.
- When [POWER ON BY LCD] is set to [OFF], turn off your camcorder by pressing POWER.

Changing the language setting

You can change the on-screen displays to show messages in a specified language.

Touch **MENU** (MENU) → [Show others] → [CLOCK/ LANG] (under  [GENERAL SET] category) → [ LANGUAGE SET] → a desired language → **OK** →  → **X**.

Step 3: Preparing the recording media

The recording media that can be used differs depending on your camcorder. The following icons are displayed on the screen of your camcorder.

HDR-CX110E/CX115E



Memory
card

HDR-CX116E/CX150E/CX155E



Internal
memory



Memory
card

HDR-XR150E/XR155E



Internal hard
disk



Memory
card

* In the default setting, both movies and photos are recorded on this recording media. You can perform recording, playback and editing operations on the selected medium.

Tips

- See page 68 for the recordable time of movies.

Selecting the recording media for movies (HDR-CX116E/CX150E/CX155E/
XR150E/XR155E)

- 1 Touch **MENU** (MENU) → [Show others] → [MEDIA SETTINGS] (under [MANAGE MEDIA] category) → [MOVIE MEDIA SET].

The [MOVIE MEDIA SET] screen appears.

- 2 Touch the desired recording media.

- 3 Touch [YES] → **OK**.

The recording medium is changed.

Selecting the recording media for photos (HDR-CX116E/CX150E/CX155E/XR150E/XR155E)

- 1 Touch **MENU** (MENU) → [Show others] → [MEDIA SETTINGS] (under  [MANAGE MEDIA] category) → [PHOTO MEDIA SET].

The [PHOTO MEDIA SET] screen appears.

- 2 Touch the desired recording media.

- 3 Touch [YES] → **OK**.

The recording medium is changed.

To check the recording media settings

In either movie recording mode or photo recording mode, the media icon of the selected recording media is displayed at the top right corner of the screen.

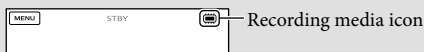

- The icon displayed may vary depending on your model.

Inserting a memory card

Notes

- Set the recording medium to [MEMORY CARD] to record movies and/or photos on a memory card (HDR-CX116E/CX150E/CX155E/XR150E/XR155E).

Types of memory card you can use with your camcorder

- You can use the following memory cards for this camcorder; “Memory Stick PRO Duo” (Mark2) media, “Memory Stick PRO-HG Duo” media, SD memory cards, SDHC memory cards, SDXC memory cards (Speed Class 4 or faster is required for each SD card). However, operation with all memory cards is not assured.
- “Memory Stick PRO Duo” media of up to 32 GB and SD cards of up to 64 GB have been verified to operate with your camcorder.
- In this manual, “Memory Stick PRO Duo” (Mark2) media and “Memory Stick PRO-HG Duo” media are called “Memory Stick PRO Duo” media. SD memory card, SDHC memory card and SDXC memory card are called SD card.

Notes

- A MultiMediaCard cannot be used with this camcorder.

- Movies recorded on SDXC memory cards cannot be imported to or played back on computers or A/V devices not supporting the exFAT* file system by connecting the camcorder to these devices with the USB cable. Confirm in advance that the connecting equipment is supporting the exFAT system. If you connect an equipment not supporting the exFAT system and the format screen appears, do not perform the format. All the data recorded will be lost.

* The exFAT is a file system that is used for SDXC memory cards.

Size of memory card you can use with your camcorder

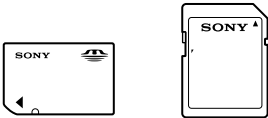

- “Memory Stick PRO Duo” media, half the size of “Memory Stick”, or standard size SD cards can be used for this camcorder.
- Do not attach a label or the like on memory card or memory card adaptor. Doing so may cause a malfunction.

Open the cover, and insert the memory card with the notched edge in the direction as illustrated until it clicks.

- Close the cover after inserting the memory card.

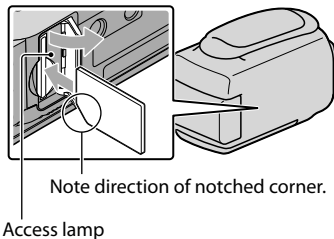

The [Create a new Image Database File.] screen may appear if you insert a new memory card. In that case, touch [YES]. If you record only photos on the memory card, touch [NO].

- Confirm the direction of the memory card. If you forcibly insert the memory card in the wrong direction, the memory card, memory card slot, or image data may be damaged.

⚡ Notes

- If [Failed to create a new Image Database File. It may be possible that there is not enough free space.] is displayed, format the memory card by touching **MENU** (MENU) → [Show others] → [MEDIA FORMAT] (under [MANAGE MEDIA] category) → [MEMORY CARD] (HDR-CX116E/CX150E/CX155E/XR150E/XR155E) → [YES] → [YES] → **OK**.

To eject the memory card

Open the cover and lightly push the memory card in once.

- Do not open the cover during recording.
- When inserting or ejecting the memory card, be careful so that the memory card does not pop out and drop.

Dubbing or copying movies and photos from the internal recording media to memory card (HDR-CX116E/CX150E/CX155E/XR150E/XR155E)

Touch **MENU** (MENU) → [Show others] → [MOVIE DUB]/[PHOTO COPY] (under  [EDIT] category), then follow the displays on the screen.

Recording

In the default setting, movies are recorded with high definition image quality (HD) on the following media.

HDR-CX110E/CX115E: Memory card

HDR-CX116E/CX150E/CX155E: Internal memory

HDR-XR150E/XR155E: Internal hard disk

Tips

- To change the recording media, see page 17 (HDR-CX116E/CX150E/CX155E/XR150E/XR155E).

To open the lens cover

Slide the LENS COVER switch to open.

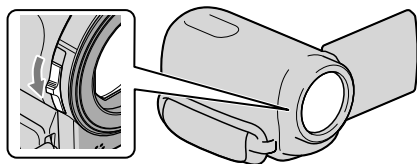

Tips

- When you finish recording or when you play back images, close the lens cover.

1

Fasten the grip belt.

HDR-CX110E/CX115E/CX116E/CX150E/CX155E

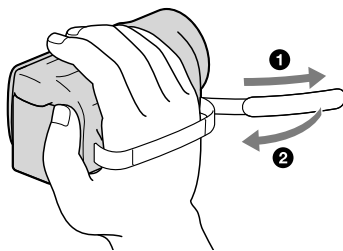

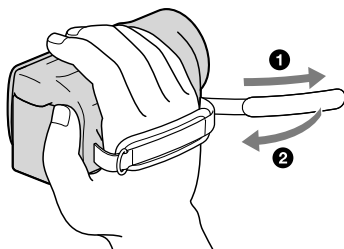

2 Open the LCD screen of your camcorder.

Your camcorder is turned on.

- To turn on your camcorder when the LCD screen is already open, press POWER (p. 15).
- You can switch recording modes by pressing MODE. Press MODE to light up the desired recording mode lamp.

HDR-CX110E/CX115E/CX116E/CX150E/CX155E

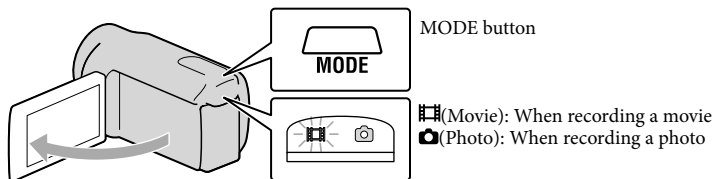

HDR-XR150E/XR155E

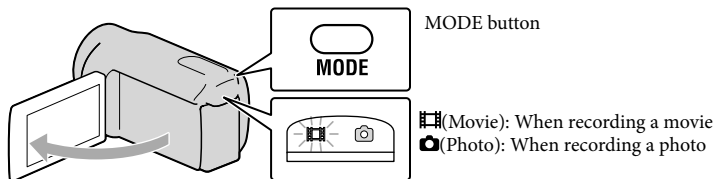

Recording movies

Press START/STOP to start recording.

- You can start recording also by touching ● in the bottom left of LCD screen.

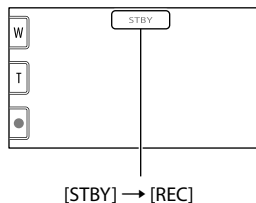
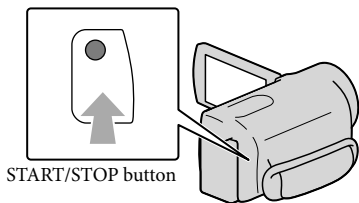

To stop recording, press START/STOP again.

- You can stop recording also by touching ● in the bottom left of LCD screen.

- The icons and indicators on the LCD panel will be displayed for about 3 seconds, then disappear after turning on your camcorder or switching the recording (movie/photo)/playback modes. To display the icons and indicators again, touch anywhere on the screen except the rec & zoom buttons on the LCD.

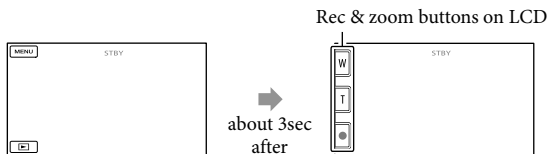

⚡ Notes

- If you close the LCD screen while recording movies, the camcorder stops recording.
- The maximum continuous recordable time of movies is about 13 hours.
- When a movie file exceeds 2 GB, the next movie file is created automatically.
- It will take several seconds until you can start recording after you turn on the camcorder. You cannot operate your camcorder during this time.

- The following states will be indicated if data is still being written onto the recording media after recording has finished. During this time, do not apply shock or vibration to the camcorder, or remove the battery or AC Adaptor.
 - Access lamp (p. 19) is lit or flashing
 - The media icon in the upper right of the LCD screen is flashing

Tips

- See page 68 on the recordable time of movies.
- You can record photos during movie recording by pressing PHOTO fully (Dual Rec).
- When a face is detected, a white frame appears and the image quality around the face is optimized automatically ([FACE DETECTION]).
- You can specify the priority face by touching it.
- In the default setting, a photo is recorded automatically when the camcorder detects the smile of a person during movie recording (Smile Shutter).
- You can capture photos from recorded movies (HDR-CX110E/CX116E/CX150E/CX155E/XR150E/XR155E).
- You can check the recordable time, estimated remaining capacity, etc., by touching **MENU** (MENU) → [Show others] → [MEDIA INFO] (under  [MANAGE MEDIA] category).
- The LCD screen of your camcorder can display recording images across the entire screen (full pixel display). However, this may cause slight trimming of the top, bottom, right and left edges of images when played back on a TV which is not compatible with full pixel display. In this case, set [GUIDEFRAAME] to [ON], and record images using the outer frame displayed on the screen as a guide.
- To adjust the angle of the LCD panel, first open the LCD panel 90 degrees to the camcorder (①), and then adjust the angle (②).

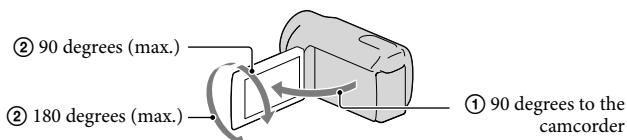



- [ STEADYSHOT] is set to [ACTIVE] in the default setting.

Data code during recording

The recording date, time and condition are recorded automatically on the recording media.

They are not displayed during recording. However, you can check them as [DATA CODE] during playback. To display them, touch **MENU** (MENU) → [Show others] → [PLAYBACK

SET] (under  [PLAYBACK] category) → [DATA CODE] → a desired setting → **OK** →  → .

Shooting photos

In the default setting, photos are recorded on the following recording media.

HDR-CX110E/CX115E: Memory card

HDR-CX116E/CX150E/CX155E: Internal memory

HDR-XR150E/XR155E: Internal hard disk

Tips

- To change the recording media, see page 17 (HDR-CX116E/CX150E/CX155E/XR150E/XR155E).

1 Press MODE to turn on the (Photo) lamp.

The LCD screen display switches for photo recording mode, and the screen aspect ratio becomes 4:3.





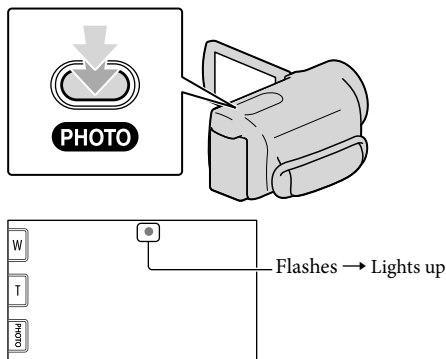

2 Press PHOTO lightly to adjust the focus, then press it fully.

- You can record photos also by touching  on the LCD screen.



When  disappears, the photo is recorded.

Tips

- You can check the recordable number of photos on the LCD (p. 71).
- To change the image size, touch  (MENU) → [Show others] → [ IMAGE SIZE] (under  [PHOTO SETTINGS] category) → a desired setting →  → .
- You cannot record photos while  is displayed.

Playback on the camcorder

In the default setting, movies and photos that are recorded on the following recording media are played.

HDR-CX110E/CX115E: Memory card

HDR-CX116E/CX150E/CX155E: Internal memory

HDR-XR150E/XR155E: Internal hard disk

Tips

- To change the recording media, see page 17 (HDR-CX116E/CX150E/CX155E/XR150E/XR155E).

1 Open the LCD screen of your camcorder.

Your camcorder is turned on.

- To turn on your camcorder when the LCD screen is already open, press POWER (p.15).

2 Press (VIEW IMAGES).

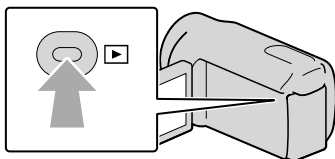

The VISUAL INDEX screen appears after some seconds.

- You can display the VISUAL INDEX screen also by touching  (VIEW IMAGES) on the LCD screen.

3 Touch **HDR** or **HSTDH** (①) → a desired movie (②) to playback a movie. Touch the (Photo) (①) → a desired photo (②) to view a photo.

Movies are displayed and sorted by recording date.

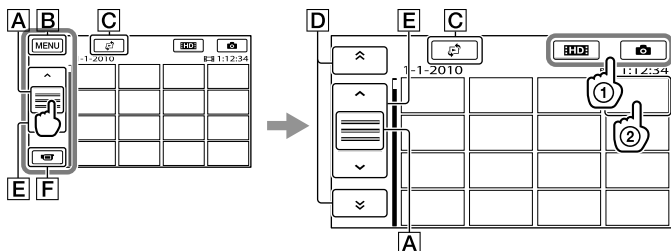

- A** Switches operating button display.
- B** To MENU screen

C Displays the screen to select the index type ([DATE INDEX]/[FILM ROLL]/[FACE]).

D / : Displays movies recorded on the previous/next date.*

E / : Displays the previous/next movie.

F Returns to the recording screen.

* **D** is displayed when **A** is touched.

- **HSTD** appears when the standard definition image quality (STD) movie is selected with [**H/D**]/**SET**.
- You can scroll the display by touching and dragging **D** or **E**.
- appears with the movie or photo that was most recently played or recorded. If you touch the movie or photo with , you can continue playback from the previous time. (appears on the photo recorded on the memory card.)

Playing movies

Your camcorder starts playing the selected movie.

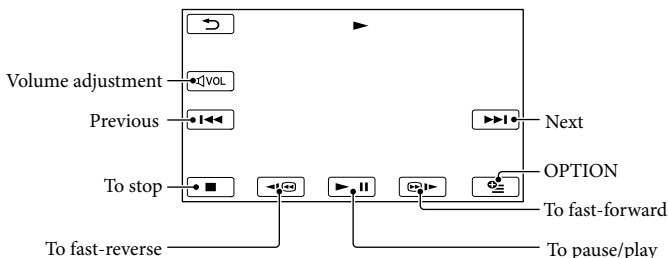

Notes

- You may not be able to play back the images with other devices than camcorder.

Tips

- When playback from the selected movie reaches the last movie, the screen returns to the INDEX screen.
- Touch / during pause to play back movies slowly.
- As you repeat touching / during playback, movies are played as fast as about 5 times → about 10 times → about 30 times → about 60 times.
- You can also display the VISUAL INDEX by touching **MENU** (MENU) → [Show others] → [VISUAL INDEX] (under [PLAYBACK] category).
- The recording date, time, and shooting conditions are recorded automatically during recording. This information is not displayed during recording, but you can display it during playback by touching **MENU** (MENU) → [Show others] → [PLAYBACK SET] (under [PLAYBACK] category) → [DATA CODE] → a desired setting → **OK** → → **X**.

To adjust the sound volume of movies

While playing back movies, touch **<VOL>** → adjust with **🔊-** / **🔊+** → **↺**.

- You can also adjust the sound volume by using **-** / **+** in the OPTION MENU.

Viewing photos

Your camcorder displays the selected photo.

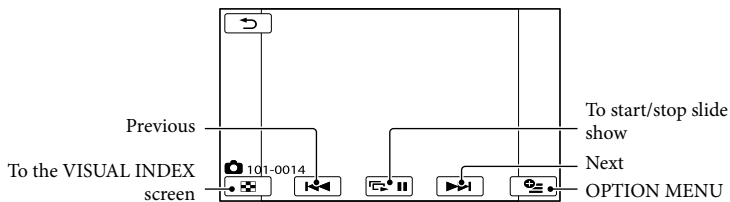

Tips

- When viewing photos recorded on the memory card, **101** (playback folder) appears on the screen.

Playing images on a TV

Connection methods and the image quality (high definition (HD) or standard definition (STD)) viewed on the TV screen differ depending on what type of TV is connected, and the connectors used.

Connecting a TV using [TV CONNECT Guide]

You can connect your camcorder to the TV easily following the instructions displayed on the LCD screen, [TV CONNECT Guide].

1 Switch the input on the TV to the connected jack.

- Refer to the instruction manuals of the TV.

2 Turn on your camcorder, and touch **MENU** (MENU) → [Show others] → [TV CONNECT Guide] (under **[OTHERS]** category) on the LCD screen.

- Use the supplied AC Adaptor as the power source (p. 13).

3 Touch [High Definition TV].

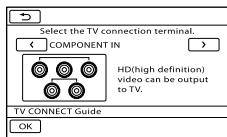

4 Touch **<**/**>** to select the input jack of your TV, then touch **OK**.

- The connection method is displayed.
- If you touch [HINT], you can see tips for the connection or change the settings of your camcorder.

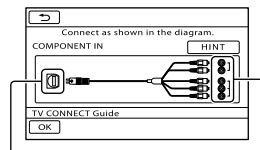

Connectors on your camcorder

Input connectors on the TV

5 Connect your camcorder to the TV.

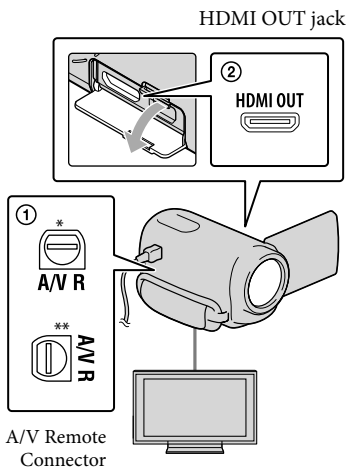

* HDR-CX110E/CX115E/CX116E/CX150E/CX155E

** HDR-XR150E/XR155E

6 Touch **OK** → [YES].

- When the A/V connecting cable is used to output movies, movies are output with standard definition image quality (STD).

7 Play back movies and photos on your camcorder (p. 26).

Types of connection cables between your camcorder and TV

Connecting to a high definition TV

Component A/V Cable (supplied)

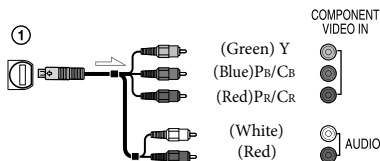

HDMI Cable (sold separately)

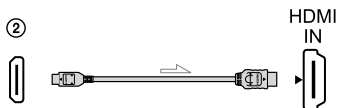

Connecting to a non-high-definition 16:9 (wide) or 4:3 TV

Component A/V Cable (supplied)

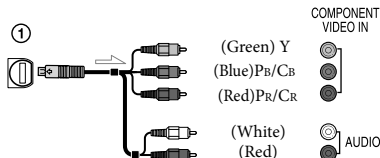

A/V connecting cable with S VIDEO (sold separately)

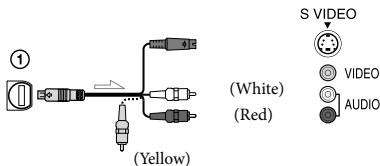

A/V connecting cable (supplied)

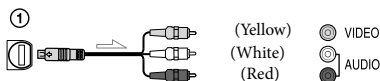

When connecting to your TV via a VCR

- Connect your camcorder to the LINE IN input on the VCR using the A/V connecting cable. Set the input selector on the VCR to LINE (VIDEO 1, VIDEO 2, etc.).

To set the aspect ratio according to the connected TV (16:9/4:3)

- Set [TV TYPE] to [16:9] or [4:3] according to your TV.

When your TV is monaural (When your TV has only one audio input jack)

- Connect the yellow plug of the A/V connecting cable to the video input jack and connect the white (left channel) or red (right channel) plug to the audio input jack of your TV or VCR.

When you connect with component A/V cable

- If you connect only component video plugs, audio signals are not output. Connect the white and red plugs to output audio signals.



When you connect with HDMI cable

- Use an HDMI cable with the HDMI logo.
- Use an HDMI mini connector on one end (for the camcorder), and a plug suitable for connecting your TV on the other end.
- Copyright-protected images are not output from the HDMI OUT jack of your camcorder.
- Some TVs may not function correctly (e.g., no sound or image) with this connection.
- Do not connect the camcorder HDMI OUT jack to an external device HDMI OUT jack, as malfunction may result.

When you connect with A/V connecting cable with S VIDEO

- When the S VIDEO plug (S VIDEO channel) is connected, audio signals are not output. To output audio signals, connect the white and red plugs to the audio input jack of your TV.
- This connection produces higher resolution images compared with the A/V connecting cable.

⚡ Notes

- When you play back standard definition image quality (STD) movies on a 4:3 TV that is not compatible with the 16:9 signal, record movies with 4:3 aspect ratio. Touch **MENU** (MENU) → [Show others] → [OTHER REC SET] (under  [SHOOTING SET] category) → [WIDE SELECT] → [4:3] → **OK** →  →  (p. 57).

If your TV/VCR has a 21-pin adaptor (EUROCONNECTOR)

Use a 21-pin adaptor (sold separately) to view playback pictures.



💡 Tips

- If you connect your camcorder to the TV using more than one type of cable to output images, the order of priority of the TV input jacks is as follows:
HDMI → component → S VIDEO → video

- HDMI (High Definition Multimedia Interface) is an interface to send both video/audio signals. The HDMI OUT jack outputs high quality images and digital audio.

On “Photo TV HD”

This camcorder is compatible with the “Photo TV HD” standard. “Photo TV HD” allows for highly-detailed, photo-like depiction of subtle textures and colors. By connecting Sony’s Photo TV HD-compatible devices using an HDMI cable* or the component A/V cable**, a whole new world of photos can be enjoyed in breathtaking full HD quality.

- * The TV will automatically switch to the appropriate mode when displaying photos.
- ** Setup of the TV will be necessary. Please refer to the instructions of your Photo TV HD-compatible TV for details.

Deleting movies and photos

You can free media space by deleting movies and photos from recording media.

Notes

- You cannot restore images once they are deleted. Save important movies and photos in advance.
- Do not remove the battery pack or the AC Adaptor from your camcorder while deleting the images. It may damage the recording media.
- Do not eject memory card while deleting images from the memory card.
- You cannot delete protected movies and photos. Undo the protection of the movies and photos to delete them, before you try to delete them.
- If the deleted movie is included in the Playlist, the movie added to the Playlist is deleted also from the Playlist.
- If the deleted movie is included in the saved Highlight Playback scenario, the movie is also deleted from the scenario.

Tips

- You can delete an image on the playback screen from **OPTION MENU**.
- To delete all images recorded in the recording media, and recover all the recordable space of the media, format the media.
- Reduced-size images which enable you to view many images at the same time on an index screen are called “thumbnails.”

1 Touch **MENU** (MENU) → [Show others] → [DELETE] (under **[EDIT]** category).

2 To delete movies, touch **[DELETE]** → **[HDD] DELETE** or **[STD] DELETE**.

- To delete photos, touch **[DELETE]** → **[DELETE]**.

3 Touch and display the ✓ mark on the movies or photos to be deleted.

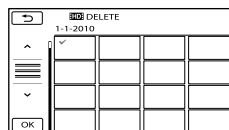

- Press and hold the image down on the LCD screen to confirm the image. Touch **[RETURN]** to return to the previous screen.

4 Touch **OK** → [YES] → **OK** → **X**.

To delete all movies/photos at one time



In step 2, touch **[DELETE]** → **[HDD] DELETE ALL** / **[STD] DELETE ALL** → [YES] → [YES] → **OK** → **X**.

- To delete all photos at one time, touch **[DELETE]** → **[DELETE ALL]** → [YES] → [YES] → **OK** → **X**.

To delete all the movies/photos recorded on the same day at one time



⚡ Notes

- You cannot delete photos on memory card by recording date.

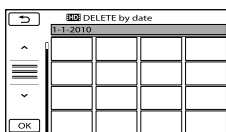

① In step 2, touch [ DELETE] → [ DELETE by date] / [ DELETE by date].

- To delete all photos on the same day at one time, touch [ DELETE] → [ DELETE by date].



② Touch  /  to select the recording date of the desired movies/photos, then touch .

- Touch the image on the LCD screen to confirm the image. Touch  to return to the previous screen.

③ Touch [YES] →  → .

Preparing a computer

(Windows)

You can perform following operations using “PMB (Picture Motion Browser).”

- Importing images to a computer
- Viewing and editing imported images
- Creating a disc
- Uploading movies and photos to websites

To save movies and photos using a computer, install “PMB” from the supplied CD-ROM beforehand.

Notes

- Do not format the media of your camcorder from a computer. Your camcorder may not operate correctly.
- This camcorder captures high definition footage in the AVCHD format. Using the enclosed PC software, high definition footage can be copied onto DVD media. However, DVD media containing AVCHD footage should not be used with DVD based players or recorders, as the DVD player/recorder may fail to eject the media and may erase its contents without warning.

Step 1 Checking the computer system

OS*1

Microsoft Windows XP SP3*2/Windows Vista SP2*3/Windows 7

CPU*4
Intel Core Duo 1.66 GHz or faster, or Intel Core 2 Duo 1.66 GHz or faster (Intel Core 2 Duo 2.26 GHz or faster is required when processing HD FX/HD FH movies) However, Intel Pentium III 1 GHz or faster is sufficient for the following operations: – Importing the movies and photos to the computer – One Touch Disc Burn – Creating a Blu-ray disc/AVCHD disc/DVD-video (Intel Core Duo 1.66 GHz or faster is required when creating a DVD video by converting high definition image quality (HD) to standard definition image quality (STD).) – Copying a disc – Processing only the movies with standard definition image quality (STD)
Application
DirectX 9.0c or later (This product is based on DirectX technology. It is necessary to have DirectX installed.)
Memory
For Windows XP: 512 MB or more (1 GB or more is recommended.) However, 256 MB or more is sufficient for processing only the movies with standard definition image quality (STD). For Windows Vista/Windows 7: 1 GB or more
Hard disk
Disk volume required for installation: Approximately 500 MB (10 GB or more may be necessary when creating AVCHD discs. 50 GB maximum may be necessary when creating Blu-ray discs.)
Display
Minimum 1,024 × 768 dots
Others
USB port (this must be provided as standard, Hi-Speed USB (USB 2.0 compatible)), Blu-ray disc/DVD burner (CD-ROM drive is necessary for installation) Either NTFS or exFAT file system is recommended as the hard disk file system.

*1 Standard installation is required. Operation is not assured if the OS has been upgraded or in a multi-boot environment.

*2 64-bit editions and Starter (Edition) are not supported. Windows Image Mastering API (IMAPI) Ver.2.0 or newer is required to use disc creation function, etc.

*3 Starter (Edition) is not supported.

*4 Faster processor is recommended.

Notes

- Operation with all computer environments is not assured.

When using a Macintosh

The supplied software “PMB” is not supported by Macintosh computers. To import the movies and photos to the computer, please contact Apple Inc.

Step 2 Installing the supplied software “PMB”

Install “PMB” before connecting your camcorder to a computer.

Notes

- If a version of “PMB” under 5.0.00 has been installed on your computer, you may be unable to use some functions of those “PMB” when installing the “PMB” from the supplied CD-ROM. Also, “PMB Launcher” is installed from the supplied CD-ROM and you can start “PMB” or other software by using the “PMB Launcher.” Double-click the “PMB Launcher” short-cut icon on the computer screen to start “PMB Launcher.”

1 Confirm that your camcorder is not connected to the computer.

2 Turn on the computer.

- Log on as an Administrator for installation.
- Close all applications running on the computer before installing the software.

3 Place the supplied CD-ROM in the disc drive of your computer.

The installation screen appears.

- If the screen does not appear, click [Start] → [Computer] (in Windows XP, [My Computer]), then double-click [SONYPMB (E:)] (CD-ROM)*.



* Drive names (such as (E:)) may vary depending on the computer.

4 Click [Install].



5 Select the country or region.

6 Select the language for the application to be installed, then proceed to the next screen.

7 Read the terms of the license agreement carefully. If you agree to the terms, change  to , and then click [Next] → [Install].

-
- 8** Turn on your camcorder, then connect the camcorder to the computer using the supplied USB cable.

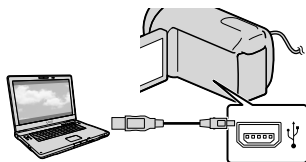

The [USB SELECT] screen appears on the camcorder screen automatically.

-
- 9** Touch the one of the media types displayed on the camcorder screen to make the computer recognize your camcorder.

HDR-CX110E/CX115E: [USB CONNECT] (memory card)

HDR-CX116E/CX150E/CX155E : [USB CONNECT] (internal memory)

HDR-XR150E/XR155E: [USB CONNECT] (internal hard disk)

- The displayed recording media differ depending on the model.
- If the [USB SELECT] screen does not appear, touch **MENU** (MENU) → [Show others] → [USB CONNECT] (under [OTHERS] category).

-
- 10** Click [Continue] on the computer screen.

-
- 11** Follow the on-screen instructions to install the software.

- Connect the camcorder to the computer during the installation of “PMB.”

- Depending on the computer, you may need to install third party software. If the installation screen appears, follow the instructions to install the required software.
- Restart the computer if required to complete the installation.

When the installation is completed, following icons will appear.

Remove the CD-ROM from your computer.



: Starts “PMB.”

: Displays “PMB Help.”

: Displays “PMB Launcher.”

“PMB Launcher” enables you to start “PMB” or other software, or to open web sites.

- Other icons may appear.
- No icon may appear depending on the installation procedure.

Notes

- To create discs or use other functions on Windows XP, Image Mastering API v2.0 for Windows XP should be installed. If Image Mastering API v2.0 for Windows XP has not been installed yet, select it from required programs on the installation screen and install it following the procedures displayed. (The computer must be connected to the internet for the installation.) You may install Image Mastering API v2.0 for Windows XP in response to the message displayed when you try to start those functions.

Starting PMB (Picture Motion Browser)

To disconnect your camcorder from the computer

- 1 Click the  icon at the bottom right of the desktop of the computer → [Safely remove USB Mass Storage Device].



- 2 Touch [END] → [YES] on the camcorder screen.
- 3 Disconnect the USB cable.

Notes

- Access from the computer using the supplied software “PMB.” Do not modify the files or folders on the camcorder from the computer. The image files may be destroyed or may not be played back.
- When importing images recorded for long time or edited, use the supplied software “PMB.” If you do not use “PMB,” you cannot import images correctly.
- Operation is not guaranteed, if you perform the above operation.
- When you delete image files, follow the steps on page 32. Do not delete the image files on the camcorder directly from the computer.
- Do not copy the files on the recording media from the computer. Operation is not guaranteed.
- You can create a Blu-ray disc by using a computer with a Blu-ray disc burner. Install the BD Add-on Software for “PMB”(p. 43).

Double-click the “PMB” short-cut icon on the computer screen.



Notes

- If the icon is not displayed on the computer screen, click [Start] → [All Programs] →  [PMB] to start “PMB.”

You can view, edit, or create discs of movies and photos using “PMB.”

Reading “PMB Help”

For details on how to use “PMB,” read the “PMB Help.” Double-click the “PMB Help” short-cut icon on the computer screen to open the “PMB Help.”

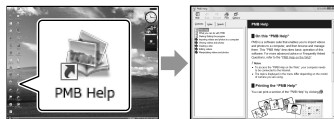







Notes

- If the icon is not displayed on the computer screen, click [Start] → [All Programs] → [PMB] → [PMB Help]. You can also open the “PMB Help” from [Help] of “PMB.”

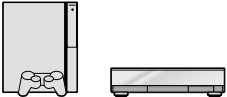
Selecting the method for creating a disc (computer)

Several methods for creating a high definition image quality (HD) disc or a standard definition image quality (STD) disc from high definition image quality (HD) movies or photos recorded on your camcorder are described here. Select the method that suits your disc player.

Player	Choosing a method and disc type	
Blu-ray disc playback devices (a Blu-ray disc player, PlayStation®3, etc.)	① Importing movies and photos to a computer (p. 41) ↓ ② Creating a Blu-ray disc* with high definition image quality (HD) (p. 43)	 Blu-ray
AVCHD format playback devices (a Sony Blu-ray disc player, PlayStation®3, etc.)	Creating a disc with one touch (One Touch Disc Burn) (p. 40)	 AVCHD
	① Importing movies and photos to a computer (p. 41) ↓ ② Creating an AVCHD format disc with high definition image quality (HD) (p. 42)	 AVCHD
Ordinary DVD playback devices (a DVD player, a computer that can play DVDs, etc.) 	① Importing movies and photos to a computer (p. 41) ↓ ② Creating a standard definition image quality (STD) disc (p. 43)	 STD

* To create a Blu-ray disc, the BD Add-on Software for “PMB” must be installed (p. 43).

Characteristics of each type of disc

 Using a Blu-ray disc enables you to record high definition image quality (HD) movies of a longer duration than DVD discs.

 High definition image quality (HD) movie can be recorded on DVD media, such as DVD-R discs, and a high definition image quality (HD) disc is created.

You can play a high definition image quality (HD) disc on AVCHD format playback devices, such as a Sony Blu-ray disc player and a PlayStation®3. You cannot play the disc on ordinary DVD players.

 Standard definition image quality (STD) movie converted from high definition image quality (HD) movie can be recorded on DVD media, such as DVD-R discs, and a standard image quality (STD) disc is created.

Discs you can use with “PMB”

You can use 12 cm discs of following type with “PMB.” For Blu-ray disc, see page 43.

Disc type	Features
DVD-R/DVD+R/DVD+R DL	Unrewritable
DVD-RW/DVD+RW	Rewritable

Notes

- Always maintain your PlayStation®3 to use the latest version of the PlayStation®3 system software.
- The PlayStation®3 may not be available in some countries/regions.

Creating a disc with one touch

(One Touch Disc Burn)

Movies and photos recorded on your camcorder that have not yet been saved with One Touch Disc Burn function can be saved on a disc automatically. Movies and photos are saved on a disc with their recorded image quality.

⚡ Notes

- High definition image quality (HD) movies (the default setting) will make an AVCHD disc.
- You cannot create AVCHD discs from movies recorded with [HD FX] mode of [RECORD MODE].
- Creating a Blu-ray disc is not available with One Touch Disc Burn.
- To create a standard definition image quality (STD) disc from high definition image quality (HD) movies, import movies to a computer first (p. 41), and then create a standard definition image quality (STD) disc (p. 43).
- Install “PMB” beforehand (p. 35), however, do not start “PMB.”
- Connect your camcorder to the wall outlet (wall socket) using the AC Adaptor supplied for this operation (p. 13).
- With One Touch Disc Burn function on your camcorder, you can save movies and photos recorded on the internal recording media only (HDR-CX116E/CX150E/CX155E/XR150E/XR155E).

1 Turn on your computer, and place an unused disc on the DVD drive.

- See page 39 for the type of discs you can use.
- If any other software than “PMB” starts automatically, shut it down.

2 Turn on your camcorder, then connect the camcorder to the computer using the supplied USB cable.

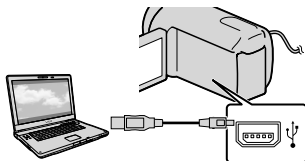

3 Press  (DISC BURN).

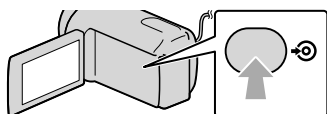

4 Follow the instructions on the computer screen.

⚡ Notes

- Movies and photos are not saved on the computer when you perform One Touch Disc Burn.

Importing movies and photos to a computer

Movies and photos recorded on your camcorder can be imported to a computer. Turn on the computer beforehand.

Notes

- Connect your camcorder to the wall outlet (wall socket) using the supplied AC Adaptor for this operation (p. 13).

- 1 Turn on your camcorder, then connect the camcorder to the computer using the supplied USB cable.

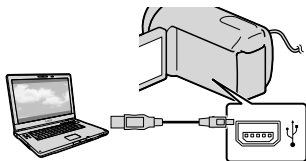

The [USB SELECT] screen appears on the camcorder screen.

- 2 Touch the recording media that contains the images you want to save on the camcorder screen.

[ USB CONNECT]: Internal memory

[ USB CONNECT]: Internal hard disk

[ USB CONNECT]: Memory card

- The displayed recording media differ depending on the model.
- If the [USB SELECT] screen does not appear, touch **MENU** (MENU) → [Show others] → [USB CONNECT] (under  [OTHERS] category).

The window for import appears on the computer screen.

- 3 Click [Import].

- Refer to “PMB Help” (p. 37) for details.



Movies and photos are imported to your computer.

When the operation is completed, the “PMB” screen appears.

Tips

- You can export high definition image quality (HD) movies from your computer to your camcorder (HDR-CX110E/CX150E/XR150E). See “PMB Help” (p. 37) for details.

Creating an AVCHD disc

You can create an AVCHD disc by putting together high definition image quality (HD) movies previously imported to your computer (p. 41).

In this section, the procedure for recording a high definition image quality (HD) movie on a DVD disc is explained.

1 Turn on your computer, and place an unused disc on the DVD drive.

- See page 38 for the type of discs you can use.
- If any other software than “PMB” starts automatically, shut it down.

2 Start “PMB” (p. 37).

3 Click [Calendar] or [Index] on the left side in the window, and select the date or folder, then select the high definition image quality (HD) movies.

- High definition image quality (HD) movies are marked with **HD**.
- You cannot save photos on a disc.
- To select plural movies, hold the Ctrl key down and click thumbnails.

4 At the top of the window, click  → [Create AVCHD Format Discs (HD)].



The window used to select movies appears.

- To add movies to the previously selected ones, select the movies in the main window and drag and drop onto the window for selecting movies.

5 Follow the instructions on the screen to create a disc.

- It may take a long time to create a disc.

Playing an AVCHD disc on a computer

You can play back AVCHD discs using “Player for AVCHD” that is installed together with “PMB.”

To start “Player for AVCHD” Click [Start] → [All Programs] → [PMB] → [PMB Launcher] → [View] → [Player for AVCHD].

See the “Player for AVCHD” help on the operation.

- Movies may not be played smoothly depending on the computer environment.

Creating a Blu-ray disc

You can create a Blu-ray disc with a high definition image quality (HD) movie previously imported to a computer (p. 41).

To create a Blu-ray disc, the BD Add-on Software for “PMB” must be installed. Click [BD Add-on Software] on the installation screen of “PMB,” and install this plug-in according to the on-screen instructions.

- Connect your computer to the internet when you install [BD Add-on Software].



Place an unused Blu-ray disc in the disc drive, and click  → [Create Blu-ray Disc (HD)] in step 4 of “Creating an AVCHD disc” (p. 42). Other procedures are the same as that for creating an AVCHD disc.

- Your computer must support the creation of Blu-ray discs.
- BD-R (unrewritable) and BD-RE (rewritable) media are available for creating Blu-ray discs. You cannot add contents to either type of disc after creating the disc.

Creating a standard definition image quality (STD) disc that can be played on ordinary DVD players

You can create a standard definition image quality (STD) disc by selecting movies previously imported to your computer (p. 41).

④ Notes

- You may select high definition image quality (HD) movies as sources. However, image quality is converted from high definition (HD) to standard definition (STD). It will take a longer time for converting the image quality of the movies than it took to actually record the movies.

1 Turn on your computer, and place an unused disc on the DVD drive.

- See page 38 for the type of discs you can use.
- If any other software than “PMB” starts automatically, shut it down.

2 Start “PMB” (p. 37).

3 Click [Calendar] or [Index] on the left side in the window, and select the date or folder, then select the movies.

- High definition image quality (HD) movies are marked with **HD**.
- To select plural movies, hold the Ctrl key down and click thumbnails.

-
- 4 At the top of the window, click  → [Create DVD-Video Format Discs (STD)].

The window used to select movies appears.

- To add movies to the previously selected ones, select the movies in the main window and drag and drop onto the window for selecting movies.



-
- 5 Follow the instructions on the screen to create a disc.

- It may take a long time to create a disc.

Copying a disc

You can copy a recorded disc to another disc using “Video Disc Copier.”

Click [Start] → [All Programs] → [PMB] → [PMB Launcher] → [Disc Creation] → [Video Disc Copier] to start the software. See “Video Disc Copier” help on the operation.

- You cannot copy high definition image quality (HD) movies by converting them to standard definition image quality (STD).
- You cannot copy to a Blu-ray disc.

Editing movies

You can cut out only necessary parts from a movie and save it as another file. Double-click the movie to be edited on “PMB,” then click [Show Edit Palette] on the right side of the screen → [Trim Video], or select the [Manipulate] menu → [Edit] → [Trim Video]. See “PMB Help” (p. 37) for details.

Capturing photos from a movie

You can save a frame of a movie as a photo file.

Double-click the movie to be edited on “PMB,” then click [Show Edit Palette] on the right side of the screen → [Save Frame]. See “PMB Help” (p. 37) for details.



Saving images in external media

(DIRECT COPY)

You can save movies and photos on external media (USB storage device), such as an external hard disk drive. You can also play back images on the camcorder or another playback device.

Notes

- For this operation, you need the USB Adaptor Cable VMC-UAM1 (sold separately).
- The USB Adaptor Cable VMC-UAM1 may not be available in some countries/regions.
- You cannot use the following devices as an external media.
 - media with a capacity exceeding 2 TB
 - ordinary disc drive such as CD or DVD drive
 - media connected via USB hub
 - media with built-in USB hub
 - card reader
- You may not be able to use external media with a code function.
- FAT file system is available for your camcorder. If the external media was formatted to NTFS file system, etc., format the external media on your camcorder before use. The format screen appears when the external media is connected to your camcorder. However, the format screen may appear even if you use the external media of FAT file system.
- Operation is not assured with every device satisfying requirements for operating.
- Connect your camcorder to the wall outlet (wall socket) using the supplied AC adaptor (p. 13).
- Refer to the instruction manual supplied with the external media.
- For details on available external media, go to the Sony support website in your country/region.

Tips

- You can import images saved in the external media by using the supplied software “PMB.”

1 Connect the AC Adaptor and the power cord (mains lead) to the DC IN jack of your camcorder and the wall outlet (wall socket).

2 If the external media has the AC power cable, connect it to the wall outlet (wall socket).

3 Connect the USB Adaptor Cable to the external media.

4 Connect the USB Adaptor Cable to the Ψ (USB) jack of your camcorder.

When the [Create a new Image Database File.] screen appears, touch [YES].

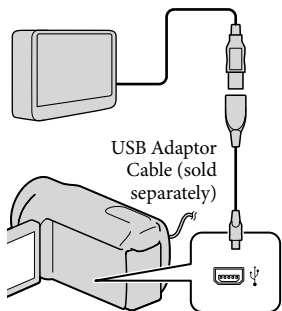

5 Touch [Copy.] on the camcorder screen.

HDR-CX110E/CX115E:

Movies and photos that have not yet been saved on to external media can be saved.

HDR-CX116E/CX150E/CX155E/
XR150E/XR155E:

Movies and photos in the internal recording media of the camcorder that have not yet been saved on to external media can be saved.

- This screen will appear only when there are newly recorded images.

6 After the operation is completed, touch **OK** on the camcorder screen.

Notes

- The number of scenes you can save on the external media are as follows. However, even if the external media has free space, you cannot save scenes exceeding the following number.
High definition image quality (HD) movies: Max. 3,999
Standard definition image quality (STD) movies: 9,999
Photos: 9,999 frames × 899 folders
The number of scenes may be smaller depending on the type of images recorded.

When connecting an external media

The images saved in the external media are displayed on the LCD screen. The movie display and photo display buttons on the VISUAL INDEX screen change as illustrated below.

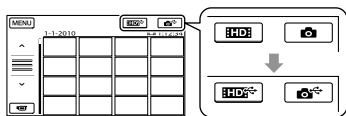

You can make menu settings of the external media such as deleting images. Touch **MENU** (MENU) → [Show others] on the VISUAL INDEX screen.

To save desired movies and photos

You can save images from the memory cards to the external media.

Notes

- You cannot copy or search photos by date which are recorded on the memory card.

1 Touch [Play without copying.] in step 5 above.

The VISUAL INDEX screen of the external media is displayed.

2 Touch **MENU** (MENU) → [Show others] → [MOVIE DUB] (when selecting movies)/[PHOTO COPY] (when selecting photos).

3 Follow the on-screen instructions to select the recording media (HDR-CX116E/CX150E/CX155E/XR150E/XR155E) and image selection methods.

4 When you selected [DUB by select], touch the image to be saved.

✓ appears.

- When you selected [DUB by date], select the date of the images to be dubbed with **^** / **v**, then touch **OK** and go to step 5.

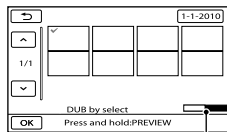

Remaining external media capacity

- Press and hold the image down on the LCD screen to confirm the image. Touch **↶** to return to the previous screen.
- By touching date, you can search for images by date.

5 Touch **OK** → [YES] → **OK** on the camcorder screen.

Creating a disc with a DVD writer, recorder

To play back images in the external media on the camcorder

- ① Touch [Play without copying.] in step 5 above.

The VISUAL INDEX screen of the external media is displayed.

- ② Play back the image (p. 26).
 - You can also view images on a TV connected to your camcorder (p. 29).
 - You can play back the high definition image quality (HD) movies on your computer using [Player for AVCHD]. Start [Player for AVCHD] (p. 42), and select the drive where the external media is connected with [Settings].

⚡ Notes

- The Date Index of photos cannot be displayed.
- If your camcorder does not recognize the external media, try the following operations.
 - Reconnect the USB Adaptor Cable to your camcorder
 - If the external media has the AC power cable, connect it to the wall outlet (wall socket)

To finish the external media connection

- ① Touch  on the VISUAL INDEX screen of the external media.
- ② Disconnect the USB Adaptor Cable.

Selecting the method for creating a disc

Several methods for creating an AVCHD disc or a standard definition image quality (STD) disc from high definition image quality (HD) movies or photos recorded on your camcorder are described here. Select the method that suits your disc player.

⚡ Notes

- Prepare a DVD disc such as a DVD-R, for creating a disc.
- See page 43 to create a Blu-ray disc.
- See page 45 to save images in the external media.

AVCHD format compatible device

Player

- Sony Blu-ray disc player
- PlayStation®3, etc.

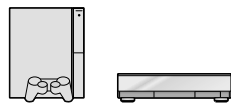

Creating device

- DVD writer, DVDDirect Express (p. 48)
- DVD writer, etc., other than DVDDirect Express (p. 51)

Disc type

- AVCHD disc (high definition image quality (HD))



Ordinary DVD device

Player

- DVD player
- Computer that can play DVDs, etc.

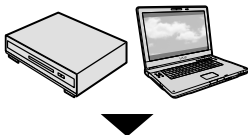

Creating device

- DVD writer, DVDirect Express (p. 48)
- DVD writer, other than DVDirect Express (p. 51)
- Disc recorder, etc. (p. 52)

Disc type

- Standard definition image quality (STD) disc



⚡ Notes

- Always maintain your PlayStation®3 to use the latest version of the PlayStation®3 system software.
- The PlayStation®3 may not be available in some countries/regions.
- The AVCHD disc can be played back only on AVCHD format compatible devices.
- The AVCHD disc should not be used in DVD players/recorders. Because DVD players/recorders are not compatible with the AVCHD format, DVD players/recorders may fail to eject the disc.
- You cannot create an AVCHD disc from a movie recorded with [HD FX] mode of [RECORD MODE]. Save a movie recorded with [HD FX] mode onto Blu-ray discs or external storage devices (p. 45).

Creating a disc with the dedicated DVD writer, DVDirect Express

You can create a disc or play back the images on a created disc by using the dedicated DVD writer, DVDirect Express (sold separately).

Refer also to the instruction manual supplied with the DVD writer.

⚡ Notes

- Connect your camcorder to the wall outlet (wall socket) using the supplied AC Adaptor for this operation (p. 13).
- Only unused discs of the following types can be used:
 - 12cm DVD-R
 - 12cm DVD+R
- The device does not support two-layered discs.
- DVDirect Express is referred to as “DVD writer” in this section.

1 Connect the AC Adaptor and the power cord (mains lead) to the DC IN jack of your camcorder and the wall outlet (wall socket) (p. 13).

2 Turn on your camcorder, and connect the DVD writer to the ⚡ (USB) jack of your camcorder with the USB cable of the DVD writer.

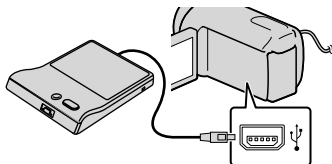

- 3** Insert an unused disc into the DVD writer, and close the disc tray.

The [DISC BURN] screen appears on the camcorder screen.

- 4** Press **DISC BURN** on the DVD writer.

Movies that have not been saved on any discs will be recorded onto the disc (HDR-CX110E/CX115E).

Movies recorded on the internal recording media that have not been saved on any discs will be recorded onto the disc (HDR-CX116E/CX150E/CX155E/XR150E/XR155E).

- When there are unsaved high definition (HD) and standard definition (STD) image quality movies, they will be saved on individual discs according to the image quality.

- 5** Repeat steps 3 and 4 when the total memory size of movies to be burnt exceeds that of the disc.

- 6** Touch **OK** → [END] → [EJECT DISC] on the camcorder screen.

Remove the disc after the operation is completed.

- 7** Touch **OK**, then disconnect the USB cable.

To customize a disc with DISC BURN OPTION

Perform this operation in the following cases:

- When dubbing a desired image
- When creating multiple copies of the same disc
- When converting high definition (HD) movies to standard definition (STD) movies, and creating a disc
- When dubbing images in the memory card (HDR-CX116E/CX150E/CX155E/XR150E/XR155E)

- ①** Touch [DISC BURN OPTION] in step 4.

- ②** Select the recording media containing the movie(s) you want to save (HDR-CX116E/CX150E/CX155E/XR150E/XR155E). When you select movies with high definition image quality (HD), the screen to select the image quality of the disc to be created appears on the LCD screen. Select the desired image quality, and touch **OK**.

- The image quality of the disc depends on the recording time of the selected movies when you create a disc converting them from high definition image quality (HD) to standard definition image quality (STD).

- ③** Touch the movie you want to burn on the disc.
✓ appears.

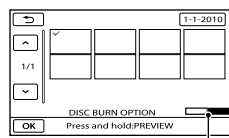

Remaining Disc capacity

- Press and hold the image down on the LCD screen to confirm the image. Touch **DISC BURN** to return to the previous screen.
- By touching date, you can search for images by date.

④ Touch **OK** → [YES] on the camcorder screen.

- To create another disc of the same contents, insert a new disc and touch [CREATE SAME DISC].

⑤ After the operation is completed, touch [EXIT] → [END] on the camcorder screen.

⑥ Disconnect the USB cable from your camcorder.

⚙ Notes

- Do not do any of the following when creating a disc.
 - Turn off the camcorder
 - Disconnect the USB cable or the AC adaptor
 - Subject the camcorder to mechanical shock or vibration
 - Eject the memory card from the camcorder
- Play the created disc to make sure dubbing was performed correctly before deleting the movies on your camcorder.
- If [Failed.] or [DISC BURN failed.] appears on the screen, insert another disc into the DVD writer and perform the DISC BURN operation again.

💡 Tips

- If the total memory size of movies to be burnt by the DISC BURN operation exceeds that of the disc, disc creation stops when the limit is reached. The last movie on the disc may be cut off.
- Disc creation time to dub movies to the limit of the disc is about 20 to 60 minutes. It may take more time depending on the recording mode or the number of scenes. Also, if high definition image quality (HD) is converted to standard definition image quality (STD), image quality conversion takes longer than the actual recording.

To play back a disc on the DVD writer

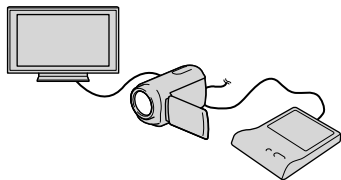

① Connect the AC Adaptor and the power cord (mains lead) to the DC IN jack of your camcorder and the wall outlet (wall socket) (p. 13).

② Turn on your camcorder, and connect the DVD writer to the Ψ (USB) jack of your camcorder with the USB cable of the DVD writer.

- You can play back movies on the TV screen by connecting the camcorder to a TV (p. 29).

③ Insert a created disc into the DVD writer.
The movies on the disc appear as VISUAL INDEX on the camcorder screen.

④ Press the play button on the DVD writer.

- You can also operate by the camcorder screen.

⑤ Touch [END] → [EJECT DISC] on the camcorder screen and remove the disc after the operation is completed.

⑥ Touch **OK** and disconnect the USB cable.

To play back a disc on the ordinary DVD player

Select the standard image quality (STD) on the screen to select the image quality of the disc to be created in step 2 of “To customize a disc with DISC BURN OPTION.”

Tips

- If you cannot play back created standard definition (STD) image quality discs on any DVD player, connect the camcorder to the DVD writer, and then play back.

Creating a high definition image quality (HD) disc with a DVD writer, etc., other than DVDirect Express

Use USB cable to connect your camcorder to a disc creation device, which is compatible with high definition image quality (HD) movies, such as a Sony DVD writer. Refer also to the instruction manuals supplied with the device to be connected.

Notes

- Connect your camcorder to the wall outlet (wall socket) using the supplied AC Adaptor for this operation (p. 13).
- Sony DVD writer may not be available in some countries/regions.

1 Connect the AC Adaptor and the power cord (mains lead) to the DC IN jack of your camcorder and the wall outlet (wall socket) (p. 13).

2 Turn on your camcorder, and connect a DVD writer, etc. to the Ψ (USB) jack of your camcorder with the USB cable (supplied).

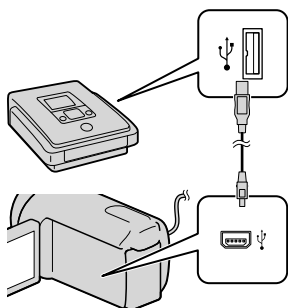

The [USB SELECT] screen appears on the camcorder screen.

- If the [USB SELECT] screen does not appear, touch **MENU** (MENU) → [Show others] → [USB CONNECT] (under  [OTHERS] category).

3 Touch the recording media that contains the images on the camcorder screen.

[ USB CONNECT]: Internal memory

[ USB CONNECT]: Internal hard disk

[ USB CONNECT]: Memory card

- The displayed recording media differ depending on the model.

4 Record movies on the connected device.

- For details, refer to the instruction manuals supplied with the device to be connected.

5 After the operation is completed, touch [END] → [YES] on the camcorder screen.

6 Disconnect the USB cable.

Creating a standard definition image quality (STD) disc with a recorder, etc.

You can dub images played back on your camcorder on a disc or video cassette, by connecting your camcorder to a disc recorder, a Sony DVD writer, etc., other than DVD Direct Express, with the A/V connecting cable. Connect the device in either way of **1** or **2**. Refer also to the instruction manuals supplied with the devices to be connected.

Notes

- Connect your camcorder to the wall outlet (wall socket) using the supplied AC Adaptor for this operation (p. 13).
- Sony DVD writer may not be available in some countries/regions.
- High definition image quality (HD) movies will be dubbed with standard definition image quality (STD).

1 A/V connecting cable (supplied)

Connect the A/V connecting cable to the input jack of another device.

2 A/V connecting cable with S VIDEO (sold separately)

When connecting to another device via the S VIDEO jack, by using an A/V connecting cable with an S VIDEO cable (sold separately), higher quality images can be produced than with an A/V connecting cable. Connect the white and red plug (left/right audio) and the S VIDEO plug (S VIDEO channel) of the A/V connecting cable with an S VIDEO cable. If you connect the S VIDEO plug only, you will hear no sound. The yellow plug (video) connection is not necessary.

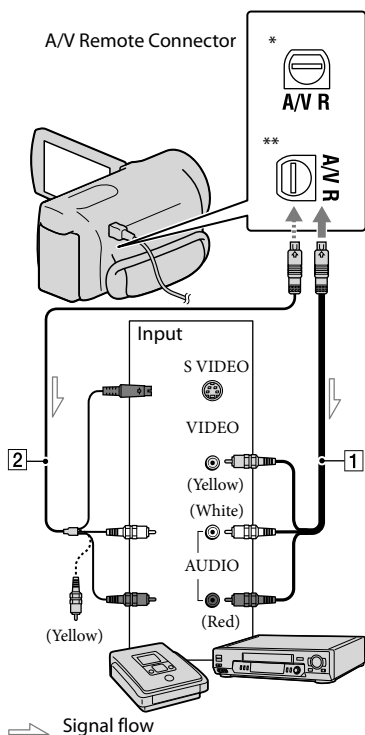

* HDR-CX110E/CX115E/CX116E/CX150E/CX155E

** HDR-XR150E/XR155E

1 Insert the recording media in the recording device.

- If your recording device has an input selector, set it to the input mode.

2 Connect your camcorder to the recording device (a disc recorder, etc.) with the A/V connecting cable **1** (supplied) or an A/V connecting cable with S VIDEO **2** (sold separately).



- Connect your camcorder to the input jacks of the recording device.







3 Start playback on your camcorder, and record it on the recording device.

- Refer to the instruction manuals supplied with your recording device for details.

4 When dubbing is finished, stop the recording device, and then your camcorder.

Notes

- Since dubbing is performed via analog data transfer, the image quality may deteriorate.
- You cannot dub images to recorders connected with an HDMI cable.
- To hide the screen indicators (such as a counter, etc.) on the screen of the monitor device connected, touch **MENU** (MENU) → [Show others] → [OUTPUT SETTINGS] (under  [GENERAL SET] category) → [DISP OUTPUT] → [LCD PANEL] (the default setting) → **OK** →  → **X**.

- To record the date/time or camera settings data, touch **MENU** (MENU) → [Show others] → [PLAYBACK SET] (under  [PLAYBACK] category) → [DATA CODE] → a desired setting → **OK** →  → **X**. In addition, touch **MENU** (MENU) → [Show others] → [OUTPUT SETTINGS] (under  [GENERAL SET] category) → [DISP OUTPUT] → [V-OUT/PANEL] → **OK** →  → **X**.
- When the screen size of display devices (TV, etc.) is 4:3, touch **MENU** (MENU) → [Show others] → [OUTPUT SETTINGS] (under  [GENERAL SET] category) → [TV TYPE] → [4:3] → **OK** →  → **X**.
- When you connect a monaural device, connect the yellow plug of the A/V connecting cable to the video input jack, and the white (left channel) or the red (right channel) plug to the audio input jack on the device.

Using menus

Using the menus, you can perform useful functions and change various settings. If you make good use of menu operations, you can enjoy using your camcorder.

The camcorder has various menu items under each of eight menu categories.

M **MANUAL SETTINGS** (Items to adjust for scene condition) → p. 57

SHOOTING SET (Items for customized shooting) → p. 57

PHOTO SETTINGS (Items for recording photos) → p. 58

PLAYBACK (Items for playback) → p. 58

EDIT (Items for editing) → p. 58

OTHERS (Items for other settings) → p. 59

MANAGE MEDIA (Items for recording media) → p. 59

GENERAL SET (Other setup items) → p. 60

• Menu items are described in more details in the “Handycam” Handbook.

Setting menus

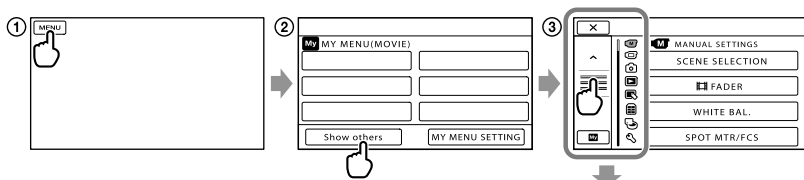

▲ / ▼ : The menu list moves from category to category.

▲ / ▼ : The menu list moves through 4 items at once.

• You can touch buttons and drag the screen to scroll the list of the menu.

• The selected category icon is displayed in orange.

• When you touch **MY**, the screen returns to the MY MENU screen.

① Touch **MENU** (MENU).

② Touch [Show others] on the MY MENU screen.

• See the next page for details on MY MENU.

③ Touch the central part in the left side of screen to change the display.

④ Touch the menu item to be changed.

⑤ After changing the setting, touch **OK**.

To finish setting the menu, touch **X**.

To return to the previous menu screen, touch **↶**.

• **OK** may not be displayed depending on the menu item.

⚡ Notes

- You may not be able to set some menu items, depending on the recording or playback conditions.
- Grayed out menu items or settings are not available.

💡 Tips

- Depending on the menu items being changed, your camcorder switches between playback mode and recording mode (movie/photo).

Using MY MENU

You can use the menu items more easily by registering the menu items you use most often on MY MENU. You can register 6 menu items on each MY MENU of the MOVIE, PHOTO, and PLAYBACK.

Example: deleting [SPOT MTR/FCS] and registering [FADER]

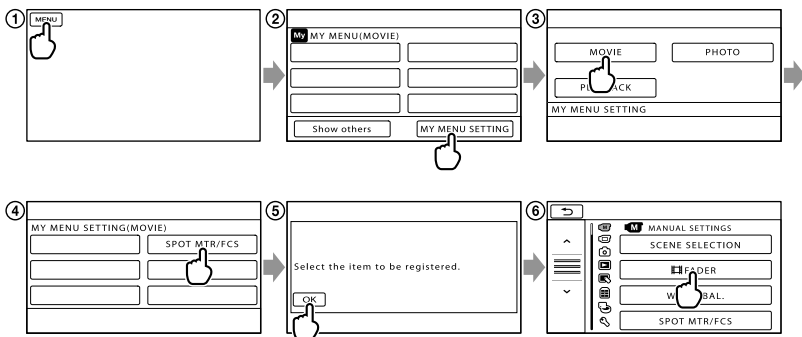



- ① Touch **MENU** (MENU).
- ② Touch **MY MENU SETTING**.
- ③ Touch **MOVIE**.
- ④ Touch **SPOT MTR/FCS**.
- ⑤ Touch **OK**.
- ⑥ Touch **FADER** (under **M** [MANUAL SETTINGS] category).
- ⑦ When MY MENU is displayed, touch **X**.

Repeat the same steps above to register menu items on MY MENU, and enjoy using your “Handycam.”



💡 Tips

- When an external storage device is connected, the exclusive MY MENU appears.

Using the OPTION MENU

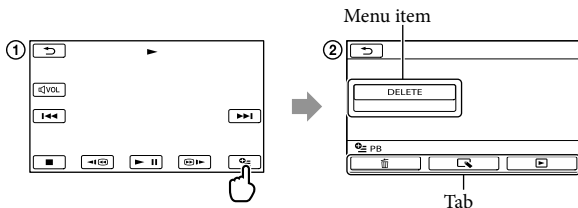
The OPTION MENU appears just like the pop-up window that appears when you right-click the mouse on a computer. When  is displayed at bottom-right of the screen, you can use the OPTION MENU. You touch , and the menu items you can change in the context appear.



- ① Touch  (OPTION).
- ② Touch the desired tab → the item to change the setting.
- ③ After completing the setting, touch .







Notes

- Grayed out menu items or settings are not available.
- When the item you want is not on the screen, touch another tab. (There may be no tab.)
- The tabs and items that appear on the screen depend on the recording/playback status of your camcorder at the time.



 (MANUAL SETTINGS) category

- SCENE SELECTION Selects an appropriate recording setting according to the type of scene, such as night view or beach.
-  FADER Fades scenes in or out.
- WHITE BAL Adjusts the color balance to the brightness of the recording environment.
- SPOT MTR/FCS Adjusts the brightness and focus for the selected subject simultaneously.
- SPOT METER Adjusts the brightness of images to a subject you touch on the screen.
- SPOT FOCUS Focuses on a subject you touch on the screen.
- EXPOSURE Adjusts the brightness of movies and photos.
- FOCUS Focuses manually.
- TELE MACRO Shoots a subject in focus with, the background out of focus.
- SMTH SLW REC Records fast moving subjects in slow-motion.







 (SHOOTING SET) category

-  /  SET Sets image quality for recording, playback, or editing movies.
-  REC MODE Sets the mode to record movies. When recording fast moving subject, a high image quality is recommended.
- GUIDEFAME Displays the frame to make sure the subject is horizontal or vertical.
-  STEADYSHOT Sets the SteadyShot function when recording movies.
- CONVERSION LENS Sets the type of an attached conversion lens (sold separately). Optimizes the SteadyShot function and focus according to the attached lens.
- LOW LUX Records bright color images in the dim.
- FACE DETECTION Adjusts the image quality of the face(s) automatically.
- PRIORITY SETTING Select the subject that has priority for the face detection and the smile shutter.
- SMILE DETECTION Automatically takes a shot whenever a smile is detected.
- SMILE SENSITIVITY Sets the smile detection sensitivity using the smile shutter function.
- AUDIO REC SET
- BLT-IN ZOOM MIC Records movies with vivid sound appropriate to the zoom position.
- MICREF LEVEL Sets the microphone level.
- OTHER REC SET
-  DIGITAL ZOOM Sets the maximum zoom level of the digital zoom that exceeds the zoom level of the optical zoom.
- AUTO BACK LIGHT Adjusts the exposure for backlit subjects automatically.
-  X.V.COLOR Records wider range of colors.
-  WIDE SELECT Sets the horizontal to vertical ratio when recording movies with standard definition image quality (STD).













(PHOTO SETTINGS) category







-  SELF-TIMER..... Sets the self-timer when your camcorder is in photo recording mode.
-  IMAGE SIZE..... Sets the photo size.
- FILE NO. Sets how to assign the file number.

(PLAYBACK) category

- VISUAL INDEX..... Displays recording images as thumbnails (p. 26).
- VIEW IMAGES
 - DATE INDEX..... Enables searching for desired images by date.
 -  FILM ROLL..... Displays and plays the scenes by a certain interval.
 -  FACE..... Displays and plays the face scenes.
- PLAYLIST..... Displays and plays the playlist of movies.
-  HIGHLIGHT..... Selects a number of short scenes and plays them back together as a digest of your movies with music and visual effects.
-  SCENARIO..... Plays the favorite scenario saved in Highlight Playback.
- PLAYBACK SET
 -  /  SET..... Sets image quality for recording, playback, or editing movies.
 - DATA CODE..... Displays the detailed recording data during playback.





(EDIT) category

- DELETE
 -  DELETE..... Deletes movies.
 -  DELETE..... Deletes photos.
-  SCENARIO ERASE
 - ERASE..... Erases scenarios saved in Highlight Playback.
 - ERASE ALL..... Erases all scenarios saved in Highlight Playback.
- PROTECT
 -  PROTECT..... Protects movies to avoid deleting.
 -  PROTECT..... Protects photos to avoid deleting.
-  DIVIDE..... Divides movies.
- PHOTO CAPTURE*1*2*4..... Captures photos from desired scenes of movies.
- MOVIE DUB*1*2
 - DUB by select..... Selects movies and dub.
 - DUB by date..... Dubs all movies of a specified date.
 -  DUB ALL/
 DUB ALL..... Dubs all saved movies in a playlist.
- PHOTO COPY*1*2
 - COPY by select..... Selects photos and copy.
 - COPY by date..... Copies all photos of a specified date.
- PLAYLIST EDIT
 -  ADD/  ADD..... Adds movies in a playlist.
 -  ADD by date/
 ADD by date..... Adds movies recorded on a same day at one time in a playlist.

-  ERASE/ ERASE ..Erases movies from a playlist.
-  ERASE ALL/
 ERASE ALLErases all movies from a playlist.
-  MOVE/ MOVE ... Changes the order of movies in a playlist.

(OTHERS) category

USB CONNECT

-  USB CONNECT*1 Connects the internal memory via USB.
-  USB CONNECT*2 Connects the internal hard disk via USB.
-  USB CONNECT Connects the memory card via USB.
- DISC BURN Allows you to save images onto discs by pressing the  (DISC BURN) button (p. 40).

TV CONNECT Guide Introduces the connection method depending on the TV type connected (p. 29).

MUSIC TOOL *3

- EMPTY MUSIC Deletes music files.
- DOWNLOAD MUSIC Download music files that can be played with Highlight Playback.
- BATTERY INFO Displays the battery information.

(MANAGE MEDIA) category

MEDIA SETTINGS

- MOVIE MEDIA SET*1*2 .. Sets the media for recording movies (p. 17).
- PHOTO MEDIA SET*1*2 .. Sets the media for recording photos (p. 18).

MEDIA INFO Displays information on the recording media, such as free space.

MEDIA FORMAT

- INT. MEMORY*1 Deletes all data on the internal memory.
- HDD*2 Deletes all data on the internal hard disk.
- MEMORY CARD*1*2 Deletes all data on the memory card.

REPAIR IMG.DB F.

- INT. MEMORY*1 Repairs the image database file on the internal memory (p. 64).
- HDD*2 Repairs the image database file on the internal hard disk (p. 64).
- MEMORY CARD*1*2 Repairs the image database file on the memory card (p. 64).

(GENERAL SET) category

SOUND/DISP SET

- VOLUME..... Adjusts the volume of playback sound (p. 28).
- BEEP Sets whether the camcorder sounds operation beeps or not.
- LCD BRIGHT Adjusts the brightness of the LCD screen.
- LCD BL LEVEL Adjusts the backlight of the LCD screen.
- LCD COLOR..... Adjusts the color intensity of the LCD screen.
- DISPLAY SET Sets the duration that icons or indicators are displayed on the LCD screen.

OUTPUT SETTINGS

- TV TYPE Converts the signal depending on the TV connected (p. 29).
- COMPONENT Select this option when you connect your camcorder to a TV with the component input jack (p. 30).
- HDMI RESOLUTION..... Selects the output image resolution when connecting your camcorder to a TV with an HDMI cable.
- DISP OUTPUT Sets whether the on-screen displays appears on the TV screen or not.

CLOCK/ LANG

- CLOCK SET Sets the date and time (p. 15).
- AREA SET Adjusts for a time difference without stopping the clock (p. 15).
- SUMMERTIME Sets the summertime (p. 15).
-  LANGUAGE SET Sets the display language (p. 16).

POWER SETTINGS

- A.SHUT OFF Changes the [A.SHUT OFF] setting (p. 13).
- POWER ON BY LCD Sets whether or not the camcorder is turned on and off when you open and close the LCD screen.

OTHER SETTINGS

- DEMO MODE..... Sets whether the demonstration appears or not.
- CALIBRATION Calibrates the touch panel.
- CTRL FOR HDMI Sets whether or not the TV's Remote Commander is to be used when the camcorder is connected to a "BRAVIA" Sync compatible TV with the HDMI cable (sold separately).
- DROP SENSOR*² Activates or deactivates the drop sensor.

*¹ HDR-CX116E/CX150E/CX155E

*² HDR-XR150E/XR155E

*³ HDR-CX110E/CX150E/XR150E

*⁴ HDR-CX110E

Getting detailed information from the “Handycam” Handbook

The “Handycam” Handbook is a user guide designed to be read on a computer screen. The “Handycam” Handbook is intended to be read when you want to know more about operating your camcorder.

1 _____
To install the “Handycam” Handbook on a Windows computer, place the supplied CD-ROM in the disc drive of your computer.

2 _____
On the installation screen displayed, click [Handbook].

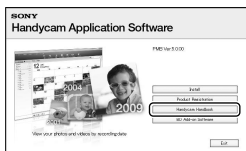

3 _____
Click the desired language and the model name of your camcorder → [Install], and follow the on-screen instructions to install “Handycam” Handbook.

- The model name of your camcorder is printed on its bottom surface.

To view the “Handycam” Handbook, double-click the short-cut icon on the computer screen.



- When using a Macintosh, open the [Handbook] – [GB] folder in the CD-ROM, then copy [Handbook.pdf].
- You need Adobe Reader to read “Handycam” Handbook. If it is not installed on your computer, you can download it from the Adobe Systems web page: <http://www.adobe.com/>
- Refer to “PMB Help” for details on the supplied software “PMB” (p. 37).

? Troubleshooting

If you run into any problems using your camcorder, follow the steps below.

① Check the list (p. 62 to 64), and inspect your camcorder.

② Remove the power source, attach the power source again after about 1 minute, and turn the camcorder on.

③ Press RESET (p. 73) using a pointed object, and turn the camcorder on. If you press RESET, all settings, including the clock setting, are reset.

④ Contact your Sony dealer or local authorized Sony service facility.

- Your camcorder may be required to initialize or change the current internal recording media of your camcorder, depending on the problem. In the event of this, the data stored on the internal recording media will be deleted. Be sure to save the data on the internal recording media on other media (backup) before sending your camcorder for repair. We will not compensate you for any loss of internal recording media data.
- During repair, we may check a minimum amount of data stored on the internal recording media in order to investigate the problem. However, your Sony dealer will neither copy nor retain your data.
- See the "Handycam" Handbook (p. 61) for details on the symptoms of your camcorder, and "PMB Help" (p. 37) on connecting your camcorder to a computer.

The power does not turn on.

- Attach a charged battery pack to the camcorder (p. 12).
- Connect the plug of the AC Adaptor to the wall outlet (wall socket) (p. 13).

The camcorder does not operate even when the power is set to on.

- It takes a few seconds for your camcorder to be ready to shoot after the power is turned on. This is not a malfunction.
- Disconnect the AC Adaptor from the wall outlet (wall socket) or remove the battery pack, then reconnect it after about 1 minute. If your camcorder still does not work, press RESET (p. 73) using a pointed object. (If you press RESET, all settings, including the clock setting, are reset.)
- The temperature of your camcorder is extremely high. Turn off the camcorder and leave it for a while in a cool place.
- The temperature of your camcorder is extremely low. Leave the camcorder with the power turned on. If you still cannot operate your camcorder, turn off the camcorder and take it to a warm place. Leave the camcorder there for a while, then turn on the camcorder.



Your camcorder gets warm.

- Your camcorder may become warm during operation. This is not a malfunction.

The power abruptly turns off.

- Use the AC Adaptor (p. 13).
- Turn on the power again.
- Charge the battery pack (p. 12).

Pressing START/STOP or PHOTO does not record images.

- Press MODE to turn on the  (Movie) or  (Photo) lamp.
- Your camcorder is recording the image you have just shot on the recording media. You cannot make any new recordings during this period.
- The recording media is full. Delete unnecessary images (p. 32).
- Total number of movie scenes or photos has exceeded the recordable capacity of your camcorder. Delete unnecessary images (p. 32).

The recording stops.

- The temperature of your camcorder is extremely high/low. Turn off your camcorder and leave it for a while in a cool/warm place.

"PMB" cannot be installed.

- Check the computer environment or installation procedure required to install "PMB" (p. 34).

"PMB" does not work correctly.

- Quit "PMB" and restart your computer.

The camcorder is not recognized by the computer.

- Disconnect devices from the USB jack of the computer other than the keyboard, mouse, and your camcorder.
- Disconnect the USB cable from the computer and your camcorder, and restart the computer, then connect the computer and your camcorder again in an orderly manner.

Self-diagnosis display/Warning indicators

If indicators appear on the LCD screen, check the following.

If the problem persists even after you have tried to fix a couple of times, contact your Sony dealer or local authorized Sony service facility. In this case, when you contact them, give them all the numbers of the error code beginning with C or E.

C:04:□□

- The battery pack is not an "InfoLITHIUM" battery pack V series. Use an "InfoLITHIUM" battery pack (V series) (p. 12).
- Connect the DC plug of the AC Adaptor to your camcorder securely (p. 12).

C:06:□□

- The battery pack temperature is high. Change the battery pack or place it in a cool place.

C:13:□□ / C:32:□□

- Remove the power source. Reconnect it and operate your camcorder again.

E:□□:□□

- Follow the steps from ② to ④ on page 62.



- The internal hard disk of your camcorder is full. Delete unnecessary images on the internal hard disk (p. 32).
- An error may have occurred with the internal hard disk of your camcorder.



- Battery power is low.



- The battery pack temperature is high. Change the battery pack or place it in a cool place.



- The temperature of your camcorder is getting high. Turn off your camcorder and leave it in a cool place.





- The temperature of your camcorder is low. Make the camcorder warm.



- No memory card is inserted (p. 18).
- When the indicator flashes, there is not enough free space for recording images. Delete unnecessary images (p. 32), or format the memory card after storing the images on other media.

Precautions

- The Image Database File is damaged. Check the data base file by touching  (MENU) → [Show others] → [REPAIR IMG.DB F.] (under  [MANAGE MEDIA] category) → the recording medium (HDR-CX116E/CX150E/CX155E/XR150E/XR155E).



- The memory card is damaged. Format the memory card with your camcorder (p. 59).



- Incompatible memory card is inserted (p. 18).



- Access to the memory card was restricted on another device.



- The camcorder is unsteady. Hold the camcorder steady with both hands. However, note that the camera-shake warning indicator does not disappear.



- The drop sensor function is activated. You may not be able to record nor play back images.



- The recording media is full. Delete unnecessary images (p. 32).
- Photos cannot be recorded during processing. Wait for a while, then record.

On use and care

- Do not use or store the camcorder and accessories in the following locations:
 - Anywhere extremely hot, cold or humid. Never leave them exposed to temperatures above 60 °C (140 °F), such as under direct sunlight, near heaters or in a car parked in the sun. They may malfunction or become deformed.
 - Near strong magnetic fields or mechanical vibration. The camcorder may malfunction.
 - Near strong radio waves or radiation. The camcorder may not be able to record properly.
 - Near AM receivers and video equipment. Noise may occur.
 - On a sandy beach or anywhere dusty. If sand or dust gets in your camcorder, it may malfunction. Sometimes this malfunction cannot be repaired.
 - Near windows or outdoors, where the LCD screen or the lens may be exposed to direct sunlight. This damages the inside of the LCD screen.
- Operate your camcorder on DC 6.8 V/7.2 V (battery pack) or DC 8.4 V (AC Adaptor).
- For DC or AC operation, use the accessories recommended in these operating instructions.
- Do not let your camcorder get wet, for example, from rain or sea water. If your camcorder gets wet, it may malfunction. Sometimes this malfunction cannot be repaired.
- If any solid object or liquid gets inside the casing, unplug your camcorder and have it checked by a Sony dealer before operating it any further.
- Avoid rough handling, disassembling, modifying, physical shock, or impact such as hammering, dropping or stepping on the product. Be particularly careful of the lens.
- Keep the camcorder turning off when you are not using your camcorder.
- Do not wrap your camcorder with a towel, for example, and operate it. Doing so might cause heat to build up inside.
- When disconnecting the power cord (mains lead), pull it by the plug and not the cord (lead).

- Do not damage the power cord (mains lead) such as by placing anything heavy on it.
- Do not use a deformed or damaged battery pack.
- Keep metal contacts clean.
- If the battery electrolytic liquid has leaked:
 - Consult your local authorized Sony service facility.
 - Wash off any liquid that may have contacted your skin.
 - If any liquid gets in your eyes, wash with plenty of water and consult a doctor.

When not using your camcorder for a long time

- To keep your camcorder in optimum state for a long time, turn it on and let it run by recording and playing back images about once a month.
- Use up the battery pack completely before storing it.

LCD screen

- Do not exert excessive pressure on the LCD screen, as it may cause damage.
- If your camcorder is used in a cold place, a residual image may appear on the LCD screen. This is not a malfunction.
- While using your camcorder, the back of the LCD screen may heat up. This is not a malfunction.

To clean the LCD screen

- If fingerprints or dust make the LCD screen dirty, it is recommended that you use a soft cloth to clean it.

On handling the casing

- If the casing is soiled, clean the camcorder body with a soft cloth lightly moistened with water, and then wipe the casing with a dry soft cloth.
- Avoid the following to avoid damage to the finish:
 - Using chemicals such as thinner, benzene, alcohol, chemical cloths, repellent, insecticide and sunscreen

- Handling the camcorder with above substances on your hands
- Leaving the casing in contact with rubber or vinyl objects for a long period of time

About care and storage of the lens

- Wipe the surface of the lens clean with a soft cloth in the following instances:
 - When there are fingerprints on the lens surface
 - In hot or humid locations
 - When the lens is exposed to salty air such as at the seaside
- Store in a well-ventilated location subject to little dirt or dust.
- To prevent mold, periodically clean the lens as described above.

On charging the pre-installed rechargeable battery

Your camcorder has a pre-installed rechargeable battery to retain the date, time, and other settings even when the camcorder is turned off. The pre-installed rechargeable battery is always charged while your camcorder is connected to the wall outlet (wall socket) via the AC Adaptor or while the battery pack is attached. The rechargeable battery will be fully discharged in about 3 months if you do not use your camcorder at all. Use your camcorder after charging the pre-installed rechargeable battery. However, even if the pre-installed rechargeable battery is not charged, the camcorder operation will not be affected as long as you are not recording the date.

Procedures

Connect your camcorder to a wall outlet (wall socket) using the supplied AC Adaptor, and leave it with the LCD screen closed for more than 24 hours.

Specifications

Note on disposal/transfer of the camcorder (HDR-CX116E/CX150E/CX155E/XR150E/XR155E)

Even if you delete all movies and still images, or perform [MEDIA FORMAT], data on the internal recording media may not be completely erased.

When you transfer the camcorder, it is recommended that you perform [EMPTY] (See "Getting detailed information from the "Handycam" Handbook" on page 61.) to prevent the recovery of your data. Also, when you dispose of the camcorder, it is recommended that you destroy the actual body of the camcorder.

Note on disposal/transfer of memory card

Even if you delete data in the memory card or format the memory card on your camcorder or a computer, you may not delete data from the memory card completely. When you give the memory card to somebody, it is recommended that you delete data completely using data deletion software on a computer. Also, when you dispose of the memory card, it is recommended that you destroy the actual body of the memory card.

System

Signal format: PAL color, CCIR standards
HDTV 1080/50i specification

Movie recording format:

HD: MPEG-4 AVC/H.264 AVCHD format compatible
STD: MPEG-2 PS

Audio recording system:

Dolby Digital 2ch
Dolby Digital Stereo Creator

Photo recording format

: DCF Ver.2.0 Compatible
: Exif Ver.2.21 Compatible
: MPF Baseline Compatible

Recording media (Movie/Photo)

Internal memory
HDR-CX116E: 8GB
HDR-CX150E/CX155E: 16GB
Internal hard disk
HDR-XR150E/XR155E: 120GB
"Memory Stick PRO Duo" media
SD card (Class 4 or faster)

When measuring media capacity, 1 GB equals 1 billion bytes, a portion of which is used for system management and/or application files. The capacity that a user can use is below.

HDR-CX116E:
approximately 7.87 GB
HDR-CX150E/CX155E:
approximately 15.5 GB
HDR-XR150E/XR155E:
approximately 119 GB

Image device: 4.5 mm (1/4 type) CMOS sensor

Recording pixels (photo, 4:3):
Max. 3.1 mega (2 048 × 1 536) pixels*1
Gross: Approx. 4 200 000 pixels
Effective (movie, 16:9):
Approx. 1 350 000 pixels*2
Effective (photo, 16:9):
Approx. 1 180 000 pixels
Effective (photo, 4:3):
Approx. 1 570 000 pixels

Lens: Carl Zeiss Vario-Tessar

25 × (Optical), 300 × (Digital)
Filter diameter: 30 mm (1 3/16 in.)
F1.8 ~ 3.2
Focal length:
f=2.5 ~ 62.5 mm (1/8 ~ 2 1/2 in.)
When converted to a 35 mm still camera
For movies*2*3: 37 ~ 1 075 mm (1 1/2 ~ 42 3/8 in.) (16:9)

For photos: 36 ~ 900 mm (1 7/16 ~ 35 1/2 in.) (4:3)

Color temperature: [AUTO], [ONE PUSH], [INDOOR] (3 200 K), [OUTDOOR] (5 800 K)

Minimum illumination

1 lx (lux) (in default setting, shutter speed 1/50 second)

3 lx (lux) (LOW LUX is set to [ON], shutter speed 1/25 second)

*1 The unique pixel array of Sony's ClearVid and the image processing system (BIONZ) allow still image resolution equivalent to the sizes described.

*2 [STEADYSHOT] is set to [STANDARD] or [OFF].

*3 The focal length figures are actual figures resulting from wide angle pixel read out.

Input/Output connectors

A/V Remote Connector: Component/video and audio output jack

HDMI OUT jack: HDMI mini connector

USB jack: mini-AB
(HDR-CX115E/CX116E/CX155E/XR155E: output only)

LCD screen

Picture: 6.7 cm (2.7 type, aspect ratio 16:9)

Total number of pixels: 230 400 (960 × 240)

General

Power requirements: DC 6.8 V/7.2 V (battery pack) DC 8.4 V (AC Adaptor)

Average power consumption: During camera recording, using LCD screen at normal brightness:

HDR-CX110E/CX115E/CX116E/CX150E/CX155E

HD: 3.0 W STD: 2.1 W

HDR-XR150E/XR155E

HD: 3.3 W STD: 2.4 W

Operating temperature: 0 °C to 40 °C (32 °F to 104 °F)

Storage temperature: -20 °C to + 60 °C (-4 °F to +140 °F)

Dimensions (approx.):

HDR-CX110E/CX115E/CX116E/CX150E/CX155E

50 × 56 × 106 mm (2 × 2 1/4 × 4 1/4 in.) (w/h/d) including the projecting parts

50 × 56 × 114 mm (2 × 2 1/4 × 4 1/2 in.) (w/h/d) including the projecting parts, and the supplied rechargeable battery pack attached

HDR-XR150E/XR155E

57 × 67 × 106 mm (2 1/4 × 2 3/4 × 4 1/4 in.)

(w/h/d) including the projecting parts

57 × 67 × 114 mm (2 1/4 × 2 3/4 × 4 1/2

in.) (w/h/d) including the projecting parts, and the supplied rechargeable battery pack attached

Mass (approx.)

HDR-CX110E/CX115E/CX116E/CX150E/CX155E:

210 g (7 oz) main unit only

260 g (9 oz) including the supplied rechargeable battery pack

HDR-XR150E/XR155E:

300 g (10 oz) main unit only

350 g (12 oz) including the supplied rechargeable battery pack

AC Adaptor AC-L200C/AC-L200D

Power requirements: AC 100 V - 240 V, 50 Hz/60 Hz

Current consumption: 0.35 A - 0.18 A

Power consumption: 18 W

Output voltage: DC 8.4 V*

Operating temperature: 0 °C to 40 °C (32 °F to 104 °F)

Storage temperature: -20 °C to + 60 °C (-4 °F to +140 °F)

Dimensions (approx.): 48 × 29 × 81 mm (1 15/16 × 1 3/16 × 3 1/4 in.) (w/h/d) excluding the projecting parts

Mass (approx.): 170 g (6.0 oz) excluding the power cord (mains lead)

* See the label on the AC Adaptor for other specifications.

Rechargeable battery pack NP-FV50

Maximum output voltage: DC 8.4 V

Output voltage: DC 6.8 V

Maximum charge voltage: DC 8.4 V

Maximum charge current: 2.1 A

Capacity

Typical: 7.0 Wh (1 030 mAh)

Minimum: 6.6 Wh (980 mAh)

Type: Li-ion

Design and specifications of your camcorder and accessories are subject to change without notice.

- Manufactured under license from Dolby Laboratories.

Expected charging and running time for the supplied battery pack (in minute)

HDR-CX110E/CX115E/CX116E/CX150E/CX155E



Image quality	HD	STD
Charging time (full charge)	155	
Continuous recording time	125	180
Typical recording time	60	90
Playback time	190	280

HDR-XR150E/XR155E

Image quality	HD	STD
Charging time (full charge)	155	
Continuous recording time	110	155
Typical recording time	55	75
Playback time	170	225

- Recording and playback time is approximate time available using a fully charged battery pack.
- High definition image quality (HD)/Standard definition image quality (STD)
- Recording condition: [ REC MODE] is set to [HQ].
- Typical recording time shows the time when you repeat recording start/stop, turning the power on/off and zooming.

Expected recording time of movies

- To set the recording mode, touch **MENU** (MENU) → [Show others] → [ REC MODE] (under  [SHOOTING SET] category). In the default setting, the recording mode is [HD HQ].

Internal memory

HDR-CX116E

High definition image quality (HD) in h (hour) and m (minute)

Recording mode	Recording time
[HD FX]	45 m
[HD FH]	55 m
[HD HQ]	1 h 55 m
[HD LP]	3 h 15 m

Standard definition image quality (STD) in h (hour) and m (minute)

Recording mode	Recording time
[STD HQ]	2 h

HDR-CX150E/CX155E

High definition image quality (HD) in h (hour) and m (minute)

Recording mode	Recording time
[HD FX]	1 h 25 m
[HD FH]	1 h 55 m
[HD HQ]	3 h 50 m
[HD LP]	6 h 35 m

Standard definition image quality (STD) in h (hour) and m (minute)

Recording mode	Recording time
[STD HQ]	3 h 55 m

Internal hard disk

HDR-XR150E/XR155E

High definition image quality (HD) in h (hour) and m (minute)

Recording mode	Recording time
[HD FX]	11 h 20 m
[HD FH]	14 h 50 m
[HD HQ]	29 h 40 m
[HD LP]	50 h 30 m

Standard definition image quality (STD) in h (hour) and m (minute)

Recording mode	Recording time
[STD HQ]	30 h 30 m

Example of expected recording time of movies in a memory card (in minute)

Recording mode	For 4 GB capacity	
	High definition (HD)	Standard definition (STD)
[FX]	20 (20)	-
[FH]	25 (25)	-
[HQ]	55 (40)	55 (50)
[LP]	90 (75)	-

- The number in () is the minimum recordable time.
- The recordable time may vary depending on the recording and subject conditions and [RECORD MODE].
- On charging/recording/playback time
 - Measured when using the camcorder at 25 °C (77 °F) (10 °C to 30 °C (50 °F to 86 °F) is recommended)
 - The recording and playback time will be shorter in low temperatures, or depending on the conditions under which you use your camcorder.

On trademarks

- “Handycam” and **HANDYCAM** are registered trademarks of Sony Corporation.
- “AVCHD” and “AVCHD” logotype are trademarks of Panasonic Corporation and Sony Corporation.
- “Memory Stick,”  “Memory Stick Duo,” “**MEMORY STICK DUO**,” “Memory Stick PRO Duo,” “**MEMORY STICK PRO DUO**,” “Memory Stick PRO-HG Duo,” “**MEMORY STICK PRO-HG DUO**,” “MagicGate,” “**MAGICGATE**,” “MagicGate Memory Stick” and “MagicGate Memory Stick Duo” are trademarks or registered trademarks of Sony Corporation.
- “InfoLITHIUM” is a trademark of Sony Corporation.
- “x.v.Colour” is a trademark of Sony Corporation.
- “BIONZ” is a trademark of Sony Corporation.
- “BRAVIA” is a trademark of Sony Corporation.
- “DVDirect” is a trademark of Sony Corporation.
- “Blu-ray Disc” and the logo are trademarks.
- Dolby and the double-D symbol are trademarks of Dolby Laboratories.
- HDMI, the HDMI logo and High-Definition Multimedia Interface are trademarks or registered trademarks of HDMI Licensing LLC.
- Microsoft, Windows, Windows Vista, and DirectX are either registered trademarks or trademarks of Microsoft Corporation in the United States and/or other countries.
- Macintosh and Mac OS are registered trademarks of Apple Inc. in the U.S. and other countries.
- Intel, Intel Core, and Pentium are trademarks or registered trademarks of Intel Corporation or its subsidiaries in the United States and other countries.
- “PlayStation” is a registered trademark of Sony Computer Entertainment Inc..
- Adobe, the Adobe logo, and Adobe Acrobat are either registered trademarks or trademarks of Adobe Systems Incorporated in the United States and/or other countries.
- SDXC and SDHC logos are trademarks of SD-3C, LLC.
- MultiMediaCard is a trademark of MultiMediaCard Association.

All other product names mentioned herein may be the trademarks or registered trademarks of their respective companies. Furthermore, TM and ® are not mentioned in each case in this manual.

Screen indicators

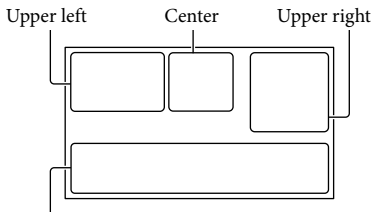

Bottom

Upper left

Indicator	Meaning
	MENU button
	Self-timer recording
	MICREF LEVEL low
	WIDE SELECT
	BLT-IN ZOOM MIC
60 min	Remaining battery
101	Recording folder
	Return button

Center

Indicator	Meaning
[STBY]/[REC]	Recording status
3.1M 2.4M 1.9M LVGA	Photo size
	Slide show set
	Warning
	Playback mode
	Drop sensor off
	Drop sensor activated

Upper right





Indicator	Meaning
	Recording image quality (HD/STD) and recording mode (FX/FH/HQ/LP)
	Recording/playback/editing media
0:00:00	Counter (hour:minute:second)
[00min]	Estimated recording remaining time
WHITE BLACK FADER FADER	FADER
9999	Approximate number of recordable photos and recording media
101	Playback folder
100/112	Current playing movie or photo/Number of total recorded movies or photos

Bottom

Indicator	Meaning
OFF	[FACE DETECTION] set to [OFF]
	SMILE DETECTION
	LOW LUX
	Manual focus
	SCENE SELECTION
	White balance
	SteadyShot off
	SPOT MTR/FCS / SPOT METER / EXPOSURE
	TELE MACRO
(COLOR)	X.V.COLOR
	CONVERSION LENS
	INTELLIGENT AUTO
	OPTION button
	VIEW IMAGES button

Parts and controls

Figures in () are reference pages.

Indicator	Meaning
	Slide show button
 101-0005	Data file name
	Protected image
	Index button

- Indicators and their positions are approximate and may differ from what you actually see.
- Some indicators may not appear, depending on your camcorder model.

HDR-CX110E/CX115E/CX116E/ CX150E/CX155E

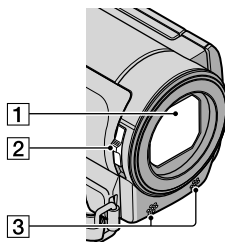

HDR-XR150E/XR155E

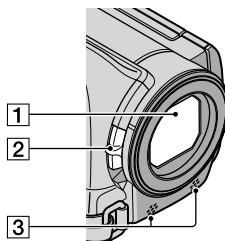

- 1 Lens (Carl Zeiss lens)
- 2 LENS COVER switch (21)
- 3 Built-in microphone

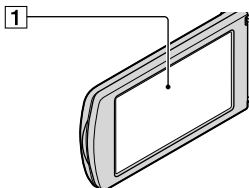

1 LCD screen/Touch panel

If you rotate the LCD panel 180 degrees, you can close the LCD panel with the LCD screen facing out. This is convenient during playback operations.

3 RESET button

Press RESET using a pointed object.

Press RESET to initialize all the settings including the clock setting.

4 HDMI OUT jack (29)

5 Ψ (USB) jack (36, 40, 41, 45, 48)

HDR-CX115E/CX116E/CX155E/XR155E:
output only

6 MODE button (22)

7 (movie)/ (Photo) lamps (22)

8 (DISC BURN) button (40)

9 (INTELLIGENT AUTO) button

10 POWER button (15)

**HDR-CX110E/CX115E/CX116E/
CX150E/CX155E**

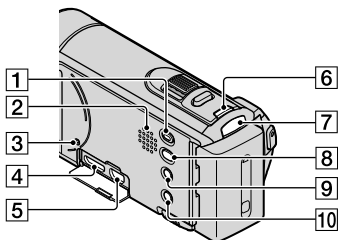

**HDR-CX110E/CX115E/CX116E/
CX150E/CX155E**

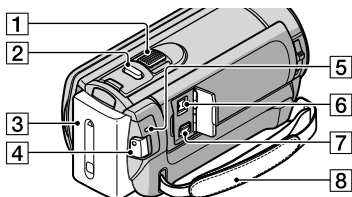

HDR-XR150E/XR155E

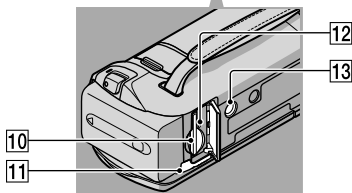
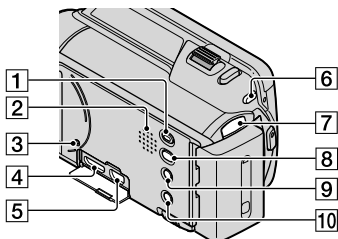

1 (VIEW IMAGES) button (26)

2 Speaker

HDR-XR150E/XR155E

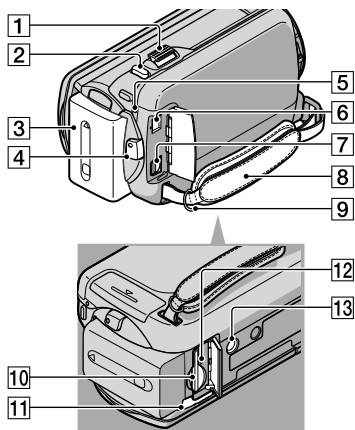

- 1 Power zoom lever
- 2 PHOTO button (25)
- 3 Battery pack (12)
- 4 START/STOP button (23)
- 5 CHG (charge) lamp (12)
- 6 DC IN jack (12)
- 7 A/V Remote Connector (29)
- 8 Grip belt (21)
- 9 Hook for a shoulder belt
- 10 Memory card slot (19)
- 11 BATT (battery) release lever (13)
- 12 Memory card Access lamp (19)
While the lamp is lit or flashing, the camcorder is reading or writing data.
- 13 Tripod receptacle
Attach a tripod (sold separately) to the tripod receptacle using a tripod screw (sold separately: the length of the screw must be less than 5.5 mm (7/32 in.)).

Index

- A**
- A/V connecting cable.....30, 52
 - AVCHD.....38
- B**
- Battery pack.....12
 - Blu-ray disc.....43
- C**
- Capturing photos from a movie.....44
 - Care64
 - Charging the battery abroad14
 - Charging the battery pack12
 - CLOCK SET15
 - Computer.....34
 - Computer system.....34
 - Copying a disc.....44
 - Creating a disc38, 47
 - Creating a standard definition image quality (STD) disc.....43
 - Creating AVCHD disc42
- D**
- DATA CODE16
 - DATE/TIME.....16
 - DELETE.....32
 - Disc recorder.....52
 - Dubbing.....20
 - DVDirect Express.....48
 - DVD writer.....48, 51
- E**
- Editing movies44
 - External media.....45
- F**
- Fully charged.....12
- H**
- “Handycam” Handbook.....61
- I**
- Image quality.....57
 - Install.....35
- L**
- LANGUAGE SET16
- M**
- Macintosh.....35
 - Maintenance.....64
 - MANAGE MEDIA17
 - MEDIA SETTINGS.....17
 - Memory card.....18
 - “Memory Stick” media.....18
 - “Memory Stick PRO-HG Duo” media.....18
 - “Memory Stick PRO Duo” media.....18
 - Menus.....54, 57
 - MOVIE MEDIA SET17
 - Movies.....23, 27
 - MY MENU54
 - MY MENU SETTING.....54
- O**
- One Touch Disc Burn40
 - Operation flow.....9
 - OPTION MENU56
- P**
- Parts and controls72
 - PHOTO MEDIA SET18
 - Photos25, 28
 - Playing.....26
 - Playing AVCHD disc.....42
 - PMB (Picture Motion Browser).....34, 37
 - PMB Help.....37
 - Power on.....15
 - Precautions64
- R**
- Recording21
 - Recording and playback time ..68
 - Recording media.....17
 - Repair.....62
 - RESET73
- S**
- Saving images in external media.....45
 - Screen indicators71
 - Self-diagnosis display.....63
 - Setting the date and time.....15
 - Software35
 - Specifications66
 - Supplied items.....5
- T**
- Thumbnail32
 - Tripod.....74
 - Troubleshooting.....62
 - Turning the power on15
 - TV.....29
 - TV CONNECT Guide.....29
- U**
- USB cable.....48, 51
 - USB CONNECT41, 51
- V**
- VISUAL INDEX26
 - Volume.....28
- W**
- Wall outlet (wall socket).....12
 - Warning indicators.....63
 - Windows.....34

You will find the menu lists on pages 57 to 60.

Additional information on this product and answers to frequently asked questions can be found at our Customer Support Website.

<http://www.sony.net/>

Printed on 70% or more recycled paper.

Printed in China



4170897140