

COBY®

DVD-615

User Manual

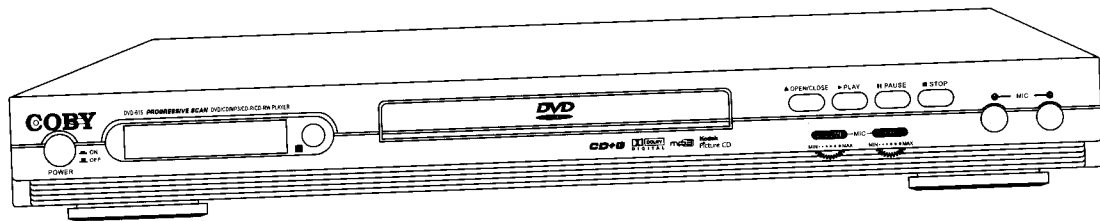

Please read this User Manual carefully to ensure proper use of this product and keep this manual for further reference.

Safety Precaution

CAUTION:



The lightning flash with arrowhead symbol, within an equilateral triangle, is intended to alert the user to " dangerous voltage " and to prevent from a risk of electric shock.

CAUTION
RISK OF ELECTRIC SHOCK
DO NOT OPEN

Warning:
To reduce the risk of electric shock, don't open the cabinet. Refer servicing to qualified personnel only.



The exclamation point within an equilateral triangle is intended to alert the user to important operating and maintenance (servicing).

WARNING: Do not use this DVD play where contact with or immersion in water us a possibility. Do not use near bathtubs, washbowls, kitchen sinks, laundry tubs, swimming pools, etc.

WARNING: The unit should be connected to a power supply only of the type described in the operating instructions or as marked on the unit. If you are ont sure of the type of power supply (for example, 120 or 230V)to your home, consult your local dealer or local power company.

Note: When the unit is unused for a long period of time, the unit should be unplugged from the household AC outlet.

WARNING: Slots and openings in the cabinet are provided for ventilation to protect it from overheating. Do not block those openings or allow them to be blocked by placing the DVD player on a bed, sofa, or other similar surface, nor should it be placed over a radiator or heat register.

WARNING: THIS PRODUCT UTILIZES A LASER. DO NOT OPEN COVERS AND REFER SERVICING TO QUALIFIED PERSONNEL. AVOID DIRECT EXPOSURE TO LASER BEAM.

Note: After turning off the unit's power, you can clean the cabinet, panel and remote control with a soft cloth lightly moistened with a mild detergent solution.

Note: Moisture may form on the lens in the following conditions...

- - when the unit is suddenly moved from a cold environment to a warm one.
- - immediately after a heater has been turned on.
- - in a steamy or very humid room.

IF moisture forms inside the unit, it may not operate properly. To correct this problem, turn on the power and wait about two hours for the moisture to evaporate.

Note: Preparing the Remote Control

1. Open the cover.
 2. Insert two batteries and make sure to match + and - (polarity) on the battery compartment.
 3. Close the cover.
- **Distance:** About 7 m from the front of the remote sensor.
 - **Angle:** About 30° in each direction of the front of the remote sensor.
 - IF the remote control is not used for a long period of time, remove the batteries to prevent leakage.

DVD Precaution:

Handling:

- Do not touch the playback side of the disc. And do not attach paper or tape to discs.
- Fingerprints and dust on the disc will cause picture and sound deterioration. Wipe the disc from the center outwards with a soft cloth. Always keep the disc clean.

Cleaning:

- Do not use any type of solvent such as thinner, benzene, commercially available cleaners or antistatic spray for vinyl Lps. It may damage the disc.

NOTE: To ensure proper use of this product please read this User manual carefully and retain for further reference.

TABLE OF CONTENTS

1. Brief instruction of controls	1
Front panel function	1
Back panel function.....	1
Remote Control	2
VFD	2
2. Connection	3
Accessories	3
Battery installation of remote control.....	3
System connection	3
3. Basic Operation	4
4. Playing Mp3	12
5. Playing JPEG	13
6. DVD player System Description	14
7. KARAOKE FUNCTION.....	20
8. Troubleshooting	21
9. Technical Specification	23

1. Brief instruction of controls

Front panel function:

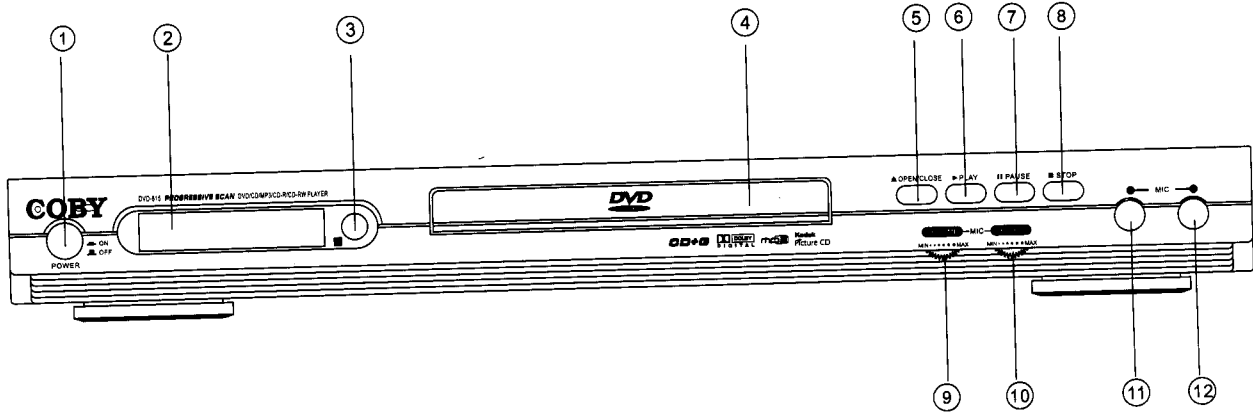

- | | | |
|--------------|--------------|--------------|
| ① POWER | ⑤ OPEN/CLOSE | ⑨ MIC VOL |
| ② VFD SCREEN | ⑥ PLAY | ⑩ MIC ECHO |
| ③ SENSOR | ⑦ PAUSE | ⑪ MIC 1 JACK |
| ④ DISC TRAY | ⑧ STOP | ⑫ MIC 2 JACK |

Back panel function:

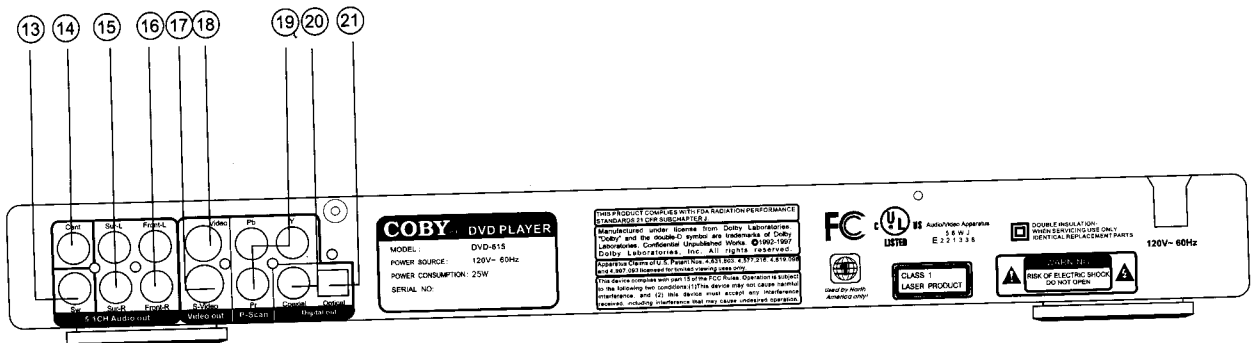

- | | |
|----------------------------|--|
| ⑬ 5.1 CH SW output jack | ⑱ Video output jack |
| ⑭ 5.1 CH CEN output jack | ⑲ Component output jack for Progressive Scan |
| ⑮ 5.1 CH SUR output jack | ⑳ Digital signal coaxial output jack |
| ⑯ 5.1 CH FRONT output jack | ㉑ Digital signal optical output jack |
| ⑰ S-Video output jack | |

Remote Control

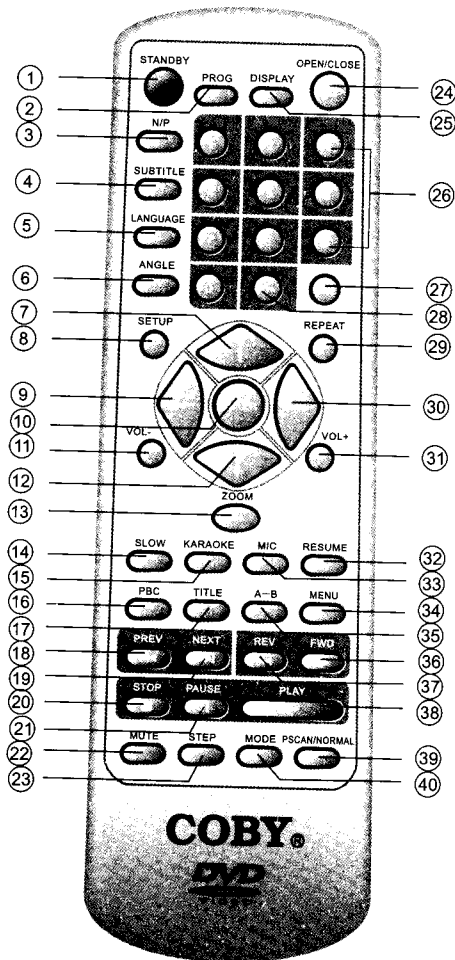

- | | |
|------------|-------------------|
| ① STANDBY | ②① PAUSE |
| ② PROGRAM | ②② MUTE |
| ③ NTSC/PAL | ②③ STEP |
| ④ SUBTITLE | ②④ OPEN/CLOSE |
| ⑤ LANGUAGE | ②⑤ DISPLAY |
| ⑥ ANGLE | ②⑥ 0-9 NUMBER KEY |
| ⑦ UP | ②⑦ TIME |
| ⑧ SETUP | ②⑧ 10+ KEY |
| ⑨ LEFT | ②⑨ REPEAT |
| ⑩ ENTER | ③⑩ RIGHT |
| ⑪ VOL - | ③① VOL + |
| ⑫ DOWN | ③② RESUME |
| ⑬ ZOOM | ③③ MIC |
| ⑭ SLOW | ③④ MENU |
| ⑮ KARAOKE | ③⑤ A-B REPEAT |
| ⑯ PBC | ③⑥ FWD |
| ⑰ TITLE | ③⑦ REV |
| ⑱ PREVIOUS | ③⑧ PLAY |
| ⑲ NEXT | ③⑨ PSCAN/NORMAL |
| ⑳ STOP | ④⑩ MODE |

VFD

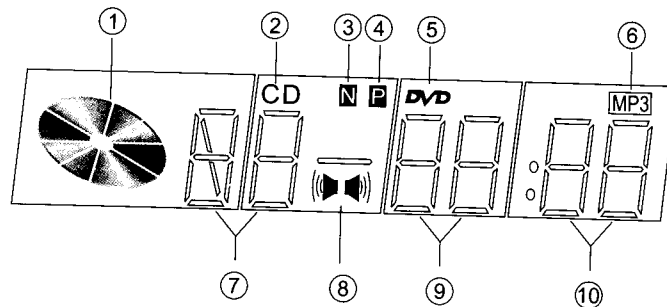

- | | | |
|------------------|------------------|-----------------------|
| ① Play Indicator | ④ PAL Mode | ⑦ Song Number display |
| ② Disc Type(CD) | ⑤ Disc Type(DVD) | ⑧ Channel |
| ③ NTSC Mode | ⑥ Mp3 | ⑨ Time (minute) |
| | | ⑩ Time(second) |

2. Connection

2.1 Accessories

1. Remote control
 2. Audio/Video cable
 3. User's manual
 4. Guarantee card
- (Check to make sure all equipment is accounted for after opening box)

2.2 Battery installation

Place two batteries in the battery compartment. Be sure the polarities are correct. There should be no large obstacles between the remote controller and the main unit.

2.3 System connection

1. When connecting this unit to other components, make sure all equipment is powered OFF.
For Progressive Scan function, TV must be equipped with component input (usually red, green & white). Otherwise you can only use the Video output jack (yellow).
2. Audio/Video cables are connected according to the different color identification and they should be fitted firmly.

Yellow to video terminal
White to audio terminal
Red to audio terminal

3. Scheme of connection

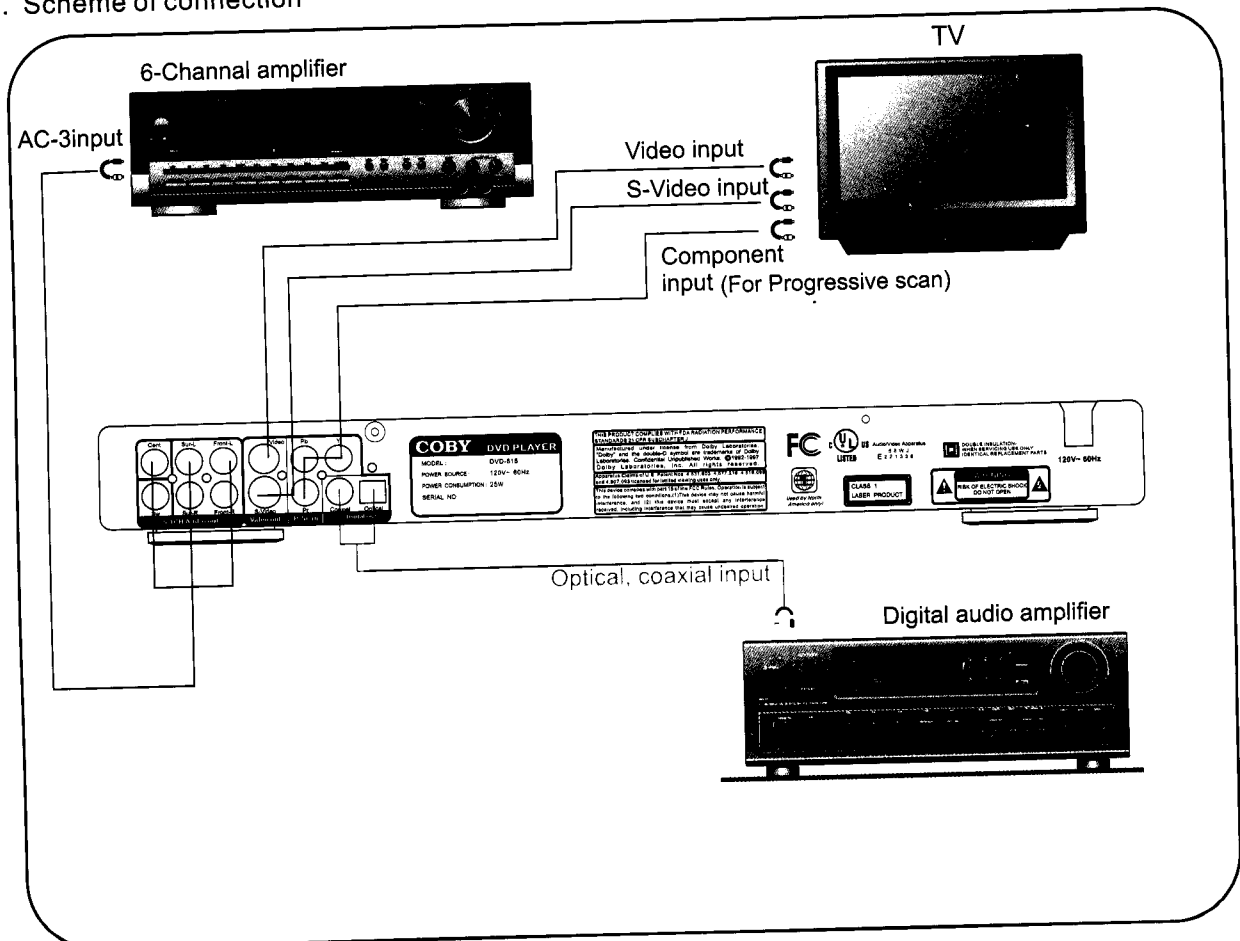

3. Basic Operation

Note All the following Icons are shown on OSD (On-screen Display) during operation.

STOP

There are two kinds of Stop . Stop1:Press " stop " button once; and Stop2: Press " stop " button twice.

Stop1 means Pause. You can press the Play button to continue playing from where you left off. Stop2 means Stop. When you press the play button, it will start from the beginning.

Stop1 and Stop2 can be prompted on Top Message. According to Setup Menu setting, the subtitle language can be Chinese or English.

PAUSE

While the DVD is playing, you can press **pause** button,

■ DVD



Still mode (Freeze Frame)

■ CD/MP3



Pause mode (The sound is muted.)

N/P

Press N/P button to switch from NTSC,PAL or AUTO mode on the screen.

MENU

Press MENU key to return to main menu

DIRECTION KEY

The four direction keys enable you to select your options in the Menu or Set up.

TITLE

Press TITLE key to return to the title menu for DVD disc playing.

L/R

When playing CD disc, press L/R key to select left, right, stereo.

VOL-/VOL+

Press volume <VOL+> key to increase volume, press <VOL-> key to reduce volume till to no volume output.

OPEN/CLOSE

Press OPEN/CLOSE key, the tray comes out automatically, then place disc on the tray. Press OPEN/CLOSE key to close the tray.

STANDBY

Press STANDBY key on the remote controller to bring the unit into standby status. It's power consumption is about 8W.

STEP

 During still mode, press this button to advance the picture one frame at a time. Press **Play** button to resume normal playback.

NEXT

During playback, press this button to skip a chapter (DVD Chapter or a track CD Mp3).



PREVIOUS

During playback, press this button to go to the previous chapter (DVD Chapter or a track CD MP3).



FWD

During playback, press this button to search at the next speed.

 Press this button again and the forward speed becomes faster. With each consecutive press of this button, the forward search speed increases.

Press "Play" button to resume normal playback.

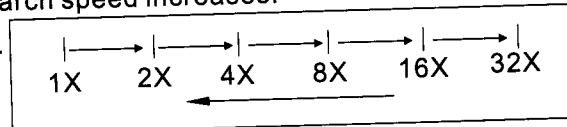

REV

During playback, press this button to search at the next speed.

 Press this button again and the reverse speed becomes faster. With each consecutive press of this button, the reverse search speed increases.

Press "Play" button to resume normal playback.

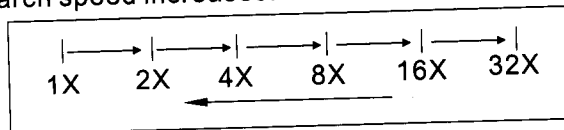

SLOW

During Playback, press slow

 With each consecutive press of the slow button, the playback speed decreases. For example, the first press of the button plays back at 1/2 normal speed, the second press plays back at 1/4 speed, etc.

Press "Play" button to resume normal playback.

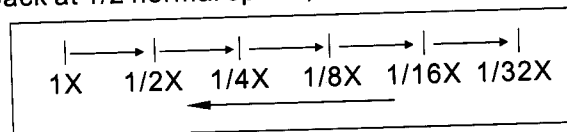

TIME

In normal playback mode, Time Search lets you jump to the desired time from which you want to start your playback. Time Search for MP3 disc can only search time in current track.

Press " Search " button to bring up Time Search Menu  _ _ _ _ _

- Enter the time you desire in the form of " hour: minute: second ", then press " Enter " button to start playback.
- IF the time you enter exceeds disc's playback time, the disc will do back to its start point.
- When the time you enter is not in correct time form, it will be convert into correct time form and start playback. (If the time doesn't exceed disc's total playback time.)

Title/Chapter Search allows you directly jump to the desired Title or Chapter during normal playback mode,

Press " Time " button to bring up Time Search Menu, then press " Time " button again to bring up Title/Chapter Menu as below:

T 01/05 © 04/32

- Press Left/Right buttons to select the number block of Title/Chapter you want to search.
- Enter the number within the sum number, then press " Enter " to jump to desired Title or Chapter.
- When the number you enter exceeds maximum number, the current Title/Chapter number will be displayed.

SUBTITLES

You can use Subtitle feature to change subtitle from one language to another language. During playback, the subtitle will be displayed in the default language; however, the following methods can be used to change subtitles.

Method 1 :

- During DVD's playback, press " Display " button
- Console Menu will be displayed on Screen, and then highlight this item 
- Press Left/Right arrow button or number button to select the subtitle you need.

Method 2:

- During DVD's playback, press " Subtitle " button
- Screen will display the  symbol and the next subtitle appears.
- Press " Subtitle " button to scroll through the available button.

While changing subtitles, Top Message for current subtitle will be displayed on the upper left corner of the Screen.

LANGUAGE

When a DVD is recorded with multiple soundtracks, you can use the language feature to change the audio language.

Method 1 :

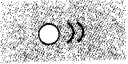
- During playback, press "Display" button
- Console Menu appears on the screen, and highlight the symbol .
- Press Left/Right arrow button or number button to select the subtitle you need.

Method 2:

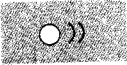
- During playback, press "Language " button
- The symbol  appears on screen, and the next language (soundtrack) is played. Keep pressing the "Language " button to scroll through available languages.

While changing Language, Top Message for current subtitle will be displayed on the upper left corner of the Screen.

MUTE

The Mute function is to mute/restore the sound of playback of any disc.

Mute OFF Press "Mute" button during playback, to turn the sound off.

Mute During the playback in mute mode, press the "Mute" button again to restore sound.

The Mute symbol remains on the screen until the mute feature is canceled.

Angle

Some DVDs contain multiple angles of a particular scene or sequence. This DVD player supports 2 methods for viewing camera angles.

Method 1:

- During playback, press "Display" button
- Console Menu will appear on screen, then highlight the symbol .
- Press Left/ Right arrow button or number button to select camera angle.

Method 2:

- During playback, press "Angle" button.
- Screen will show  symbol, and different camera angles will be shown by continuing to press Angle button.

Note: This feature does not work when the DVD has not been recorded with a multi-camera angle system.

REPEAT

To Repeat a Chapter or Title

During playback, press "Repeat" button, the following symbols will be displayed on screen.

This Repeat button is used to repeat a chapter, title or a track.

- DVD



During playback, press " Repeat " button once to repeat current chapter.



During playback, press "Repeat" button twice to repeat the DVD disc.



During playback, press "Repeat" button three times to resume normal mode.

• CD/MP3



During playback, press "Repeat" button once to repeat current track.



During playback, press "Repeat" button twice to repeat the CD/MP3 disc.



During playback, press "Repeat" button three times to cancel repeat mode.

Repeat A-B

Repeat A-B lets you repeat a specific segment on the DVD that you define.



At the start of the segment you want to repeat, press the "Repeat A-B" button to mark the start (A) point.



When the picture plays to the end of the segment you want to mark, press "Repeat A-B" button to mark (B) point. Then the segment you set will plays repeatedly.



To turn Repeat A-B off, press "Repeat A-B" button to resume normal playback.

The Repeat A-B symbol remains on screen until Repeat A-B mode is canceled.

Zoom

The Zoom feature lets you magnify area within a picture up to 2X or 4X.

- During DVD's playback or freeze frame, press "Zoom" button to magnify picture up to 2X.
- Press Up/Down/Left/Right arrow button to select the area you want to magnify.
- Press "Zoom" button again to magnify the picture up to 4X.
- In the same way, press Up/Down/Left/Right arrow button to select the area you want to magnify.
- Press "Zoom" button again to cancel Zoom function.

PSCAN/NORMAL

Press (PSCAN/NORMAL) key to select Progressive Scan mode or Normal mode,

For Progressive scan function, make sure that your TV is connected through Component jack.

MODE

Press (MODE) key to select s-video, RGB or Y/Cb/Cr output.

Program

The Program playback option allows you to enter the order in which you want chapters to play. During DVD's playback, press "Program" button to bring up Program Menu.

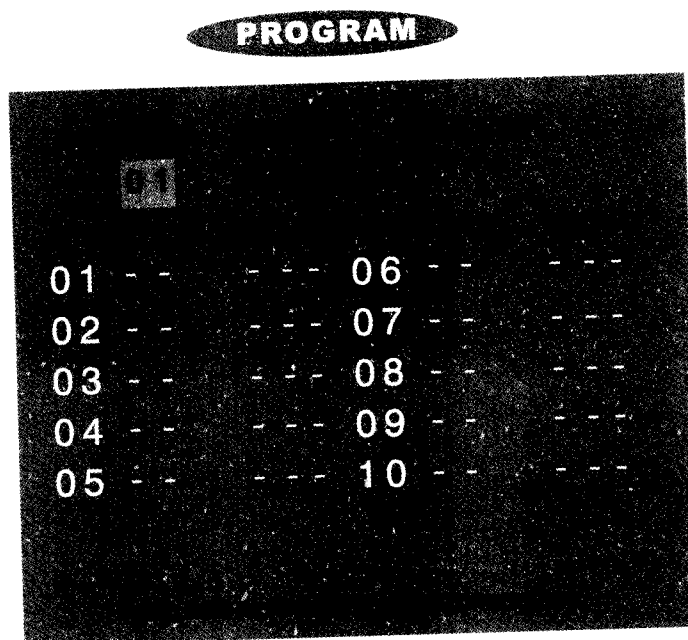

- Use number button to select a title, then select a chapter in the order you want them to play. (Refer to the picture above)
- Press "Enter" button to set your program, then press "Play" button to play the DVD in the order you have programmed.
- Press "Program" button again to close Program Menu.

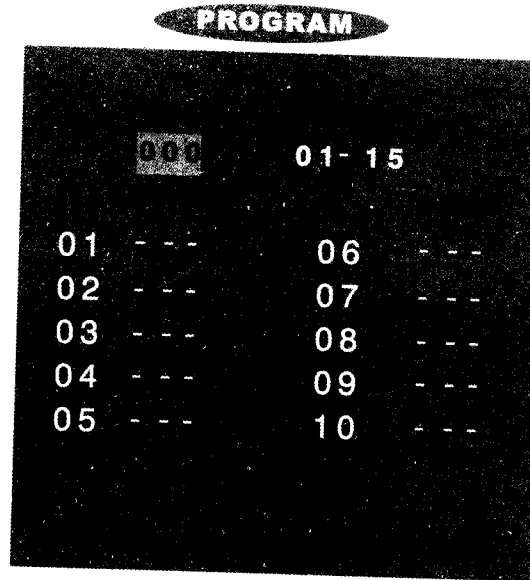

- Use Number button to choose Tracks.
- Press "Enter" button to set your program.
- Press "Play" button to play the DVD in the order you have programmed.
- Press "Program" button again to leave Program Menu.

Console Menu Description

During playback, press "Display" button to bring up Console Menu.

DVD Console

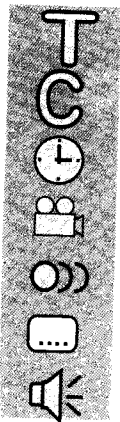

Function:

To display current Title/ select other Title

Way to select:

Left/Right arrow button/Number button + "Enter" button



Function:

To display current Chapter and other different destination Chapter

Way to select:

Left/Right arrow button/ Number button + "Enter" button

**Function:**

To display Elapsed Play Time / enter Time Menu

Way to select:

Number button + "Enter" button

**Function:**

To display current camera angle / change camera angle

Way to select:

Left/Right arrow button/"Angle" button

**Function:**

To display current audio language / change audio language

Way to select:

Left/Right arrow button/ " Language " button

**Function:**

To display current subtitle / change subtitle

Way to select:

Left/Right arrow button/"Subtitle" button

**Function:**

To display current speaker status (Left/ Right Select sound/Mute/Stereo mode)

Way to select:

Left/Right arrow button+"L/R" button

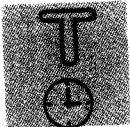
CD Console**Function:**

To display current Track and other different destination Track

Way to select:

Left/Right arrow button/ Numbe button + "Enter" button

**Function:**

To display Elapsed Play Time / enter Time Menu

Way to select:

Number button + "Enter" button

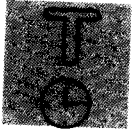
**Function:**

To display current Track no. and other different destination Track no.

Way to select:

Left/Right arrow button/ Number button + "Enter" button

**Function:**

To display Elapsed Play Time / enter Time Menu

Way to select:

Number button + "Enter" button

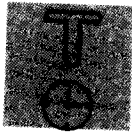
Picture CD Console**Function:**

To display current Picture and other different destination Picture.

Way to select:

Left/Right arrow button/ Number button + "Enter" button

4. Playing MP3

Normal Play

Load MP3 disc, and MP3 Directory Menu will appear on the screen. (see Picture below)

- Use Up/Down/Left/Right buttons to select the directory where the MP3 file you want to play exists, then press "Enter" button.
- Press Up/Down/Left/Right buttons to select the file in the directory.
- Press "Enter"/"Play" button to start playing.

Prompt message is shown on the button of the MP3 Directory Menu.

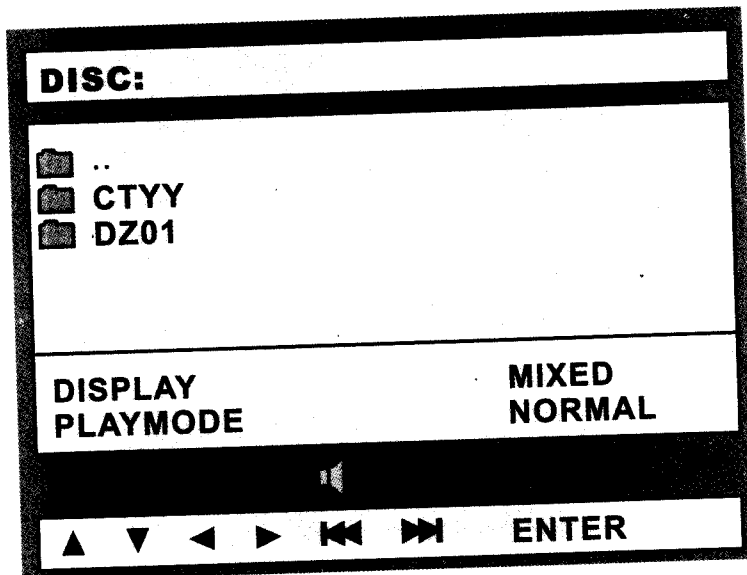

Programmed play

- During playback, press "Program" button to bring up Program Menu.
- Use Up/Down button to choose MP3 file, then press "Enter" button.
- Press Right button to select required MP3 files
- Press "Play" button to play in programmed order.

5. Playing JPEG

- The JPEG disc you load needs to conform to ISO9660 form.
- The Directory will automatically be displayed. Press Up/ Down/ Left/ Right buttons to move highlight and press "Enter" button to select.
- When the JPEG file you desire has been highlighted, press "Enter" button to start playback. During playback, the JPEG picture will be compressed according to its size.
- During playback, press " Previous/ Next" to select picture you need, or you can press "Display" to bring up Console Menu. Select "Title" item, press number buttons or arrow button to select desired pictures.

Picture Rotating

- Press Right button to rotate picture 90 degrees, press Down button can rotate picture 180 degrees, press Left button can rotate picture 270 degrees, and press Up button to restore picture's original size.
- Changing selected picture, the rotated picture will automatically restore its original direction.

6. DVD Player System Description

Setup Menu

Setup Menu Description

This menu can be used to choose audio language, subtitle language, and OSD language or DVD menu language. You need to use these items when you begin to play a DVD disc. When you start to play a DVD disc, the DVD player will automatically choose default language if the DVD player contains this language already.

- When DVD player is playing disc or stops, you can press “**SETUP**” button on the remote control to display the Setup Menu.
- Use ↑ Up/ ↓ Down ←Left/ → Right arrow buttons to change your setting.
- Press “**Enter**” button to confirm your setting.
- Press ↑ Up/ ↓ Down arrow buttons to select the item you want.
- After finishing your setting, you can choose “**SETUP**” to save&exit.

SYSTEM

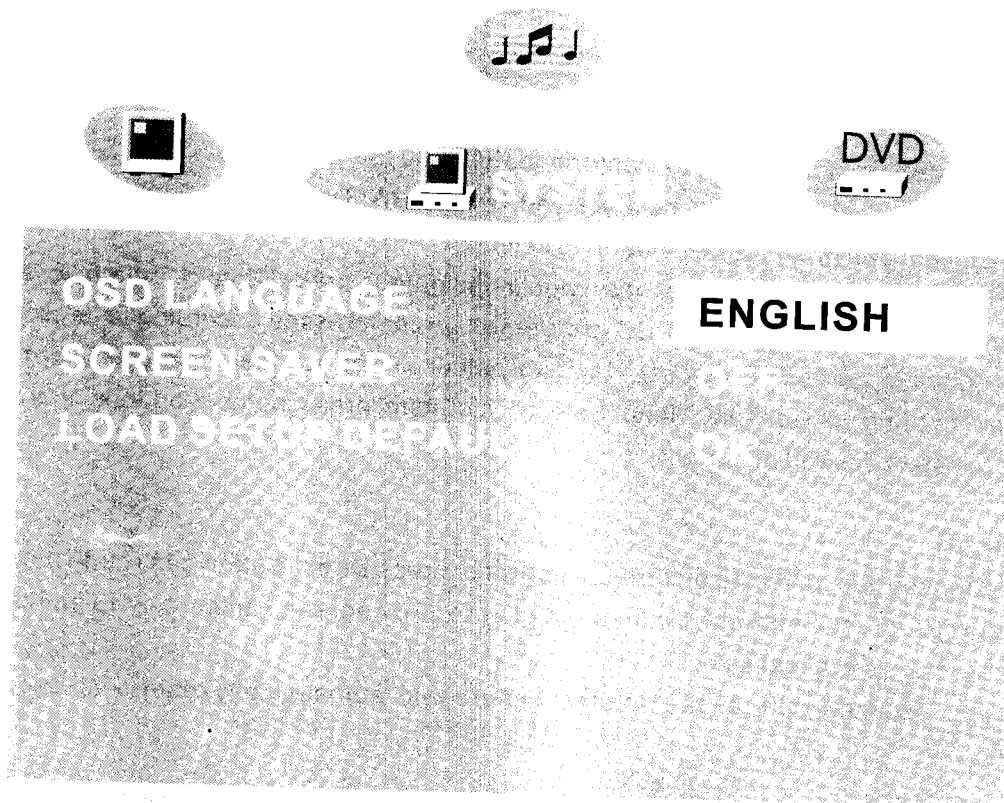

↑↓ : MOVE ⇐⇒ : SELECT ENTER: CONFIRM SETUP : SAVE & EXIT

OSD LANGUAGE

This item is used to select OSD(On-screen Display) language.

- Chinese
- English

SCREEN SAVER

This item is used to open/close Screen Saver. It includes

- Open Screen Saver will automatically execute if the screen is idle for three minutes.
- Close Screen Saver will not execute for any reason.

LOAD DEFAULT

This item is used to restore all menus to their factory defaults. Sub-tem:

- OK

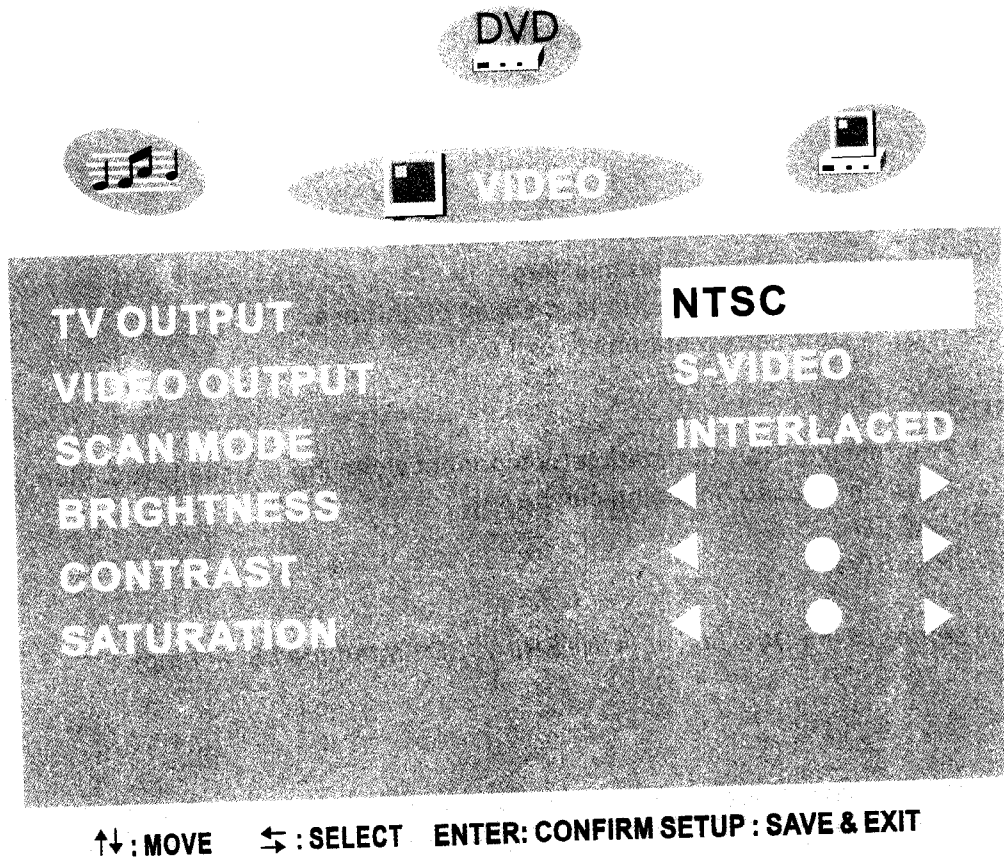
VIDEO Setup

VIDEO Setup (English) Menu

TV OUTPUT

This item is used to select a TV Signal System to match your TV set.

- AUTO
- NTSC
- PAL

Make sure you set this function for the correct TV system you are using.

VIDEO OUTPUT

You can select Video output format according to your requirement. They contains

- CVBS
- RGB
- Y/Cb/Cr
- S-VIDEO

BRIGHTNESS

This item is used to adjust the BRIGHTNESS of your screen

- Press “Enter “ button to enter this item
- Press ←Left/→Right arrow buttons to adjust brightness
- Press ↑ Up/ ↓ Down arrow buttons to exit

CONTRAST

This item is used to adjust the CONTRAST of your screen.

- Press “Enter “ button to enter this item
- Press Left/ Right arrow buttons to adjust brightness
- Press Up/Down arrow buttons to exit

SATURATION

This item is used to adjust the SATURATION of your screen.

- Press “Enter “ button to enter this item
- Press ←Left/ →Right arrow buttons to adjust brightness
- Press ↑ Up/ ↓ Down arrow buttons to exit

SCAN MODE

If your TV is Progressive Scan Compatible(component video input, usually red, blue, green. Progressive Scan/ Interlaced Scanning can be set:

- INTERLACED
- PROGRESSIVE

The default setting of the DVD player is INTERLACED (Interlaced Scanning).

AUDIO Setup

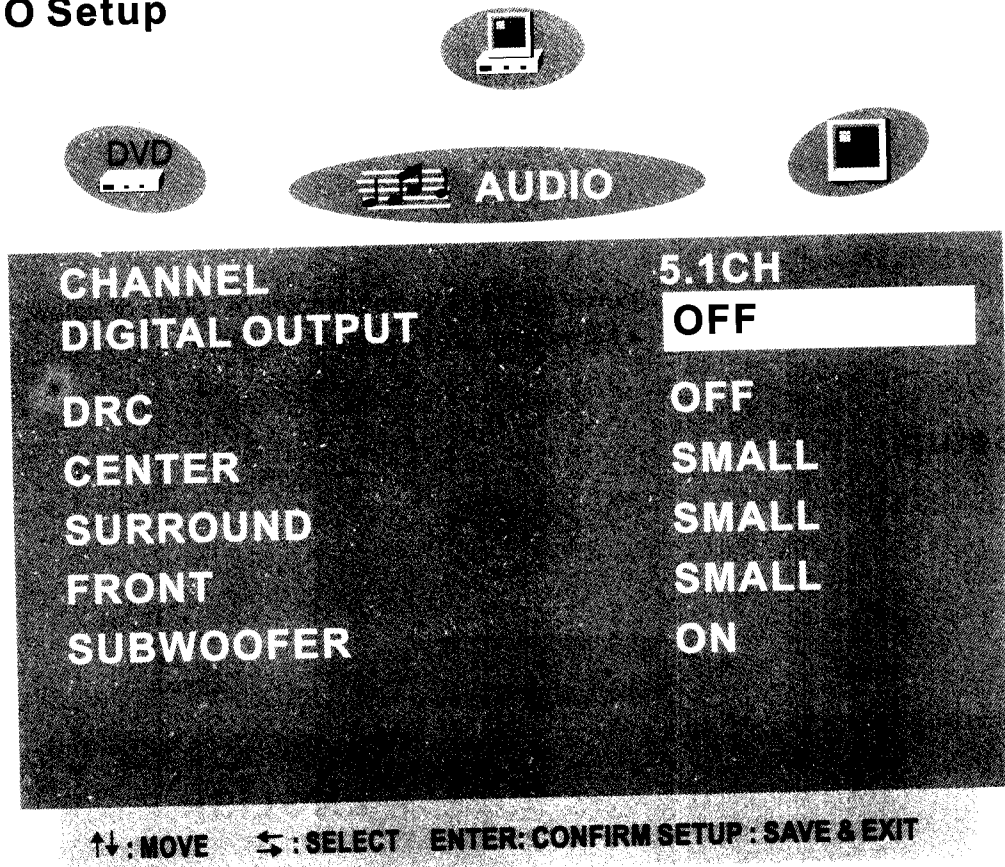

Audio Setup (English) Menu

DIGITAL OUTPUT

Each DVD disc has its own Audio Output options. You can setup the DVD's Digital Audio Output according to your speaker system. This item contains

- **OFF** Turn Digital Output off.
- **BITSTREAM** Select this option when connecting to an amplifier equipped with DTS decoder, Dolby Digital decoder and PCM decoder, or audio equipment with digital audio input terminals.
- **LPCM 48K** When the DVD player is connected with a 2-channel digital or stereo amplifier, please select this option.

CHANNEL

On Speaker Setup Menu, you can select audio output style to fit your audio output equipment:

- 5.1 CH: 5.1 channel output
- 2CH: 2 channel output

CEN&SURR

When 5.1 CH Surround Sound is played, this item is used to adjust the volume of Center and Surround speakers. It includes:

- LARGE
- SMALL
- OFF

DRC

This item can select dynamic range compress, it contains FULL, 1/2FULL, OFF three status.

SUBWOOFER

When 5.1 CH Surround Sound is played, this item is used to adjust the volume of Subwoofer. It includes:

- ON
- OFF

* IF you have connected the system to a speaker with low frequencies of 100Hz or below, select "LARGE".

* IF you have connected the system to a speaker without low frequencies of 100Hz or below, select "SMALL". But if you don't connect a subwoofer, always select "LARGE".

DVD Setup

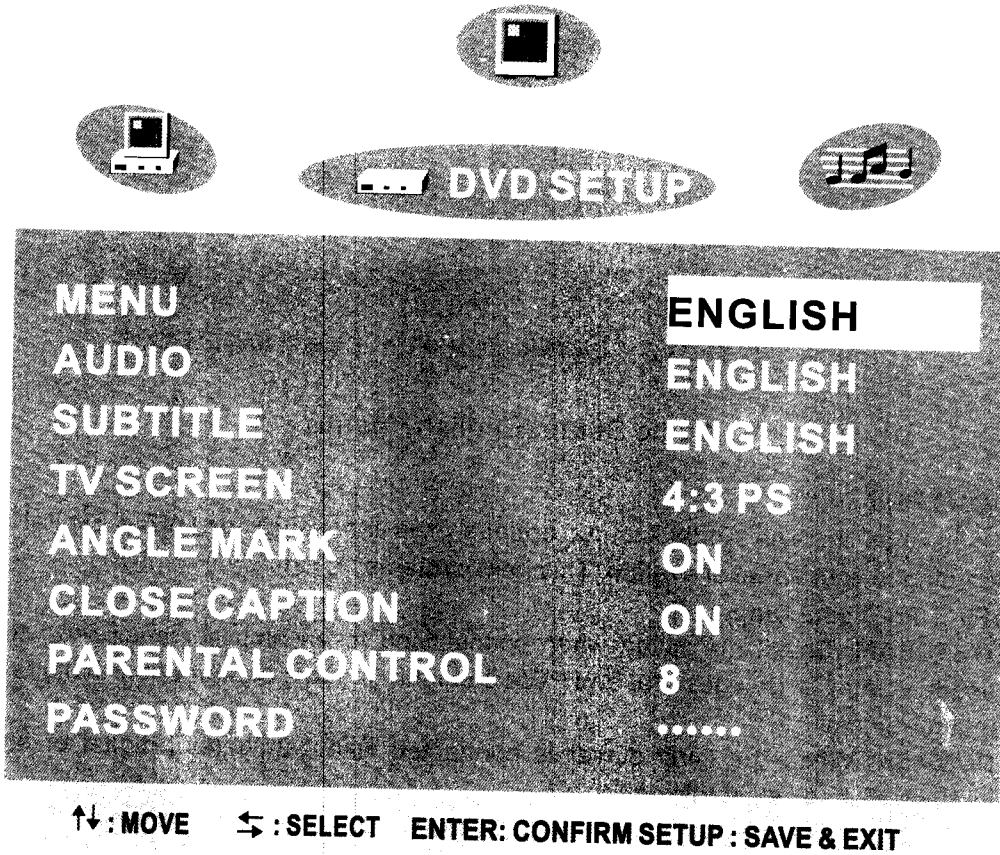

DVD Setup English Menu

MENU

When you begin to play a DVD disc, this player will automatically select its default audio language if the disc's default language is available among the following items.

- CHINESE
- ENGLISH
- FRENCH
- ITALIAN
- GERMAN
- SPANISH

AUDIO

When you begin to play a DVD disc, this player will automatically select its default audio language if the disc's default language is available among the following items.

- CHINESE
- ENGLISH
- FRENCH
- ITALIAN
- GERMAN
- SPANISH

SUBTITLE

When you begin to play a DVD disc, the default subtitle of this player will automatically be displayed if the disc's default subtitle is available among the following items.

- CHINESE
- ENGLISH
- FRENCH
- ITALIAN
- GERMAN
- SPANISH

TV SCREEN

How the picture formats appear on your TV depend on that kind of TV you have and the picture mode your TV is set to:

- 16:9 **Wide Screen** for wide screen TV (Full Mode)
- 4:3LB **Letter Box** refers to pictures where black bands appear at the top and bottom.
- 4:3PS **Pan and Scan** refers to pictures where part of the picture is cut off so it fills the whole screen.



16:9 Wide Screen



4:3 Letter Box



4:3 Pan and Scan

ANGLE MARK

Some DVDs contain multiple angles of a particular scene or sequence. This item includes

- ON When multiple camera angles are available, the symbol will be displayed on screen.
- OFF When multiple camera angles are available, the symbol will NOT be displayed on screen.

PARENTAL CONTROL

The Parental Control is a rating system, like movie ratings. This helps you control the types of DVDs that your family watches. For example, you could edit out violent scenes that are unsuitable for children.

- Enter a personal 4-digital security code.
- Press " Enter " button to select the parental control level.
- Press Up / Down arrow button to exit.

You cannot play DVD discs rated higher than the level you selected unless you cancel the parental control function.

Note: This feature work with DVD discs that have been assigned a rating.

Changing Parental Control Password

- Enter default 4-digital security code "8888" .
- Then enter new 4-digital security code.
- Re-enter to confirm your 4-digital security code.
- Press Up/Down arrow button to exit.

Note: New 4-digital security code will take effect after closing the Setup Menu.

7. KARAOKE FUNCTION

Connection of Microphone

Adjust the MIC VOL and MIC ECHO on the front panel to the minimum position, then insert the microphone into the MIC jack. You can insert two microphones at the same time.

Play Karaoke

- a. Press MIC key to turn on the karaoke function.
- b. Adjust the volume of microphone by VOL knob.
- c. Adjust the ECHO of karaoke by ECHO knob.
- d. Adjust the proportion of the volume of microphone and volume of the music to your satisfaction by VOL+、VOL- key.

Special Function of Karaoke

- a. Set the audio to STEREO
- b. Press the Karaoke key on the remote control, select Karaoke channel according different disc.

Note: This function is not available in DVD disc.

8. Troubleshooting

Before requesting service for this player, check the items below for a possible cause of the problem you are experiencing. Some simple checks or a minor adjustment on your part may eliminate the problem and restore proper operation.

PICTURE

NO PICTURE

Ensure that the equipment is connected properly.

Connect the video cable securely into the appropriate jacks.

Select the appropriate video input mode on the TV so the picture from the DVD video player appears on the TV screen.

Picture Distorted

The disc is dirty and needs to be cleaned.

It is normal for some distortion to appear while Fast Motion Playback.

Picture not Suit TV Screen

Change "TV SCREEN" setting in DVD Setup Menu to suit your television.

SOUND

NO SOUND

Check the connections.

Check the volume on the equipment you have connected.

Connect the audio cable securely into the appropriate jacks.

Ensure that the input settings for the television and stereo system are correct.

IF the player is in mute mode, please press "Mute" button again to turn on sound.

No Stereo Sound Effect when Playing Video or CD

Check the connections.

Press "Stereo" button to select stereo sound.

The Remote Control does not work properly.

Remove the obstacle existing between the DVD player and the remote control.

The remote control is too far from the DVD video player. Operate the remote control within operating distance.

Point the remote control at the remote sensor of the DVD video player.

If the batteries in the remote control are exhausted, please replace batteries with new ones.

The DVD player does not start playback.

No disc is inserted. ("No disc" symbol appears on the screen). Please insert disc.

The disc is placed upside down. Place the disc with the playback side down.

The disc is dirty. Please clean the disc.

If you are in doubt about some of the following items or if the remedies indicated in the chart do not solve the problem consult your local dealer for service.

Glossary

525 Lines Progressive Scan TV Compatible

Compared with standard interlaced scanning, Progressive Scan enables all 525 lines to be scanned at the exact same time. The result is a smoother and sharper picture, with high resolution and no motion artifacts. Compatible TVs can be connected to the DVD player via Component Video Out connector, then video signal can be set to Interlaced Scanning or Progressive Scan.

Bitstream

This is the digital form of multiple channel audio data (e.g. 5.1 channels) before it is decoded into its various channels.

Frame

Frames are the still pictures that go together to make a moving picture. There are about 30 frames shown each second.

Graphical Setup Navigator

You can easily set up DVD player's settings by Graphical Setup Navigator system. Graphical Setup Navigator can help you to setup DVD player's audio, video, language, KARAOKE, and system setup.

Playback Control

If a Video CD has "playback control" written on it or its jacket, it means that particular scene or information can be selected for viewing interactively with the television using the menu screen. This unit can play Video CD with playback control.

Title/Chapter/Track

Normally, DVD Video discs are divided into titles, and titles are sub-divided into chapters so that you can quickly locate any specific titles or chapters. However, audio CDs are divided into many tracks.

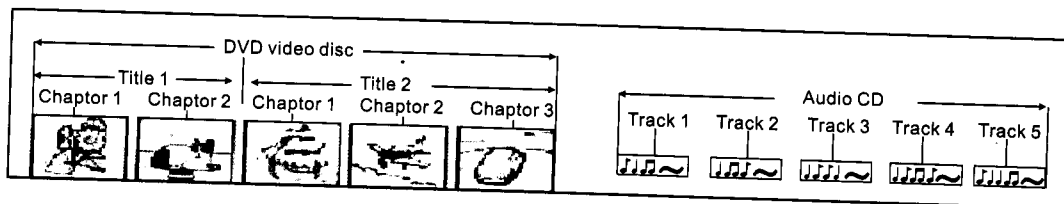

DTS

Digital Theatre System originally produced digital audio tracks for motion pictures. A version of this format adapted for consumer video and audio products is referred to as DTS Entertainment. Like Dolby Digital it provides five full-frequency range channels (Left, center, right, left surround, and right surround) and an additional Low Frequency Effect (LFE) channel.

9. Technical Specification

Type	DVD PLAYER
Model	DVD-615
Play mode	NTSC/PAL/AUTO
Disc mode	DVD, CD, MP3, CD-R, CD-RW, Picture-CD,
Video characteristic	
Resolution	≥500 lines
Video S/N ratio	≥56dB
Audio characteristic	
Frequency response	fs 96KHz: 20Hz-20KHz: +/-1dB
Audio S/N ratio	≥ 90dB
Dynamic range	≥90dB
Distortion	<0.01%
D/A converter	96 KHz/24bit
Output characteristic	
Video output	1Vp-p(75 Ω)
S-Video output	Y: 1Vp-p(75 Ω) C: 0.3Vp-p(75 Ω)
Audio output	2.0V ± $\begin{matrix} 0.0V \\ 1.0V \end{matrix}$
Digital audio output	Coaxial optical
Power Voltage	AC 100V-240V ~ 50/60Hz
Power consumption	≤25W
Size	430x43x270mm
Weight	3.8Kg

Specifications are subject to change without notice.

