

KENWOOD

DUAL DIN SIZED CD/CASSETTE RECEIVER

DPX-MP4100

INSTRUCTION MANUAL

Kenwood Corporation



Contents

Safety precautions	3	CD/Audio file/External disc control features	16
Notes	4	Playing CD & Audio file	
General features	6	Playing External Disc	
Power		Fast Forwarding and Reversing	
Selecting the Source		Track/File Search	
Volume		Disc Search / Folder Search	
Attenuator		Direct Music Search	
System Q		Direct Disc Search	
Audio Control		Track/File/Disc/Folder Repeat	
Adjusting the detail of Audio Control		Scan Play	
Audio Setup		Random Play	
Speaker Setting		Magazine Random Play	
SRS WOW Select		Folder Select	
SRS WOW Control		Text/Title Scroll	
Subwoofer Output			
Switching Display		Menu system	20
Spectrum Analyzer Select		Menu System	
Station/Disc Naming (SNPS/DNPS)		Activating Security Code	
TEL Mute		Deactivating Security Code	
Tuner features	12	Touch Sensor Tone	
Tuning		Contrast Adjustment	
Direct Access Tuning		Manual Clock Adjustment	
Station Preset Memory		Switching preout	
Auto Memory Entry		Opening Demonstration	
Preset Tuning		Built-in Amp Setting	
Frequency Step Setting		Built-in Auxiliary input Setting	
Cassette player features	14	CD Read Setting	
Playing Cassette Tapes		DSI (Disabled System Indicator)	
Fast Forwarding and Rewinding		Dual Zone System Setting	
Dolby B NR		B.M.S. (Bass Management System)	
Selecting the Tape type		B.M.S. Frequency Offset	
DPSS (Direct Program Search System)		CRSC (Clean Reception System Circuit)	
DPSS with the Remote control		Auxiliary Input Display Setting & Station/Disc Naming	
Blank Skip		Text Scroll	
Music Repeat		Tuning Mode	
Index Scan		Auto Memory Entry	
		Supreme Setting	
		Basic Operations of remote control	25
		Accessories/ Installation Procedure	27
		Connecting Wires to Terminals	28
		Installation	29
		Troubleshooting Guide	30
		Specifications	32

Safety precautions

⚠ WARNING

To prevent injury or fire, take the following precautions:

- To prevent a short circuit, never put or leave any metallic objects (such as coins or metal tools) inside the unit.
- Mounting and wiring this product requires skills and experience. For safety's sake, leave the mounting and wiring work to professionals.

⚠ CAUTION

To prevent damage to the machine, take the following precautions:

- Make sure to ground the unit to a negative 12V DC power supply.
- Do not install the unit in a spot exposed to direct sunlight or excessive heat or humidity. Also avoid places with too much dust or the possibility of water splashing.
- When replacing a fuse, only use a new fuse with the prescribed rating. Using a fuse with the wrong rating may cause your unit to malfunction.
- Do not use your own screws. Use only the screws provided. If you use the wrong screws, you could damage the unit.

Do Not Load 8 cm (3 in.) CDs in the CD slot

If you try to load a 8 cm (3 in.) CD with its adapter into the unit, the adapter might separate from the CD and damage the unit.

About CD players/disc changers connected to this unit

Kenwood disc changers/ CD players released in 1998 or later can be connected to this unit.

Refer to the catalog or consult your Kenwood dealer for connectable models of disc changers/ CD players. Note that any Kenwood disc changers/ CD players released in 1997 or earlier and disc changers made by other makers cannot be connected to this unit. Connecting unsupported disc changers/CD players to this unit may result in damage.

Set the "O-N" Switch to the "N" position for the applicable Kenwood disc changers/ CD players.

The functions you can use and the information that can be displayed may differ depending on the models being connected.



- You can damage both your unit and the CD changer if you connect them incorrectly.

Lens Fogging

When you turn on the car heater in cold weather, dew or condensation may form on the lens in the CD player of the unit. Called lens fogging, this condensation on the lens may not allow CDs to play. In such a situation, remove the disc and wait for the condensation to evaporate. If the unit still does not operate normally after a while, consult your Kenwood dealer.

WOW, SRS and  symbol are trademarks of SRS Labs, Inc.
WOW technology is incorporated under license from SRS Labs, Inc.

The "AAC" logo is trademark of Dolby Laboratories.

Notes

- If you experience problems during installation, consult your Kenwood dealer.
- When you purchase optional accessories, check with your Kenwood dealer to make sure that they work with your model and in your area.
- Characters in the LCD may become difficult to read in temperatures below 5 °C (41 °F).
- The characters conforming to ISO 8859-1 character set can be displayed.
- The illustrations of the display and the panel appearing in this manual are examples used to explain more clearly how the controls are used. Therefore, what appears on the display in the illustrations may differ from what appears on the display on the actual equipment, and some of the illustrations on the display may be inapplicable.

How to reset your unit

- If the unit fails to operate properly, press the Reset button. The unit returns to factory settings when the Reset button is pressed.
- Press the reset button if the disc auto changer fails to operate correctly. Normal operation should be restored.

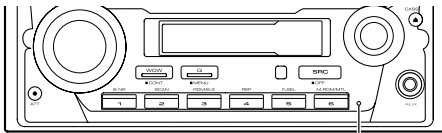

Reset button

Cleaning the Unit

If the faceplate of this unit is stained, wipe it with a dry soft cloth such as a silicon cloth.

If the faceplate is stained badly, wipe the stain off with a cloth moistened with neutral cleaner, then wipe it again with a clean soft dry cloth.



- Applying spray cleaner directly to the unit may affect its mechanical parts. Wiping the faceplate with a hard cloth or using a volatile liquid such as thinner or alcohol may scratch the surface or erase characters.

About Cassette tape Cleaning the tape head

When there's noise or the sound quality is bad during tape play the tape head maybe dirty, clean the tape head.

About Cassette tape

- If the tape is slack tighten it.
- If the cassette tape label is peeling off glue it on again.
- Don't use deformed cassette tape.
- Don't place cassette tape on the dashboard etc. where the temperature is high.
- Don't use cassette tape that's 100 minutes long or longer.

The marking of products using lasers (Except for some areas)

**CLASS 1
LASER PRODUCT**

The label is attached to the chassis/case and says that the component uses laser beams that have been classified as Class 1. This means that the unit is utilizing laser beams that are of a weaker class. There is no danger of hazardous radiation outside the unit

About Audio file

• Playable Audio file

AAC (.m4a), MP3 (.mp3), WMA (.wma)

• Playable disc media

CD-R/RW/ROM

• Playable disc file format

ISO 9660 Level 1/2, Joliet, Romeo, Long file name.

Although the audio files are complied with the standards listed above, the play maybe impossible depending on the types or conditions of media or device.

• Playing order of the Audio file

In the example of folder/file tree shown below, the files are played in the order from ① to ⑩.

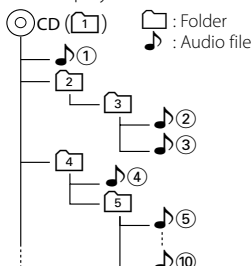

An online manual about audio files is put on the site, www.kenwood.com/audiofile/. On this online manual, detailed information and notes which are not written in this manual are provided. Make sure to read through the online manual as well.

Handling CDs

- Do not touch the recording surface of the CD.
- Do not stick tape etc. on the CD, or use a CD with tape stuck on it.
- Do not use disc type accessories.
- Clean from the center of the disc and move outward.
- When removing CDs from this unit, pull them out horizontally.
- If the CD center hole or outside rim has burrs, use the CD only after removing the burrs with a ballpoint pen etc.

CDs that cannot be used

- CDs that are not round cannot be used.

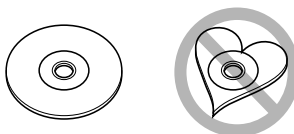

- CDs with coloring on the recording surface or CDs that are dirty cannot be used.
- This unit can only play the CDs with 

This unit may not correctly play discs which do not have the mark.

- You cannot play a CD-R or CD-RW that has not been finalized. (For the finalization process refer to your CD-R/CD-RW writing software, and your CD-R/CD-RW recorder instruction manual.)

General features

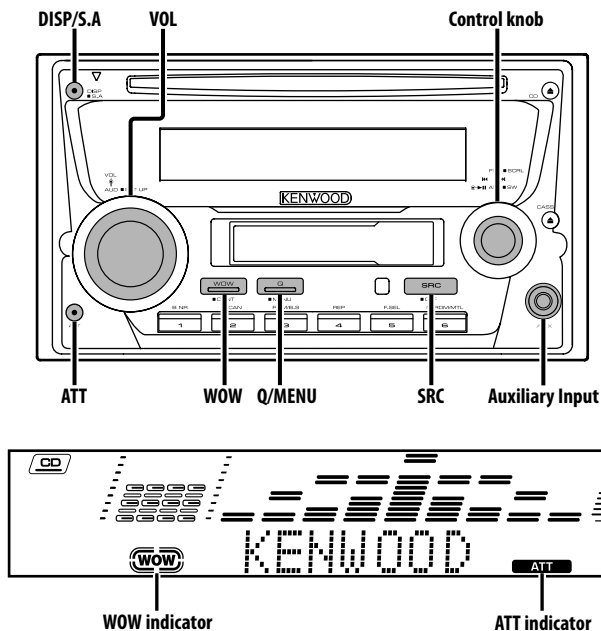

Power

Turning ON the Power

Press the [SRC] button.

Turning OFF the Power

Press the [SRC] button for at least 1 second.

Selecting the Source

Press the [SRC] button.

Source required	Display
Tuner	"TUNER"
Tape	"TAPE"
CD	"CD"
External disc (Optional accessory)	"CD CH"
Auxiliary input*	"AUX"
Auxiliary input (Optional accessory)	"AUX EXT"
Standby (Illumination only mode)	"STANDBY"

* An equipment such as a portable audio player can be connected to the auxiliary input terminal using a commercially available mini-plug (3.5 ϕ).



- Use the mini-plug which is stereo type and does not have any resistance.

Volume

Increasing Volume

Turn the [VOL] knob clockwise.

Decreasing Volume

Turn the [VOL] knob counterclockwise.



- Volume adjustment range gets narrower when "V-OFF" is selected in <Audio Setup> (page 8).

Attenuator

Turning the volume down quickly.

Press the [ATT] button.

Each time you press the button, the Attenuator turns ON and OFF.

When the Attenuator is ON, the "ATT" indicator blinks.

System Q

Selecting the best sound setting preset for different types of music.

1 Select the source to set

Press the [SRC] button.

2 Select the Sound type

Press the [Q] button.

Each time you press the button, the sound setting alternates.

Sound setting	Display
Natural	"NATURAL"
User memory	"USER"
Rock	"ROCK"
Pops	"POPS"
Easy	"EASY"
Top 40	"TOP40"
Jazz	"JAZZ"



- User memory: The values set on the <Audio Control> (page 7).
- Change each setting value with the <Speaker Setting> (page 9).
First, select the speaker type with the Speaker setting.

Audio Control

1 Select the source to adjust

Press the [SRC] button.

2 Enter Audio Control mode

Press the [VOL] knob.

"AUD mode" is displayed.

3 Select the Audio item to adjust

Press the [VOL] knob.

Each time you press the knob, the item to be adjusted alternates between the items shown in the table below.

4 Adjust the Audio item

Turn the [VOL] knob.

Adjustment Item	Display	Range
Rear Volume	"R-VOL"	0 — 35
Subwoofer level	"SubW"	-15 — +15
Bass level	"BasLV"	-8 — +8
Middle level	"MidLV"	-8 — +8
Treble level	"TreLV"	-8 — +8
Balance	"BAL"	Left 15 — Right 15
Fader	"FAD"	Rear 15 — Front 15

Exit Audio Control mode (Volume control mode)

5 Exit Audio Control mode

Press any button.

Press a button other than the [VOL] knob, [SRC], [▲] and [ATT] button.

Adjusting the detail of Audio Control

Among the Basic Audio items, you can adjust the Bass level, Middle level, and Treble level in detail.

1 Select the Basic Audio item

Select the desired item to be set in detail from followings;

- Bass level
- Middle level
- Treble level

For how to select Basic Audio items, see <Audio Control> (page 7).

2 Enter Detail adjustment mode of Audio Control

Press the [VOL] knob for at least 1 second.

3 Select the Detail Audio item to adjust

Press the [VOL] knob.

Each time you press the knob, the item to be adjusted alternates between the items shown in the table below.

Next page ►

General features

4 Adjust the Detail Audio item

Turn the [VOL] knob.

Bass level

Adjustment Item	Display	Range
Bass Center Frequency	"BasF"	40/50/60/70/80/100/120/150 Hz
Bass Q Factor	"BasQ"	1.00/1.25/1.50/2.00
Bass Extend	"B EX"	ON/OFF

Middle level

Adjustment Item	Display	Range
Middle Center Frequency	"MidF"	0.5/1.0/1.5/2.0 kHz
Middle Q Factor	"MidQ"	1.0/2.0

Treble level

Adjustment Item	Display	Range
Treble Center Frequency	"Tref"	10.0/12.5/15.0/17.5 kHz

5 Exit the Detail Audio Control mode

Press the [VOL] knob for at least 1 second.



- When you set the Bass Extend to ON, low frequency response is extended by 20%.
- You can exit the Audio Control mode at anytime by pressing any button except for [VOL] and [ATT] buttons.

Audio Setup

Setting the Sound system, such as Cross over Network.

1 Select the source to adjust

Press the [SRC] button.

2 Enter Audio Setup mode

Press the [VOL] knob for at least 1 second.

3 Select the Audio Setup item to adjust

Press the [VOL] knob.

Each time you press the knob, the item to be adjusted alternates between the items shown in the table below.

4 Setup the Audio item

Turn the [VOL] knob.

Adjustment Item	Display	Range
Front High Pass Filter	"HPF"	Through/40/60/80/100/120/150/180/220 Hz
Rear High Pass Filter	"HPR"	Through/40/60/80/100/120/150/180/220 Hz
Low Pass Filter	"LPF"	50/60/80/100/120/Through Hz
Subwoofer Phase	"PHAS"	Normal (0°)/ Reverse (180°)
Volume offset	"V-OFF"	-8 — ±0 (AUX: -8 — +8)
Loudness	"LOUD"	ON/OFF
Dual Zone System	"ZZON"	ON/OFF



- Volume offset: Sets each source's volume as a difference from the basic volume.
- Loudness: Compensates for low and high tones during low volume. (Only the low tone is compensated for when the tuner is selected as a source.)
- Dual Zone System
Main source and sub source (Auxiliary input) output Front channel and Rear channel separately.
 - Set up the channel of sub source by <Dual Zone System Setting> (page 23).
 - Select Main source by [SRC] button.
 - Adjust the volume of Front channel by [VOL] knob.
 - Adjust the volume of Rear channel by <Audio Control> (page 7).
 - The Audio Control has no effect on sub source.
- You can use the Dual Zone System with the internal auxiliary input.

5 Exit Audio Setup mode

Press any button.

Press a button other than the [VOL] knob, [SRC], [▲] and [ATT] button.

Speaker Setting

Fine-tuning so that the System Q value is optimal when setting the speaker type.

1 Enter Standby

Press the [SRC] button.

Select the "STANDBY" display.

2 Enter Speaker Setting mode

Press the [VOL] knob.

3 Select the Speaker type

Turn the [VOL] knob.

Each time you turn the knob, the setting alternates between the settings shown in the table below.

Speaker type	Display
OFF	"SP OFF"
For 5 & 4 in. speaker	"SP 5/4"
For 6 & 6x9 in. speaker	"SP 6*9/6"
For the OEM speaker	"SP OEM"

4 Exit Speaker Setting mode

Press the [VOL] knob.

SRS WOW Select

You can play back adding gorgeous heavy bass to the sound and making a 3D sound field.

1 Enter the WOW Select mode

Press the [WOW] button.

"WOW SEL" is displayed.

2 Select the WOW item

Press the [WOW] button.

Each time the button is pressed, the SRS WOW Select switch as shown below:

SRS WOW	Display
Moves the sound image up a notch and adjusts bass and the sound field.	"WOW Low"
Moves the sound image up two notches and adjusts bass and the sound field.	"WOW High"
Changes to the value set in 'SRS WOW Control'.	"WOW User"
Returns to the normal sound without SRS WOW.	"WOW Off"

When you set "WOW Low", "WOW High", or "WOW User", the SRS WOW function is ON.

When the SRS WOW is ON, the "WOW" indicator is ON.



- When operation stops for 3 seconds, the SRS WOW Select closes.
- WOW: TruBass, FOCUS and SRS 3D are all set to values shown below.

SRS WOW	SRS FOCUS	SRS TruBass	SRS 3D
High	High	On	On
Low	Low	On	On
Off	Off	Off	Off

SRS WOW Control

Adjusts each function of SRS WOW individually.

1 Enter the WOW Control mode

Press the [WOW] button for at least 1 second.

"WOW CTRL" is displayed.

2 Select the WOW item for adjustment

Push the Control knob towards up or down.

Each time the button is pressed, the items that can be adjusted switch as shown below.

3 Adjust the WOW item

Push the Control knob towards right or left.

Adjustment Item	Display	Range
SRS FOCUS setting	"FOCUS"	0(Off)/1(Low)/2(High)
SRS TruBass setting	"TB"	OFF/ON
SRS 3D setting	"SRS"	OFF/ON

4 Exit the WOW Control mode

Press the [WOW] button.



- TruBass: Assisting the playback for the super bass sound.
- FOCUS: Adjusts the sound image by changing the vertical position of the speakers virtually and increases or decreases the soundscape.
- SRS 3D: Making a natural 3D sound field.
- SRS 3D cannot be set in tuner source.

General features

Subwoofer Output

Turning the Subwoofer output ON or OFF.

Push the Control knob toward down for at least 2 seconds.

Each time you push the knob, Subwoofer output switches ON and OFF.

When it is ON, "SubW ON" is displayed.

Switching Display

Changing the information displayed.

Press the [DISP] button.

Each time the button is pressed the display switches as shown below.

In Tuner source

Information	Display
Frequency	
Station name or Frequency	"SNPS"
Character	
Clock	

In CD & External disc source

Information	Display
Play time	
Disc name	"DNPS"
Disc title	"D-Title"
Track title	"T-Title"
Character	
Clock	

In Audio file source

Information	Display
Play time	
Folder name	"Folder"
File name	"File"
Music title	"Title"
Album name	"Album"
Character	
Clock	

In Tape source

Information	Display
Play side & Tape counter	
Character	
Clock	

In Auxiliary input source

Information
Auxiliary input name
Character
Clock

In Standby mode

Information
Character & Graphic
Clock & Graphic
Clock



- If the selected display item does not have any information, alternative information is displayed.
- Album name cannot be displayed in WMA file.

Spectrum Analyzer Select

Selecting the Spectrum Analyzer display.

1 Enter the Spectrum Analyzer Select mode

Press the [S.A] button for at least 1 second.

"SPANANA" is displayed.

2 Select the Spectrum Analyzer

Press the [S.A] button.

Each time the button is pressed, the Spectrum Analyzers switch as shown below:

Spectrum Analyzer	Display
Scan of Spectrum Analyzer	"S.A Scan"
Peak Hold	"PeakHold"
Spectrum Analyzer 1	"SPANANA 1"
:	:
Spectrum Analyzer 7	"SPANANA 7"
Spectrum Analyzer off	"S.A OFF"



- Scan of Spectrum Analyzer:
The items from "PeakHold" to "SPANANA 7" are displayed in sequence.

3 Exit the Spectrum Analyzer Select mode

Press the [S.A] button for at least 1 second.

When operation stops for 10 seconds, Spectrum Analyzer at that time is registered and the Analyzer Select mode automatically closes.

Station/Disc Naming (SNPS/DNPS)

Attaching a title to a Station or CD.

1 Receive/play the station/disc you want to attach a title to



- A title cannot be attached to MD or Audio file media.

2 Enter Menu mode

Press the [MENU] button for at least 1 second.

"Menu" is displayed.

3 Select Name set mode

Push the Control knob towards up or down.

Select the "Name Set" display.

4 Enter Name set mode

Press the Control knob for at least 2 second.

5 Move the cursor to the enter character position

Push the Control knob towards right or left.

6 Select the character type

Press the Control knob.

Each time you press the knob, the character type alternates between the types shown in the table below.

Character type
Alphabet upper case
Alphabet lower case

7 Select the characters

Push the Control knob towards up or down.



- Enter characters by using a remote control with numbers buttons.

Example: If you are entering "DANCE".

Character	Button	Times pressed
"D"	[3]	1
"A"	[2]	1
"N"	[6]	2
"C"	[2]	3
"E"	[3]	2

8 Repeat steps 5 through 7 and enter the name.

9 Exit Menu mode

Press the [MENU] button.



- When operation stops for 10 seconds the name at that time is registered, and Name Set mode closes.
- Memory numbers
 - Tuner: 30 stations
 - Internal CD player: 10 discs
 - External CD changer/ player: Varies according to the CD changer/ player. Refer to the CD changer/ player manual.
- Change the title of station/CD by the same operation used to name it.

TEL Mute

The audio system automatically mutes when a call comes in.

When a call comes in

"CALL" is displayed.

The audio system pauses.

Listening to the audio during a call

Press the [SRC] button.

The "CALL" display disappears and the audio system comes back ON.

When the call ends

Hang up the phone.

The "CALL" display disappears and the audio system comes back ON.



- To use the TEL Mute feature, you need to hook up the MUTE wire to your telephone using a commercial telephone accessory. Refer to <Connecting Wires to Terminals> (page 28).

Tuner features

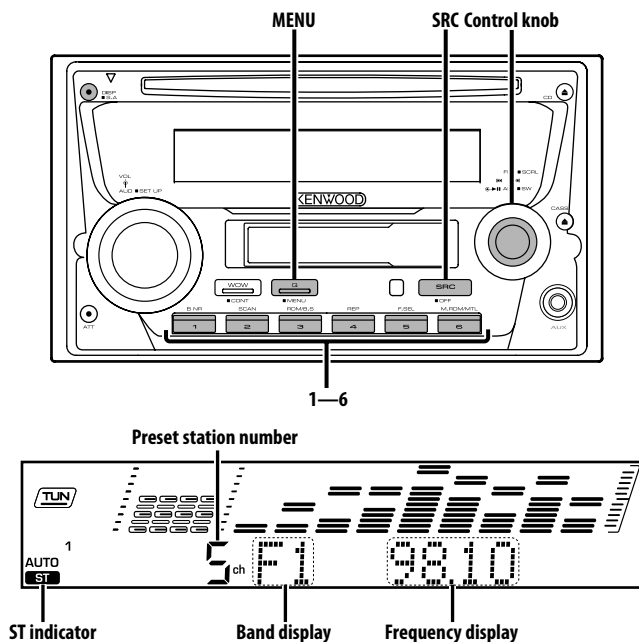

Tuning

Selecting the station.

1 Select tuner source

Press the [SRC] button.

Select the "TUNER" display.

2 Select the band

Push the Control knob towards [FM] or [AM].

Each time you push the knob toward [FM], it switches between the FM1, FM2, and FM3 bands.

3 Tune up or down band

Push the Control knob towards [◀◀] or [▶▶].



- During reception of stereo stations the "ST" indicator is ON.

Function of remote control

Direct Access Tuning

Entering the frequency and tuning.

1 Select the band

Press the [FM] or [AM] button.

2 Enter Direct Access Tuning mode

Press the [DIRECT] button on the remote control.

"- - - -" is displayed.

3 Enter the frequency

Press the number buttons on the remote control.

Example:

Desired frequency	Press button
92.1 MHz (FM)	[0], [9], [2], [1]
810 kHz (AM)	[0], [8], [1], [0]

Canceling Direct Access Tuning

Press the [DIRECT] button on the remote control.



- You can enter the FM band frequency in steps of a minimum of 0.1 MHz.

Station Preset Memory

Putting a station in the memory.

1 Select the band

Push the Control knob towards [FM] or [AM].

2 Select the frequency to put in the memory

Push the Control knob towards [◀◀] or [▶▶].

3 Put the frequency in the memory

Press the desired [1] — [6] button for at least 2 seconds.

The preset number display blinks 1 time.

On each band, 1 station can be put in the memory on each [1] — [6] button.

Auto Memory Entry

Putting stations with good reception in the memory automatically.

1 Select the band for Auto Memory Entry

Push the Control knob towards [FM] or [AM].

2 Enter Menu mode

Press the [MENU] button for at least 1 second.

"Menu" is displayed.

3 Select the Auto Memory Entry mode

Push the Control knob towards [FM] or [AM].

Select the "A-Memory" display.

4 Open Auto Memory Entry

Hold down on right or left of the Control knob for at least 2 seconds.

When 6 stations that can be received are put in the memory, Auto Memory Entry closes.

Preset Tuning

Recalling the stations in the memory.

1 Select the band

Push the Control knob towards [FM] or [AM].

2 Recall the station

Press the desired [1] — [6] button.

Frequency Step Setting

Changing the tuning frequency step.

The original setting is FM band 50 kHz, and AM band 9 kHz.

1 Turn the power OFF

Press the [SRC] button for at least 1 second.

2 Switch the frequency step

While pressing the [1] and [5] buttons, press the [SRC] button.

Release your fingers from the button after the display appears.

The frequency step changes to FM band 200 kHz, and AM band 10 kHz.



- When the same operation is repeated, the frequency step returns to the original setting.
- When the frequency step is changed, the frequencies in the memory are deleted.

Cassette player features

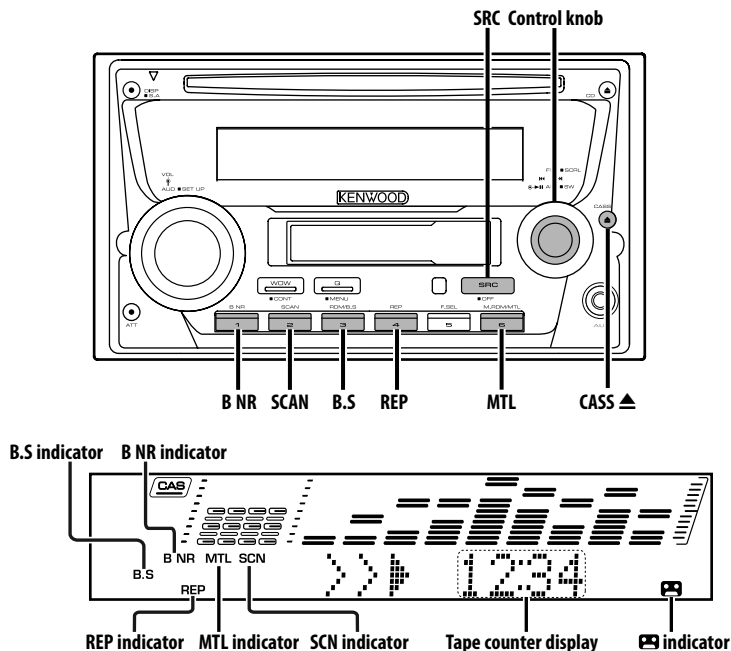

Playing Cassette Tapes

When the Cassette Tape is inserted

Press the [SRC] button.

Select the "TAPE" display.



- When there is a Cassette Tape inserted, the  indicator is ON.

When you want to listen to the reverse side

Press the Control knob.

Eject the Cassette Tape

Press the [CASS ▲] button.

Fast Forwarding and Rewinding

Fast Forwarding

Push the Control knob toward up.

When you press the Control knob, the fast forwarding stops.

Rewinding

Push the Control knob toward down.

When you press the Control knob, the rewinding stops.

Dolby B NR

Press the [B NR] button.

Each time you press the button, the Dolby B NR turns ON and OFF.

When Dolby B NR is ON, "B-NR ON" is displayed.

Selecting the Tape type

Press the [MTL] button.

Each time you press the button, the Tape type alternates between the tape types shown in the table below.

Tape type	Display
CrO ₂ (Type II), FeCr (Type III), Metal (Type IV)	"MTL ON"
Normal (Type I)	"MTL OFF"

DPSS (Direct Program Search System)

Indicating the music to skip, and Fast Forwarding or Rewinding.

Skipping to a later music

Push the Control knob toward [▶▶].

Each time you push the knob toward [▶▶], the number of music skipped increases.

Skipping to a previous music

Push the Control knob toward [◀◀].

Each time you push the knob toward [◀◀], the number of music skipped increases.

Cancelling DPSS

Press the Control knob.



- Space between music and the first 5 seconds of the music are recognized as the previous music.
- As many as 9 music can be skipped.

DPSS with the Remote control

Designating the music to be skipped with the remote control number buttons.

1 Designate the music to skip

Press number buttons on the remote.

2 Skipping to a later music

Press the [▶▶] button.

Skipping to a previous music

Press the [◀◀] button.

Cancelling DPSS

Press the [▶II] button.



- Space between music and the first 5 seconds of the music are recognized as the previous music.
- As many as 9 music can be skipped.

Blank Skip

Fast forwarding automatically when an unrecorded portion continues for at least 10 seconds.

Press the [B.S] button.

Each time you press the button, the Blank Skip turns ON and OFF.

When the Blank Skip is ON, "B.S ON" is displayed.

Music Repeat

Repeating the present music.

Press the [REP] button.

Each time you press the button, the Music Repeat turns ON and OFF.

When the Music Repeat is ON, "Repeat" is displayed.

Index Scan

Playing the first part of each music on the tape you are listening to and searching for the music you want to listen to.

1 Start Index Scan

Press the [SCAN] button.

"IDX Scan" is displayed.

2 Release it when the music you want to listen to is played

Press the [SCAN] button.

CD/Audio file/External disc control features

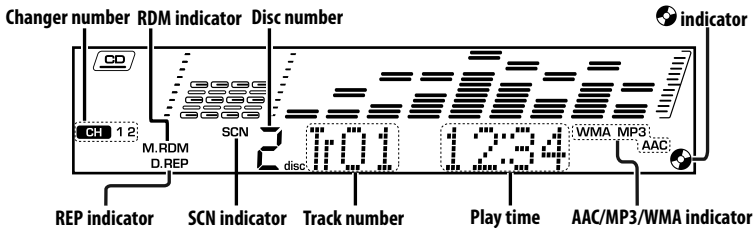
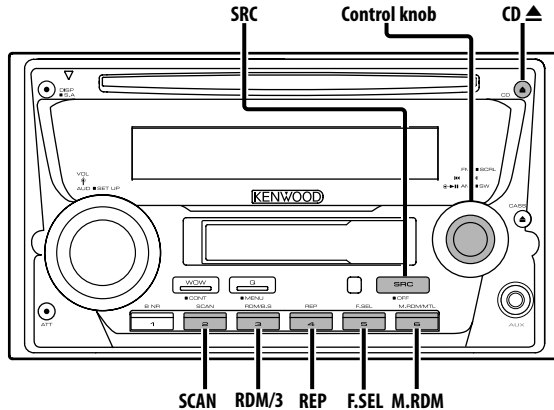

Playing CD & Audio file

When a disc is inserted

Press the [SRC] button.

Select the "CD" display.



- When a CD is inserted, the indicator is ON.

Pause and play

Press the Control knob.

Each time you press the knob, the audio pauses or plays.

Eject the CD

Press the [CD▲] button.



- Refer to <About Audio file> (page 5) for the Audio file by models you can play.
- During AAC is playing, the "AAC" indicator is ON.
- During MP3 is playing, the "MP3" indicator is ON.
- During WMA is playing, the "WMA" indicator is ON.

Playing External Disc

Playing discs set in the optional accessory disc player connected to this unit.

Press the [SRC] button.

Select the display for the disc player you want.

Display examples:

Display	Disc player
"CD CH"	CD changer
"MD CH"	MD changer

Pause and play

Press the Control knob.

Each time you press the knob, the audio pauses or plays.



- Disc 10 is displayed as "0".
- The functions that can be used and the information that can be displayed will differ depending on the external disc players being connected.

Fast Forwarding and Reversing

Fast Forwarding

Hold down toward [▶▶] with the Control knob.
Release to resume the playback.

Reversing

Hold down toward [◀◀] with the Control knob.
Release to resume the playback.



- There is no sound while the Audio file is being searched.
- The accurate play time is not displayed during fast forwarding or reversing of the Audio file.
- You cannot fast Forwarding and Reversing while AAC file is being played.

Track/File Search

Searching for a music on the disc or in the Audio file folder.

Push the Control knob towards [◀◀] or [▶▶].

Function of disc changer/ Audio file

Disc Search/Folder Search

Selecting the disc set in the Disc changer or the folder recorded on the Audio file media.

Push the Control knob towards up or down.

Function of remote control

Direct Music Search

Doing Music Search by entering the music number.

1 Enter the music number

Press the number buttons on the remote control.



- You can select Direct music Search up to 999.

2 Do music Search

Press the [◀◀] or [▶▶] button.

Cancelling Direct Music Search

Press the [▶||] button.

Function of disc changers with remote control

Direct Disc Search

Doing Disc Search by entering the disc number.

1 Enter the disc number

Press the number buttons on the remote control.

2 Do Disc Search

Press the [+] or [-] button.

Cancelling Direct Disc Search

Press the [▶||] button.



- Input "0" to select disc 10.

Track/File/Disc/Folder Repeat

Replaying the music, disc in the Disc changer or Audio file folder you are listening to.

Press the [REP] button.

Each time you press the button, the Repeat Play alternates between the modes shown in the tables below.

In CD & External disc source

Repeat play	Display
Track Repeat	"TRAC REP"
Disc Repeat (In Disc Changer)	"Disc REP"
OFF	—

In Audio file source

Repeat play	Display
File Repeat	"File REP"
Folder Repeat	"FOLD REP"
OFF	—

CD/Audio file/External disc control features

Scan Play

Playing the first part of each music on the disc or Audio file folder you are listening to and searching for the music you want to hear.

1 Start Scan Play

Press the [SCAN] button.

"TRAC SCN" (CD)/ "File SCN" (Audio file) is displayed.

2 Release it when the music you want to listen to is played

Press the [SCAN] button.

Random Play

Play all the music on the disc or Audio file folder in random order.

Press the [RDM] button.

Each time you press the button, Random Play turns ON or OFF.

When the Random mode is ON, "Disc RDM" (CD)/ "FOLD RDM" (Audio file) is displayed.



- When you push the Control knob toward [▶▶], the next selected music starts.

Function of disc changer

Magazine Random Play

Play the music on all the discs in the disc changer in random order.

Press the [M.RDM] button.

Each time you press the button, the Magazine Random Play turns ON or OFF.

When the Magazine Random mode is ON, "MGZN RDM" is displayed.



- When you push the Control knob toward [▶▶], the next selected music starts.

Function of Audio file

Folder Select

Quickly selecting the folder you want to hear.

1 Enter Folder Select mode

Press the [F.SEL] button.

"FOLD SEL" is displayed.

During Select mode the folder information is displayed as shown below.



Folder name display

Displays the current folder name.

2 Select the folder level

Push the Control knob towards up or down.

With the up of the Control knob, you move 1 level down and with the down of the Control knob, 1 level up.

Selecting a folder in the same level

Push the Control knob towards right or left.

With the left of the Control knob, you move to the previous folder, and with the right of the Control knob, to the next folder.

Returning to the top level

Press the [3] button.

3 Decide the folder to play

Press the Control knob.

The Folder Select mode releases, and the Audio file in the folder being displayed plays.

Cancelling the Folder Select mode

Press the [F.SEL] button.

Text/Title Scroll

Scrolling the displayed CD text, Audio file text, or MD title.

Push the Control knob toward up for at least 2 seconds.

Menu system

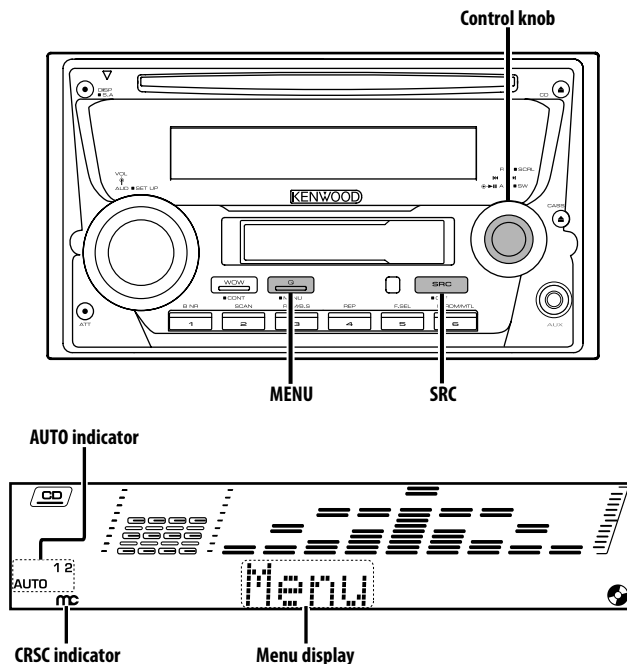

Menu System

Setting beep sound during operation, etc. functions.

The Menu system basic operation method is explained here. The reference for the Menu items and their setting content is after this operation explanation.

1 Enter Menu mode

Press the [MENU] button for at least 1 second.

"Menu" is displayed.

2 Select the menu item

Push the Control knob towards up or down.

Example: When you want to set the beep sound select the "BEEP" display.

3 Set the menu item

Push the Control knob towards right or left.

Example: When you select "BEEP", each time you push the knob it alternates between "BEEP ON" or "BEEP OFF". Select 1 of them as the setting.

You can continue by returning to step 2 and setting other items.

4 Exit Menu mode

Press the [MENU] button.



- When other items those applicable to the basic operation method above are displayed, their setting content chart is entered. (Normally the setting listed at the top of the chart is the original setting.) Also, the explanation for items that are not applicable (<Manual Clock Adjustment> etc.) are entered step by step.

In Standby mode

Activating Security Code

Activating the Security Code disables the usage of audio unit by someone else. Once the Security Code is activated, the entry of authorized Security Code is required to turn on the audio unit when it is removed from the vehicle. Indication of this Security Code activation prevents your precious audio unit from stealing.



- You can set the Security Code with a 4 digit number of your choice.
- The Security Code cannot be displayed or referenced. Make a note of the Security Code and treasure it up.

1 Enter Standby

Press the [SRC] button.

Select the "STANDBY" display.

2 Enter Menu mode

Press the [MENU] button for at least 1 second.

When "Menu" is displayed, "CODE SET" is also displayed.

3 Enter Security Code mode

Press the Control knob for at least 1 second.

When "ENTER" is displayed, "CODE" is also displayed.

4 Select the digits to enter

Push the Control knob towards right or left.

5 Select the Security Code numbers

Push the Control knob towards up or down.

6 Repeat steps 4 and 5, and complete the Security Code.

7 Confirm the Security Code

Press the Control knob for at least 3 seconds.

When "RE-ENTER" is displayed, "CODE" is also displayed.

8 Do the step 4 through 7 operation, and reenter the Security Code.

"APPROVED" is displayed.

The Security Code function activates.



- If you enter the wrong Code in steps 4 through 6, repeat from step 4.

Resetting the Security Code function when the audio unit is first used after removed from the battery power source or the Reset button is pressed

1 Turn the power ON.

2 Do the step 4 through 7 operation, and enter the Security Code.

"APPROVED" is displayed.

Now, you can use the unit.



- When the Security Code function is activated, "CODE SET" changes to "CODE CLR".
- To deactivate the Security Code function, see the next section <Deactivating Security Code>.

In Standby mode

Deactivating Security Code

To deactivate the Security Code function.

1 Select Security Code mode

Push the Control knob towards up or down.

Select the "CODE CLR" display.

2 Enter Security Code mode

Press the Control knob for at least 1 second.

When "ENTER" is displayed, "CODE" is also displayed.

3 Select the digits to enter

Push the Control knob towards right or left.

4 Select the Security Code numbers

Push the Control knob towards up or down.

5 Repeat steps 3 and 4, and complete the Security Code.

6 Press the Control knob for at least 3 seconds.

"CLEAR" is displayed.

The Security Code function deactivates.



- If a wrong security code is entered, "ERROR" is displayed. Enter a correct security code.

In Standby mode

Touch Sensor Tone

Setting the operation check sound (beep sound) ON/OFF.

Display	Setting
"BEEP ON"	Beep is heard.
"BEEP OFF"	Beep canceled.

Menu system

In Standby mode

Contrast Adjustment

Adjusting the display contrast.

Display and Setting
"CONT 1"
⋮
"CONT 6" (Original setting)
⋮
"CONT 11"

In Standby mode

Manual Clock Adjustment

1 Select Clock Adjustment mode

Push the Control knob towards up or down.

Select the "CLK ADJ" display.

2 Enter Clock Adjust mode

Press the Control knob for at least 1 second.

3 Adjust the hours

Push the Control knob towards up or down.

Adjust the minutes

Push the Control knob towards right or left.

4 Exit Clock adjustment mode

Press the [MENU] button.

In Standby mode

Switching preout

Alternating the preout between the rear and subwoofer. (With the subwoofer the sound outputs without being effected by fader control.)

Display	Setting
"SWPRE R"	Rear preout.
"SWPRE SW"	Subwoofer preout.

In Standby mode

Opening Demonstration

Setting the Demonstration when Power is turned ON.

Display	Setting
"Open ON"	Demonstration is carried out when Power is turned ON.
"Open OFF"	Demonstration is not carried out when Power is turned ON.

In Standby mode

Built-in Amp Setting

Controlling the built-in amplifier.

Turning OFF this control enhances the preout quality.

Display	Setting
"AMP ON"	The built-in amplifier activates.
"AMP OFF"	The built-in amplifier deactivates.

In Standby mode

Built-in Auxiliary input Setting

Set the Built-in Auxiliary Input function.

Display	Setting
"AUX OFF"	When selecting the source there's no Auxiliary Input.
"AUX ON"	When selecting the source there's Auxiliary Input.

In Standby mode

CD Read Setting

When there is a problem with playing a CD with special format, this setting plays the CD by force.

Display	Setting
"CD READ 1"	Play CD and Audio file.
"CD READ 2"	Play CD by force.



- Some music CDs may not play even in the "CD READ 2" mode.

In Standby mode

DSI (Disabled System Indicator)

A red indicator will blink on the unit after the ACC is set to OFF, warning potential thieves.

Display	Setting
"S.I ON"	LED flashes.
"S.I OFF"	LED OFF.

*Other than Standby mode/
When the Dual Zone System is ON*

Dual Zone System Setting

Setting the Front channel and Rear channel sound in the Dual Zone System.

Display	Setting
"ZONE2 R"	Sub source (Auxiliary input source) is to be rear channel.
"ZONE2 F"	Sub source (Auxiliary input source) is to be front channel.

Other than Standby mode

B.M.S. (Bass Management System)

Adjust the bass boost level of the external amplifier using the main unit.

Display	Setting
"BMS FLT"	Bass boost level is flat.
"BMS +6"	Bass boost level is low (+6dB).
"BMS +12"	Bass boost level is mid (+12dB).
"BMS +18"	Bass boost level is high (+18dB).



- Refer to the catalog or instruction manual for power amplifiers that can be controlled from this unit.
- For amplifiers, there are the models you can set from Flat to +18 dB, and the models you can set from Flat to +12 dB.
When an amplifier that can only be set to +12 is connected to the unit, "BMS +18" will not work correctly even if it is selected.

Other than Standby mode

B.M.S. Frequency Offset

Setting the central frequency, boosted by B.M.S.

Display	Setting
"BMSF NML"	Boost with the normal central frequency.
"BMSF Low"	Drop the normal central frequency 20%.

In FM reception

CRSC (Clean Reception System Circuit)

Temporarily have reception alternate from stereo to mono to reduce multi-path noise when listening to the FM station.

Display	Setting
"CRSC On"	The CRSC is ON.
"CRSC Off"	The CRSC is OFF.



- Strong electrical fields (such as from power lines) may cause unstable sound quality when CRSC is turned ON. In such a situation, turn it OFF.

Menu system

Auxiliary Input Display Setting & Station/Disc Naming

Selecting the display when changing to Auxiliary input source. For the Station/Disc Naming refer to the <Station/Disc Naming (SNPS/DNPS)> (page 11).

1 Select Auxiliary input source

Press the [SRC] button.

Select the "AUX"/"AUX EXT" display.

2 Enter Menu mode

Press the [MENU] button for at least 1 second.

"Menu" is displayed.

3 Select Auxiliary input display setting mode

Push the Control knob towards up or down.

Select the "Name Set" display.

4 Enter Auxiliary input display setting mode

Press the Control knob for at least 2 second.

The presently selected Auxiliary input display is displayed.

5 Select the Auxiliary input display

Push the Control knob towards right or left.

Each time you push the knob, the display alternates as listed below.

- "AUX"/"AUX EXT"
- "DVD"
- "PORTABLE"
- "GAME"
- "VIDEO"
- "TV"

6 Exit Auxiliary input display setting mode

Press the [MENU] button.



- When operation stops for 10 seconds, the name at that time is registered, and the Auxiliary input display setting mode closes.
- The Auxiliary Input Display can be set only when the built-in auxiliary input or the auxiliary input of optional KCA-S220A is used.

Text Scroll

Setting the displayed text scroll.

Display	Setting
"SCL Auto"	Repeats scroll.
"SCL Manu"	Scrolls when the display changes.



- The text scrolled is listed below.
 - CD text
 - Folder name/ File name/ Music title/ Artist name/ Album name
 - MD title

In Tuner mode

Tuning Mode

Sets the tuning mode.

Tuning mode	Display	Operation
Auto seek	"Auto 1"	Automatic search for a station.
Preset station seek	"Auto 2"	Search in order of the stations in the Preset memory.
Manual	"Manual"	Normal manual tuning control.

In Tuner mode

Auto Memory Entry

For the operation method refer to <Auto Memory Entry> (page 13).

In CD mode

Supreme Setting

When AAC, MP3 or WMA files encoded at a low bit rate (less than 96kbps (fs=32k, 44.1k, 48kHz)) are played, this function restores their high frequency region to approach the sound quality of equivalents of these files encoded at a high bit rate. Processing is optimized for the compression format used (AAC, MP3, or WMA), and adjustment is made for the bit rate used.

Display	Setting
"SPRM ON"	Plays sound using the Supreme function.
"SPRM OFF"	Plays the original sound stored in the audio file.



- The sound effect may be imperceptible depending on the relationship between the audio file format and setting.

Basic Operations of remote control

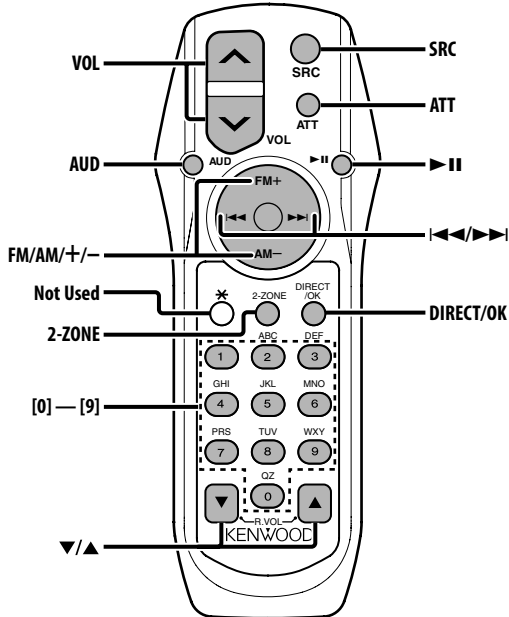

Loading and Replacing the battery

Use two "AA" / "R6"-size batteries.
Slide the cover while pressing downwards to remove it as illustrated.
Insert the batteries with the + and - poles aligned properly, following the illustration inside the case.

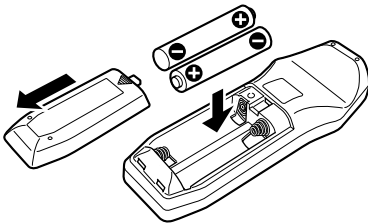

▲WARNING

- Store unused batteries out of the reach of children.
Contact a doctor immediately if the battery is accidentally swallowed.



- Do not set the remote control in hot places such as on the dashboard.

Basic operations

[VOL] buttons

Adjusts the volume.

[SRC] button

Each time you press the button, the source alternates.

For the source alternating order refer to <Selecting the Source> (page 6).

[ATT] button

Turns the volume down quickly.

When the button is pressed again, the volume returns to the previous level.

Basic Operations of remote control

Audio Control

[AUD] button

Selects the Audio item to be adjusted.

[VOL] buttons

Adjusts the Audio item.



- Refer to <Audio Control> (page 7) for the operation method, such as the procedures for Audio control and others operations.

Dual Zone System

[2-ZONE] button

Each time you press the button, "2ZON" of <Audio Setup> (page 8) is turned ON or OFF.

[▲]/ [▼] buttons

Adjusts the volume of the rear channel.

The rear channel activates while the Dual Zone System is ON.

In Tuner source

[FM]/ [AM] buttons

Selects the band.

Each time you press the [FM] button, the band alternates between the FM1, FM2, and FM3 bands.

[◀◀]/ [▶▶] buttons

Tune up or down band.

[0] — [9] buttons

Press buttons [1] — [6] to recall preset stations.

[DIRECT]/ [OK] button

Enters and cancels the <Direct Access Tuning> (page 12) mode.

In Cassette tape source

[◀◀]/ [▶▶] buttons

Do <DPSS (Direct Program Search System)> (page 15).

[▶II] button

Plays the reverse side of the tape.

[FM] button

Fast forwards the tape.

When you press the [▶II] button again, the fast forwarding releases.

[AM] button

Rewinds the tape.

When you press the [▶II] button again, the rewarding releases.

[0] — [9] buttons

When in <DPSS with the Remote control> (page 15), enter the number of music.

In Disc source

[◀◀]/ [▶▶] buttons

Going forwards and backwards between music.

[+]/ [-] buttons

Going forwards and backwards between disc/ folders.

[▶II] button





Each time you press the button, the music is played or paused.

[0] — [9] buttons

When in <Direct Music Search> (page 17) and <Direct Disc Search> (page 17), enters the music/ disc number.

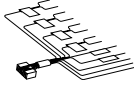
Accessories/ Installation Procedure

Accessories

①	1
②	1
③	6
④	6

Installation Procedure

1. To prevent a short circuit, remove the key from the ignition and disconnect the \ominus battery.
2. Make the proper input and output wire connections for each unit.
3. Connect the speaker wires of the wiring harness.
4. Connect the wiring harness wires in the following order: ground, battery, ignition.
5. Connect the wiring harness connector to the unit.
6. Install the unit in your car.
7. Reconnect the \ominus battery.
8. Press the reset button.

▲WARNING

If you connect the ignition wire (red) and the battery wire (yellow) to the car chassis (ground), you may cause a short circuit, that in turn may start a fire. Always connect those wires to the power source running through the fuse box.



- If the power is not turned ON (or it is ON, but will be OFF immediately), the speaker wire may have a short-circuit or touched the chassis of the vehicle and the protection function may have been activated. Therefore, the speaker wire should be checked.
- If your car's ignition does not have an ACC position, connect the ignition wires to a power source that can be turned on and off with the ignition key. If you connect the ignition wire to a power source with a constant voltage supply, as with battery wires, the battery may die.
- If the console has a lid, make sure to install the unit so that the faceplate will not hit the lid when closing and opening.
- If the fuse blows, first make sure the wires aren't touching to cause a short circuit, then replace the old fuse with one with the same rating.
- Insulate unconnected wires with vinyl tape or other similar material. To prevent a short circuit, do not remove the caps on the ends of the unconnected wires or the terminals.
- Connect the speaker wires correctly to the terminals to which they correspond. The unit may be damaged or fail to work if you share the \ominus wires or ground them to any metal part in the car.
- When only two speakers are being connected to the system, connect the connectors either to both the front output terminals or to both the rear output terminals (do not mix front and rear). For example, if you connect the \oplus connector of the left speaker to a front output terminal, do not connect the \ominus connector to a rear output terminal.
- After the unit is installed, check whether the brake lamps, blinkers, wipers, etc. on the car are working properly.
- Mount the unit so that the mounting angle is 30° or less.

Connecting Wires to Terminals

To connect the Disc changer, consult your Disc changer manual.

Kenwood disc changer control input

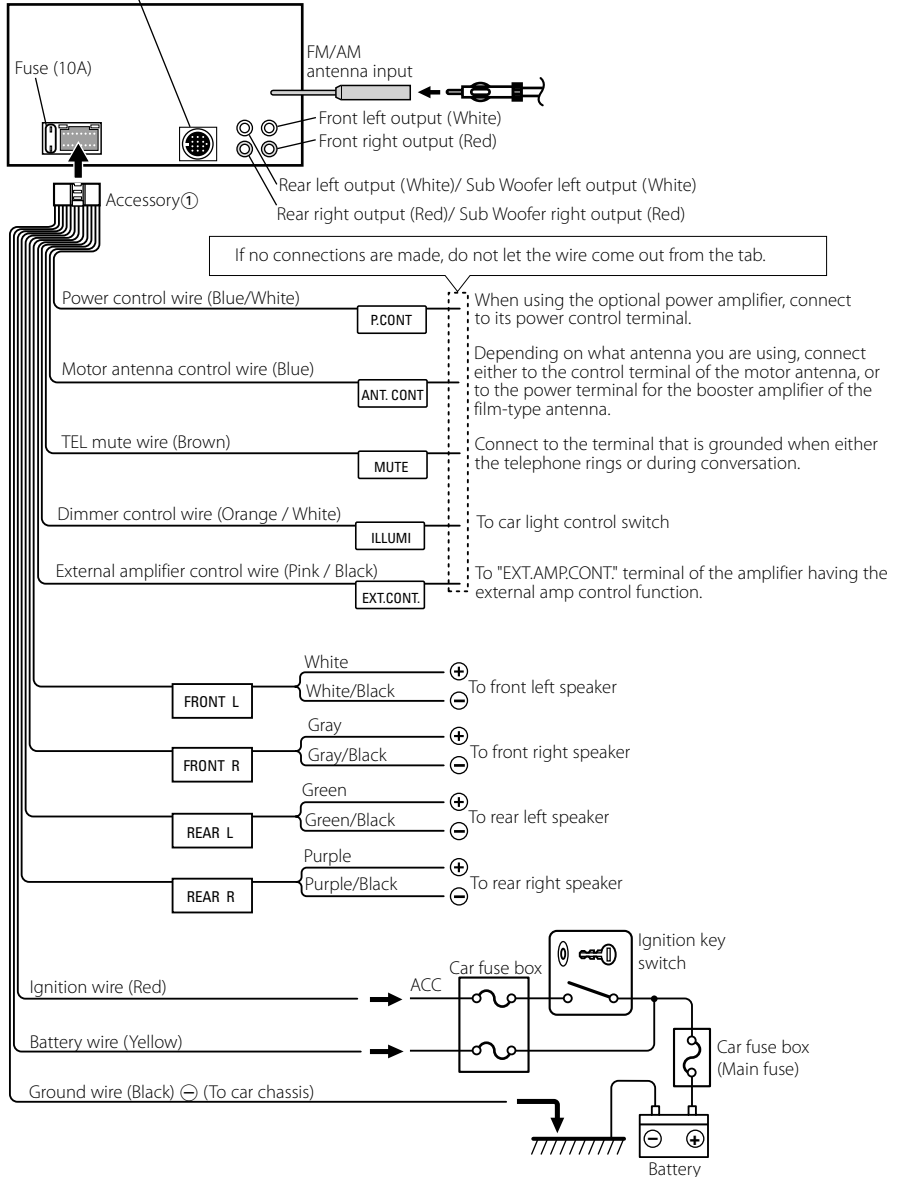

Installation

Install onto the car bracket using the supplied screws (M5 × 7 mm, M5 × 6 mm). The holes of the car bracket to use will differ depending on the car model.

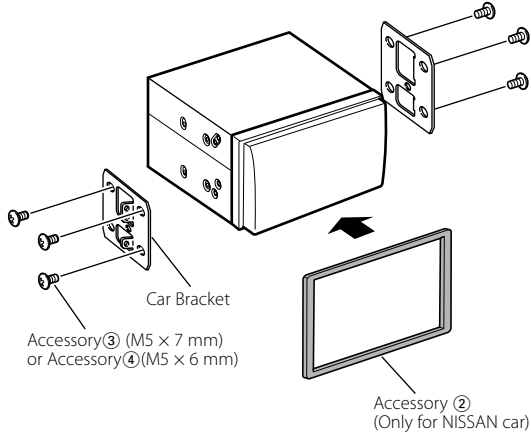

Troubleshooting Guide

Some functions of this unit may be disabled by some settings made on this unit.

! Cannot switch to Aux source.

- ▶ AUX is not turned on.
☞ <Built-in Auxiliary input Setting> (page 22)

! Cannot set up the subwoofer.

- **No output from the subwoofer.**
 - ▶ Preout is not set to subwoofer.
☞ <Switching preout> (page 22)
 - <Subwoofer Output> (page 10) is not set to ON.
 - The Dual zone function is enabled.
☞ <Audio Setup> (page 8)

! Cannot set up the subwoofer phase.

- ▶ Preout is not set to subwoofer.
☞ <Switching preout> (page 22)
- <Subwoofer Output> (page 10) is not set to ON.
- The Dual zone function is enabled.
☞ <Audio Setup> (page 8)
- Low pass filter is set to Through.
☞ <Audio Setup> (page 8)

! Cannot set up the low pass filter.

- ▶ Preout is not set to subwoofer.
☞ <Switching preout> (page 22)
- The Dual zone function is enabled.
☞ <Audio Setup> (page 8)

! Cannot set up the high pass filter.

- ▶ The Dual zone function is enabled.
☞ <Audio Setup> (page 8)

! Cannot select the output destination of the subsource in the Dual zone.

- **Cannot adjust the volume of the rear speakers.**
 - ▶ The Dual zone function is disabled.
☞ <Audio Setup> (page 8)

! No Audio control effect on AUX.

- **Cannot set up the Preout.**
 - ▶ The Dual zone function is enabled.
☞ <Audio Setup> (page 8)

! Cannot play audio files.

- ▶ <CD Read Setting> (page 22) is set to "2".

! Cannot Folder select.

- ▶ The Scan play or Random play function is enabled.

! Cannot set up WOW.

- ▶ The Dual zone function is disabled.
☞ <Audio Setup> (page 8)

! Cannot set up SRS 3D.

- ▶ The tuner source is in use.

! No Audio control effect on the rear speakers.

- ▶ WOW item on <SRS WOW Select> (page 9) and SRS WOW item on <SRS WOW Control> (page 9) have no effect on the rear speakers.

What might seem to be a malfunction in your unit may just be the result of slight misoperation or miswiring. Before calling service, first check the following table for possible problems.

General

? The Touch Sensor Tone doesn't sound.

- ✓ The preout jack is being used.
☞ The Touch Sensor Tone can't be output from the preout jack.

Tuner source

? Radio reception is poor.

- ✓ The car antenna is not extended.
☞ Pull the antenna out all the way.
- ✓ The antenna control wire is not connected.
☞ Connect the wire correctly, referring to the section on <Connecting Wires to Terminals>.

Disc source

? The specified disc does not play, but another one plays instead.

- ✓ The specified CD is quite dirty.
☞ Clean the CD.
- ✓ The disc is loaded in a different slot from that specified.
☞ Eject the disc magazine and check the number for the specified disc.
- ✓ The disc is severely scratched.
☞ Try another disc instead.

Audio file source

? The sound skips when an Audio file is being played.

- ✓ The media is scratched or dirty.
☞ Clean the media, referring to the CD cleaning of the section on <Handling CDs> (page 5).
- ✓ The recording condition is bad.
☞ Record the media again or use another media.

Cassette tape source

? The sound quality is poor or distorted.

- ✓ The tape head is dirty.
🔧 Clean the tape head.

? The DPSS, Tape Advance and Music Repeat don't operate correctly.

- ✓ The space between the songs on the tape can't be recognized because it's too short.
🔧 Have at least 4 seconds between songs.
- ✓ The space between songs can't be recognized because there's too much noise between songs.
🔧 Reduce the noise between songs.

? The blank skip doesn't work.

- ✓ Because noise is too loud, the non-recorded part can't be recognized.
🔧 Reduce the noise between songs.

? Blank Skip functions at places that are recorded.

- ✓ Because the recording level is low, it's recognized as not recorded.
🔧 Turn Blank Skip OFF.

The messages shown below display your systems condition.

Eject:	No disc magazine has been loaded in the changer. The disc magazine is not completely loaded. ⇨ Load the disc magazine properly. No CD in the unit. ⇨ Insert the CD.
No Disc:	No disc has been loaded in the disc magazine. ⇨ Load a disc into the disc magazine.
TOC Error:	No disc has been loaded in the disc magazine. ⇨ Load a disc into the disc magazine. The CD is quite dirty. The CD is upside-down. The CD is scratched a lot. ⇨ Clean the CD and load it correctly.
Error 05:	The CD is upside-down. ⇨ Load the CD correctly.
Blank:	Nothing has been recorded on the MD.
No Track:	No tracks are recorded on the MD, although it has a title.
Error 15:	Media was played that doesn't have data recorded that the unit can play. ⇨ Use media that has data recorded that the unit can play.

Error 77:	The unit is malfunctioning for some reason. ⇨ Press the reset button on the unit. If the "E-77" code does not disappear, consult your nearest service center.
Error 99:	The unit is malfunctioning for some reason. ⇨ Press the reset button on the unit. If the "E-99" code does not disappear, consult your nearest service center.
Hold:	The protective circuit in the unit activates when the temperature inside the automatic disc changer exceeds 60°C (140°F), stopping all operation. ⇨ Cool down the unit by opening the windows or turning on the air conditioner. As the temperature falls below 60°C (140°F), the disc will start playing again.
No Name:	Attempted to display DNPS during the CD play having no disc names preset.
Load:	Discs are being exchanged in the Disc changer.
Reading:	The unit is reading the data on the disc.
🌀 (Blink):	The CD player section is not operating properly. ⇨ Reinsert the CD. If the CD cannot be ejected or the display continues to flash even when the CD has been properly reinserted, please switch off the power and consult your nearest service center.
📼 (Blink):	The tape player section is not operating properly. ⇨ Reinsert the Tape. If the tape cannot be ejected or the display continues to flash even when the tape has been properly reinserted, please switch off the power and consult your nearest service center.
PROTECT:	The speaker wire has a short-circuit or touches the chassis of the vehicle, and then the protection function is activated. ⇨ Wire or insulate the speaker cable properly and press the reset button.
N/A File:	An Audio file is played with a format that this unit can't support. ⇨ ----
Copy PRO:	A copy-protected file is played. ⇨ ----

Specifications

Specifications subject to change without notice.

FM tuner section

- Frequency range
 - 50 kHz space: 87.5 MHz – 108.0 MHz
 - 200 kHz space: 87.9 MHz – 107.9 MHz
- Channel Space Selection
 - : 50 k/200 kHz
- Usable sensitivity (S/N = 30dB)
 - : 9.3dBf (0.8 μ V/75 Ω)
- Quieting Sensitivity (S/N = 50dB)
 - : 15.2dBf (1.6 μ V/75 Ω)
- Frequency response (\pm 3 dB)
 - : 30 Hz – 15 kHz
- Signal to Noise ratio (MONO)
 - : 70 dB
- Selectivity (\pm 400 kHz)
 - : \geq 80 dB
- Stereo separation (1 kHz)
 - : 40 dB

AM tuner section

- Frequency range
 - 9 kHz space: 531 kHz – 1611 kHz
 - 10 kHz space: 530 kHz – 1700 kHz
- Channel Space Selection
 - : 9 k/10 kHz
- Usable sensitivity (S/N = 20dB)
 - : 28 dB μ (25 μ V)

CD player section

- Laser diode
 - : GaAlAs
- Digital filter (D/A)
 - : 8 Times Over Sampling
- D/A Converter
 - : 1 Bit
- Spindle speed
 - : 1000 – 400 rpm (CLV 2times)
- Wow & Flutter
 - : Below Measurable Limit
- Frequency response (\pm 1 dB)
 - : 10 Hz – 20 kHz
- Total harmonic distortion (1 kHz)
 - : 0.008 %
- Signal to Noise ratio (1 kHz)
 - : 105 dB
- Dynamic range
 - : 93 dB
- MP3 decode
 - : Compliant with MPEG-1/2 Audio Layer-3
- WMA decode
 - : Compliant with Windows Media Audio
- AAC decode
 - : AAC-LC ".m4a" files

Cassette player section

- Tape speed
 - : 4.76 cm/sec.
- Wow & Flutter (WRMS)
 - : 0.1 %
- Frequency response (70 μ s)
 - : 40 Hz – 20 kHz (\pm 3 dB)
- Separation (1 kHz)
 - : 35 dB
- Signal to Noise ratio
 - Dolby NR Off : 50 dB
 - Dolby B NR On : 60 dB

Audio section

- Maximum output power
 - : 50 W x 4
- Full Bandwidth Power (at less than 1% THD)
 - : 22 W x 4
- Speaker Impedance
 - : 4 – 8 Ω
- Tone action
 - Bass : 100 Hz \pm 8 dB
 - Middle : 1 kHz \pm 8 dB
 - Treble : 10 kHz \pm 8 dB
- Preout level / Load (during disc play)
 - : 2500 mV/10 k Ω
- Preout impedance
 - : \leq 600 Ω

Auxiliary input

- Frequency response (\pm 1 dB)
 - : 20 Hz – 20 kHz
- Input Maximum Voltage
 - : 1200 mV
- Input Impedance
 - : 100 k Ω

General

- Operating voltage (11 – 16V allowable)
 - : 14.4 V
- Current consumption
 - : 10 A
- Installation Size (W x H x D)
 - : 178 x 100 x 155 mm
- Weight
 - : 2.1 kg