

*The Strength of*  
**Digital**

**DQS<sup>™</sup>**

Six Channel  
Digital Equalizer

***Owner's Enjoyment Manual***

**AudioControl<sup>®</sup>**

22410 70th Avenue West • Mountlake Terrace, WA 98043 USA

Phone 425-775-8461 • Fax 425-778-3166

[www.audiocontrol.com](http://www.audiocontrol.com)

# **AudioControl®**

---

This page was intentionally

***Owner's Enjoyment Manual***

# ***The Strength of Digital™***

---

## Table of Contents

Introduction .....	1
Key Features and Highlights .....	2
Quick Installation Information .....	4
A Guided Tour of the DQS .....	6
Installation .....	8
Placement and Mounting .....	8
Power Wiring .....	9
Audio Wiring and System Diagrams .....	9-11
Level Matching .....	12
Navigating the DQS Menu Screens .....	13
Equalization Adjustment .....	18
Troubleshooting .....	20
Warranty .....	22
Specifications .....	23

**AudioControl®**

---

***Owner's Enjoyment Manual***

# ***The Strength of Digital™***

---

## **Introduction**

Welcome to the world of AudioControl digital signal processing . A magical combination of AudioControl's lengthy experience in performance signal processing design combined with state-of-the-art Digital Signal Processing (DSP) technology. You now have in your possession the DQS, an extremely powerful six channel, thirty-band, one-third-octave stereo graphic and parametric digital equalizer. Whew, try saying that fast a few times. Even better the DQS has a total of 192 equalization controls making it an incredible addition to any multi-channel system...even car theater! Whether you are a die-hard sound-off competitor or simply enjoy great music, you will definitely appreciate how the DQS makes your performance autosound system sound even better.

Now before you start salivating too much just thinking about the benefits of the DQS, take a few minutes to sit back, have a latte', decaffeinated if necessary, and read through this manual. It contains lots of useful facts and information... and besides, we spent a lot of time writing it!

## **KEY FEATURES OF THE DQS**

Here are some of the cool features that are enclosed in this magical box:

- Six input and output channels
- 30 bands of constant-Q equalization ... on each channel
- Two, fully-adjustable parametric equalizers per pair of channels
- Eight non-volatile memories
- 24 bit digital signal processing

## FEATURES AND HIGHLIGHTS

**Six Channels Of Input and Output:** The DQS is AudioControl's first digital car audio equalizer with six input and output channels making it ideal for a multitude of applications. Whether you are designing around a source unit with multiple outputs or you have a full blown surround sound car theater system, the DQS is the processor for you.

**Input and Output Level Controls:** To help accurately level match your source units and amplifiers, the DQS has individual input and output level controls. This will help you maximize the sound quality of your system and minimize any system noise. These controls will also help your DQS work with factory installed source units.

**Constant-Q Equalization Controls:** Car interiors vary widely in size and acoustic make-up. Doors, kick-panels, and rear decks don't make the best location for speaker placement causing your high performance speaker system to sound somewhat lackluster. The DQS offers thirty precise one-third octave equalization controls per channel for a total of 180 filters!

**Parametric Equalization Controls:** In addition to offering thirty, one-third octave controls, the DQS also packs two, fully-adjustable parametric equalization controls for each pair of channels. With the DQS's parametric controls you can select a center frequency, dial in the ideal bandwidth and apply the appropriate amount of boost or cut. The precise filtering of the DQS allows you to select bandwidths as narrow as 1/12 octave!

**Non-volatile Memories:** The DQS has the ability to allow the user to set and store up to eight different system equalization settings in individual memory locations.

**24-bit Digital Signal Processing:** AudioControl's digital signal processors use a special 24-bit DSP (digital signal processor) that was specifically designed for equalization and other dynamics processing. Matching 24-bit A/D - D/A converters are also incorporated for maximum sound quality.

# ***The Strength of Digital™***

---

**Bulletproof Warranty:** The most important feature of all. Every AudioControl product is selflessly designed and manufactured by the occupants of our rainforest factory. We take every effort to ensure that you will have many years of enjoyment out of your DQS. To ensure the performance of this new Digital product, we highly recommend that you allow your authorized AudioControl dealer to perform the installation. Not only do they have all the right knowledge and tools, but also in the unlikely chance your DQS should stop working, we will back it with a limited five years parts and labor warranty. Should you choose to install it yourself we will still give you a one-year parts and labor warranty. To activate your warranty, you need to FILL OUT AND SEND IN YOUR WARRANTY CARD!

We also recommend that you save your invoice or sales slip as proof of installation and ownership. Not only is it necessary for warranty purposes, but should your DQS “disappear” one day while your car is parked at your local latte’ stand, you will find insurance companies very unforgiving without proof of purchase.



## QUICK INSTALLATION INFORMATION

For those of you short on time, but high on ambition, we offer the following section to speed up your installation of the DQS:

- 1.** The DQS needs to be installed in the signal path between your source unit and your external amplifier(s). If this is not obvious to you, quickly pack up your DQS and run to your nearest authorized AudioControl dealer to have them perform the installation. You will thank us later.
- 2.** Physically mount the DQS in a location that keeps it away from soda spills, food crumbs, and curious fingers. However, you will want to select a location that allows you to see the display and access the equalization controls during setup.
- 3.** Hook up +12 volt power, ground, and remote turn-on. If you need to know more, then read on. Heck, if you don't think you need to know more, you should still read on, because you can never know too much.

- 4.** Adjust the "Input Level" control on your DQS to match the source unit's output and then adjust the "Output Level" controls to match your amplifier inputs.

**Note:** *You will want to turn the gains on your amplifiers DOWN to maximize your systems performance.*

- 5.** Now comes the fun part. Set your equalization controls to where your system sounds the most balanced yet dynamic. More about this in the section titled "Adjusting Your Equalizer"... and you thought you would not have to read the rest of the manual. Hah!

- 6.** Last but not least, you will want to save your system settings in one of the eight memory locations.



# The Strength of Digital™

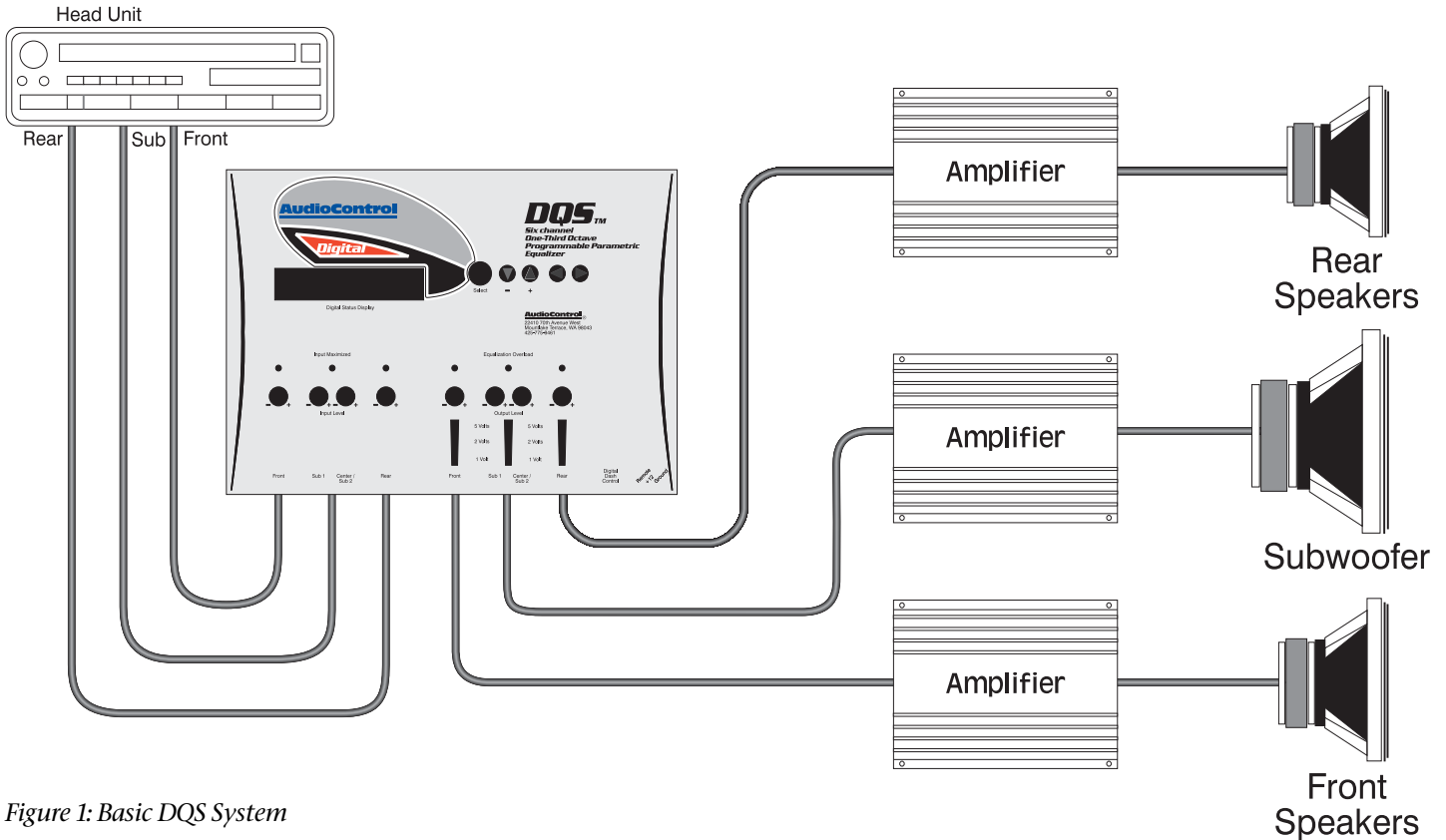

Figure 1: Basic DQS System

# AudioControl®

---

## A GUIDED TOUR OF DQS

**1) Inputs:** The DQS has six RCA inputs that need to get their audio signals from the main source unit. If your source unit only has two or four outputs, fear not, just use the front or rear inputs. See the system diagrams in this manual for some cool system ideas.

**2) Input Level:** These knobs allow you to maximize the signal level from your source unit that goes into your DQS to achieve maximum signal-to-noise ratio. Keep in mind that despite what the literature says, most aftermarket source units produce a relatively low voltage signal when it comes to playing music at normal levels.

**3) Input Maximized Indicators:** These nifty LEDs (Light Emitting Diode if you are curious) indicate that you are supplying the DQS its maximum amount of signal voltage. If the LED indicators never come on, don't assume that it is not working (since LEDs rarely break) but you might consider adding a line driver to your system.

**4) Output Level Controls:** Although your DQS has the ability to increase your signal voltage, your amplifiers may not necessarily accept that much signal. These controls allow you to regulate the proper amount of pre-amp signal from the DQS to the amplifiers.

**5) Equalization Overload Indicator:** This convenient LED indicates when the DSP (digital signal processor) of your DQS is clipping or distorting. The usual cause of this is having the "Input Level" turned up too high or you have too much overall boost on the various frequencies of your equalizer.

**6) Select:** This button allows you to select one of the various equalization, display, or memory modes of your DQS.

**7) Navigation Arrows:** These multi-function buttons perform a number of duties, depending upon which mode your DQS is in. You can do anything from applying boost or cut to your equalization filters to changing the display brightness. However, if you get the high score, you cannot enter your initials!

**8) Output Voltage Indicators:** These brightly colored LEDs indicate the level of signal voltage that is coming out of the various outputs of your DQS. Use these to assist in level matching your source unit with your amplifiers.

**9) Outputs:** These RCA connectors should be connected to the next component(s) after the DQS, usually an amplifier. Do not connect any speakers directly to your DQS or to any home appliances, like your toaster.

# The Strength of Digital™

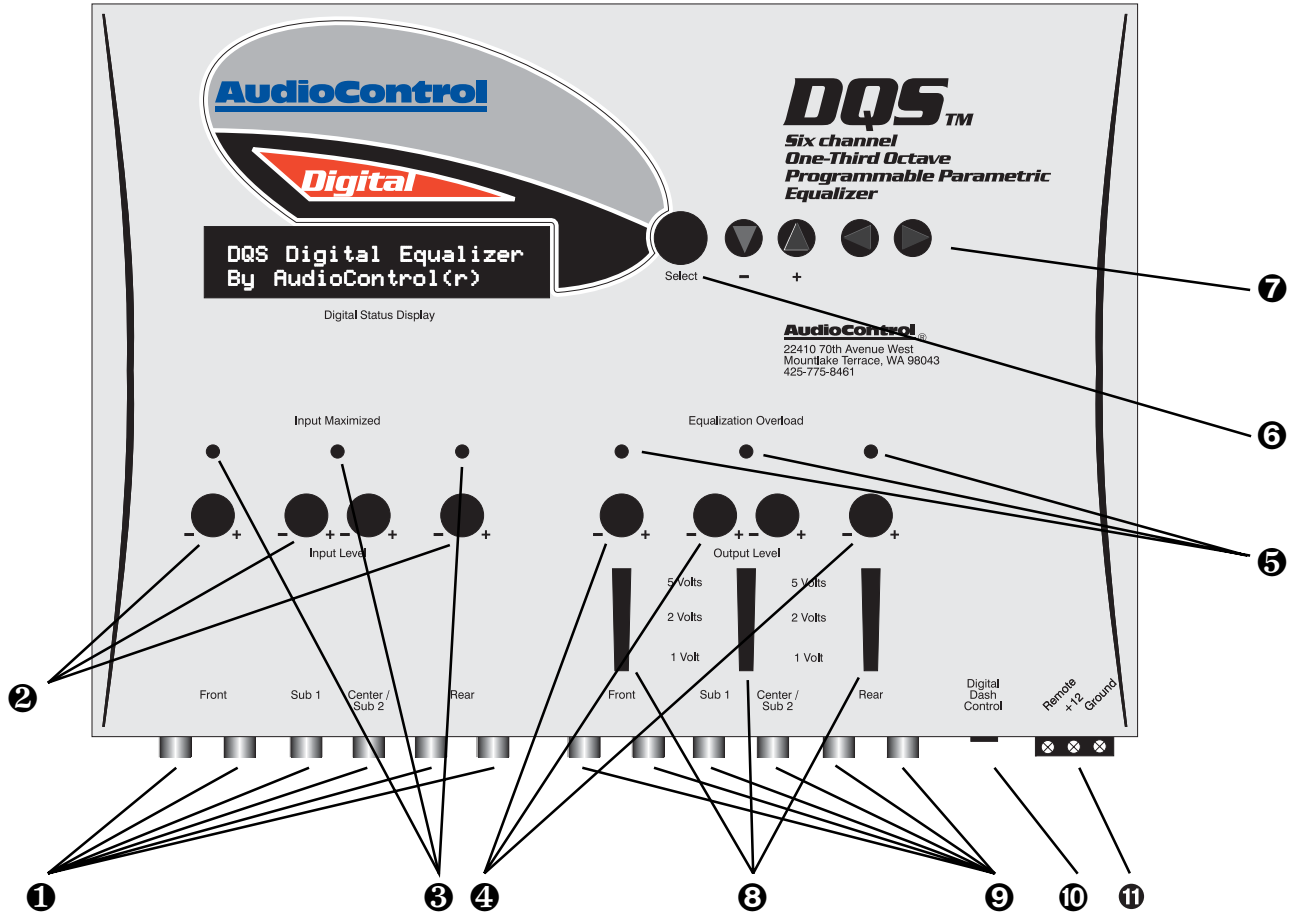

Figure 2: Top view of DQS

**10) Digital Dash Control Input:** This input allows you to connect the optional AudioControl Digital Dash Control (DDC) which will allow you to control your DQS from the convenience of the drivers seat, passengers seat, back seat or anywhere else the cable will stretch to. See your authorized AudioControl dealer for more information about this option.

**11) Power Connections:** This incredibly handy connector is a godsend to those who have tried to wire up their gear with their body crammed in the trunk. You can wire up the power, ground, and remote turn-on from the convenience of outside your car and then casually plug it into your DQS.

## INSTALLING THE DQS

Up to this point everything you have read has served to educate you on the operations of the DQS. We are sure that you are chomping at the bit to install your DQS so we recommend you read the following sections very carefully.

### **A. Placement & Mounting of your DQS**

**Placement:** The DQS needs to be installed in the signal path after your source unit but definitely before your amplifiers and/or any active crossovers. The chassis is usually mounted in the rear of the vehicle, as close to the amplifiers as possible.

**Mounting:** Once you have selected a permanent mounting location, position the unit and mark the appropriate mounting holes with a felt-tip pin or scratch awl. Before doing anything else, make sure you are not about to drill a hole in a gas tank or pierce any existing wiring. Nothing ruins your day more than an expensive repair bill. Drill a few small pilot holes and secure the chassis of the DQS with self-tapping screws.

## **B. DQS Power Wiring**

**WARNING:** *Failure to disconnect the negative terminal of your battery prior to the installation of your DQS can result in a warm tingly feeling.*

**Remote Turn-On:** Connect an 18 to 22 gauge wire from the head-unit's remote turn-on to the "Remote" connector on the DQS.

**Positive (+12V) Connection:** Insert a 12 to 18 gauge wire into the connector labeled "Power" on the nifty connector of your DQS. Connect it to a good constant source of 12 volts (we suggest the battery), fused at 2 amps.

**Ground Connection:** Use the same gauge wire or larger as you did for the positive connector and run it from the "Ground" connector on the DQS to the negative terminal of the battery, a ground bus, or a verified ground location. The factory head unit ground is **not, not, not** a good ground! When the electrical connections are complete, you may now reconnect the negative terminal to your battery.

## **C. DQS Audio Wiring**

**Planning:** As you may already have guessed, there are numerous ways to configure the DQS in your audio system. Spend a little quality time planning out your system and even sketching it out on paper. The following diagrams are just a few of the system options:

# AudioControl®

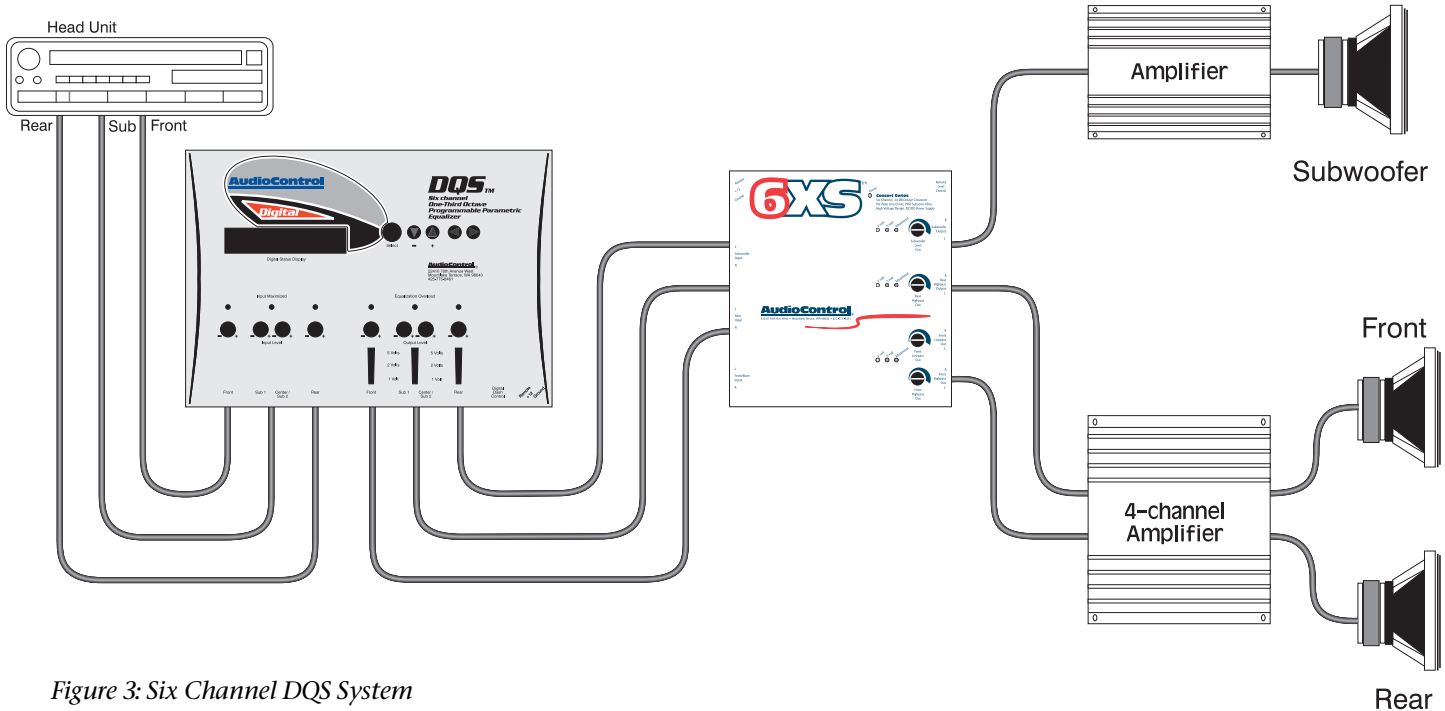

Figure 3: Six Channel DQS System

# The Strength of Digital™

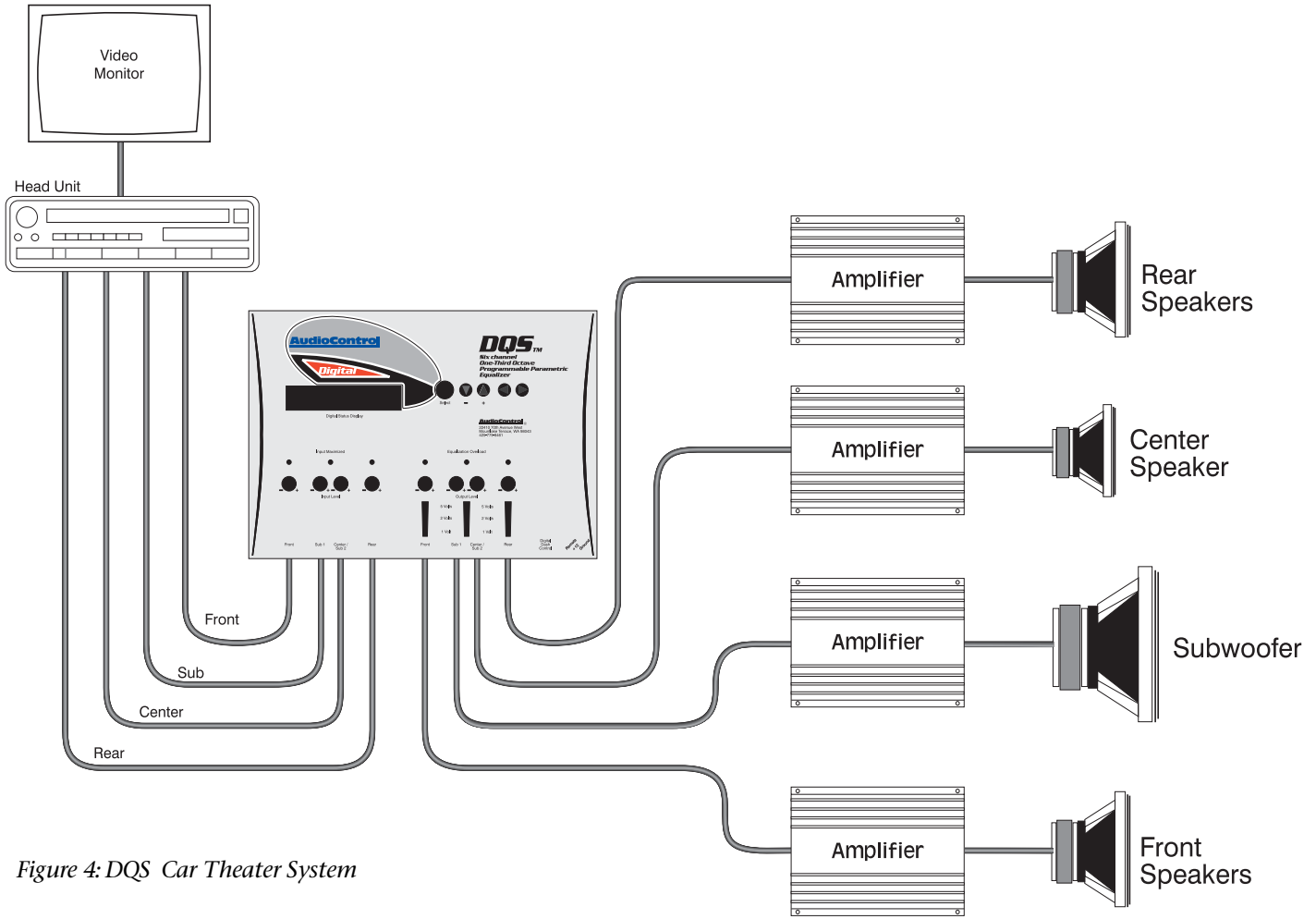

Figure 4: DQS Car Theater System

## D. Level Matching

If you have ever listened to a friend's "killer" car audio system and heard lots of hiss, clicks or pops, then you have experienced an improperly level matched system. When a performance autosound system is properly level matched, you should get the maximum output from your source unit and amplifiers without any clipping or that annoying hiss! The following steps will help guide you through the process, although at the end of the day, your ears will be your guide!

- 1) Set your source unit's fader and balance controls to their center positions.
- 2) Disconnect the output RCA connections between your DQS and the amplifier(s)...otherwise get some earplugs.
- 3) Start playing some relatively dynamic music and set the volume on your source unit to about 3/4 of maximum. You should not hear anything at this point. If you are hearing music, go back to step #2. If you are hearing voices, go see a doctor!
- 4) Starting with the DQS "Input Level" controls, adjust the control knobs until the "Input Maximized" LED begins to flicker steadily with the music.

5) Now adjust the output level control until the "2 volt" or "5 volt" light starts to flicker. You will want the output voltage to match up to your amplifiers input gain levels. If you don't know how much this is, ASK the amplifier manufacturer or read the owner's manual of the amplifier.

6) Very Important - Set the input gains on the amplifier(s) at minimum!

7) Double check that you performed Step #6

8) Decrease the volume control on your source unit and re-connect the RCAs between the DQS and the amplifier(s).

9) Now increase the volume on your source unit to your normal listening level. For some of you, this may be louder than others!

10) At this point you may find yourself going back and adjusting the "Output Level" controls on your DQS to accommodate for the speaker placement and efficiency.



## **DQS Menu Screens**

One of the major benefits of using Digital technology is the ability to use less knobs and buttons and get more control. The DQS has six, 30-band mono equalizers *plus* six 2-band parametric equalizers, that would normally require almost 200 individual controls and occupy an area as large as your trunk. AudioControl's digital technology allows the DQS to offer a plethora of features in one compact chassis. In addition there are only a few knobs so navigating through the DQS's functions is quite simple.

When you first apply power to your DQS, it will go through a few "wake-up" screens, including some subliminal advertising for AudioControl. It will then display a friendly blue screen (not the scary blue screen found on many computers). Fear not, because the blue screen on the DQS is actually a good thing.

**Menu Tree:** Once your DQS has settled on one of these menu screens, you will want to spend a few minutes familiarizing yourself with the various modes. Although the DQS has one main screen, there are eleven sub menu screens that allow you to access and program all of the various functions of your DQS. Figure 5 shows you how the Menu Tree of your DQS flows.

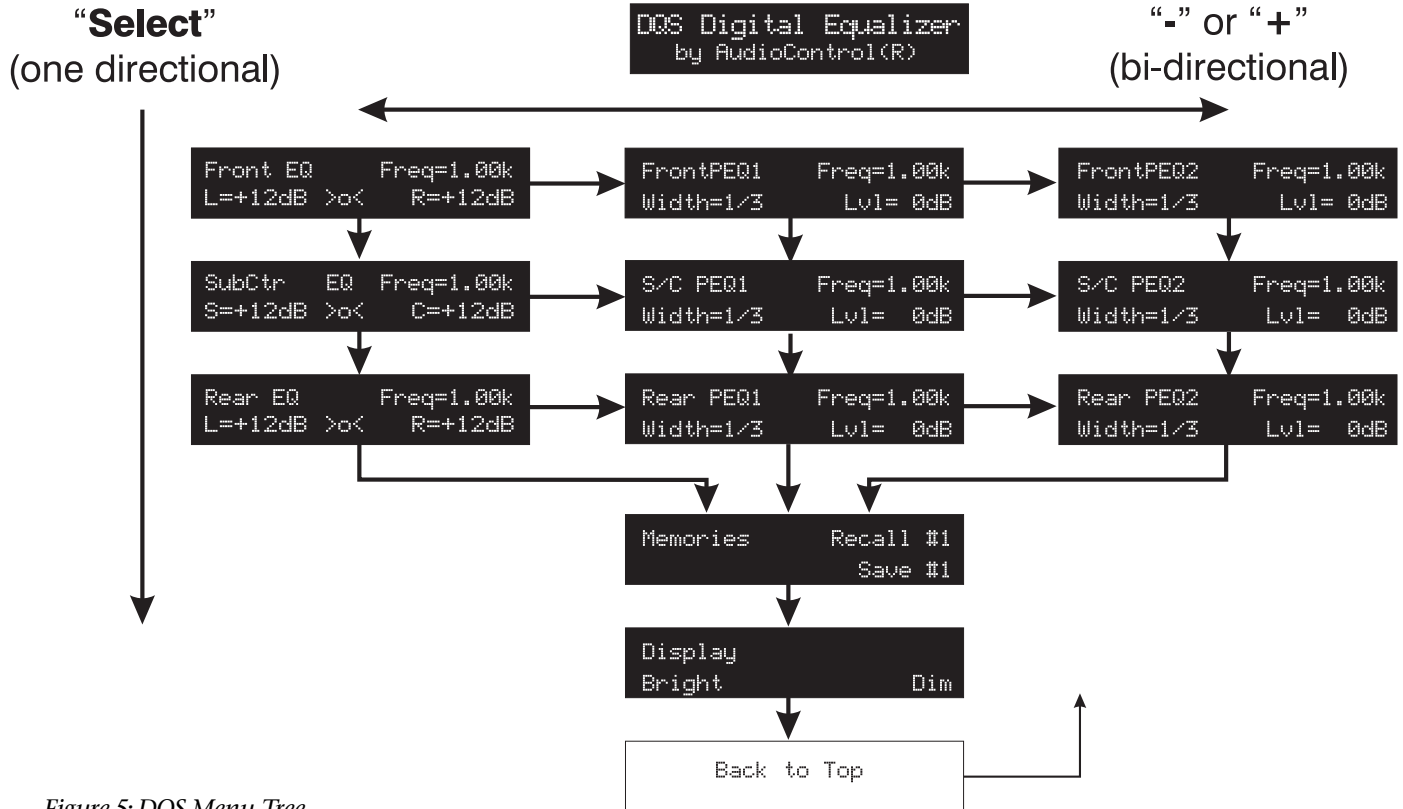

Figure 5: DQS Menu Tree

# The Strength of Digital™

**1) Digital Status Display** - This cool blue screen will tell you which mode your DQS is in.

**2) Select** - Every time you tap this button, you will scroll through the various modes in your DQS.

**3) “+” and “-” Navigation Buttons:** Depending upon where your cursor is flashing, these buttons will allow you to change the frequency, apply boost/cut and vary the bandwidth or “Q” of your equalization filters.

**4) Left and Right Navigation Buttons:** Within each mode there are several sub functions (i.e. Freq, Lvl, Width, etc.) that you can access using these buttons. By tapping on these buttons and watching the flashing cursor, you can navigate through each function on the screen.

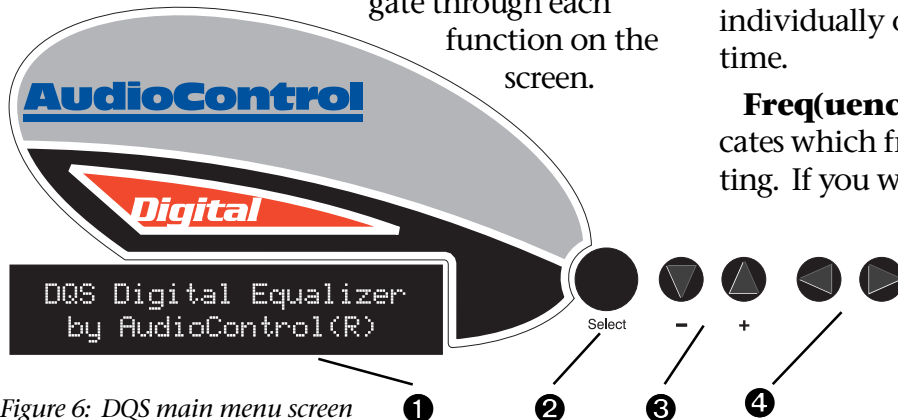

Figure 6: DQS main menu screen

## MODE: Front EQ, Rear EQ, SubCtr EQ

Front EQ      Freq = 1kHz  
L = +6dB      >o<      R = +4dB

Figure 7: Graphic EQ Screen

Your DQS has 30 built-in graphic equalization filters for each channel. These frequencies happen to match those on the AudioControl SA-3055 real time analyzer. In the Graphic EQ mode, you can select any of the 30 frequencies, one at a time, and apply boost or cut. The menu screens for your graphic equalizers are labeled **Front EQ**, **Rear EQ**, and **SubCtr EQ** respectfully. In addition you can select whether you want the equalization controls to affect the left and right channels individually or control both channels at the same time.

**Freq(ueency):** This corner of the screen indicates which frequency you are boosting or cutting. If you wish to select another frequency, tap the left or right arrow buttons until the cursor is flashing on the number next to “**Freq=**”. Then use the “+” and “-” controls to select the frequency to which you wish to apply boost or cut.

## Single or Dual Channel Equalization:

After you have selected a frequency to equalize, you must decide whether you wish to equalize the left channel, the right channel, or both channels simultaneously. If you are a first time user, we suggest you equalize both channels together at first and then individually. Use the arrow keys to move the cursor to one of the following positions:

- “**L**=” Equalizing on the left channel
- “>**o**<” Equalizing both channels simultaneously
- “**R**=” Equalizing on the right channel

When the cursor highlights this screen, you can now apply boost or cut, using the + and - controls, to the frequency you selected in the previous step.

Once you have made your equalization settings, you will want to tap the Select button, go to the Memories screen, and save your settings in one of the eight memory locations. Keep in mind you have the ability to equalize your Front, Rear, and Subwoofer/Center speakers individually.

## MODE: Front PEQ1, Rear PEQ1 and S/C PEQ1



```
FrontPEQ1   Freq=1.00k
Width=1/3   Lvl= 0dB
```

Figure 8: **Front PEQ1** screen

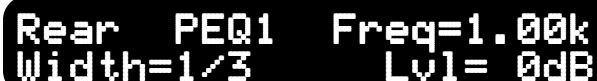

```
Rear PEQ1   Freq=1.00k
Width=1/3   Lvl= 0dB
```

Figure 9: **Rear PEQ1** screen



```
S/C PEQ1    Freq=1.00k
Width=1/3   Lvl= 0dB
```

Figure 10: **S/C PEQ1** screen

Besides having a 30-band graphic equalizer, your DQS also has two fully-programmable parametric bands for each pair of channels. These allow you to select a frequency, apply boost or cut, and change the bandwidth or “Q” of the filter.

**Front PEQ1** mode allows you to set the controls for the first of the front parametric equalizers while **FrontPEQ2** mode lets you change the settings for the second parametric bands.

**Freq(ueency):** This corner of the screen indicates which frequency you are boosting or cut-

ting. If you wish to select another frequency, tap the left or right arrow buttons until the cursor is flashing on the number next to “Freq=”. Then use the “+” and “-” controls to select the frequency to which you wish to apply boost or cut.

**Lvl:** When the cursor highlights this part of the screen, you can now apply boost or cut to both channels using the “+” and “-” controls. Please note that you do not have individual channel control using the parametric equalizers.

**Width:** This control lets you select how wide of an area each of the DQS’s parametric bands affects. You can choose a real narrow bandwidth, like 1/12 th of an octave or go as wide as three full octaves.

## MODE : Memories

This screen allows you to save or recall settings to *or* from one of the eight memory locations. Using the Left and Right arrows will cause the cursor to highlight one of the following functions:

**Recall:** When the cursor is flashing next to this word, you have the ability to recall one of the eight memories. Push the “+” or “-” buttons to scroll through the memories and select a memory to recall.

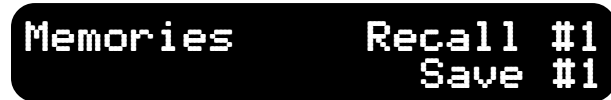

Figure 11: Memory screen

**Save:** Once you have made your equalization settings, you will want to save them in one of the eight memory locations. When the cursor is flashing next to the word “Save”, use the “+” or “-” buttons to select a memory location. Once you have selected a memory location, tap either the “Left” or “Right” button and the cursor will move to the bottom left of the screen between “N(-)” and “Y(+)”. Tap the (+) button to complete the saving process or tap (-) to quit.

Please note that while you are **RECALLING** or **SAVING** a memory, the cursor will stop blinking. Once the processor has **SAVED** or **RECALLED** all your settings, it will begin flashing again.

## MODE: Display



Figure 12: Display brightness screen

In this mode, you have the ability to change the brightness levels on the display of your DQS. Using the left and right navigation buttons you can toggle back and forth between “Bright” and “Dim”. Once you have selected a brightness level you are comfortable with, tap the “Select” button and your last brightness setting will be retained.

## ADJUSTING THE EQUALIZER

When it comes to music, everyone’s taste is different. Some people want pounding bass and crisp, blood curdling highs. Others may prefer a “flat” response (whatever the heck that is). At the end of the day, most people just want their system to sound balanced, “just like it did in the store” or their buddy’s car. The following equalization guidelines should help you achieve your own personal audio nirvana.

1) For optimum performance, get your hands on a test compact disc that contains pink noise and a good quality RTA (real-time analyzer); we happen

to know someone who makes a really good one. If you cannot locate an RTA, you probably want to have your authorized AudioControl dealer perform the equalization adjustments, as they will likely have an analyzer. You can certainly adjust your DQS using your ears, however an RTA will give you the best results.

2) Begin playing pink noise through your system and place the microphone for your analyzer on a microphone stand in the driver’s seat. Take a careful look at the “curve” on your analyzer and how one frequency combines with the next.

There is no one curve that will satisfy every person, as we all have different tastes. (How else can you explain Liberace, Brittany Spears or rice cakes?) The key is to use your DQS to help balance your system from one frequency to the next and give your speakers the sparkle, sizzle, detail or punch that the acoustics of the car have compromised.

3) Start equalizing by removing any large bumps, peaks, or areas with too much energy at a particular frequency. Next, boost the ranges that do not have enough energy. We strongly recommend that you cut or decrease energy before you boost. Try to keep any boosts to +6dB or less for best performance.

# The Strength of Digital™

4) Although the plethora of controls on your DQS can be intimidating, fear not; they were designed to give enough control to maximize your system's performance but not enough to get you in trouble. Here is an explanation of the key areas you should focus on:

**Sub-bass: 100 Hz and below** - A car without bass is like a day without sunshine...unless you live where we do because most of the days in the Pacific Northwest do not have sunshine. Bass is one of the more critical areas and it is also one of the most difficult to properly reproduce. Most people prefer their bass frequencies to be 6 to 9 dB louder than the rest of their system, although there are some crazy folks that prefer their bass substantially louder. The key in this area is to have enough speakers and power to produce the amount of bass you desire. But don't use the controls on the DQS to try and force your speakers to produce sounds they can't. Too much bass boost creates a condition called "speakerus explodus", which is not pretty to hear or watch.

**Midbass: 100 Hz to 300Hz** - The phrase, "too much of a good thing", can certainly apply to the midbass frequencies. This is the transition area of the audio spectrum that is an octave above your sub-bass frequencies and several octaves below your midrange. Most autosound systems have too much mid-bass due to the fact that speakers mounted in the doors or kick panels cause resonances or peaks in the response curve. These peaks in the mid-bass can actually mask or block sounds in the all-important midrange area causing your system to sound dull and lifeless.

**Midrange: 300Hz to 3kHz** - Musical instruments, vocals, mid-range percussion and many things we associate with imaging and staging happen in this area of the bandwidth. For that reason you will want to keep this area as smooth

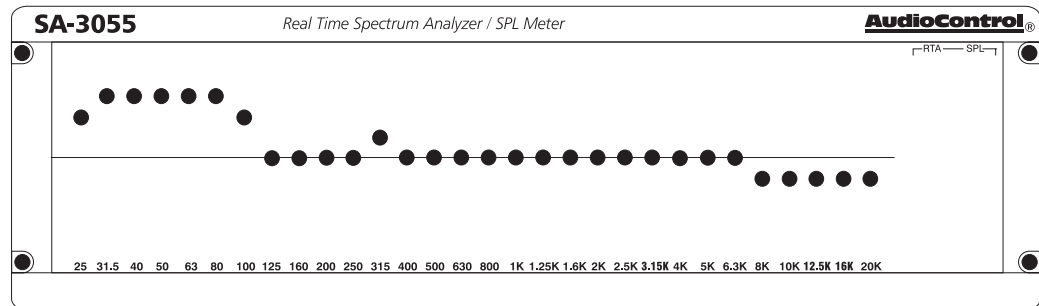

Figure 13: Sample RTA curve

# AudioControl®

---

and balanced as possible. Too much boosting can make you feel like you are listening to your system in a tile bathroom. Not enough energy in the midrange sounds empty and dry.

**Treble: 3KHz and Up** - If midrange is the cake, then these high or upper frequencies are the frosting. Many autosound systems start a gradual decline in this area which is why speaker placement is very important. The DQS only gives you a few controls in this area because too much boosting can really make a speaker sound unnatural.

## TROUBLESHOOTING

**No Power:** If the blue display on your DQS will not turn on, check to make sure that the power wire and remote turn-on wires are connected properly or a fuse has not blown.

**System Sounds Unbalanced:** Check your graphic and parametric equalization settings to make sure that one channel is not dramatically different than another.

**Sounds Distorted:** Should your system sound distorted or your speakers are moving way too much, you should make sure you have your levels matched properly and that your amplifier gains are set at minimum. If this checks out okay, you will want to look at your EQ controls to insure

that your boost levels are not overly boosted.

**Still Sounds Distorted:** Look at the frequencies that you have selected for **FrontPEQ1** and **FrontPEQ 2** and see how much boost or cut you have applied. Then look at those same frequencies on your Graphic EQ. If you have boost applied to the same frequencies on both types of equalizers, there is a strong chance you are overdriving your speakers and amplifiers at that frequency.

**Output Voltage LEDs Don't Light Up:** If your system is playing music but none of the output LED's are on, there is a good chance that the output voltage of your source unit is not that strong. Now before you call us and say, "The guy at the store said my radio has high-voltage output", you might want to face the fact that there is "Engineering Voltage" and there is "Marketing Voltage". Without picking on any particular source unit, remember that you do get what you pay for.



# The Strength of Digital™

## UNDER THE COVER

**1) Input Grounding:** For many systems you can leave this jumper in the UNBALANCED position. In other systems, the source unit may look for a ground through the RCA connection to the amplifier and create a ground loop, which in turn can cause a whine (not the type that comes in a bottle) in your system. In that event, you should set at least one of the three jumpers to the BALANCED position.

**2) Ground Isolation Selector:** Occasionally alternator noise may appear in a system because the source unit and amplifier are using different grounding schemes. To help in this situation, we have provided alternative grounding connections. Make sure your system is turned OFF before you move these jumpers.

	<b>Shipped</b>	<b>Options</b>
Input Grounding	Unbalanced	Balanced
Ground Isolation	Isolated	200 ohms or Ground
Choice of beverage	Micro-brew	Latté

## IF YOU LIKE THE DQS, YOU'LL LOVE...

The AudioControl Digital Dash Control (or DDC as it is called by its closest friends) is an optional remote-mountable control for your DQS. The DDC can be installed almost anywhere in your vehicle and then connected to your DQS via cable. This allows you to make all of your equalization settings from the convenience of your front seat as well the chassis of your DQS. In addition with the DDC, you can see “many colors” without any hallucinogenics by changing the display colors and backlighting.



*AudioControl DDC - Digital Dash Control*

# AudioControl®

---

And now a word from the legal department.

## THE WARRANTY

People are scared of warranties. Lots of fine print. Months of waiting around. Well, fear no more, this warranty is designed to make you rave about us to your friends. It's a warranty that looks out for you and helps you resist the temptation to have your friend, "...who's good with electronics", try to repair your AudioControl product. So go ahead, read this warranty, and then take a few days to enjoy your DQS before sending in the warranty card and comments.

"Conditional" doesn't mean anything ominous. The Federal Trade Commission tells all manufacturers to use the term to indicate that certain conditions have to be met before they'll honor the warranty. If you meet all of these conditions, we will warrant all materials and workmanship on your DQS for one year from the date you bought it (five years if it is installed by an authorized United States AudioControl dealer). We will fix or replace it, at our option, during that time.

Here are the conditional conditions:

1. You have to fill out the warranty card and send it to us within 15 days after purchasing your DQS.

2. You must keep your sales receipt for proof of purchase showing when and from whom the unit was bought. We're not the only ones who require this, so it's a good habit to get into with any major purchase.

3. Your DQS must have originally been purchased from an authorized AudioControl dealer. You do not have to be the original owner, but you do need a copy of the original sales slip.

4. You cannot let anybody who isn't (A) the AudioControl factory; (B) somebody authorized in writing by AudioControl to service your DQS. If anyone other than (A) or (B) messes with your DQS, that voids your warranty.

5. The warranty is also void if the serial number is altered or removed, or if your DQS has been used improperly. Now that sounds like a big loophole, but here is all we mean by it.

Unwarranted abuse is (A) physical damage (don't use the DQS for a jack stand); (B) improper connections (120 volts into the power jack can fry the poor thing); (C) sadistic things. This is the best mobile product we know how to build, but if you mount it to the front bumper of your car, something will go wrong.

6. If an authorized United States AudioControl dealer installs your DQS, the warranty is five years; otherwise the warranty is one year.

Assuming you conform to 1 through 6, and it really isn't all that hard to do, we get the option of fixing your old unit or replacing it with a new one.

## LEGALESE SECTION

This is the only warranty given by AudioControl. This warranty gives you specific legal rights that vary from state to state. Promises of how well the DQS will perform are not implied by this warranty. Other than what we have covered in this warranty, we have no obligation, express or implied. Also, we will not be obligated for direct or indirect consequential damage to your system caused by hooking up the DQS.

Failure to send in a properly completed warranty card negates any service claims.

## DQS SPECIFICATIONS

All specifications are measured at 14.4 VDC (standard automotive voltage). As technology advances, AudioControl reserves the right to continuously change our specifications like our weather.

Maximum input level .....	7.5 Vrms
Maximum output level .....	7.5 Vrms
Output gain .....	±10dB
Frequency response .....	10Hz-22kHz
Total harmonic distortion .....	0.01%
Signal to Noise ratio .....	105dB
Balanced input noise rejection .....	60dB
Input Impedance .....	20k Ohms
Output Impedance .....	150 Ohms
Graphic Equalization Controls .....	30 bands, 25 Hz - 20 kHz ISO 1/3 octave centers
Parametric Equalization Controls .....	2 bands, 25 Hz - 20 kHz ISO 1/12 octave Adjustable Centers
Parametric Equalization Bandwidth .....	1/12 to 3 octaves
Equalization boost/cut .....	±12 dB
Power supply .....	High headroom PWM switching
Power draw .....	600mA
Recommended fuse rating .....	2 Amp
Size .....	1.25" W x 9.9"D x 7"H
Weight .....	3.5 lbs.
Country of origin .....	USA

# **AudioControl®**

---

©2004, AudioControl, a division of Electronic Engineering and Manufacturing, Inc. All rights reserved. AudioControl, Making Good Stereo Sound Better, DQS, DQX, DQT, DDC and DXS, are all trademarks of Electronic Engineering and Manufacturing, Inc.

This manual was conceived, designed, and written on several bleak, windy, and dreary rain-drenched days at our home in the Pacific Northwest Rainforest outside of Seattle, Washington. The lattes were hot and the wheat beers were cold like our weather.

**AudioControl®**

22410 70th Avenue West

Mountlake Terrace, WA 98043 USA

Phone: 425-775-8461

Fax: 425-778-3166

[www.audiocontrol.com](http://www.audiocontrol.com)

***Owner's Enjoyment Manual***