



## Magnum DS8016

# 10 / 100Mb Dual-Speed Stackable Hubs



## Installation and User Guide



# Magnum™ DS8016 10/100Mb Dual-Speed Stackable Hubs

## Installation and User Guide

Part #: 84-00120, Rev. C (04/01)

### Trademarks

Ethernet is a trademark of Xerox Corporation

NEBS is a trademark of Telcordia Technologies

UL is a registered trademark of Underwriters Laboratories

**GarrettCom, Magnum** and **Personal Switch** are trademarks and **Personal Hub** is a registered trademark of GarrettCom, Inc.

**Important:** The Magnum DS8016 10/100 Dual Speed Stackable Hubs family contains no user serviceable parts. Attempted service by unauthorized personnel shall render all warranties null and void. If problems are experienced with Magnum DS8016 10/100 Dual Speed Stackable Hubs, consult Section 6, Troubleshooting, of this User Guide.

Copyright © 2006 GarrettCom, Inc. All rights reserved. No part of this publication may be reproduced without prior written permission from GarrettCom, Inc.

Printed in the United States of America.

**Contacting GarrettCom, Inc**

Please use the mailing address, phone and fax numbers and email address listed below:

GarrettCom, Inc.  
47823 Westinghouse Dr.  
Fremont, CA 94539-7437  
**Phone (510) 438-9071**  
Fax (510) 438-9072  
Website: <http://www.GarrettCom.com>

***email support@garrettcom.com***

**Federal Communications Commission****Radio Frequency Interference Statement**

*This equipment generates, uses and can radiate frequency energy and if not installed and used properly, that is in strict accordance with the manufacturer's instructions, may cause interference to radio communication. It has been tested and found to comply with the limits for a Class A computing device in accordance with the specifications in Subpart J of Part 15 of FCC rules, which are designed to provide reasonable protection against such interference when operated in a commercial environment. Operation of this equipment in a residential area is likely to cause interference, in which case the user at his own expense will be required to take whatever measures may be required to correct the interference.*

# The Magnum Line

## ETHERNET CONNECTIVITY PRODUCTS

"DESIGNED AND MANUFACTURED IN THE USA"

### OVERVIEW

GarrettCom, Inc. offers the premium-quality Magnum™ line of Ethernet LAN connectivity products with industry-standard functionality and built-in fiber configurability. Magnum products are designed for use in demanding Carrier Class, Industrial Grade and OEM applications where reliability is a primary consideration.

**4K-Series Switches, 100 & 10Mbps, copper ports with optional fiber port, with auto-negotiating full switching performance**

**Quad-Series Fiber Switches, 100 & 10Mbps, fiber and copper ports, mixed-speed and mixed-media types, full switching performance**

**“Outdoor” Ethernet Switch, for temperature uncontrolled locations**  
6 10/100 and 2 100Mb fiber ports, can be connected in strings

**Mixed-Media Fiber Hub, 16-port Stackable, 10/100 auto-sensing**

**Dual Speed 8-port and 16-port Stackables, 10/100 auto-sensing**  
**Stackable Hubs, SNMP Optional**

10Mb series and 100Mb series, both w/ optional port modules

**Personal Switches, 10/100Mb**

8 port dual speed, Auto-negotiable with fiber option

**Personal Hubs, 100Mb or 10/100Mb**

8-port, with two switched ports (1 fiber built in)

**Personal Hubs, 10Mb series**

8-port + AUI, stackable to 5 high, + optional BNC or fiber port

8 or 9-port and 4 or 5-Port Personal Hubs, w/ man. up-link sw.

**Media Converters, 10Mb and 100Mb series**

All media combinations, incl. fiber ST, SC, mm., single mode

**The “X-line” of configurable Mixed Media products:**

**Stackable Concentrators, SNMP optional, 13-Ports**

**Mini-Concentrators, 7 Ports, Repeaters, 2-Ports**

**Repeater Port Modules (RPMs), 6 types for Ethernet media**

**Bridge Port Modules (BPMs), 4 types, for segment isolation**

**Fan-Outs, 10Mb series**

2, 4 and 8 Port Models

**Transceivers, 10Mb and 100Mb series** 10Mb Mini-Transceivers and  
Coax Models, All Types -

July, 06

<b>TABLE OF CONTENTS</b>	<b>PAGE 1</b>
<b>1.0 SPECIFICATIONS</b> .....	<b>1</b>
1.1 Technical Specifications .....	1
1.2 Ordering Information .....	3
<b>2.0 INTRODUCTION</b> .....	<b>4</b>
2.1 Inspecting the Package and Product.....	4
2.2 Product Description - General.....	5
2.2.1 Magnum DS8016 Chassis .....	6
2.2.2 10 / 100 Speed Auto-sensing .....	7
2.2.3: Magnum DS8016-E model, 100Mbps -only .....	8
2.2.4: DS8016-R “reverse” model, front LEDs and conn in rear .....	8
2.3 Stacking Magnum DS8016s.....	9
2.4 Bridge Module between the 10Mb and 100Mb Domains .....	10
2.5 Up-link, Port 1X for Cascading .....	10
2.6 Features and Benefits .....	11
2.7 Applications .....	12
<b>3.0 MAGNUM DS8016 INSTALLATION</b> .....	<b>15</b>
3.1 Locating Magnum DS8016 Dual-Speed Hubs.....	15
3.1.1 Table-Top or Shelf Mounting .....	15
3.1.2 Rack-Mounting.....	16
3.2 Connecting Ethernet Media.....	17
3.2.1 Connecting Twisted Pair .....	18
3.2.2 Attaching to the MII port in the rear .....	18
3.2.3 100Mbps Cable Distances and PDV Calculations .....	18
3.2.4 Connections to NICs which support Auto-Negotiation .....	21
3.3 Powering the Magnum DS8016.....	21
<b>4.0 OPERATION</b> .....	<b>22</b>
4.1 Dual-Speed and Domain-Switched Functionality.....	22
4.2 Auto-negotiation and speed-sensing .....	25
4.3 LED’s.....	25
4.4 Up-link Port 1X.....	26
<b>5.0 TROUBLESHOOTING</b> .....	<b>27</b>
5.1 Before Calling for Assistance .....	27
5.2 When Calling for Assistance.....	28
5.3 Return Material Authorization (RMA) Procedure .....	28
5.4 Shipping and Packaging Information.....	29
<b>APPENDIX A: WARRANTY INFORMATION</b> .....	<b>29</b>
<b>APPENDIX B : OPTIONAL 48V DC POWER SUPPLY, ADDENDUM..</b>	<b>30</b>
<b>APPENDIX C: OPTIONAL 48V DS DC POWER, ADDENDUM.....</b>	<b>32</b>

**R07/06:** Updated Rack-mounting and Appendix B & C with 24VDC and 125VDC Power Supply Option as per UL instructions.

**Rev C 04/01 :** Change the company’s name to GarrettCom, Inc.(formerly it was Garrett Communications). There are no changes made to the content material at this time.

**Rev B 03/99 :** Added Reverse model specifications and collision domain diameter, cable distances and pdv calculations

**Rev A 07/98 :** This revision is the initial release of the DS8016 10/100 Dual Speed Stackable Hubs user manual.





## 1.0 SPECIFICATIONS

### 1.1 Technical Specifications

100 or 10 Mb/s per port, auto-sensing for speed. DS8016 hubs support two traffic domains, one at 100Mb/s and one at 10Mb/s, have sixteen RJ-45 ports, and are stackable up to 3 units high operating as one repeater. In addition, a Media Independent Interface (MII) port is provided per unit (except on -R “reverse” models)

#### Performance

When a port is operating at 100Mb/s:

Data Rate: 100 Mb/s

PDV (Path Delay Value) : 80BT, exceeds Class II

When a port is operating at 10Mb/s: Data Rate = 10 Mb/s

Partitioning: Enforced after 63 consecutive collisions

Auto-reconnect: Occurs after one packet of error-free reception

#### Network Standards

100Mb: Ethernet IEEE 802.3u, 100BASE-TX

10Mb: Ethernet IEEE 802.3, 10BASE-T

Auto-sensing for speed: IEEE 802.3u

#### Packet-Processing Between Domains (internal 10/100 switch or bridge)

Filtering and Forwarding Rate from 100Mb ports: 148,800 pps max.

Filtering and Forwarding Rate from 10 Mb ports: 14,880 pps max.

Processing type : Store and Forward

Auto-learning : 8K address table, shared for both traffic domains

Packet buffers : 2MB, dynamically allocated & shared on both domains

Latency (not including packet time) : 100 to 10Mb : 5 $\mu$ s

10 to 100Mb : 5 $\mu$ s

CPU Type : State Machine

#### Maximum Ethernet Segment (or Domain) Lengths

10BASE-T (Unshielded twisted pair)- 100 m (328 ft)

100BASE-TX (CAT 5 UTP) - 100 m (328 ft)

#### Operating Environment

Ambient Temperature: 32°F to 122°F (0°C to 50°C)

Storage Temperature: -20°C to 70°C

Ambient Relative Humidity: 5% to 95% (non-condensing)

#### Power Supply (Internal)

AC Power connector : IEC-type, male recessed, rear of chassis

Power Input Voltage : 90 to 260 VAC (auto ranging)

Power Input Frequency : 47-63 Hz

Power consumption: 25 watts typical, 40 watts max. P.S. rating

**48VDC Power Supply (Optional)**

Power Input Voltage : 36 to 72 VDC (auto ranging)

Terminal Block in rear: “-, GND, +”

Power consumption: 25 watts typical, 40 watts max. P.S. rating

**Network Cable Connectors** - for the 16 RJ-45 shielded female ports per hub

100Mb: Category 5 UTP/STP

10Mb: Category 3, 4, 5 UTP (Note: speed-sensing does not sense cable type)

MII port: standard 40-pin female MII port connector in the rear (not on -R’s)

**Stacking Cable** - stacking may be up to three DS8016 hubs, or 48 RJ-45 ports. A stacking cable with 25 pin DB-25 connectors, shielded, 9 inch (23 cm) long, is included with each DS8016-A and -E Dual-Speed add-on unit. (No stacking connectors are built into the DS8016-R “reverse” model).

**Up-Link** - Use first RJ-45 port, which has two connectors (only one can be used at a time). Plug into # 1 for use as a regular user segment port, or into # 1X for use as a cross-over (X position) up-link port for connection to a central hub or another cascaded hub.

**Packaging**

Enclosure: High strength metal. Rack-mounting brackets included.

Suitable for wiring closet shelf, 19” rack or desktop mounting.

Dimensions: 1.75 in H x 17in. Wx9 in D ( 4.4cm x 43.2cm x 22.9cm)

Weight: 4.0 lb. ( 1.8 Kg)

Cooling method: Fan cooled, internal @ 9cfm

On-Off manual switch for AC or DC input power, located at power input

**LED Indicators**

PWR : Steady On when power applied

BR : Bridge Module Indicator, On when 10/100 bridge module is installed (Model DS8016-B,R), Off when no bridge module is inside (-A and -E)

COL : Collision LEDs, one each for 100Mb and 10Mb speed domains

100/Auto: Speed LED, per port. Steady On when speed is 100Mbps , Off when speed is 10Mb, flashing when auto-negotiating or not connected.

LK/RX : Activity LED per port. Steady On when twisted-pair link is operational Activity, flashing when port is receiving data.

**Agency Approvals**

Safety :UL Listed (UL 1950), cUL, CE

Emissions: meets FCC Part 15, Class A

**Warranty**

Three years, return to factory

Made in USA

## 1.2 Ordering Information

### Magnum DS8016 Dual-Speed Stackable Hubs

**Magnum DS8016-A:** Dual-Speed 10/100 Stackable Hub with sixteen RJ-45 ports, each auto-sensing for 100Mb or 10Mb operation. Stackable up to three units high, with all ports in one stack operating as two separate traffic domains, one domain at 100Mb/s and one domain at 10Mb/s. Includes stacking cable, internal auto-ranging power-supply, cooling fan, and metal brackets for shelf or wall mounting.

**Magnum DS8016-B:** Same as Magnum DS8016-A but includes an internal switch module that bridges the two traffic domains, filtering and selectively forwarding packets between the 100Mb and the 10Mb domains. Stacks up to two DS8016-A units. One DS8016-B unit stack supports all ports at 100Mb or 10Mb communicating with each other. The internal switch has 2Mb dynamic store-and-forward packet buffers and 8K node addresses.

**Magnum DS8016-E:** Same as Magnum DS8016-A but all ports operate at 100Mbps only (not dual speed-speed). Each port will auto-negotiate with an attached 10/100 device for 100Mbps speed and half-duplex mode only. May be used in DS8016 stacks, same as Model DS8016-A.

**Magnum DS8016-R:** Same as Magnum DS8016-B but with all ports on the rear side and all of the LEDs are on front panel. No stacking. Normally used with 48V DC dual source power supply, mounted in telco racks.

**RMB-23W:** Set of two mounting brackets that extend a standard 19" DS8016 hub for mounting in a 23" -wide telco rack, 1U high.

GarrettCom, Inc. reserves the right to change specifications, performance characteristics and/or model offerings without notice.

## **2.0 INTRODUCTION**

### **2.1 Inspecting the Package and Product**

Examine the shipping container for obvious damage prior to installing this product; notify the carrier of any damage which you believe occurred during shipment or delivery. Inspect the contents of this package for any signs of damage and ensure that the items listed below are included.

This package should contain:

- 1 Magnum DS8016-series Dual-Speed Hub unit
- 1 AC Power Cord (U.S. and other 115 vac locations only)
- 1 Stacking Cable, Model DS8016-A and -E add-on (no bridge inside) units only
- 1 Set of metal “Ears” for optional rack mounting
- 1 Installation and User Guide
- 1 Product Registration Card

Remove the Magnum DS8016 Dual-Speed Hub from the shipping container. Be sure to keep the shipping container should you need to ship the unit at a later date. To validate the product warranty please complete and return the enclosed Product Registration Card to GarrettCom, Inc. as soon as possible.

In the event there are items missing or damaged contact your supplier. If you need to return the unit use the original shipping container. Refer to Chapter 5, Troubleshooting, for specific return procedures.

## 2.2 Product Description - General

Magnum DS8016 Dual-Speed hubs have sixteen RJ-45 ports, each 10/100Mb auto-sensing \*. Each port can independently identify (via IEEE 802.3u auto-sensing) and accept either 100Mb or 10Mb Ethernet signals, adapting to match the best speed of the connected device. There are two internal traffic domains in Magnum DS8016 hubs, one for the 100Mb traffic and one for the 10Mb traffic. The 100Mb users share the 100Mb domain's bandwidth and the 10Mb users share the 10Mb domain's bandwidth.

\* **Note:** *the "special 100Mb-only" model DS8016-E is not dual-speed. See Section 2.2.3 below.*

Any DS8016 port can connect into either the 100 or the 10Mb traffic domain, and can also change from one traffic domain to the other at any time without affecting the speed of other ports. The automatic per-port speed-sensing is continuous (it takes place at LINK enable, see section 4.2 for details), allowing the connected devices to change speed at any time without impairing the operation of the other ports and connected devices.

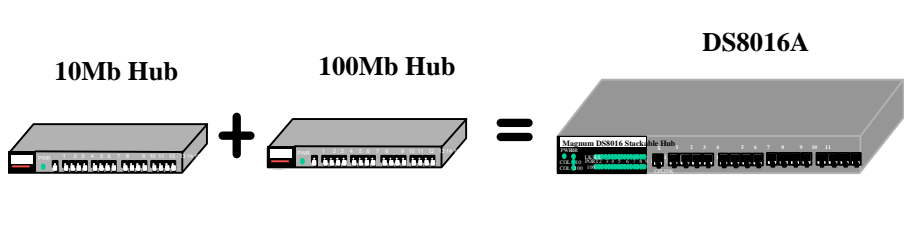
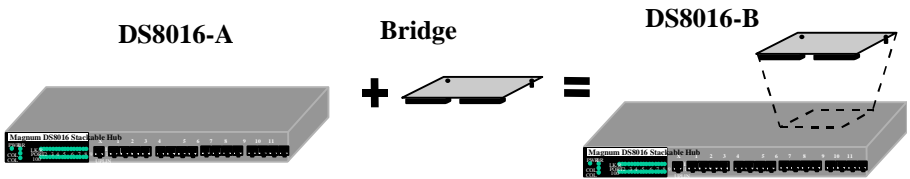

**Figure 2.2 a :** Magnum DS8016s are functionally both a 10Mb and a 100Mb hub in one

As Magnum DS8016 Dual-Speed units are stacked, the two shared traffic domains automatically expand to support all of the ports in the stack. Any combination of 10Mb and 100Mb ports, up to the maximum of 48 ports (3 units) in one stack, can be in use at any time.

Some DS8016 models, the Magnum DS8016-B and DS8016-R, include an internal bridge or switch module which interconnects the 10 Mb and the 100Mb traffic domains. This enables all users on a DS8016-B or -R hub or a DS8016 stack, whether 100Mb or 10Mb, to talk to each other. The internal switch of the DS8016's filters and selectively forwards packets between the 10Mb and the 100Mb domains, maintaining peak performance in each domain unaffected by local traffic in the other domain. The internal bridge is self-learning, with large address table capacity for up to 8K node addresses. As networked nodes are added or removed or move from one speed domain to the other, the DS8016-B's (or DS8016-R's) internal switch automatically keeps track.

Another DS8016 model, the DS8016-A, has no switch module inside, but is dual speed and is normally used stacked with a DS8016-B for dual-speed port expansion.



**Figure 2.2 b : The DS8016-B is a DS8016 with a bridge module built-in for 10 and 100Mb**

Only one DS8016-B unit is needed to support a stack. Additional 16-port units of the DS8016-A “add-on” and/or DS8016-E “100-only” hubs . . . units that do not have the bridge module inside, and which cost less accordingly . . . can be added to the stack, up to the 3-unit stack maximum. In a stack, the DS8016-B unit (illustrated below as the bottom unit) can be in any stack position.

**Figure 2.2 c : Stack of DS8016’s, 2@ DS8016-A’s and 1 @ DS8016-B**

DS8016-A units can also be used without a DS8016-B, whereupon they will function as dual-speed stackable hubs. This could be desired if an external non-auto-sensing switch (such as the Magnum 300ES Two-Port Switch) is available to interconnect the two speed domains, or if only 100Mb devices are connected (use the DS8016-E for this? See 2.2.3 below) and the 10Mb domain is unused, or if dual-speed operation with two unconnected and uncoordinated domains is needed for the application.

Each DS8016 has its own internal power supply, and is easily added to an existing 10 or 100Mb network. DS8016s are suitable for wiring closet shelf, table-top or 19” rack-mounting. Optional brackets for 23” telco rack-mounting are available.

### 2.2.1 Magnum DS8016 Chassis

The Magnum DS8016 chassis houses one main PC board, a bridge module daughter-board in the Model DS8016-B and DS8016-R, and an internal power supply unit. The front side of the chassis has sixteen RJ-45 twisted-pair ports, one of which (Port #1X on the left-front) can be used for cascading (UP-LINK).

LEDs to indicate operating status are on the front side. There are power (PWR) and bridge-inside (BR) indicators for the unit. There are collision (COL) indicators for each of the 10Mb and 100Mb domains, for visual indication of the operating status of each domain.



And there are link (LK/RX),

Partition and

### Magnum DS8016 Dual-Speed Hub

100M/Auto indicators for each port. (See Section 1.1 “Specifications” for a technical description of the LEDs). The unit has a cooling fan on the side which sends warm air out away from the unit to the side. Stacking cables connect in the rear, except for the DS8016-R model. (see Section 2.3 for stacking information).

The AC power cord connector, a universal recessed-male IEC type, is in the left rear of the chassis. The internal AC power supply is auto-ranging for any AC power input of 115 - 230 vac, 50 - 60 Hz. (An internal DC power supply is optional, see Appendix A).

### 2.2.2 10 / 100 Speed Auto-sensing

All sixteen RJ-45 twisted pair ports support auto-sensing for speed, independent of the other ports. Speed-sensing is performed by the DS8016’s electronics in accordance with the standards of the IEEE 802.3u auto-negotiation standard. If the connected device or node indicates that it is capable of 100Mb speed, then operation on that port will be at 100Mb/s. If the connected device does not positively indicate that it is capable of 100Mb speed, then the operation on that DS8016 port will be at 10Mbps. Of course, the hubs’ auto-negotiation technique is only for 10 / 100 speed, and does not provide for any full-duplex operation.

When a port is connected and LINK is present, the speed on that port that has been sensed by the DS8016 hub will be indicated by the ‘100M/Auto’ LED for that port. The ‘100’ LED is ON when 100Mb speed is sensed, and is OFF when 10Mb speed is in use. When a port is not connected, the ‘100M/Auto’ LED corresponding to that port will be blinking to indicate that it is trying to auto-negotiate. (See section 4.3 for operation of the LED’s).

### 2.2.3: Magnum DS8016-E model, 100Mbps -only

The Model DS8016-E is like the DS8016-A except that it's speed is internally fixed at 100Mbps on all ports. It is not dual-speed. It has no bridge inside. It is used for 100Mbps-only applications, and it can operate stand-alone or stacked with the other DS8016-B and DS8016-A models.

Special orders of this model can be built with some ports fixed at 10Mb. If your application requires a mix of fixed 100Mb and fixed 10 Mb ports, request a special quote.

### 2.2.4: Magnum DS8016-R “reverse” model, front LEDs and connections in rear

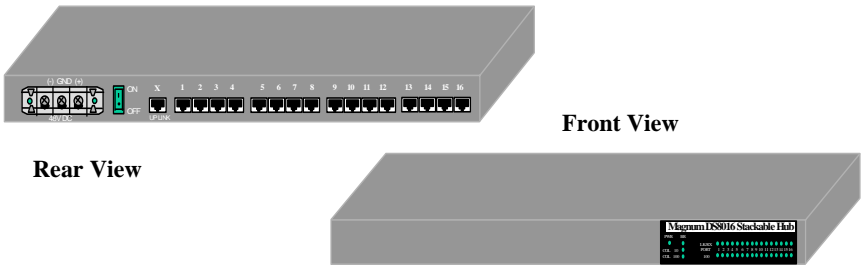

The Magnum DS8016-R is like the DS8016-B except that the front panel has the LEDs, and all the connecting ports and power feeds are in the back. This is convenient for rack-mounting where cabling is accessed from the rear of the rack while the operating status LEDs are monitored from the front. Typically such arrangements are found in telco rack installations.

The Magnum DS8016-R is dual-speed, and has a bridge module inside. The bridge module interconnects 10 Mbps and 100Mbps domains, allowing all connected users to talk to each other. The DS8016-R operates stand-alone, i.e., it is a non-stackable model. In addition, the MII port in the rear of other DS8016 models is not present for the DS8016-R.

Normally the DS8016-R is quipped with an optional internal 48VDC power supply (See Appendix A). There is an additional option of a dual-source 48V input (See Appendix B).

The DC power feed options and the high quality and versatility make the Magnum DS8016-R a good high-availability choice for telcos, ISPs, broadcast equipment, medical, brokerage firm and financial facilities. In applications where downtime of the operation is not acceptable, the DS8016-R provides a good Ethernet LAN solution.



### 2.3 Stacking Magnum DS8016s

Up to three Magnum DS8016s can be stacked to operate as one 10/100 dual-speed repeater with up to 48 dual-speed ports. Normally, one Magnum DS8016-B hub per stack is needed to provide a switched interconnection between the two separate 100Mb and 10Mb traffic domains in the stack. Additional stacked units are normally Model DS8016-A or -E “add-on” units, which cost less. The stacks can also include Magnum 8000X Fiber Hubs.

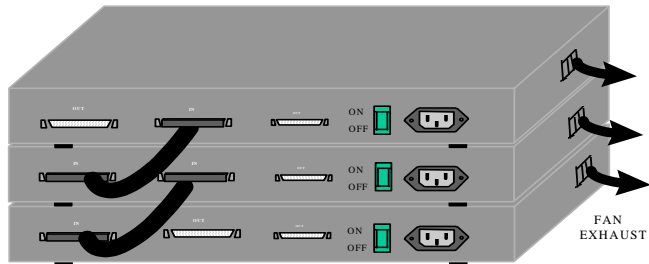

**Figure 2.3 : Magnum DS8016's stacked. Cables connect between “Out” and “In” Ports**

The DS8016-B models with the bridge module inside look the same as the DS8016-A or -E units (no bridge inside) from the outside. The “BR” LED on the front will light up when power is applied to indicate that a DS8016 is a -B (bridge inside) model. (The “BR” LED will be off if the unit is a Model DS8016-A or -E). The DS8016-B models cannot be stacked together, as their internal bridges would not be able to function properly when more than one is present. (Note that two DS8016-B units may be cascaded to operate together, however). Use DS8016-B models non-stacked, or with only 1 Model DS8016-B in a DS8016 stack. See Section 2.7, Example 3.

When stacking DS8016's, please make sure to use only the shielded 9-inch long stacking cable provided with each DS8016-A or -E unit. The cable length is designed to provide proper operation of up to three DS8016 units in a stack, and longer cables or unshielded cables are not permitted as they will not operate properly at 100Mb speeds.

When connecting DS8016s in a stack, use the stacking cable to connect the “Out” stacking port from one DS8016 unit to the “In” stacking port of the other. Push in the cable connectors until they seat in firmly. Also, leave space along the left-side (from the front) area for the exhaust of the internal cooling fan in each DS8016 unit. See Fig. 2.3 above.

## 2.4 Bridge Module between the 10Mb and 100Mb Domains

**Figure 2.4 : Internal view of DS8016-B  
with bridge module installed**

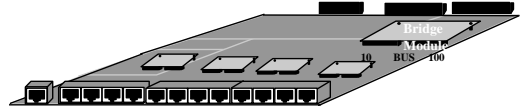

Magnum DS8016-B's and

DS8016-R's contain a factory-installed bridge module to interconnect the two traffic domains, filtering and selectively forwarding packets to allow only necessary packets to cross between the domains. This enables all of the users and nodes connected into either domain, whether 100Mb or 10Mb, to talk to each other, and it keeps local traffic on one domain from consuming any of the bandwidth of the other domain.

The bridge operates in the store-and-forward mode, which filters out bad packets and maintains optimum performance in both domains. Packet forwarding delay is only 5 $\mu$ s (plus packet time), much less than traditional store-and-forward bridge products, enabling the DS8016s to maintain high network performance. The bridge has 8K node address capacity, suitable for use in large networks. Addresses are self-learning so that filtering / forwarding of 10Mb and of 100Mb packets is maintained correctly even when users move their connection, or change speed, or power down.

The DS8016-B's and DS8016-R's bridge module is implemented as a daughter board. DS8016 units have an LED on the front labeled **BR** that will be **ON** when the module is installed internally. Power up any DS8016 unit, and if the **BR** LED is **ON**, it is a Magnum DS8016-B or DS8016-R unit.

**NOTE : Only one Magnum DS8016-B (with a bridge module built-in) is allowed per repeater stack. Thus, if the DS8016s in a stack have more than one BR (bridge) LED ON, it is an illegal configuration.**

## 2.5 Up-link, Port 1X for Cascading

The unit has an Up-link Port 1X, located on the left-front side of the hub. It enables the first port's RJ-45 cable to either connect to a user station ( port 1) or to be cascaded to another hub (port 1X) with cross-over. (See Section 4.4 for more details about Up-link). Like all DS8016 ports, Port # 1X is a dual-speed port which will sense the speed of the connected device. Use port 1X on one DS8016 and port 1 (or any port) on the second, i.e., use only one crossover port for the cascaded hubs connection. When the Up-link port is used

to cascade two DS8016 hubs or stacks together, the auto-sensing feature will cause the connecting link to operate at 100Mb speed.

## 2.6      **Features and Benefits**

### ■      **Supports 10 or 100Mb network connections on each of sixteen RJ-45 ports**

Magnum DS8016 Dual-Speed 10 / 100 hubs combine two logical hubs . . . one at 10Mb and one at 100Mb . . . in one physical box supporting two traffic domains. Each port can operate at either 10 or 100Mb, independently of the other ports.

### ■      **Auto-sensing for speed, 10 or 100Mb on each port**

All ports support 10/100 auto-negotiation for speed, operating separately on each port. Any mix of 10Mb and 100Mb users can be connected to the ports. Speed-sensing occurs at LINK-enable independently on each port. Individual ports can change to 100Mb or 10Mb speed at any time (LINK off, then on again), adapting automatically to any changes in the connected device's speed. Speed-sensing complies with IEEE 802.3u, providing interoperability with other products.

### ■      **An internal switch connects the 10 and 100Mb domains on Model DS8016-B**

Model DS8016-BAND DS8016-R has an internal switch for filtering / forwarding traffic between the 10 and 100Mb domains, allowing all connected devices to communicate to each other. High performance switching provides full bandwidth in each domain, unaffected by local traffic on the other domain. One DS8016-B per stack supports switching for all ports.

### ■      **Stackable for flexible expansion**

Magnum DS8016s can be stacked up to three units high for 48 ports, each 10 / 100 dual speed. As additional units are added in a stack, 10 and 100Mb traffic domains are expanded automatically to support the new ports at either 10 or 100Mb speed.

### ■      **Installation is "Plug and Play", Operation is Transparent to Software**

The Magnum DS8016-B operates as a hardware switch, only forwarding those packets from each domain that are needed on the other domain. Internal address tables are self-learning, enabling users to change port connections or 10 / 100 domains without affecting operations. The switch in the DS8016-B will not affect any standard software applications or SNMP network management platforms.

## 2.7 Applications

**Example 1 :** A Magnum DS8016-B serves a small office with mixed speed requirements. Some users operate at 100Mb, and some users and utility devices (such as print servers) run at 10Mb. All share the same hub, and talk to each other via the bridge module inside. Any node can change speed at any time without affecting network operation or impacting other users.

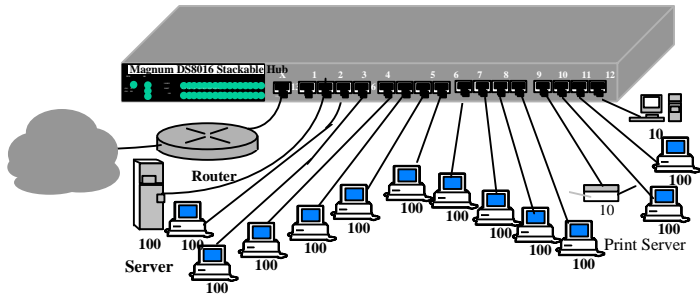

**Figure 2.7.1 : DS8016-B connects combinations of 10Mb and 100Mb network devices**

**Example 2 :** Where there are existing 10Mb hubs and users, they can easily be cascaded into any port of the DS8016-B. This allows simple plug-and-play addition of 100Mb ports to an existing 10Mb network without having to change it. Nodes that are capable of 100Mb speed can be moved to any DS8016 dual-speed port, and will automatically operate at the higher speed. The dual-speed ports on the DS8016-B can be used for adding 100Mb users or for accommodating existing high performance users. The 100Mb traffic does not use the bandwidth of the 10Mb domain, so overall performance of the network is improved.

**Figure 2.7.2 : DS8016-B adds a new 100Mb domain to existing 10Mb network**

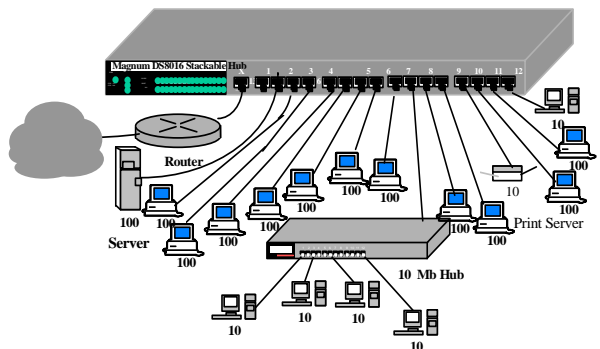

**Example 3 :**

For additional expansion, DS8016s can be expanded by stacking DS8016-A “add-on” units. The additional stacked ports are all auto-sensing dual-speed domain-switched, and can be used at either 10Mb or 100Mb on a per-port basis.

The stacking cables connect the DS8016 units and carry the signals for both the 100Mb and the 10Mb domains. In a stack, all 10Mb ports are together in a 10Mb traffic domain while all 100Mb ports are similarly together on a separate 100Mb traffic domain. When one DS8016-B unit with a bridge inside is present in a stack, its bridge will support all of the ports in the stack and enable network traffic to move between the two stacked domains.

A Magnum DS8016 stack operates as one dual-speed repeater. A dual-speed repeater is both a 10Mb hub and a 100Mb hub at the same time. This means that the 10Mb traffic domain obeys all of the rules of 10Mb shared Ethernet networks (hop counts, cable types, cable distances, etc.) and can be treated as one 10Mb repeater accordingly. Separately, the 100Mb traffic domain obeys all of the rules of 100Mb Fast Ethernet shared networks (hop counts, PDVs, cable types, cable distances, etc.) and can be treated as one 100Mb repeater. Both traffic domains function within the same physical DS8016 hub or stack of hubs.

**Figure 2.7.3 :**  
**Stack of Magnum**  
**DS8016's operate**  
**as one 10/100**  
**dual-speed**  
**repeater**

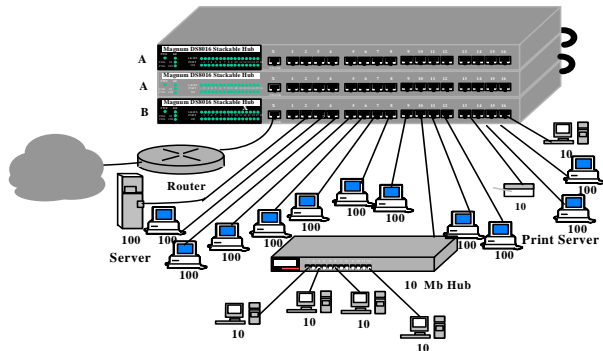

When expanding an Ethernet or Fast Ethernet installation, the Magnum DS8016 Hubs are ideally suited for connecting servers and stations that have (or may have in the future) mixed speeds. Each traffic domain or segment has its own local traffic with the Magnum DS8016-B performing bridge-isolation of one domain from the other, filtering and selectively forwarding 10Mb and 100Mb packets between the two domains. This keeps the traffic between the domains to a minimum and provides peak performance on both domains.

**Example 4:**

A Magnum DS8016-R serves a good solution for the user, who expect a high-availability, neat networking connection with clear visible display of LEDs port. Specially a place where existing network is supporting 10Mbps user and want to expand the network with 100Mbps fast ethernet. Magnum DS8016-R equipped with bridge module provide a very effective and reliable solution for these users.

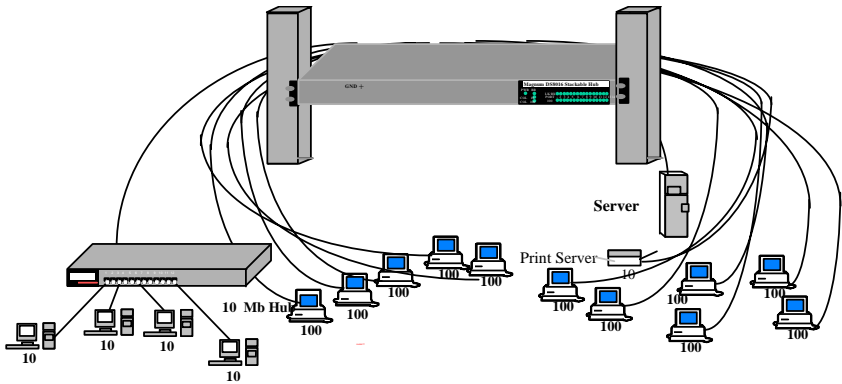

**Magnum DS8016-R connects 10Mbps and 100Mbps domain with front LEDs display**

In a Telecommunication co. the user expects a very reliable and high availability system, which provide them the ability to join their existing 10Mbps network with fast ethernet. The Magnum DS8016-R based on Dual-Speed with bridging facility communicate smoothly between 10Mbps and 100Mbps . The front panel LED display and rear port connection gives an adding advantage to run the neat network setup and help the user to trace out the defective port easily. Magnum DS8016-R has an another adding feature to run at Dual-source 48VDC, that gives a high availability and secure network.

### 3.0 Magnum DS8016 Installation

Before installing the equipment, it is necessary to take the following precautions:

- 1.) If the equipment is mounted in an enclosed or multiple rack assembly, the environmental temperature around the equipment must be less than or equal to 50°C.
- 2.) If the equipment is mounted in an enclosed or multiple rack assembly, adequate air flow must be maintained for proper and safe operation.
- 3.) If the equipment is mounted in an enclosed or multiple rack system placement of the equipment must not overload or load unevenly the rack system.
- 4.) If the equipment is mounted in an enclosed or multiple rack assembly, verify the equipment's power requirements to prevent overloading of the building/s electrical circuits.
- 5.) If the equipment is mounted in an enclosed or multiple rack assembly verify that the equipment has a reliable and uncompromised earthing path.
- 6.) If the intra-building wiring (cabling) is involved with this product (NEBS), then it is recommended to have shielded cable and the shield is grounded at both ends.
- 7.) This equipment is for installation only in a Restricted Access Location (dedicated equipment room service closet and the like) in accordance with the National Electrical code.

**Installation:** This chapter provides instructions for installing the Magnum DS8016 hubs.

#### 3.1 Locating Magnum DS8016 Dual-Speed Hubs

The location of a Magnum DS8016 Dual-Speed Hub is dependent on the physical layout of the network. Typically the hub is placed where combinations of 10Mb and 100Mb network devices need to be connected to communicate with each other. The 19" rack width size of the unit allows it to be conveniently placed in a wiring closet, an office or a lab area, and it can also be either shelf- or rack-mounted. (See instructions in 3.1.2 below). Rack-mounting brackets are included with each unit.

Locate an AC receptacle that is within six feet (2 meters) of the intended Magnum DS8016 site. The rugged metal case of the Magnum DS8016 will normally protect it from accidental damage in a lab or workplace setting. Maintain an open view of the front to visually monitor the status LEDs. Keep an open area around the unit so that cooling can occur from the small fan on the left side while the unit is in operation.

##### 3.1.1 Table-Top or Shelf Mounting

The Magnum DS8016 Dual-Speed Hub can be easily mounted on a table-top or any suitable horizontal surface, and has four rubber feet to provide stability without scratching finished surfaces.

### 3.1.2 Rack-Mounting

Installation of a Magnum DS8016 Stackable Hub in a 19" rack is a simple procedure. The units are 1U (1.75") high, including the rubber feet underneath. When properly installed, the front-mounted LED status indicators should be in plain view and easy to read. Rack-mount installation requires special rack-mounted brackets and screws (included with each DS8016). The brackets attach to the front sides of the hub, which is then fastened into a standard 19" rack.

**Figure 3.1.2: Magnum DS8016 with Rack-Mount**

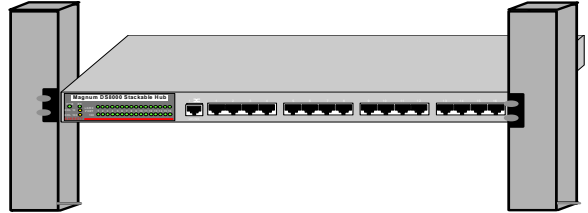

#### Brackets attached.

The 23" brackets and ETSI brackets are also available (optional) for Rack-mounting of Magnum 8000 units. The 23" brackets are more popular in the Telco industry where they are a standard for Central Office Rack-mounting purposes. The 23" brackets are mainly used for larger equipment assemblies in rack mounting frames, and are frequently accessed in operation from both sides.

The ETSI (European Telephone Standard) brackets are similar to the 19" brackets but use metric dimensions.

The optional 23" brackets and the ETSI brackets come as a pair in a package along with the necessary screws for attaching the brackets to the sides of the Magnum Hub unit.

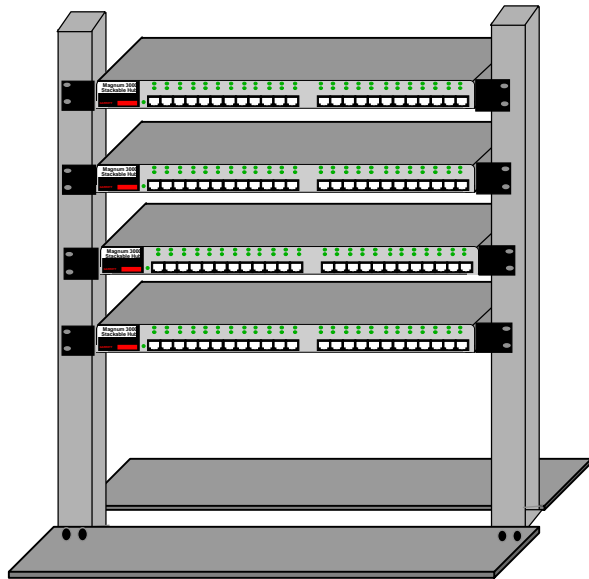

**Fig 3.1 Multiple Magnum 8000 units rack-mounted in a 23" Rack-mount frame**

The following instructions need to be follow up before installations-

- A) Elevated Operating Ambient - If installed in a closed or multi-unit rack assembly,



the operating ambient temperature of the rack environment may be greater than room ambient. Therefore, consideration should be given to installing the equipment in an environment compatible with the maximum ambient temperature (T<sub>ma</sub>) specified by the manufacturer.

B) Reduced Air Flow - Installation of the equipment in a rack should be such that the amount of air flow required for safe operation of the equipment is not compromised.

C) Mechanical Loading - Mounting of the equipment in the rack should be such that a hazardous condition is not achieved due to uneven mechanical loading.

D) Circuit Overloading - Consideration should be given to the connection of the equipment to the supply circuit and the effect that overloading of the circuits might have on overcurrent protection and supply wiring. Appropriate consideration of equipment nameplate ratings should be used when addressing this concern.

E) Reliable Earthing - Reliable earthing of rack-mounted equipment should be maintained. Particular attention should be given to supply connections other than direct connections to the branch circuit (e.g. use of power strips)."

### 3.2 Connecting Ethernet Media

The Magnum DS8016 Dual-Speed Stackable Hubs can be connected to the following two media types: 100BASE-TX and 10BASE-T. CAT 5 cables should be used when making 100BASE-TX connections. When the ports are used as 10BASE-T ports, CAT 3 may be used. In either case, the maximum distance for unshielded twisted pair cabling is 100 meters (328 ft).

<u>Media</u>	<u>IEEE Standard</u>	<u>Connector</u>
Twisted Pair (CAT 3, 4, 5)	10BASE-T	RJ-45
Twisted Pair (CAT 5)	100BASE-TX	RJ-45

**NOTE :** It is recommended that high quality CAT. 5 cables (which work for both 10Mb and 100Mb) be used whenever possible in order to provide flexibility in a mixed-speed network, since dual-speed ports are auto-sensing for either 10 and 100Mb/s.

### 3.2.1 Connecting Twisted Pair (RJ-45, CAT 3 or CAT 5, Unshielded or Shielded)

The following procedure describes how to connect a 10BASE-T or 100BASE-TX twisted pair segment to the RJ-45 port. The procedure is the same for both unshielded and shielded twisted pair cables.

1. Using standard twisted pair media, insert either end of the cable with an RJ-45 plug into the RJ-45 connector of the port. Note that, even though the connector is shielded, either unshielded or shielded cables and wiring may be used.
2. Connect the other end of the cable to the corresponding device
3. Use the LINK LED to ensure proper connectivity by noting that the LED will be illuminated when the unit is powered and proper connection is established
4. For Port #1, if the LINK LED is not illuminated, change to port 1X. If this does not help, ensure that the cable is connected properly and that the device on the other end is powered and is not defective.

### 3.2.2 Attaching to the MII port in the rear

MII Transceivers may be attached here. Since there are no industry standards for these, interoperability of user-selected MII transceivers that may be attached to a DS8016's MII port cannot be assured. Use of the MII port is not normally recommended accordingly.

### 3.2.3 100Mbps Collision Domain Diameter, Cable Distances and PDV Calculations

The 100Mbps Collision Domain Diameter is the length of the longest path between any two devices in a single collision domain. A collision domain is defined as a cluster of network devices which are connected by means of a repeater or repeaters such that no bridging devices are present between any two devices in the cluster. In order to install an IEEE 802.3u compliant Fast Ethernet network, the collision domain . . . regardless of the actual network topology . . . must be less than 512 BT (Bit Times). Bit Times are related to media type as shown in Table 3.2.3a.

**Table 3.2.3a: Worst case round-trip delay for Fast Ethernet media\***

Media Type	Round-trip delay in Bit Time per Meter (BT/m)
Fiber Optic	1.000
Shielded TP cable	1.112
Category 5 Cable	1.112
Category 3, 4 Cable	1.140

\*Worst case delays taken from IEEE Std 802.3u-1995, actual delays may be less for a particular cable. Contact your cable supplier for exact cable specifications.

Each Fast Ethernet device component also has an associated BT delay which depends on the physical signaling system employed. Table 3.2.3b shows each Fast Ethernet

device component and the associated BT delay. A “DTE” is an end node, such as a user station. Note that there is only one DTE pair associated with any device-to-device path.

**Table 3.2.3b: Worst case round-trip delay for Fast Ethernet device components\***

Component	Round-trip delay in Bit Times (BT)
2 TX DTEs	100
2 FX DTEs	100
1 FX and 1 TX DTE	100
1 T4 and 1 TX or FX DTE	127
Class I Repeater	140
Class II Repeater with any combination of TX and FX ports	92 **

\*Worst case delays taken from IEEE Std 802.3u -1995.

To determine whether a prospective network topology adheres to the collision domain diameter specification, the following formula should be applied to the worst case path through the network. The worst case path is the path between the two Fast Ethernet devices (DTEs) which have the longest round-trip time.

$$PDV = (\text{sum of cabling delays}) + (\text{sum of repeater delays}) + (\text{DTE pair delay}) + (\text{safety margin})$$

PDV is the Path Delay Value of the worst case path. For the network to adhere to IEEE standard, this value must be less than 512 BT. The safety margin is specified in BT and may be a value between 0 and 5. This margin can be used to accommodate unexpected delays such as extra long patch cable. A safety margin of about 2 to 4 BT is recommended.

A typical example of a PDV calculation is shown below, and is illustrated in Figure 3.2.3a. Here, an integrator wishes to cascade the 100Mbps collision domains of two Magnum DS8016 Hubs (each having a PDV of 80 BT) for use with standard 100m Category 5 user cable segments (i.e. from computer to hub) and needs to know how long the inter-repeater Category 5 cable segment, used to cascade the hubs, can be. The variable “X” represents the unknown maximum cascade cable delay.

$$\begin{aligned}
 PDV &= X + ((111 + 111) + (80 + 80) + (100) + 2) \text{ BT} < 512 \text{ BT} \\
 512 &> (X + 486) \text{ BT} \\
 X &< (512 - 486) \text{ BT}, X < 28 \text{ BT} \\
 \text{Twisted Pair cable length, TL} &< (28 \text{ BT}) / (1.112 \text{ m/BT}) \\
 TL &< 25 \text{ meters} \\
 \Rightarrow & 25 \text{ m maximum total length for Category 5 inter-repeater segment,}
 \end{aligned}$$

where 111 is the BT delay for 100m of Category 5 cable (1.112 BT/m\* 100m), 80 is the BT delay for each Magnum DS8016 , 100 is the BT delay for the TX DTE pair, and a safety margin of 2 was used.

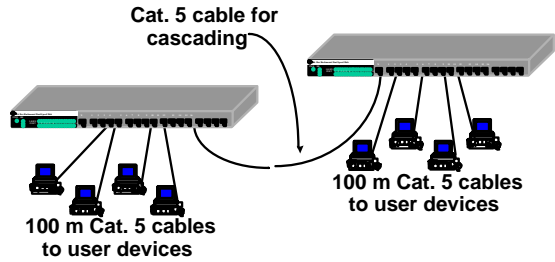

Figure

re 3.2.3a: Two cascaded Magnum DS8016 hubs

The resulting value tells us that a Category 5 cable with a length of up to 25 meters may be used to cascade the Magnum DS8016 s. Note that this inter-repeater cable length may be increased by shortening the lengths of the 100m hub-to-user cable segments.

It is also possible to cascade a group of up to nine Magnum DS8016 s (serving up to 56 users with full-length 100m cables to each) by using short inter-repeater cable segments. The following is an example of how to calculate the maximum allowable cascade cable segment length. An illustration of this example is shown in Figure 3.2.3b, where the hub-to-user cable lengths are up to 75 meters for Cat 5 twisted pair. The variable “X”, the maximum hub-to-hub cable delay, is calculated as follows:

$$PDV = X + ((100) + (80 + 80 + 80) + (83 + 83) + 2 ) BT < 512 BT$$

$$512 > (X + 508) BT, \quad X < 4 BT$$

$$\text{Twisted pair user cable length, TL} < (4 BT) / (1.112 \text{ m/BT})$$

$$TL < 3.6 \text{ meters for two hub-to-hub cascading cables}$$

$$\Rightarrow 2 \text{ meters (6 ft.) length max. for each of the cascade segments,}$$

In the above example, 75 is the BT delay for 70m of Category 5 cable (1.112 BT/m), 80 is the bit time delay for each Magnum DS8016 front-to-front ports, 100 is the BT delay for the TX DTE pair in the user stations, and 2 BT is the safety margin applied.

Figure 3.2.3b: Multiple cascaded Magnum DS8016 hubs

Note that the cascading of multiple Magnum DS8016 hubs is a capability beyond what

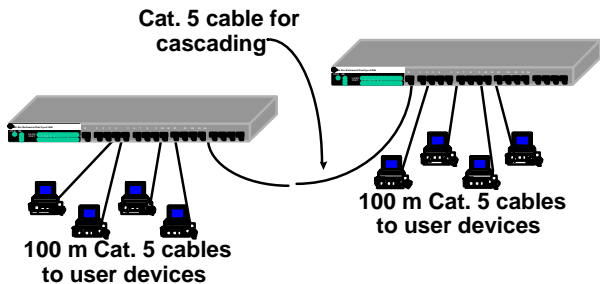

industry standards normally permit, and is different from what competitive 100Mbps Class II hub products normally allow. This additional cascading level and cable length is due to the relatively shorter bit time (80 BT actually measured, for front-port-to-port) delay of the Magnum DS8016 vs. the industry standard delay of 92 BT for Class II repeaters. The installation flexibility and network growth potential is accordingly better with Magnum DS8016 s than with hubs that merely meet the standard.

Table 3.2.3c shows maximum cable lengths for common network configurations using industry standard repeater PDV numbers. Calculations such as above should be performed using measured PDV data supplied by the equipment manufacturer in important installations.

**Table 3.2.3c: Maximum segment lengths for common network configurations**

Number of Hubs	Repeater Hop Count	Max. User Segment Lengths (m)	Max. Inter-Repeater (Cascade) Length (m)	Notes
1	1	100.0	n.a.	All ports TX
2	2	100.0	5.0	All ports TX
2	2	92.0	20.0	All ports TX
3+	3	60.0	1.0	All ports TX

Instructions for connecting the Magnum DS8016 Dual-Speed Hubs to the various Fast Ethernet media are given in the following sections.

### 3.2.4 Connections to NICs which support Auto-Negotiation

The Magnum DS8016 Dual-Speed Hub will function properly with NICs (Network Interface Cards) which support Auto-Negotiation. The Magnum DS8016 will establish link with any NIC which can send and receive the Fast Link Pulse (FLP) coding for the 100BASE-TX signaling system. When connecting a NIC to the DS8016, it may be necessary to reload the NIC drivers on the user device if the NIC has been communicating with a protocol other than 100BASE-TX (such as 10BASE-T). When 100Mb operation is agreed and in use, the 100Mb LINK/ACT LED is illuminated, steady ON if no traffic or blinking when there is traffic.

### 3.3 Powering the Magnum DS8016

Magnum DS8016 Dual-Speed Hubs incorporate an internal universal power supply, and have a recessed male IEC connector for the AC power cord in the rear. A six-foot 115

VAC 60Hz power cord is supplied with each unit shipped within the United States and Canada.

Each Magnum DS8016's auto-ranging power supply supports installation environments where the AC voltage is from 90 to 260 volts with an input frequency between 47 and 63 Hz, and consumes a maximum of 27 watts. In order to power the unit up or down, simply change the setting of the rear-mounted manual "On-Off" switch when there is incoming power.

## **4.0      OPERATION**

This chapter describes the function and operation of the Magnum DS8016 hubs.

### **4.1      Dual-Speed and Domain-Switched Functionality**

The Magnum DS8016-A handles the two different traffic domains separately (unless it is stacked with a DS8016-B), and the DS8016-E has only the 100Mb domain. Alternatively, the domain-switched DS8016-B provides switched (bridged) connectivity between the Ethernet (10Mb/s) and Fast Ethernet (100Mb/s) domains. It joins the two network domains for unified operation, and filters/ forwards packets in both directions to maximize bandwidth utilization and performance. Magnum DS8016s are hardware plug-and-play devices. There is no software set-up to be done at installation or for maintenance. The functions of the DS8016s are described in this manual.

Each time a packet is received on one domain of the bridge module, the decision is taken to either to filter or forward the packet. Errored packets are always filtered. For good packets, the filter and forward decisions are made based on the destination address contained in each packet. If the destination address is on the same domain from which the packet originated, then it is filtered and not forwarded to the other domain. If the destination address is not found to be a match in the address table for the originating domain, then it is forwarded to the other domain. If it is a new node address coming in which the switch did not previously know about, it "learns" the new address and puts it in the correct port address table. See "Address Learning" for more details.

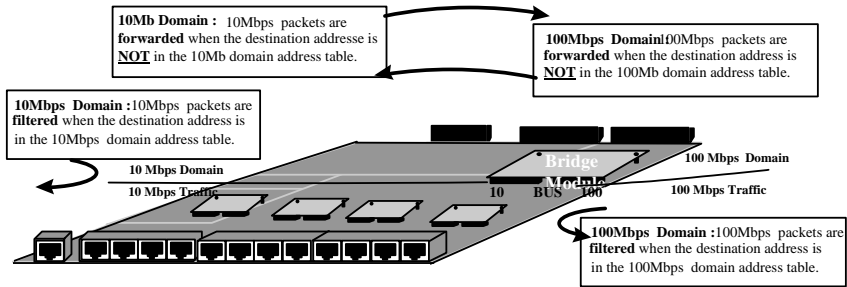

**Fig 4.1 Filtering vs Forwarding in Domain Switched Hubs with an internal Bridge or Switch**

### 1. Filter / Forward logic for both 10Mb and 100Mb domains

<u>Packet Source</u>	<u>Source Address</u>	<u>Destination Address</u>	<u>Address Table Maintenance</u>	<u>Filter/Forward Action</u>
10 Mb	Not in table	Not in table	Add source to table	Forward
10 Mb	Not in table	In table	Add source to table	Filter
10 Mb	In table	Not in table	None	Forward
10 Mb	In table	In table	None	Filter
100 Mb	Not in table	Not in table	Add source to table	Forward
100 Mb	Not in table	In table	Add source to table	Filter
100 Mb	In table	Not in table	None	Forward
100 Mb	In table	In table	None	Filter

**Table 4.1: DS8016-B Domain-Switched Hub Functionality**

### 2. Address Learning (Address Table Maintenance)

The Magnum DS8016-B bridge module is a state machine design which has a total address table capacity of 8K addresses. With a large address table, a Magnum DS8016 can serve the needs of a medium-sized to large network. Table 4.1 shows what filter / forward action the Magnum DS8016-B will take in each packet-processing situation, and when a new node address will be added to the internal Address Table. When a new node-address packet comes into a port for the first time, then the new source address is “learned” at the same time that the packet is forwarded. After learning, subsequent packets from the same node address are routinely processed. The address tables are flushed periodically to update the network status and to purge any inactive stations from the tables of both domains.

### 3. Throughput Increase

By selectively forwarding packets from each domain to the other domain based on its switching (bridging) logic, the domain-switched Magnum DS8016-B increases the available bandwidth for the users on both sides of the network. As shown in Figure 4.1, it keeps the local traffic on each side contained, preventing unnecessary packets and bad packets from traveling to the other domain and using up bandwidth needlessly there. This results in more available network bandwidth on both sides and a throughput increase on for all users on both domains.

#### **4.    Software Transparency**

The Magnum DS8016-A Dual-Speed Hubs, the DS8016-E 100Mb-only Hubs and the DS8016-B Dual-Speed Domain-Switched Hubs need no software set-up and are transparent to system and application software, including network management software.



## 4.2 Auto-negotiation and speed-sensing

All sixteen RJ-45 ports independently support auto-negotiation for shared 10BASE-T and 100BASE-TX modes. When the '100' LED is flashing, it means that the corresponding port is sending out auto-negotiation pulses on that port. When a LINK connection is made, the other device should respond and both sides should agree to the speed being signaled. The device connected, depending on what it is, will either signal that it is capable of 10Mb or 100Mb speeds. Silence means the port defaults to 10Mb.

When the '100' LED is steady ON, the port has auto-negotiated for 100Mb operation and is processing packets at 100Mb/s. When it is OFF, it is at 10Mb/s. If a DS8016 port is connected to a non-negotiating device, it will default to 10Mb speed. Since Magnum DS8016s are hubs, they always operate in the shared or half-duplex mode on all ports.

General information -

**Auto-negotiation per-port for dual-speed hubs occurs when:**

the devices at both ends of the cable are capable of operation at either 10Mb or 100Mb speed, and can send/receive auto-negotiation pulses, and . . .

- when the second of the two connected devices is powered up\*, i.e., when LINK is established for a port, or
- when LINK is re-established on a port after being lost temporarily.

- NOTE – some NIC cards only auto-negotiate when the computer system that they are in is powered up. These are exceptions to the “negotiate at LINK – enabled” rule above, but may be occasionally encountered.

### 4.3      LED's

- PWR**      : Illuminates GREEN to indicate AC power is applied to the unit.
  
- COL**      : Red LED Blinks intermittently when a collision occurs.
  
- BR**      : Bridge Module Indicator, On when 10/100 bridge module is installed (Model DS8016-B), Off when no bridge module is inside (DS8016A)
  
- 100/Auto** : Speed LED per port. Steady On when speed is 100Mbps , Off when speed is 10Mb, flashing when auto-negotiating or when not connected (no LINK)
  
- LK/RX**   : Activity LED per port. Steady On when twisted-pair link is operational. Activity, flashing when port is receiving data.

### 4.4      Up-link Port 1X

Magnum DS8016s each have one Up-link port, port # 1X, which can be used when port #1 is not connected. The Up-link port allows repeater-to-repeater connections without a special cross-over cable. It works the same for 10Mb or 100Mb connections.

Use port “1” (or ports 2 thru 16) for straight-through twisted pair cabling from the DS8016 port to a user device, or the “1X” port for cross-over or up-link segment connections from the first DS8016 port to a repeater or hub or switch. Verify proper port connection by noting the port's LINK/RX status, which is illuminated when a proper link is made and blinking when there is activity.

**Note: Port # 1 and Port # 1X, provided for RJ45 connections, are logically one port. Only one of these ports, either # 1 or # 1X may be used at one time simultaneously.**

## 5.0 TROUBLESHOOTING

All Magnum Ethernet products are designed to provide reliability and consistently high performance in all network environments. The installation of Magnum DS8016 10/100 Dual Speed Stackable Hubs is a straightforward procedure (see INSTALLATION, Section 2.6); the operation is also straightforward and is discussed in Section 4.

Should problems develop during installation or operation, this section is intended to help locate, identify and correct these types of problems. Please follow the suggestions listed below prior to contacting your supplier. However, if you are unsure of the procedures described in this section or if the Magnum DS8016 10/100 Dual Speed Stackable Hub is not performing as expected, do not attempt to repair the unit; instead contact your supplier for assistance or contact GarrettCom Customer Support.

### 5.1 Before Calling for Assistance

1. If difficulty is encountered when installing or operating the unit, refer back to the installation Section of the applicable chapter of this manual. Also check to make sure that the various components of the network are interoperable.
2. Check the cables and connectors to ensure that they have been properly connected and the cables/wires have not been crimped or in some way impaired during installation. (About 90% of network downtime can be attributed to wiring and connector problems.)
3. Make sure that an AC power cord is properly attached to each Magnum DS8016 10/100 Dual Speed Stackable Hubs unit. Be certain that each AC power cord is plugged into a functioning electrical outlet. Use the PWR LEDs to verify each unit is receiving power.
4. If the problem is isolated to a network device other than the Magnum DS8016 10/100 Dual Speed Stackable Hub product, it is recommended that the problem device is replaced with a known good device. Verify whether or not the problem is corrected. If not, go to Step 5 below. If the problem is corrected, the Magnum DS8016 10/100 Dual Speed Stackable Hubs and its associated cables are functioning properly.
5. If the problem continues after completing Step 4 above, contact your supplier of the Magnum DS8016 10/100 Dual Speed Stackable Hubs unit or if unknown, contact GarrettCom, Inc. by fax, phone or email (*support@garrettcom.com*) for assistance.

## 5.2 When Calling for Assistance

Please be prepared to provide the following information.

1. A complete description of the problem, including the following points:
  - a. The nature and duration of the problem;
  - b. Situations when the problem occurs;
  - c. The components involved in the problem;
  - d. Any particular application that, when used, appears to create the problem;
2. An accurate list of GarrettCom product model(s) involved, with serial number(s). Include the date(s) that you purchased the products from your supplier.
3. It is useful to include other network equipment models and related hardware, including personal computers, workstations, terminals and printers; plus, the various network media types being used.
4. A record of changes that have been made to your network configuration prior to the occurrence of the problem. Any changes to system administration procedures should all be noted in this record.

## 5.3 Return Material Authorization (RMA) Procedure

All returns for repair must be accompanied by a Return Material Authorization (RMA) number. To obtain an RMA number, please use this URL - [https://rma.garrettcom.com/rma/rma\\_request\\_noaccount.php](https://rma.garrettcom.com/rma/rma_request_noaccount.php) to fill out the form. Please have the following information readily available:

Name and phone number of your contact person.  
Name of your company / institution  
Your shipping address  
Product name  
Serial Number (or Invoice Number)  
Packing List Number (or Sales Order Number)  
Date of installation  
Failure symptoms, including a full description of the problem.

GarrettCom will carefully test and evaluate all returned products, will repair products that are under warranty at no charge, and will return the warranty-repaired units to the sender with shipping charges prepaid (see Warranty Information, Appendix A, for complete details). However, if the problem or condition causing the return cannot be duplicated by GarrettCom, the unit will be returned as:

**No Problem Found.**

GarrettCom reserves the right to charge for the testing of non-defective units under warranty. Testing and repair of product that is not under warranty will result in a customer (user) charge.

## 5.4 Shipping and Packaging Information

Should you need to ship the unit back to GarrettCom, please follow these instructions:

1. Package the unit carefully. It is recommended that you use the original container if available. Units should be wrapped in a "bubble-wrap" plastic sheet or bag for shipping protection. ( You may retain all connectors and this Installation Guide.)

**CAUTION: Do not pack the unit in Styrofoam "popcorn" type packing material. This material may cause electro-static shock damage to the unit.**

2. Clearly mark the Return Material Authorization (RMA) number on the outside of the shipping container.
3. GarrettCom is not responsible for your return shipping charges.
4. Ship the package to:

**GarrettCom, Inc.**  
**47823 Westinghouse Dr.**  
**Fremont, CA 94539-7437**  
**Attn.: Customer Service**

## **APPENDIX A: WARRANTY INFORMATION**

GarrettCom, Inc. warrants its products to be free from defects in materials and workmanship for a period of three (3) years from the date of shipment by GarrettCom.

During this warranty period, GarrettCom will repair or, at its option, replace components in the products that prove to be defective at no charge other than shipping and handling, provided that the product is returned pre-paid to GarrettCom.

This warranty will not be effective if, in the opinion of GarrettCom, the product has been damaged by misuse, misapplication, or as a result of service or modification other than by GarrettCom.

GarrettCom reserves the right to make a charge for handling and inspecting any product returned for warranty repair which turns out not to be faulty.

Please complete the warranty card as this acts as a product registration, and mail it to GarrettCom within two weeks of your purchase.

## APPENDIX B : Optional 48V DC Power Supply, Addendum

### B1.0 SPECIFICATIONS - FOR DUAL-SPEED DS8016 HUBS

#### Power Supply (Internal 48 VDC Option)

DC Power Connector: 3 terminals: “-“, “GND”, “+”

Input Voltage: 36 - 70 VDC (auto-ranging)

Power Consumption: Model DS8016: 25 watt typical, 40 watts max.

**With the exception of the power supply, all specifications and functions of Magnum DS80016-48VDC models are identical to those listed in Section 1.**

### B2.0 48V DC SOURCE OPTION, THEORY OF OPERATION

The 48VDC power option is designed using diodes inside on each DC power input line behind the two external power connection terminals, so that the power from an external source can only flow into the hub. This allows the hub to operate only whenever DC power is correctly applied to the two inputs. It protects the hub from incorrect DC input connections. An incorrect polarity connection, for example, will neither effect the hub, nor its power supply internally, nor will it blow the fuse in the internal power supply.

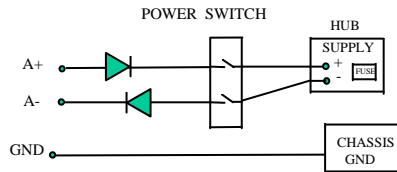

The power switch (included on premium-priced NEBS-certified units only) is used for powering the hub on and off when it is placed into or taken out of service.

### B3.0 APPLICATIONS

Magnum DS8016 Dual-Speed Hubs are easily installed in a variety of applications where 48 VDC power is used as the primary power source. The 48VDC power configuration provides an Ethernet networking solution utilizing a special power supply in hubs with a proven track record.

The solution is particularly useful in the telecommunication industry, where it is common for facilities to operate on 48VDC power. Such companies include regular and wireless telephone service providers, Internet Service Providers (ISPs) and other communication companies. In addition, many high availability equipment services, such as broadcasters, publishers, newspaper operations, brokerage firms and other facilities often use a battery backup system to maintain operations in the event of a power failure. It is also frequently used for computer system backup, management and operations monitoring equipment.

## B4.0 INSTALLATION

This section describes the installation of the 48 VDC power source leads to the 48 VDC power terminal block on the Magnum DS8016s. (see figure below).

**Figure A4.1: 48 VDC Terminal Block on Magnum DS8016-48VDC**

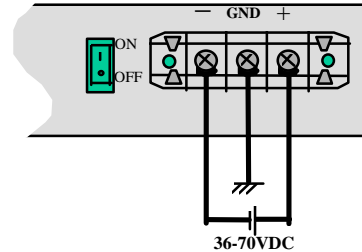

The 48 VDC terminal block on the Magnum DS8016s is located on the rear of the unit and is equipped with three (3) screw-down lead posts.

The leads are identified as negative (-), positive (+), and chassis ground (GND). The actual connection procedure is very straightforward. Simply connect the leads to the Magnum unit, beginning with ground. Ensure that each lead is securely tightened.

On the premium-priced NEBS-compliant Magnum DS8016-48V models, an ON-OFF switch is included, located in the rear at the power input. This can be used in conjunction with power connections, and as a RESET for the hub's electronics.

### B4.1 UL Requirements

1. *Minimum 14 AWG cable for connection to a Centralized DC power source.*
2. *Fastening torque of the lugs on the terminal block: 9 inch pound max.*
3. *Centralized DC Power Source cable securement, use at least four cable ties to secure the cable to the rack at least 4 inches apart with the first one located within 6 inches of the terminal block.*

## B5.0 OPERATION

Operation of the Magnum DS8016s with the optional 48VDC power supply is identical to that of the standard AC-powered models.

## B6.0 TROUBLESHOOTING

Please refer to Section 5.0 for troubleshooting

## APPENDIX C: Optional 48V Dual-Source DC Power, Addendum

### C1.0 SPECIFICATIONS - FOR MAGNUM DS8016 DUAL-SPEED HUBS

#### Power Supply (Internal, 48VDC Dual-Source model)

DC Power Connector: First Source: “A+”, “A-“, 2nd Source “B-“, “B+”

GND: Terminal for “earth” or ground wire connection to the hub chassis

Input: Two separate sources, each at 36 - 70 VDC (auto-ranging)

Power Consumption: Model DS8016: 25 watt typical, 40 watts max.

With the exception of the dual DC input power connections and the power supply, all specifications and configuration options for the Magnum DS8016-48VDC with this Dual-Source option are identical to those listed in the *Magnum DS8016 Dual-Speed Hubs Installation and User Guide*, including Appendix A “Optional 48VDC Power”

### C2.0 MAGNUM DS8016 (48VDC DUAL-SOURCE POWER OPTION)

The hub models with the internal 48VDC Dual-Source power supply are designed for installations where a battery plant is the power source, and where two separate power sources are utilized in order to increase operational uptime and to simplify maintenance.

The functionality of the Magnum DS8016-48VDC Dual-Source Option hubs are identical to the standard AC-powered models. All Port Module, SNMP and stacking options are available for configuration with Dual-Source Option units. Refer to the main sections of this *Installation and User Guide* for a detailed description of the Magnum DS8016 Hubs.

### C3.0 DUAL-SOURCE OPTION, THEORY OF OPERATION

The Dual-Source DC power option is designed using diodes inside of the hub on each DC power input line. A diode is placed in each of the four input lines (behind the four external power connection terminals) so that power from an external source can only flow into the hub. This allows the hub to operate whenever DC power is correctly applied to either or both of the two inputs.

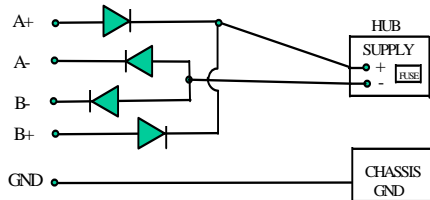



#### C4.0 FEATURES AND BENEFITS OF THE DUAL-SOURCE DESIGN

- a) *The hub can receive power from either input, “A” or “B”. The hub will normally draw its power from the DC source with the highest voltage (in the 36-70V range) at a given time.*
- b) *The hub will not allow power to flow from a higher voltage input to a lower voltage input, i.e. the two DC power sources are not mixed together by the hub.*
- c) *When one correct DC input is present, the hub will receive power if the other DC input is absent, or even if it is connected with reverse polarity or shorted or grounded.*
- d) *Reverse polarity connections, if they should accidentally occur on either input, will not damage the hub or power supply internally (nor will it blow the fuse in the internal power supply) because of the blocking action of the diodes. This is true even if one input connection is reversed while the hub is operating from the other source.*
- e) *The hub will not receive power (and will not work) when both inputs are simultaneously absent or are both incorrectly connected.*
- f) ***This product shall be provided with a Listed fuse or circuit breaker, rated 5 A, in the supply circuit when connected to a 48 V centralized dc source.***

#### C5.0 INSTALLATION

This section describes the proper connection of the 48VDC dual source leads to the 48VDC power terminal block on the Magnum DS8016 hub (shown in Figure C4.0).

The 48VDC terminal block on the Magnum DS8016 is located on the right rear of the unit and is equipped with five (5) screw-down lead posts. The primary terminals are identified as positive (A+), negative (A-), and the secondary power terminals as negative (B-), positive (B+), and the chassis “earth” or ground (GND).

**Figure B5.0: 48V DC Dual-Source, wiring connections to the External Terminal Block on a Magnum DS8016 48VDC with Dual-Source option**

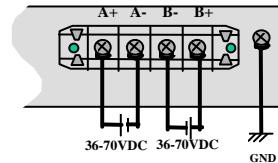

The connection procedure is straightforward. Simply connect the DC leads to the Magnum

hub power terminals, positive (+) and negative (-) screws. The use of Ground (GND) is optional, as this terminal connects to the hub chassis. Ensure that each lead is securely tightened.

##### C5.1UL Requirements

The following must be adhered to in order to conform to UL requirements:

1. *Minimum 14 AWG cable for connection to a Centralized DC power source.*
2. *Fastening torque of the lugs on the terminal block: 9 inch pound max.*
3. *Centralized DC Power Source cable securement, use at least four cable ties to secure the cable to the rack at least 4 inches apart with the first one located within 6 inches of the terminal block.*

#### C6.0 OPERATION

Operation of the Dual-Source Magnum DS8016-48VDC hub models is identical to that of the standard models. Please refer to the applicable sections of the “Installation and User Guide” for more information on the basic hubs.