

Preface

Thank you for choosing DELTA's high-performance VFD-M Series. The VFD-M Series is manufactured with high-quality components and materials and incorporates the latest microprocessor technology available.

Getting Started

This quick start will be helpful in the installation and parameter setting of the AC motor drives. To guarantee safe operation of the equipment, read the following safety guidelines before connecting power to the AC motor drives. For detail information, refer to the VFD-M User Manual on the CD supplied with the drive.

DANGER!

1. AC input power must be disconnected before any wiring to the AC motor drive is made.
2. A charge may still remain in the DC-link capacitors with hazardous voltages, even if the power has been turned off. To prevent personal injury, please ensure that power has turned off before opening the AC motor drive and wait ten minutes for the capacitors to discharge to safe voltage levels.
3. Never reassemble internal components or wiring.
4. The AC motor drive may be destroyed beyond repair if incorrect cables are connected to the input/output terminals. Never connect the AC motor drive output terminals U/T1, V/T2, and W/T3 directly to the AC mains circuit power supply.
5. Ground the VFD-M using the ground terminal. The grounding method must comply with the laws of the country where the AC motor drive is to be installed. Refer to the Basic Wiring Diagram.
6. VFD-M series is used only to control variable speed of 3-phase induction motors, NOT for 1-phase motors or other purpose.
7. VFD-M series shall NOT be used for life support equipment or any life safety situation.

WARNING!

1. DO NOT use Hi-pot test for internal components. The semi-conductor used in AC motor drive easily damage by high-pressure.
2. There are highly sensitive MOS components on the printed circuit boards. These components are especially sensitive to static electricity. To prevent damage to these components, do not touch these components or the circuit boards with metal objects or your bare hands.
3. Only quality person is allowed to install, wire and maintain AC motor drive.

CAUTION!

1. Some parameters settings can cause the motor to run immediately after applying power.
2. DO NOT install the AC motor drive in a place subjected to high temperature, direct sunlight, high humidity, excessive vibration, corrosive gases or liquids, or airborne dust or metallic particles.
3. Only use AC motor drives within specification. Failure to comply may result in fire, explosion or electric shock.
4. To prevent personal injury, please keep children and unqualified people away from the equipment.
5. When the motor cable between AC motor drive and motor is too long, the layer insulation of the motor may be damaged. Please use a frequency inverter duty motor or add an AC output reactor to prevent damage to the motor. Refer to appendix B Reactor for details.
6. The rated voltage for AC motor drive must be $\leq 240\text{V}$ for 230V models ($\leq 120\text{V}$ for 115V models, $\leq 480\text{V}$ for 460V models, $\leq 600\text{V}$ for 575V models) and the mains supply current capacity must be $\leq 5000\text{A RMS}$ ($\leq 10000\text{A RMS}$ for the $\geq 40\text{hp}$ (30kW) models).



Specifications



Voltage Class		115V Class		
Model Number VFD-XXXM	002	004	007	
Max. Applicable Motor Output (kW)	0.2	0.4	0.75	
Max. Applicable Motor Output (hp)	0.25	0.5	1.0	
Output Rating	Rated Output Capacity (kVA)	0.6	1.0	1.6
	Rated Output Current (A)	1.6	2.5	4.2
	Maximum Output Voltage (V)	3-Phase proportion to twice the input voltage		
	Output Frequency (Hz)	0.1~400 Hz		
		Carrier Frequency (kHz)		
		1-15		
Input Rating	Rated Input Current (A)	Single phase		
		6	9	16
	Rated Voltage, Frequency	Single phase, 100-120 VAC, 50/60Hz		
	Voltage Tolerance	+10% (90-132VAC)		
		Frequency Tolerance		
		± 5% (47~63Hz)		
Cooling Method		Fan Cooled		
Weight (kg)		1.5	1.5	1.5

Voltage Class		230V Class					
Model Number VFD-XXXM	004	007	015	022	037	055	
Max. Applicable Motor Output (kW)	0.4	0.75	1.5	2.2	3.7	5.5	
Max. Applicable Motor Output (hp)	0.5	1.0	2.0	3.0	5.0	7.5	
Output Rating	Rated Output Capacity (kVA)	1.0	1.9	2.7	3.8	6.5	9.5
	Rated Output Current (A)	2.5	5.0	7.0	10	17	25
	Maximum Output Voltage (V)	3-Phase proportional to input voltage					
	Output Frequency (Hz)	0.1~400 Hz					
		Carrier Frequency (kHz)					
		1-15					
Input Rating	Rated Input Current (A)	Single/3-phase			3-phase		
		6.3/2.9	11.5/7.6	15.7/8.8	27/12.5	19.6	28
	Input Current for 1-phase Models when Using 3-phase Power	3.2	6.3	9.0	12.5	--	--
	Rated Voltage, Frequency	Single/3-phase 200-240 VAC, 50/60Hz			3-phase 200-240VAC, 50/60Hz		
	Voltage Tolerance	+10% (180~264 VAC)					
		Frequency Tolerance					
		± 5% (47~63 Hz)					
Cooling Method		Fan Cooled					
Weight (kg)		2.2/1.5	2.2/1.5	2.2/1.5	3.2/2.2	3.2	3.2

Voltage Class		460V Class					
Model Number VFD-XXXM	007	015	022	037	055	075	
Max. Applicable Motor Output (kW)	0.75	1.5	2.2	3.7	5.5	7.5	
Max. Applicable Motor Output (hp)	1.0	2.0	3.0	5.0	7.5	10	
Output Rating	Rated Output Capacity (kVA)	2.3	3.1	3.8	6.2	9.9	13.7
	Rated Output Current (A)	3.0	4.0	5.0	8.2	13	18
	Maximum Output Voltage (V)	3-phase Proportional to Input Voltage					
	Output Frequency (Hz)	0.1~400 Hz					
		Carrier Frequency (kHz)					
		1-15					
Input Rating	Rated Input Current (A)	3-phase					
		4.2	5.7	6.0	8.5	14	23
	Rated Voltage, Frequency	3-phase 380~480 VAC, 50/60Hz					
	Voltage Tolerance	+10% (342~528 VAC)					
		Frequency Tolerance					
		± 5% (47~63 Hz)					
Cooling Method		Fan Cooled					
Weight (kg)		1.5	1.5	2.0	3.2	3.2	3.3

Voltage Class		575V Class					
Model Number VFD-XXXM		007	015	022	037	055	075
Max. Applicable Motor Output (kW)		0.75	1.5	2.2	3.7	5.5	7.5
Max. Applicable Motor Output (hp)		1.0	2.0	3.0	5.0	7.5	10
Output Rating	Rated Output Capacity (kVA)	1.7	3.0	4.2	6.6	9.9	12.2
	Rated Output Current (A)	1.7	3.0	4.2	6.6	9.9	12.2
	Maximum Output Voltage (V)	3-phase Proportional to Input Voltage					
	Output Frequency (Hz)	0.1~400 Hz					
Input Rating	Carrier Frequency (kHz)	1-10					
	Rated Input Current (A)	3-phase					
		2.4	4.2	5.9	7.0	10.5	12.9
	Rated Voltage, Frequency	3-phase 500-600 VAC, 50/60Hz					
Voltage Tolerance	-15%~+10% (425~660 VAC)						
Frequency Tolerance	± 5% (47~63 Hz)						
Cooling Method	Fan Cooled						
Weight (kg)		1.5	1.5	2.0	3.2	3.2	3.3

General Specifications			
Control Characteristics	Control System	SPWM (Sinusoidal Pulse Width Modulation) control (V/F or sensorless vector control)	
	Freq. Setting Resolution	0.1Hz	
	Output Frequency Resolution	0.1Hz	
	Torque Characteristics	Including the auto-torque, auto-slip compensation; starting torque can be 150% at 5.0Hz	
	Overload Endurance	150% of rated current for 1 minute	
	Skip Frequency	Three zones, settings range 0.1-400Hz	
	Accel/Decel Time	0.1 to 600 seconds (4 Independent settings for Accel/Decel Time)	
	Stall Prevention Level Frequency Setting	20 to 200%, Setting of Rated Current	
	DC Injection Braking	Operation frequency 0-60Hz, output 0-100% rated current Start time 0-5 seconds, stop time 0-25 seconds	
	Braking Torque	Approx. 20% (up to 125% possible with option brake resistor or brake unit externally mounted, 1-15HP braking transistor built-in)	
V/F Pattern	Adjustable V/F pattern		
Operating Characteristics	Frequency Setting	Keypad	Setting by  
		External Signal	Potentiometer-5K Ω /0.5V, 0 to +10VDC, 4 to 20mA RS-485 interface; Multi-Function Inputs 0 to 5 (7 steps, Jog, up/down)
	Operation Setting	Keypad	Set by RUN, STOP
		External Signal	M0 to M5 can be combined to offer various modes of operation, RS-485 serial interface (MODBUS).
	Multi-Function Input Signal	Multi-step selection 0 to 7, Jog, accel/decel inhibit, first to forth accel/decel switches, counter, PLC operation, external Base Block (NC, NO), auxiliary motor control is invalid, selections, driver reset, UP/DOWN key settings, sink/source selection	
	Multi-Function Output Indication	AC drive operating, frequency attained, non-zero, base block, fault indication, local/remote indication, PLC operation indication, auxiliary motor output, driver is ready, overheat alarm, emergency stop	
Alarm Output Contact	Analog frequency/current signal output.		
Operation Functions	1 Form C contact or open collector output		
	AVR, S-Curve, over-voltage, over-current stall prevention, fault records, adjustable carrier frequency, DC braking, momentary power loss restart, auto tuning, frequency limits, parameter Lock/Reset, vector control, counter, PID Control, PLC, MODBUS communication, reverse Inhibition, abnormal reset, abnormal re-start, digital frequency output, sleep/revival function, 1st/2nd frequency source selections		

General Specifications		
Protection Functions	Self-testing, over voltage, over current, under voltage, overload, overheating, external fault, electronic thermal, ground fault.	
Display Keypads	6-key, 4-digit, 7-segment LED, 4 status LEDs, master frequency, output frequency, output current, custom units, parameter values for setup, review and faults, RUN, STOP, RESET, FWD/REV	
Built-in Brake Chopper	Built-in for all models	
Environmental Conditions	Protection Level	IP20
	Pollution Degree	2
	Installation Location	Altitude 1,000 m or lower, keep from corrosive gasses, liquid and dust
	Ambient Temperature	-10°C to 40°C (-10°C to 50°C without blind plate) Non-Condensing and not frozen
	Storage/Transportation Temperature	-20°C to 60°C
	Ambient Humidity	Below 90% RH (non-condensing)
Vibration	9.80665m/s ² (1G) less than 20Hz, 5.88m/s ² (0.6G) at 20 to 50Hz	
Approvals	  	

Note: Do not attempt to connect a single-phase power source to a three-phase models drive. However it is acceptable to connect two wires of a three-phase power source to a single-phase drive.

Basic Wiring Diagram

Users must connect wiring according to the following circuit diagram shown below.

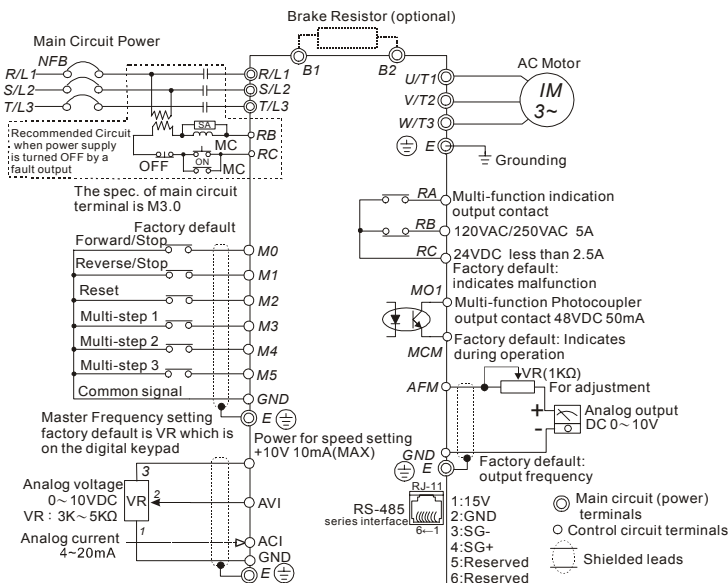

NOTE: Do not plug a Modem or telephone line to the RS-485 communication port, permanent damage may result. Terminal 1& 2 are the power sources for the optional copy keypad and should not be used while using RS-485 communication.

* If it is single phase model, please select any of the two input power terminals in main circuit power.

* Single phase model can be input 3-phase power.

Description of Digital Keypad

The digital keypad includes two parts: Display panel and keypad. The display panel provides the parameter display and shows the operation status of the AC drive and the keypad provides programming and control interface.

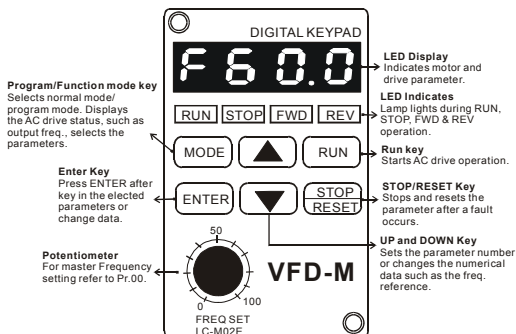

How to Operate the Digital Keypad LC-M02E

Selection mode



NOTE: In the selection mode, press **ENTER** to set the parameters.

To set parameters

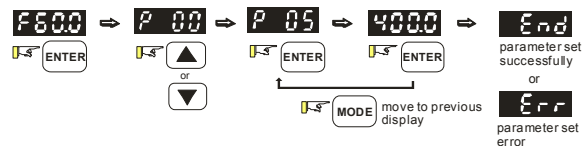

NOTE: In the parameter setting mode, you can press **MODE** to return to the selection mode.

To modify data



To set direction

(When operation source is digital keypad)

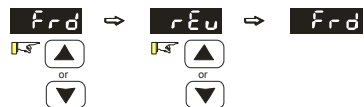

Power Terminals

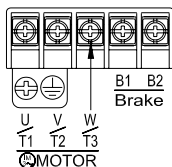
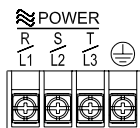

Model Name	Max. Current (input / output)	Wire Gauge AWG (mm ²)	Torque kgf-cm (in-lbf)	
VFD002M11A	6A/1.6A	12-14	14 (12)	
VFD004M11A	9A/2.5A	(3.3-2.1)		
VFD007M11A	16A/4.2A	12 (3.3)		
VFD004M21A/21B	6.3A/2.5A	12-14 (3.3-2.1)		
VFD004M23A	3.2A/2.5A			
VFD007M21A/21B	11.5A/5.0A			
VFD007M23A	6.3A/5.0A			
VFD015M21A/21B	15.7A/7.0A	12 (3.3)		
VFD015M23A	9.0A/7.0A	12-14 (3.3-2.1)		15 (13)
VFD022M21A	27A/10A	8 (8.4)		
VFD022M23B	15A/10A	8-12 (8.4-3.3)		
VFD037M23A	19.6A/17A	8-10 (8.4-5.3)		
VFD055M23A	28A/25A	8 (8.4)		
VFD007M43B	4.2A/3.0A	12-14 (3.3-2.1)	14 (12)	
VFD007M53A	2.4A/1.7A	12-14 (3.3-2.1)		
VFD015M43B	5.7A/4.0A	12-14 (3.3-2.1)		
VFD015M53A	4.2A/3.0A	12-14 (3.3-2.1)		
VFD022M43B	6.0A/5.0A	12-14 (3.3-2.1)		
VFD022M53A	5.9A/4.2A	12-14 (3.3-2.1)		
VFD037M43A	8.5A/8.2A	8-14 (8.4-2.1)	15 (13)	
VFD037M53A	7.0A/6.6A	8-14 (8.4-2.1)		
VFD055M43A	14A/13A	8-12 (8.4-3.3)		
VFD055M53A	10.5A/9.9A	8-12 (8.4-3.3)		
VFD075M43A	23A/18A	8-10 (8.4-5.3)		
VFD075M53A	12.9A/12.2A	8-12 (8.4-3.3)		

Wire Type: 75 °C Copper Only

Note: It needs to use the Recognized Ring Terminal to conduct a proper wiring.

Terminal Explanations

Terminal Symbol	Explanation of Terminal Function
R/L1, S/L2, T/L3	AC line input terminals (three phase)
U/T1, V/T2, W/T3	Motor connections
B1 – B2	Connections for brake resistor (optional)
	Earth Ground

Control Terminal Wiring (Factory Setting)

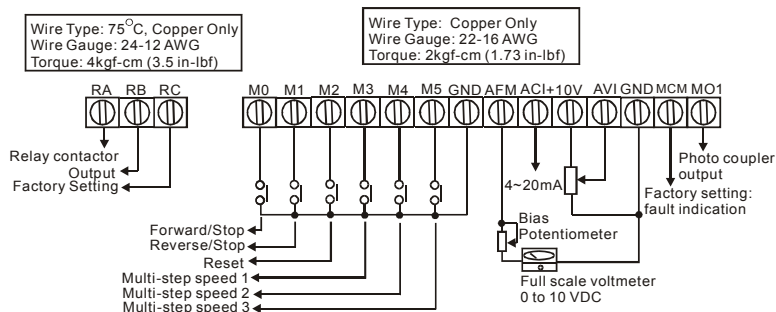

NPN Mode

NPN mode without external power

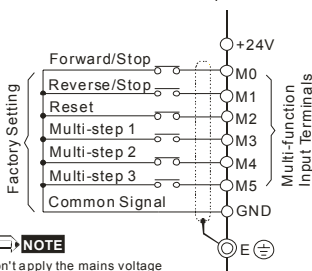

NOTE

Don't apply the mains voltage directly to above terminals.

NPN mode with external power

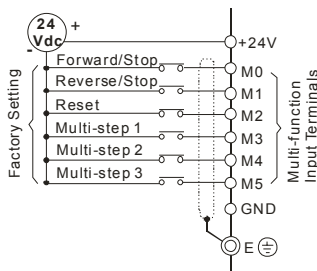

Terminal Symbol	Terminal Function	Factory Settings (NPN mode)
RA	Multi-Function Relay Output (N.O.) a	RA-RC Resistive Load 5A(N.O.)/3A(N.C.) 277Vac; 5A(N.O.)/3A(N.C.) 30Vdc Refer to P45 for programming.
RB	Multi-Function Relay Output (N.C.) b	RB-RC Resistive Load 5A(N.O.)/3A(N.C.) 277Vac; 5A(N.O.)/3A(N.C.) 30Vdc
RC	Multi-function Relay Common	5A(N.O.)/3A(N.C.) 277Vac; 5A(N.O.)/3A(N.C.) 30Vdc

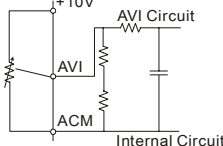
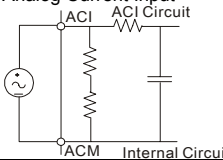
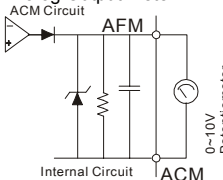
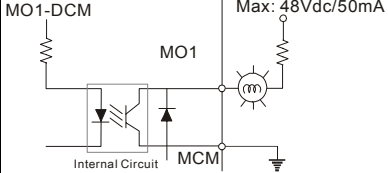
Terminal Symbol	Terminal Function	Factory Settings (NPN mode)
M0	Multi-function auxiliary input	M0~M5-GND Refer to P38~P42 for programming the multi-function inputs. ON: the activation current is 10 mA. OFF: leakage current tolerance is 10 μ A.
M1	Multi-function input 1	
M2	Multi-function input 2	
M3	Multi-function input 3	
M4	Multi-function input 4	
M5	Multi-function input 5	
GND	Common Signal	
+10V	+10 Vdc Output	+10V-GND It can supply +10 VDC power.
AVI	Analog Voltage Input 	Impedance: 20k Ω Resolution: 10 bits Range: 0~10Vdc = 0~Max.Output Frequency
ACI	Analog Current Input 	Impedance: 250 Ω Resolution: 10 bits Range: 4~20mA = 0~Max.Output Frequency
AFM	Analog Output Meter 	0 to 10V, 2mA Impedance: 100k Ω Output Current: 2mA max Resolution: 8 bits Range: 0 ~ 10Vdc
MO1	Multi-function Output Terminal (Photocoupler)	Maximum: 48Vdc, 50mA Refer to P45 for programming. 
MCM	Multi-function Output Common (Photocoupler)	Common for Multi-function Outputs

Note: Use twisted-shielded, twisted-pair or shielded-lead wires for the control signal wiring. It is recommended to run all signal wiring in a separate steel conduit. The shield wire should only be connected at the drive. Do not connect shield wire on both ends.

SUMMARY OF PARAMETER SETTINGS

↗: The parameter can be set during operation

Parameter	Explanation	Settings	Factory Setting	Customer
↗Pr.00	Source of Frequency Command	00: Master frequency determined by digital keypad (LC-M02E) 01: Master frequency determined by 0 to +10 V input on AVI terminal with jumpers 02: Master frequency determined by 4 to 20mA input on ACI terminal with jumpers 03: Master frequency determined by RS-485 Communication port 04: Master frequency determined by potentiometer on digital keypad	00	
↗Pr.01	Source of Operation command	00: Operation determined by digital keypad 01: Operation determined by external control terminals, keypad STOP is effective 02: Operation determined by external control terminals, keypad STOP is ineffective 03: Operation determined by RS-485 communication port, keypad STOP is effective 04: Operation determined by RS-485 communication port, keypad STOP is ineffective	00	
Pr.02	Stop Method	00: Ramp stop 01: Coast Stop	00	
Pr.03	Maximum Output Frequency	50.00 to 400.0 Hz	60.00	
Pr.04	Maximum Voltage Frequency (Base Frequency)	10.00 to 400.0Hz	60.00	
Pr.05	Maximum Output Voltage (Vmax)	115V/230V: 0.1 to 255.0V 460V: 0.1 to 510.0V 575V: 0.1 to 637.0V	220.0 440.0 575.0	
Pr.06	Mid-point Frequency	0.10 to 400.0Hz	1.50	
Pr.07	Mid-point Voltage	115V/230V: 0.1 to 255.0V 460V: 0.1 to 510.0V 575V: 0.1 to 637.0V	10.0 20.0 26.1	
Pr.08	Minimum Output Freq	0.10 to 20.00Hz	1.50	
Pr.09	Minimum Output Voltage	115V/230V: 0.1 to 255.0V 460V: 0.1 to 510.0V 575V: 0.1 to 637.0V	10.0 20.0 26.1	
↗Pr.10	Acceleration Time 1	0.1 to 600.0 sec or 0.01 to 600.0 sec	10.0	
↗Pr.11	Deceleration Time 1	0.1 to 600.0 sec or 0.01 to 600.0 sec	10.0	
↗Pr.12	Acceleration Time 2	0.1 to 600.0 sec or 0.01 to 600.0 sec	10.0	
↗Pr.13	Deceleration Time 2	0.1 to 600.0 sec or 0.01 to 600.0 sec	10.0	
Pr.14	Accel S-curve	00 to 07	00	
↗Pr.15	Jog Accel/Decel Time	0.1 to 600.0 sec or 0.01 to 600.0 sec	1.0	

Parameter	Explanation	Settings	Factory Setting	Customer
Pr.16	Jog Frequency	0.00 to 400.0 Hz	6.00	
Pr.17	1st Step Speed Freq.	0.00 to 400.0Hz	0.00	
Pr.18	2nd Step Speed Freq.	0.00 to 400.0Hz	0.00	
Pr.19	3rd Step Speed Freq.	0.00 to 400.0Hz	0.00	
Pr.20	4th Step Speed Freq.	0.00 to 400.0Hz	0.00	
Pr.21	5th Step Speed Freq.	0.00 to 400.0Hz	0.00	
Pr.22	6th Step Speed Freq.	0.00 to 400.0Hz	0.00	
Pr.23	7th Step Speed Freq.	0.00 to 400.0Hz	0.00	
Pr.24	Reserve Operation Inhibition	00: Enable REV operation 01: Disable REV operation	00	
Pr.25	Over-Voltage Stall Prevention	00: Disable 115V/230V: 330 to 450 Vdc 460V: 660 to 900 Vdc 575V: 825 to 1025 Vdc	390 780 975	
Pr.26	Over-current Stall Prevention during Acceleration	00: Disable 20% to 200%	150	
Pr.27	Over-current Stall Prevention during Operation	00: Disable 20% to 200%	150	
Pr.28	DC Braking Current Level	00 to 100 %	00	
Pr.29	DC Braking during Start-up	0.0 to 5.0 sec	0.0	
Pr.30	DC Braking during Stopping	0.0 to 25.0 sec	0.0	
Pr.31	Start-point for DC Braking	0.00 to 60.00 Hz	0.00	
Pr.32	Momentary Power Loss Operation Selection	00: Stop operation after momentary power loss 01: Continues after momentary power loss, speed search starts with Master Frequency 02: Continues after momentary power loss, speed search starts with Minimum output Frequency	00	
Pr.33	Maximum Allowable Power Loss Time	0.3 to 5.0 sec	2.0	
Pr.34	Base-Block Time for Speed Search	0.3 to 5.0 sec	0.5	
Pr.35	Maximum Current Level for Speed Search	30 to 200 %	150	
Pr.36	Upper Bound of Output Frequency	0.10 Hz to 400.0 Hz	400.0	
Pr.37	Lower Bound of Output Frequency	0.00 Hz to 400.0 Hz	0.00	

Parameter	Explanation	Settings	Factory Setting	Customer
Pr.38	Multi-function Input Terminal (M0,M1)	00: M0: FWD/STOP, M1: REV/STOP 01: M0: RUN/STOP, M1: REV/FWD 02: M0, M1, M2: 3-wire operation control mode	00	
Pr.39	Multi-function Input Terminal (M2)	00: No Function 01: Output OFF (N.O.) (enabled when running) 02: Output OFF (N.C.) (enabled when running) 03: External Fault (normally open) N.O. 04: External Fault (normally close) N.C 05: RESET 06: Multi-Step Speed Command 1 07: Multi-Step Speed Command 2 08: Multi-Step Speed Command 3 09: Jog Operation 10: Accel/Decel Speed Inhibit 11: First or Second Accel/Decel Time 12: Base-block (B.B.) (N.O) 13: Base-block (B.B.) (N.C) 14: Increase Master Frequency 15: Decrease Master Frequency	05	
Pr.40	Multi-function Input Terminal (M3)	16: Run PLC Program 17: Pause PLC 18: Counter Trigger Signal	06	
Pr.41	Multi-function Input Terminal (M4)	19: Counter Reset 20: No function 21: RESET command (N.C)	07	
Pr.42	Multi-function Input Terminal (M5)	22: Control source: External Terminal 23: Control source: Keypad 24: Control source: Communication 25: Parameter Lock (Write disable, Read is always 0) 26: PID Disable (N.O.) 27: PID Disable (N.C.) 28: Second Source for Frequency Command 29: Forward (contact is open) / Reverse (contact is close) 30: One-Shot PLC Run 31: Index input signal 32: Counter Incremented by Drive Output Frequency	08	
↗Pr.43	Analog Output Signal	00: Analog Frequency Meter (0 to Maximum Output Frequency) 01: Analog Current Meter (0 to 250% of the rated AC drive current) 02: Feedback signal (0 - 100%) 03: Output power (0 - 100%)	00	
↗Pr.44	Analog Output Gain	00 to 200 %	100	

Parameter	Explanation	Settings	Factory Setting	Customer
Pr.45	Multi-Function Output Terminal 1 (Photocoupler output)	00: AC Drive Operational 01: Maximum Output Frequency Attained 02: Zero Speed 03: Over-Torque Detection 04: Base-Block (B.B) Indication 05: Low Voltage Indication 06: AC Drive Operation Mode 07: Fault Indication 08: Desired Frequency Attained 09: PLC Program Running 10: PLC Program Step Completed 11: PLC Program Completed 12: PLC Operation Paused 13: Top Count Value Attained	00	
Pr.46	Multi-function Output Terminal 2 (Relay Output)	14: Preliminary Counter Value Attained 15: Warning (PID feedback loss, communication error) 16: Below the Desired Frequency 17: PID supervision 18: Over Voltage supervision 19: Over Heat supervision 20: Over Current stall supervision 21: Over Voltage stall supervision 22: Forward command 23: Reverse command 24: Zero Speed (Includes Drive Stop)	07	
↗Pr.47	Desired Frequency Attained	0.00 to 400.0 Hz	0.00	
↗Pr.48	Adjust Bias of External Input Frequency	0.00 to 200.0%	0.00	
↗Pr.49	Potentiometer Bias Polarity	00: Positive Bias 01: Negative Bias	00	
↗Pr.50	Potentiometer Frequency Gain	0.10 to 200.0%	100.0	
Pr.51	Potentiometer Reverse Motion Enable	00: Reverse Motion Disabled in negative bias 01: Reverse Motion Enabled in negative bias	00	
↗Pr.52	Motor Rated Current	30.0% FLA to 120.0% FLA	FLA	
↗Pr.53	Motor No-Load Current	00%FLA to 99%FLA	0.4* FLA	
↗Pr.54	Torque Compensation	00 to 10	00	
↗Pr.55	Slip Compensation	0.00 to 10.00	0.00	
Pr.56	Reserved			
Pr.57	AC Drive Rated Current Display (unit: 0.1A)		###	
Pr.58	Electronic Thermal Overload Relay	00: Standard Motor (self cool motor) 01: Inverter Motor (auxiliary cool fan on motor) 02: Inactive	02	

Parameter	Explanation	Settings	Factory Setting	Customer
↗ Pr.59	Electronic Thermal Motor Overload	30 to 300 sec	60	
Pr.60	Over-Torque Detection Mode	00: Over-Torque Detection Disable 01: Enabled during constant speed operation until the allowable time for detection (Pr.62) elapses. 02: Enabled during constant speed operation and halted after detection. 03: Enabled during acceleration until the allowable time for detection (Pr.62) elapses. 04: Enabled during acceleration and halted after detection.	00	
Pr.61	Over-Torque Detection Level	30 to 200 %	150	
Pr.62	Over-Torque Detection Time	0.0 to 10.0 seconds	0.1	
Pr.63	Loss of ACI (4-20mA)	00: Decelerate to 0 Hz 01: Stop immediately and display "EF" 02: Continue operation by last frequency command	00	
↗ Pr.64	User Defined Function for Display	00: Display AC drive output Frequency (Hz) 01: Display User-defined output Frequency (H*Pr.65) 02: Output Voltage (E) 03: DC Bus Voltage (u_) 04: PV (i) 05: Display the value of internal counter (c) 06: Display the setting frequency (F or o=%) 07: Display the parameter setting (Pr.00) 08: Reserved 09: Output Current (A) 10: Display program operation (0.xxx), Fwd, or Rev	06	
↗ Pr.65	Coefficient K	0.01 to 160.0	1.00	
↗ Pr.66	Communication Frequency	0.00 to 400.0 Hz	0.00	
Pr.67	Skip Frequency 1	0.00 to 400.0 Hz	0.00	
Pr.68	Skip Frequency 2	0.00 to 400.0 Hz	0.00	
Pr.69	Skip Frequency 3	0.00 to 400.0 Hz	0.00	
Pr.70	Skip Frequency Band	0.00 to 20.00 Hz	0.00	
Pr.71	PWM Carrier Frequency	01 to 15 The factory setting of VFD075M43A is 10. 575V series: 01 to 10	15 6	
Pr.72	Auto Restart Attempts after Fault	00 to 10	00	

Parameter	Explanation	Settings	Factory Setting	Customer
Pr.73	Present Fault Record	00: No fault occurred	00	
Pr.74	Second Most Recent Fault Record	01: Over-current (oc) 02: Over-voltage (ov) 03: Overheat (oH) 04: Overload (oL)		
Pr.75	Third Most Recent Fault Record	05: Overload 1 (oL1) 06: External Fault (EF) 07: CPU failure 1 (CF1) 08: CPU failure 3 (CF3) 09: Hardware Protection Failure (HPF) 10: Over-current during acceleration (oca) 11: Over-current during deceleration (ocd) 12: Over-current during steady state operation (ocn) 13: Ground fault or fuse failure(GFF) 14: Low Voltage (not record) 15: 3 Phase Input Power Loss 16: EPROM failure (CF2) 17: External interrupt allowance(bb) 18: Overload (oL2) 19: Auto Adjustable accel/decel failure (CFA) 20: CPU self detection failure (codE)	00	
Pr.76	Parameter Lock and Configuration	00: All parameters can be set/read 01: All parameters are read-only 02-08: Reserved 09: Resets all parameters to 50Hz factory defaults 10: Resets all parameters to 60Hz factory defaults	00	
Pr.77	Time for Auto Reset the Restart Times in Abnormality	0.1 to 6000.0 sec	60.0	
Pr.78	PLC Operation Mode	00: Disable PLC operation 01: Execute one program cycle 02: Continuously execute program cycles 03: Execute one program cycle step by step 04: Continuously execute one program cycle step by step	00	
Pr.79	PLC FWD/REV Motion	00 to 127	00	
Pr.80	Identity Code of the AC Motor Drive	Read only	##	
Pr.81	Time Duration of 1st Step Speed	00 to 9999 sec	00	
Pr.82	Time Duration of 2nd Step Speed	00 to 9999 sec	00	
Pr.83	Time Duration of 3rd Step Speed	00 to 9999 sec	00	

Parameter	Explanation	Settings	Factory Setting	Customer
Pr.84	Time Duration of 4th Step Speed	00 to 9999 sec	00	
Pr.85	Time Duration of 5th Step Speed	00 to 9999 sec	00	
Pr.86	Time Duration of 6th Step Speed	00 to 9999 sec	00	
Pr.87	Time Duration of 7th Step Speed	00 to 9999 sec	00	
Pr.88	Communication Address	01 to 254	01	
Pr.89	Transmission Speed	00: 4800 bps 01: 9600 bps 02: 19200 bps 03: 38400 bps	01	
Pr.90	Transmission Fault Treatment	00: Warn and Continue Operating 01: Warn and RAMP to Stop 02: Warn and COAST to Stop 03: Keep Operation without Warning	03	
Pr.91	Time Out Detection	0.0: Disable 0.1 to 120.0 sec	0.0	
Pr.92	Communication Protocol	00: MODBUS ASCII mode, <7,N,2> 01: MODBUS ASCII mode, <7,E,1> 02: MODBUS ASCII mode, <7,O,1> 03: MODBUS RTU mode, <8,N,2> 04: MODBUS RTU mode, <8,E,1> 05: MODBUS RTU mode, <8,O,1>	00	
Pr.93	Accel 1 to Accel 2 Frequency Transition	0.01 to 400.0 0.00: Disable	0.00	
Pr.94	Decel 1 to Decel 2 Frequency Transition	0.01 to 400.0 0.00: Disable	0.00	
Pr.95	Auto Energy Saving	00: Disable auto energy saving 01: Enable auto energy saving	00	
Pr.96	Counter Countdown Complete	00 to 9999	00	
Pr.97	Preset counter countdown	00 to 9999	00	
Pr.98	Total Time Count from Power On (Days)	00 to 65535 days	Read Only	
Pr.99	Total Time Count from Power On (Minutes)	00 to 1440 minutes	Read Only	
Pr.100	Software Version		##	
Pr.101	Auto Adjustable Accel/Decel	00: Linear Accel/Decel 01: Auto Accel, Linear Decel 02: Linear Accel, Auto Decel 03: Auto Accel/Decel 04: Linear Accel/Decel Stall Prevention during Deceleration	00	

Parameter	Explanation	Settings	Factory Setting	Customer
Pr.102	Auto Voltage Regulation (AVR)	00: AVR function enabled 01: AVR function disabled 02: AVR function disabled when stops 03: AVR function disabled when decel	00	
Pr.103	Auto tune Motor Parameters	00: Disable 01: Auto tune for R1 02: Auto tune for R1 + No Load testing	00	
Pr.104	R1 value	00 to 65535 mΩ	00	
Pr.105	Control Mode	00: V/F Control 01: Sensor-less Control	00	
Pr.106	Rated Slip	0.00 to 10.00 Hz	3.00	
Pr.107	Vector Voltage Filter	5 to 9999 (per 2ms)	10	
Pr.108	Vector Slip Compensation Filter	25 to 9999 (per 2ms)	50	
Pr.109	Selection for Zero Speed Control	00: No output 01: Control by DC voltage	00	
Pr.110	Voltage of Zero Speed Control	to 20.0 % of Max. output voltage (Pr.05)	5.0	
Pr.111	Decel S-curve	00 to 07	00	
Pr.112	External Terminal Scanning Time	01 to 20	01	
Pr.113	Restart Method after Fault (oc, ov, BB)	00: None speed search 01: Continue operation after fault speed search from speed reference 02: Continue operation after fault speed search from Minimum speed	01	
Pr.114	Cooling Fan Control	00: Fan Off when the drive stop after 1 Min. 01: AC Drive Runs and Fan On, AC Drive Stops and Fan Off 02: Always Run 03: Reserved	02	
Pr.115	PID Set Point Selection	00: Disable 01: Keypad (based on Pr.00 setting) 02: AVI (external 0-10V) 03: ACI (external 4-20mA) 04: PID set point (Pr.125)	00	
Pr.116	PID Feedback Terminal Selection	00: Input positive PID feedback, PV from AVI (0 to 10V) 01: Input negative PID feedback, PV from AVI (0 to 10V) 02: Input positive PID feedback, PV from ACI (4 to 20mA) 03: Input negative PID feedback, PV from ACI (4 to 20mA)	00	
Pr.117	Proportional Gain (P)	0.0 to 10.0	1.0	
Pr.118	Integral Time (I)	0.00: Disable 0.01 to 100.0 sec	1.00	

Parameter	Explanation	Settings	Factory Setting	Customer
Pr.119	Differential Time (D)	0.00 to 1.00 sec	0.00	
Pr.120	Integration's Upper Bound Frequency	00 to 100 %	100 %	
Pr.121	One-Time Delay	0.0 to 2.5 sec	0.0	
Pr.122	PID Frequency Output Command Limit	00 to 110 %	100	
Pr.123	Feedback Signal Detection Time	0.0: Disable 0.1 to 3600 sec	60.0	
Pr.124	Feedback Signal Fault Treatment	00: Warning and RAMP to stop 01: Warning and keep operating	00	
Pr.125	Source of PID Set Point	0.00 to 400.0Hz	0.00	
Pr.126	PID Offset Level	1.0 to 50.0 %	10.0	
Pr.127	Detection Time of PID Offset	0.1 to 300.0 sec	5.0	
Pr.128	Minimum Reference Value	0.0 to 10.0 V	0.0	
Pr.129	Maximum Reference Value	0.0 to 10.0 V	10.0	
Pr.130	Invert Reference Signal AVI (0-10V)	00: Not inverted 01: Inverted	00	
Pr.131	Minimum Reference Value (4-20mA)	0.0 to 20.0mA	4.0	
Pr.132	Maximum Reference Value (4-20mA)	0.0 to 20.0mA	20.0	
Pr.133	Invert Reference Signal (4-20mA)	00: Not inverted 01: Inverted	00	
Pr.134	Analog Input Delay Filter for Set Point	00 to 9999 (per 2ms)	50	
Pr.135	Analog Input Delay Filter for Feedback Signal	00 to 9999 (per 2ms)	5	
Pr.136	Sleep Period	0.0 to 6550.0 sec	0.0	
Pr.137	Sleep Frequency	0.00 to 400.0 Hz	0.00	
Pr.138	Wake Up Frequency	0.00 to 400.0 Hz	0.00	
Pr.139	Treatment for Counter Attained	00: Continue operation 01: Stop Immediately and display E.F.	00	
Pr.140	External Up/Down Selection	00: Fixed Mode (keypad) 01: By Accel or Decel Time 02: Reserved	00	
Pr.141	Save Frequency Set Point	00: Not Save 01: Save	01	

Parameter	Explanation	Settings	Factory Setting	Customer
Pr.142	Second Source of Frequency Command	00: Keypad Up/Down 01: AVI (0-10V) 02: ACI (4-20mA) 03: Communication 04: Keypad potentiometer	00	
Pr.143	Software Braking Level	115V/230V	370-450 Vdc	380.0
		460V	740-900 Vdc	760.0
		575V	925-1075 Vdc	950.0
Pr.144	Total operation time (Day)	Read Only		
Pr.145	Total operation time (Minutes)	Read Only		
Pr.146	Line start Lockout	00: Disable 01: Enable	00	
Pr.147	Decimal Number of Accel / Decel Time	00: One decimal 01: Two decimals	00	
Pr.148	Number of Motor Poles	02 to 20	04	
Pr.149	Gear Ratio for Simple Index Function	4 to 1000	200	
Pr.150	Index Angle for Simple Index Function	00.0 to 360.0	180.0	
Pr.151	Deceleration Time for Simple Index Function	0.00 to 100.00 sec	0.00	
Pr.152	Skip Frequency Width	0.00 to 400.0Hz	0.00	
Pr.153	Bias Frequency Width	0.00 to 400.0Hz	0.00	
Pr.154	Reserved			
✳Pr.155	Compensation Coefficient for Motor Instability	0.0: Disable 0.1 to 5.0 (recommended setting d2.0)	0.0	
✳Pr.156	Communication Response Delay Time	0 to 200 (x500us)	0	
✳Pr.157	Communication Mode Selection	0: Delta ASCII 1: Modbus	1	

Fault Codes

Fault Name	Fault Descriptions	Corrective Actions
oC	Over current Abnormal increase in current.	<ol style="list-style-type: none"> 1. Check whether the motors horsepower corresponds to the AC drive output power. 2. Check the wiring connections between the AC drive and motor for possible short circuits. 3. Increase the Acceleration time (Pr.10, Pr.12). 4. Check for possible excessive loading conditions at the motor. 5. If there are any abnormal conditions when operating the AC drive after short-circuit being removed, it should be sent back to manufacturer.
oU	Over voltage The DC bus voltage has exceeded its maximum allowable value.	<ol style="list-style-type: none"> 1. Check whether the input voltage falls within the rated AC drive input voltage. 2. Check for possible voltage transients. 3. Bus over-voltage may also be caused by motor regeneration. Either increase the decel time or add an optional brake resistor. 4. Check whether the required braking power is within the specified limits.
oH	Overheating Heat sink temperature too high	<ol style="list-style-type: none"> 1. Ensure that the ambient temperature falls within the specified temperature range. 2. Make sure that the ventilation holes are not obstructed. 3. Remove any foreign objects from the heatsinks and check for possible dirty heat sink fins. 4. Check the fan and clean it. 5. Provide enough spacing for adequate ventilation.
oL	Low voltage The AC motor drive detects that the DC bus voltage has fallen below its minimum value.	<ol style="list-style-type: none"> 1. Check whether the input voltage falls within the AC motor drive rated input voltage range. 2. Check whether the motor has sudden load. 3. Check for correct wiring of input power to R-S-T (for 3-phase models) without phase loss.
oL	Overload The AC motor drive detects excessive drive output current.	<ol style="list-style-type: none"> 1. Check whether the motor is overloaded. 2. Reduce torque compensation setting in Pr.54. 3. Take the next higher power AC motor drive model. <p>NOTE: The AC motor drive can withstand up to 150% of the rated current for a maximum of 60 seconds.</p>
oL 1	Overload 1 Internal electronic overload trip	<ol style="list-style-type: none"> 1. Check for possible motor overload. 2. Check electronic thermal overload setting. 3. Use a higher power motor. 4. Reduce the current level so that the drive output current does not exceed the value set by the Motor Rated Current Pr.52.
oL 2	Overload 2 Motor overload.	<ol style="list-style-type: none"> 1. Reduce the motor load. 2. Adjust the over-torque detection setting to an appropriate setting.

Fault Name	Fault Descriptions	Corrective Actions
ocR	Over-current during acceleration	<ol style="list-style-type: none"> Short-circuit at motor output: Check for possible poor insulation at the output lines. Torque boost too high: Decrease the torque compensation setting in Pr.54. Acceleration Time too short: Increase the Acceleration Time. AC motor drive output power is too small: Replace the AC motor drive with the next higher power model.
ocd	Over-current during deceleration	<ol style="list-style-type: none"> Short-circuit at motor output: Check for possible poor insulation at the output line. Deceleration Time too short: Increase the Deceleration Time. AC motor drive output power is too small: Replace the AC motor drive with the next higher power model.
ocn	Over-current during steady state operation	<ol style="list-style-type: none"> Short-circuit at motor output: Check for possible poor insulation at the output line. Sudden increase in motor loading: Check for possible motor stall. AC motor drive output power is too small: Replace the AC motor drive with the next higher power model.
cF1	Internal EEPROM can not be programmed.	<ol style="list-style-type: none"> Turn off the power. Check whether the input voltage falls within the rated AC drive input voltage. Turn on the power.
cF2	Internal EEPROM can not be read.	<ol style="list-style-type: none"> Check the connections between the main control board and the power board Reset the drive to the factory settings.
EF	External Fault	<ol style="list-style-type: none"> Input EF (N.O.) on external terminal is closed to GND. Output U, V, W will be turned off. Give RESET command after fault has been cleared.
cFR	Auto accel/decel failure	<ol style="list-style-type: none"> Check if the motor is suitable for operation by AC motor drive. Check if the regenerative energy is too large. Load may have changed suddenly.
GF	Ground fault	<p>When (one of) the output terminal(s) is grounded, short circuit current is more than 50% of AC motor drive rated current, the AC motor drive power module may be damaged.</p> <p>NOTE: The short circuit protection is provided for AC motor drive protection, not for protection of the user.</p> <ol style="list-style-type: none"> Check whether the IGBT power module is damaged. Check for possible poor insulation at the output line.
cE1	Communication error (see Pr.92)	<ol style="list-style-type: none"> Check the connection between the AC drive and computer for loose wires. Check if the communication protocol is properly set.
bb	External Base Block.	<ol style="list-style-type: none"> When the external input terminal (B.B) is active, the AC motor drive output will be turned off. Deactivate the external input terminal (B.B) to operate the AC motor drive again.
HPF	OC hardware error	Return to the factory.

Fault Name	Fault Descriptions	Corrective Actions
<i>HPF</i>	CC (current clamp)	Return to the factory.
<i>HPF</i>	OV hardware error	
<i>HPF</i>	GFF hardware error	
<i>cF3</i>	OV or LV	
<i>cF3</i>	Current sensor error	
<i>cF3</i>	U-phase error	
<i>cF3</i>	W-phase error	
<i>PHL</i>	Phase Loss	Check input phase wiring for loose contacts.
<i>codE</i>	Software protection failure	Return to the factory.
<i>FbE</i>	PID feedback signal error	<ol style="list-style-type: none"> 1. Check parameter settings (Pr.116) and AVI/ACI wiring. 2. Check for possible fault between system response time and the PID feedback signal detection time (Pr.123)

Dimensions

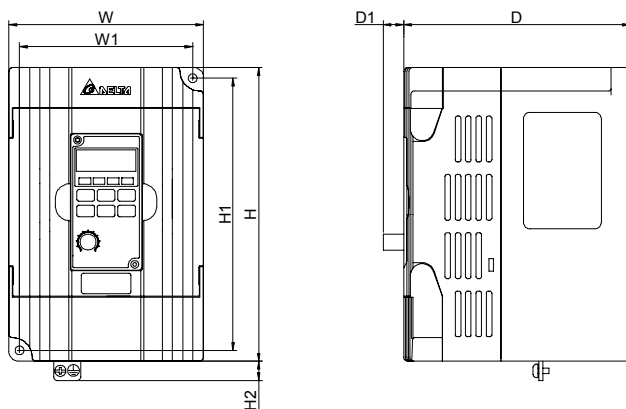

Unit: mm [inch]

Model Name	W	W1	H	H1	H2	D	D1
VFD004M21A/23A, VFD007M21A/23A, VFD015M21A/23A	85.0 [3.35]	74.0 [2.91]	141.5 [5.57]	130.5 [5.14]	10.0 [0.39]	113.0 [4.45]	10.0 [0.39]
VFD002M11A, VFD004M11A/21B, VFD007M11A/21B/43B/53A, VFD015M21B/43B/53A, VFD022M23B/43B/53A	100.0 [3.94]	89.0 [3.50]	151.0 [5.94]	140.0 [5.51]	10.0 [0.39]	116.5 [4.59]	10.5 [0.41]

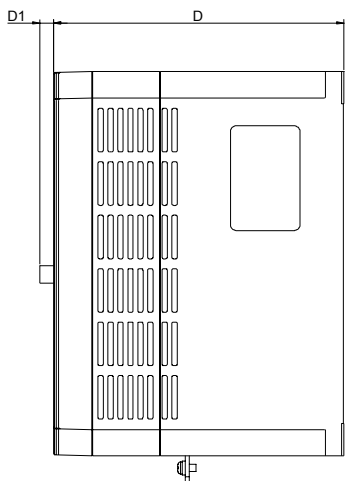
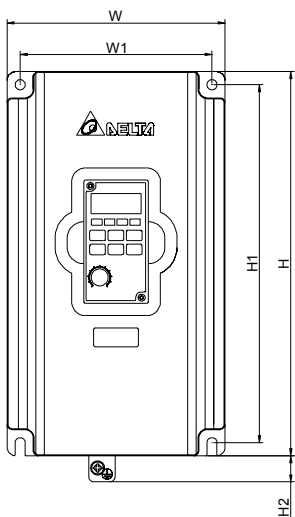

Unit: mm [inch]

Model Name	W	W1	H	H1	H2	D	D1
VFD022M21A, VFD037M23A/43A/53A, VFD055M23A/43A/53A, VFD075M43A/53A	125.0 [4.92]	110.0 [4.33]	220.0 [8.66]	205.0 [8.07]	15.0 [0.59]	166.3 [6.55]	8.2 [0.32]