

# User's Manual

# RadiForce®

# GS520-BL

# GS520-CL

# GS520-BLG

# GS520-CLG

Monochrome LCD Monitor

English

Deutsch

Français

中文

日本語

## Important

Please read this User's Manual carefully to familiarize yourself with safe and effective usage procedures. Please retain this manual for future reference.

## Wichtig

Bitte lesen Sie diese Bedienungsanleitung sorgfältig durch, um sich mit dem sicheren und rationellen Betrieb dieses Produkts vertraut zu machen. Bewahren Sie das vorliegende Handbuch zu Referenzzwecken auf.

## Important

Veillez lire attentivement ce manuel d'utilisation pour utiliser pleinement votre appareil en toute sécurité. Veuillez conserver ce manuel pour référence ultérieure.

## 重要

请仔细阅读用户指南，熟练掌握其安全和有效的操作程序。  
请妥善保存此手册，供日后参考。

## 重要

ご使用前には必ず取扱説明書をよくお読みになり、正しくお使いください。  
この取扱説明書は大切に保管してください。



For U.S.A. , Canada, etc. (rated 100-120 Vac) Only

## FCC Declaration of Conformity

**We, the Responsible Party**

EIZO NANAOTECHNOLOGIES INC.

5710 Warland Drive, Cypress, CA 90630

Phone: (562) 431-5011

**declare that the product**

Trade name: EIZO

Model: RadiForce GS520

**is in conformity with Part 15 of the FCC Rules. Operation of this product is subject to the following two conditions: (1) this device may not cause harmful interference, and (2) this device must accept any interference received, including interference that may cause undesired operation.**

This equipment has been tested and found to comply with the limits for a Class B digital device, pursuant to Part 15 of the FCC Rules. These limits are designed to provide reasonable protection against harmful interference in a residential installation. This equipment generates, uses, and can radiate radio frequency energy and, if not installed and used in accordance with the instructions, may cause harmful interference to radio communications. However, there is no guarantee that interference will not occur in a particular installation. If this equipment does cause harmful interference to radio or television reception, which can be determined by turning the equipment off and on, the user is encouraged to try to correct the interference by one or more of the following measures.

- \* Reorient or relocate the receiving antenna.
- \* Increase the separation between the equipment and receiver.
- \* Connect the equipment into an outlet on a circuit different from that to which the receiver is connected.
- \* Consult the dealer or an experienced radio/TV technician for help.

Changes or modifications not expressly approved by the party responsible for compliance could void the user's authority to operate the equipment.

### Note

Use the attached specified cable below or EIZO signal cable with this monitor so as to keep interference within the limits of a Class B digital device.

- AC Cord
- Shielded Signal Cable (Enclosed)

## Canadian Notice

This Class B digital apparatus complies with Canadian ICES-003.

Cet appareil numérique de la classe B est conforme à la norme NMB-003 du Canada.

# User's Manual





# RadiForce® GS520-BL GS520-CL GS520-BLG GS520-CLG

Monochrome LCD Monitor

It shall be assured that the final system is in compliance to IEC60601-1-1 requirements.

## SAFETY SYMBOLS

This manual uses the safety symbols below. They denote critical information. Please read them carefully.

	<p><b>WARNING</b></p> <p>Failure to abide by the information in a WARNING may result in serious injury and can be life threatening.</p>
	<p><b>CAUTION</b></p> <p>Failure to abide by the information in a CAUTION may result in moderate injury and/or property or product damage.</p>
	<p>Indicates a prohibited action.</p>
	<p>Indicates to ground for safety.</p>

- Power supplied equipment can emit electromagnetic waves, that could influence, limit or result in malfunction of the monitor. Install the equipment in a controlled environment, where such effects are avoided.
- This is a monitor intended for use in a medical image system.
- Product specifications may vary depending on the region. Confirm the specifications in the manual written in the language of the region of purchase.

---

Copyright© 2008 EIZO NANA O CORPORATION All rights reserved. No part of this manual may be reproduced, stored in a retrieval system, or transmitted, in any form or by any means, electronic, mechanical, or otherwise, without the prior written permission of EIZO NANA O CORPORATION.

EIZO NANA O CORPORATION is under no obligation to hold any submitted material or information confidential unless prior arrangements are made pursuant to EIZO NANA O CORPORATION's receipt of said information. Although every effort has been made to ensure that this manual provides up-to-date information, please note that EIZO monitor specifications are subject to change without notice.

---

Apple and Macintosh are registered trademarks of Apple Inc.

VGA is a registered trademark of International Business Machines Corporation.

VESA is a registered trademark of Video Electronics Standards Association.

Windows is a registered trademark of Microsoft Corporation.

RealVision is a registered trademark of RealVision Inc.

Matrox is a registered trademark of Matrox Electronic Systems Ltd.

PowerManager, RadiCS and RadiNET are trademarks of EIZO NANA O CORPORATION.

ScreenManager, RadiForce and EIZO are registered trademarks of EIZO NANA O CORPORATION in Japan and other countries.

---

# TABLE OF CONTENTS

 PRECAUTIONS .....	4
1. Introduction .....	9
1-1. Features .....	9
1-2. Package Contents .....	9
1-3. Controls and Connectors .....	10
2. Installation.....	12
2-1. Before Connecting.....	12
2-2. Cable Connection.....	13
2-3. Environmental Settings .....	16
3. Adjustment and Settings.....	18
3-1. How to use the ScreenManager.....	18
3-2. ScreenManager menu.....	19
3-3. CAL Switch Function.....	23
3-4. Adjustment Lock Function.....	24
4. Brightness Adjustment and Image Adjustment.....	25
4-1. Brightness Adjustment .....	25
4-2. Image Adjustments .....	25
5. Making use of USB (Universal Serial Bus) .....	26
6. Attaching an Arm .....	28
7. Troubleshooting.....	29
8. Cleaning.....	31
9. Specifications.....	32
10. Glossary .....	35

# PRECAUTIONS







## IMPORTANT!

- This product has been adjusted specifically for use in the region to which it was originally shipped.  
If operated outside the region to which it was originally shipped, the product may not perform as stated in the specifications.
- To ensure personal safety and proper maintenance, please read this section and the caution statements on the unit (refer to the figure below).

### [Location of the Caution Statements]



### [Symbols on the unit]

Symbol	Location	This symbol indicates
	Rear	Main power switch Press to turn the monitor's main power off.
	Rear	Main power switch Press to turn the monitor's main power on.
	Front Control Panel	Power switch Press to turn the monitor's power on or off.
	Rear Name Plate	Alternating current
	Rear	Alerting electrical hazard
	Rear	Caution Refer to SAFETY SYMBOLS section in this manual.

## WARNING

**If the unit begins to emit smoke, smells like something is burning, or makes strange noises, disconnect all power connections immediately and contact your dealer for advice.**

Attempting to use a malfunctioning unit may result in fire, electric shock, or equipment damage.

**Do not open the cabinet or modify the unit.**

Opening the cabinet or modifying the unit may result in fire, electric shock, or burn.



**Refer all servicing to qualified service personnel.**

Do not attempt to service this product yourself as opening or removing covers may result in fire, electric shock, or equipment damage.

**Keep small objects or liquids away from the unit.**

Small objects accidentally falling through the ventilation slots into the cabinet or spillage into the cabinet may result in fire, electric shock, or equipment damage. If an object or liquid falls/spills into the cabinet, unplug the unit immediately. Have the unit checked by a qualified service engineer before using it again.



**Place the unit at the strong and stable place.**

A unit placed on an inadequate surface may fall and result in injury or equipment damage. If the unit falls, disconnect the power immediately and ask your dealer for advice. Do not continue using a damaged unit. Using a damaged unit may result in fire or electric shock.



**Set the unit in an appropriate location.**

Not doing so may result in fire, electric shock, or equipment damage.

- Do not place outdoors.
- Do not place in the transportation system (ship, aircraft, trains, automobiles, etc.)
- Do not place in a dusty or humid environment.
- Do not place in a location where the steam comes directly on the screen.
- Do not place near heat generating devices or a humidifier.
- Do not place in an inflammable gas environment.



**To avoid danger of suffocation, keep the plastic packing bags away from babies and children.**

 **WARNING**

---

**Use the enclosed power cord and connect to the standard power outlet of your country.**

Be sure to remain within the rated voltage of the power cord.

Not doing so may result in fire or electric shock.

Power supply: 100-120/200-240 Vac 50/60Hz

---

**To disconnect the power cord, grasp the plug firmly and pull.**

Tugging on the cord may damage and result in fire or electric shock.



**The equipment must be connected to a grounded main outlet.**

Not doing so may result in fire or electric shock.



**Use the correct voltage.**

- The unit is designed for use with a specific voltage only. Connection to another voltage than specified in this Use's Manual may cause fire, electric shock, or equipment damage.

Power supply: 100-120/200-240 Vac 50/60Hz

- Do not overload your power circuit, as this may result in fire or electric shock.
- 

**Handle the power cord with care.**

- Do not place the cord underneath the unit or other heavy objects.
- Do not pull on or tie the cord.

If the power cord becomes damaged, stop using it. Use of a damaged cord may result in fire or electric shock



**Never touch the plug and power cord if it begins to thunder.**

Touching them may result in electric shock.



**When attaching an arm stand, please refer to the user's manual of the arm stand and install the unit securely.**

Not doing so may cause the unit to come unattached, which may result in injury or equipment damage. When the unit is dropped, please ask your dealer for advice. Do not continue using a damaged unit. Using a damaged unit may result in fire or electric shock. When reattaching the tilt stand, please use the same screws and tighten them securely.

---



## WARNING

### **Do not touch a damaged LCD panel directly with bare hands.**

The liquid crystal which leaks from the panel is poisonous if it enters the eyes or mouth.

If any part of the skin or body comes in direct contact with the panel, please wash thoroughly. If some physical symptoms result, please consult your doctor.



**Lamps contain mercury, dispose according to local, state or federal laws.**

## CAUTION

### **Handle with care when carrying the unit.**

Disconnect the power cord and cables when moving the unit. Moving the unit with the cord attached is dangerous. It may result in injury.

### **When handling the unit, grip the bottom of the unit firmly with both hands ensuring the panel faces outward before lifting.**

Dropping the unit may result in injury or equipment damage.



### **Do not block the ventilation slots on the cabinet.**

- Do not place any objects on the ventilation slots.
- Do not install the unit in a closed space.
- Do not use the unit laid down or upside down.

Blocking the ventilation slots prevents proper airflow and may result in fire, electric shock, or equipment damage.



### **Do not touch the plug with wet hands.**

Doing so may result in electrical shock.



### **Use an easily accessible power outlet.**

This will ensure that you can disconnect the power quickly in case of a problem.

### **Periodically clean the area around the plug.**

Dust, water, or oil on the plug may result in fire.

### **Unplug the unit before cleaning it.**

Cleaning the unit while it is plugged into a power outlet may result in electric shock.

**If you plan to leave the unit unused for an extended period, disconnect the power cord from the wall socket after turning off the power switch for the safety and the power conservation.**

## **Notice for this monitor**

---

---

The backlight of the LCD panel has a fixed life span. When the screen becomes dark or begins to flicker, please contact your dealer.

---

The backlight of the LCD panel has a fixed life span. When the screen becomes dark or begins to flicker, please contact your dealer.

---

Do not press on the panel or edge of the frame strongly, as this may result in damage to the screen. There will be prints left on the screen if the pressed image is dark or black. If pressure is repeatedly applied to the screen, it may deteriorate or damage your LCD panel. Leave the screen white or black to decrease the prints.

---

When the screen image is changed after displaying the same image for extended periods of time, an afterimage may appear. Use the screen saver or timer to avoid displaying the same image for extended periods of time.

---

When the monitor is cold and brought into a room or the room temperature goes up quickly, dew condensation may occur inside and outside the monitor. In that case, do not turn the monitor on and wait until dew condensation disappears, otherwise it may cause some damages to it.

---

Do not scratch or press on the panel with any sharp objects, such as a pencil or pen as this may result in damage to the panel. Do not attempt to brush with tissues as this may scratch the LCD panel.

---

## **To use the monitor comfortably**

---

---

An excessively dark or bright screen may affect your eyes. Adjust the brightness of the monitor according to the environmental conditions.

---

Staring at the monitor for a long time tires your eyes. Take a 10-minute rest every hour.

---

---

# 1. Introduction

Thank you for choosing an EIZO Monochrome Monitor.

## 1-1. Features

- DVI (p.35) digital input (TMDS (p.35)) compliant
- Horizontal scan frequency 31 - 135 kHz
- Vertical scan frequency 19.0 - 61.0 Hz  
(VGA TEXT: 69 - 71 Hz, QSXGA: 19 - 51 Hz,)
- Frame synchronous mode 49.0 - 51.0 Hz supported
- Resolution 5M pixels (Portrait: 2048 × 2560 dots (H × V))
- CAL Switch function for selecting an optimal calibration mode (p. 23)
- Selectable DICOM (p. 35) Part 14 complied screen
- USB (Universal Serial Bus) hub support (p. 26)
- The quality control software “RadiCS LE“ (for Windows) used to calibrate the monitor is included (refer to the EIZO LCD Utility Disk).
- The utility software “ScreenManager Pro for Medical“ (for Windows) to control the monitor from a PC with mouse/keyboard is included (refer to the EIZO LCD Utility Disk).
- The height adjustable stand incorporated
- Slim bezel

## 1-2. Package Contents

Please contact your local dealer for assistance if any of the listed items are missing or damaged.

- |                             |  |
|-----------------------------|--|
| • LCD Monitor* <sup>1</sup> | • User's Manual  |
| • Power Cord                | • LIMITED WARRANTY   |
| • Signal Cable (FD-C39)     | • Cleaning Kit “ScreenCleaner”<br>(GS520-BLG / GS520-CLG only) |
| • EIZO USB Cable (MD-C93)   | • Recycling Information  |
| • EIZO LCD Utility Disk     |  |

\*<sup>1</sup> The landscape position is the default monitor orientation. For the portrait position, rotate the monitor ninety degrees counter-clockwise before installing it.

### Tips

- Please retain the packing materials for future transport of the monitor.

# 1-3. Controls and Connectors

## Front

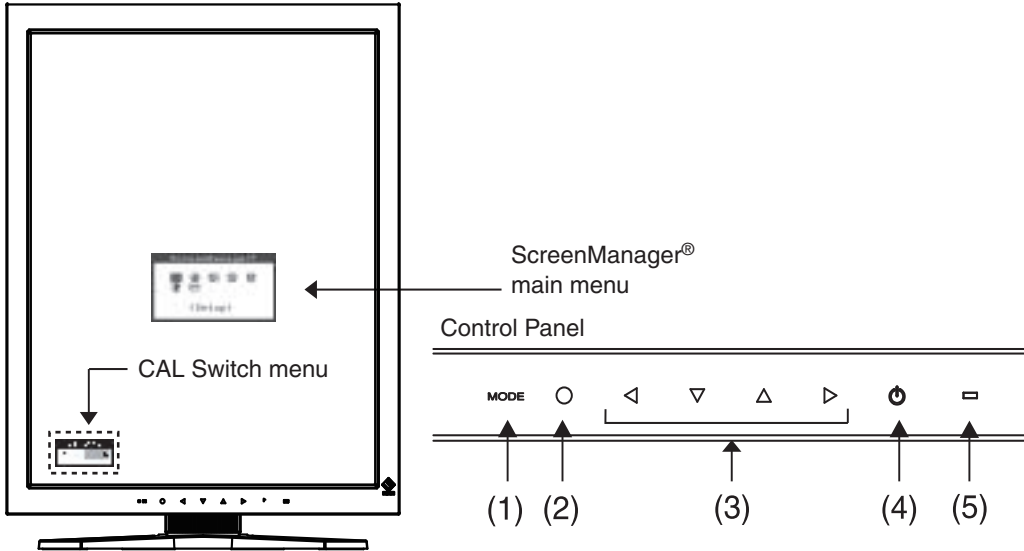

(1)	Mode Switch	Displays the CAL Switch menu (p. 23).
(2)	Enter Switch	Displays the Adjustment menu, determines an item on the menu screen, and saves values adjusted
(3)	Directing Switches* <sup>1</sup> (Left, Down, Up, Right)	Chooses an adjustment item or increases/decreases adjusted values for advanced adjustments using the Adjustment menu (p. 18)
(4)	Power Switch	Turns the power on or off.
(5)	Power indicator* <sup>2</sup>	Indicates monitor's operation status. Green: Operational Orange: Power saving Flashing orange slowly: Power off (Main power is on) Off: Main Power off

\*<sup>1</sup> When the monitor is oriented in the landscape position, these switches can be changed to Up, Left, Right, and Down (p. 16).

\*<sup>2</sup> To disable the power indicator while the monitor is operational, see p. 22. For power indicator status when using the "Off Timer," see p.22.

## Side / Rear

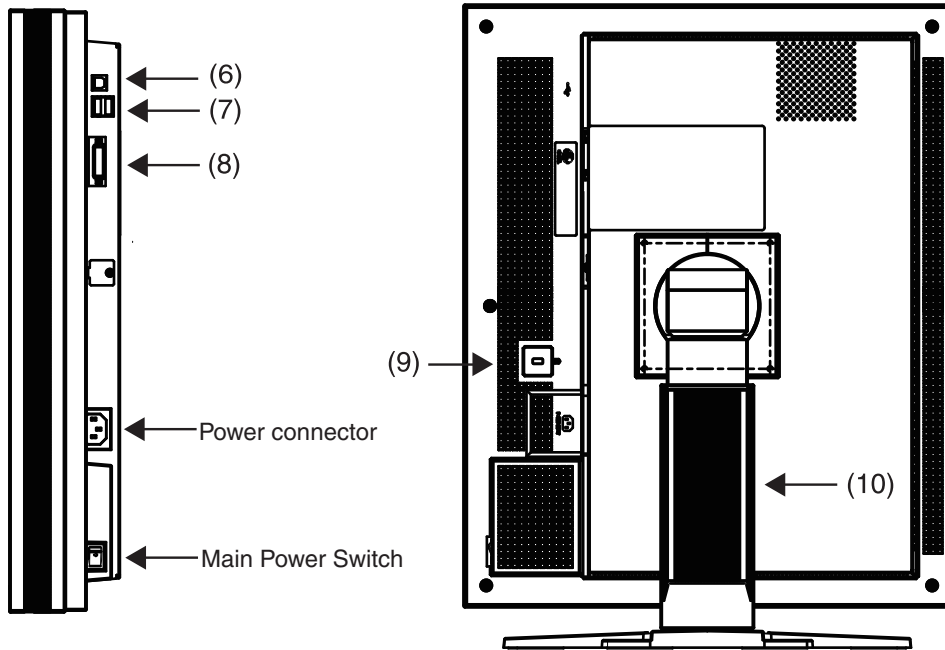

(6)	USB port (Up)	Connects the USB cable in order to use the provided software.
(7)	USB port (Down)	Connects a peripheral USB device.
(8)	Input signal connectors	DVI-D connector
(9)	Security lock slot <sup>*3</sup>	Complies with Kensington's MicroSaver security system.
(10)	Stand <sup>*4</sup>	Used to adjust the height and angle of the monitor screen.

<sup>\*3</sup> Allows for connection of a security cable.

<sup>\*4</sup> The LCD monitor can be oriented in the landscape position. (It can rotate clockwise ninety degrees.)  
By removing the monitor stand, the LCD monitor can be used with the optional arm stand (p. 28).

# 2. Installation

## 2-1. Before Connecting

Before connecting your monitor to the PC, change the display screen settings resolution (p. 35) and frequency in accordance with the charts below.

**Tips**

- When your computer and monitor support VESA DDC, the appropriate resolution and the refresh rate are set just by plugging your display into the computer without any manual settings.

Resolution		Frequency	Dot Clock	Single Link		Dual Link		Packed Pixel	
				Portrait	Land- scape	Portrait	Land- scape	Portrait	Land- scape
720 x 400	VGA TEXT	70 Hz	300 MHz (Max.)	√	√	√	√	√	√
640 x 480	VGA	60 Hz		√	√	√	√	√	√
800 x 600	VESA	60 Hz		√	√	√	√		
1024 x 768	VESA	60 Hz		√	√	√	√		
1280 x 1024	VESA	60 Hz		√	√	√	√		
1600 x 1200	VESA	60 Hz		√	√	√	√		
2048 x 1280	5M Packed Pixel	50 Hz						√	
1280 x 2048	5M Packed Pixel	50 Hz							√
2560 x 2048	Dual Link	50 Hz					√		
2048 x 2560	Dual Link	50 Hz				√			
2560 x 2048	Single Link 25Hz	25 Hz			√				
2048 x 2560	Single Link 25Hz	25 Hz		√					
2560 x 2048	Single Link 20Hz	20 Hz			√				
2048 x 2560	Single Link 20Hz	20 Hz		√					

“√”: Supported

## 2-2. Cable Connection

### NOTE

- Be sure that the power switches of both the PC and the monitor are OFF.
- Refer to the PC user's manual when connecting the monitor.
- Before making a connection for non monochrome signal only specifications, the monitor must be configured. For more information, refer to “2-3. Environmental Settings” (p. 16).

- 1 Rotate the monitor ninety degrees counter-clockwise into the portrait position.

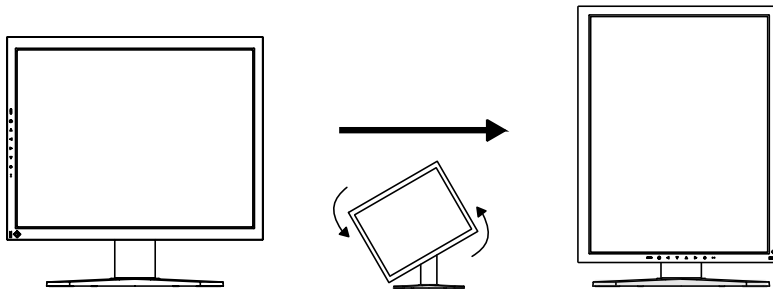

- 2 Connect the signal cable to the DVI-D input connector on the rear of the monitor and to the video output connector on the PC.

After connecting, secure the cable connectors with the attached screw-in fasteners.

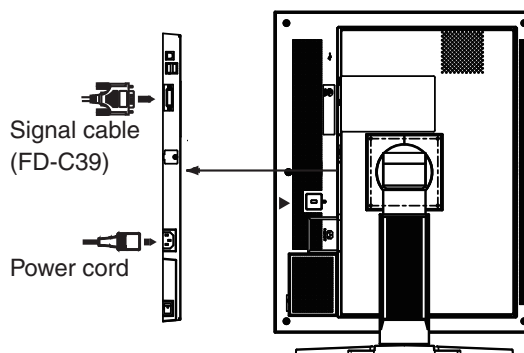

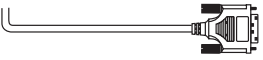
Signal Cable	Connector on PC	PC
Signal cable (FD-C39) 	Video Output Connector / DVI-D	Exclusive graphics board (p. 33)

- 3 Connect the power cord to the power connector on the rear of the monitor.
- 4 Thread the power cord and signal cable through the cable holder on the rear of the monitor stand.

---

**NOTE**

- When threading the cables through the cable holder, lead them to the cable entrance side and pinch the projection to open the cable entrance.
  - It is recommended that some slack be left in the cables to allow for smooth adjustment of the monitor stand and easy rotation between the portrait and landscape positions.
- 

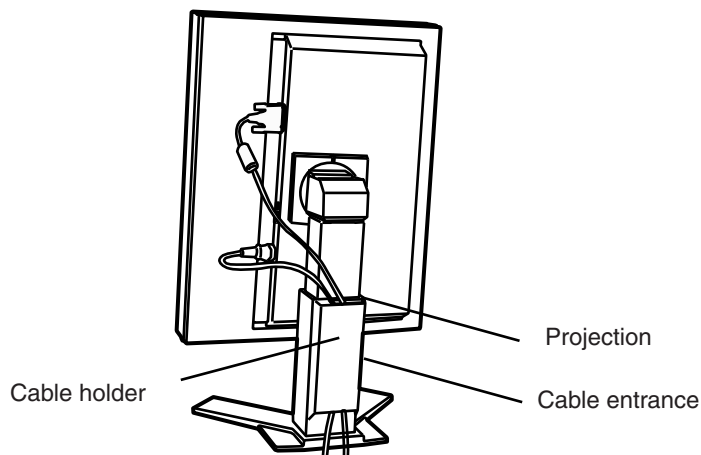

- 5 Connect the other end of the power cord to a power outlet.

 **WARNING**

---

**Use the enclosed power cord and connect to the standard power outlet of your country.**

Be sure to remain within the rated voltage of the power cord. Not doing so may result in fire or electric shock.

---

**The equipment must be connected to a grounded main outlet.**

Not doing so may result in fire or electric shock.



- 6 Turn on the monitor's power by touching the power switch.  
The monitor's power indicator will light up green.



---

## 7 Turn on the PC's power.

The image will appear.

If an image does not appear, refer to “7. Troubleshooting” (p. 29) for additional advice.

When finished, turn off the PC and the monitor.

---

### Tips

- Adjust the brightness of the screen depending on the brightness of your environment.
  - Be sure to take adequate rests. A 10-minute rest period each hour is suggested.
- 

## 8 When using the software “RadiCS LE” (for Windows) or “ScreenManager Pro for Medical” (for Windows) connect the monitor to a USB compliant Windows computer (or other USB hub) with a USB cable.

Refer to “5. Making use of USB (Universal Serial Bus)” (p. 26).

## 2-3. Environmental Settings

The monitor may need to be set in some environment. If you install it for the first time or change environment, set the monitor.

- Set the signal corresponding to make a connection for non monochrome signal only specifications.
- Set the monitor orientation.

If the monitor is in portrait position and make a connection for monochrome signal only specifications, no setting is required.

### NOTE

- Refer to the manual of the graphics board.
- These environment described below can be set regardless of whether or not the computer is running.



### How to set

- 1 Turn off the monitor power by touching the power switch on the control panel.
- 2 Touch the power switch while touching the mode switch on the control panel.

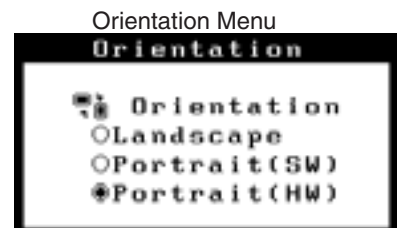
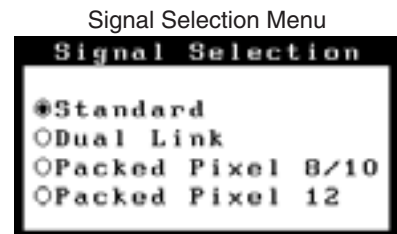

- 3 The <Signal Selection> menu appears. Select (or check) the signal with directing switches corresponding to the kind of graphics board or the image data to be displayed and touch the enter switch.
- 4 Next the <Orientation> menu appears. Select (or check) the orientation with directing switches according to your monitor orientation and touch the enter switch.



Monitor Orientation	Display Example
<p><b>Landscape</b> Select this option when using the Landscape orientation.</p>	
<p><b>Portrait (SW)</b> Select this option when using the Portrait orientation. Graphics board utility software is used to rotate the display image 90 degrees.</p>	
<p><b>Portrait (HW)</b> Select this option when using the Portrait orientation. The monitor function is used to rotate the display image 90 degrees.</p>	

- 5 Restart the computer if the settings have been changed.

# 3. Adjustment and Settings

## 3-1. How to use the ScreenManager

Screen adjustments and settings can be performed with the ScreenManager (OSD) and buttons of the monitor.

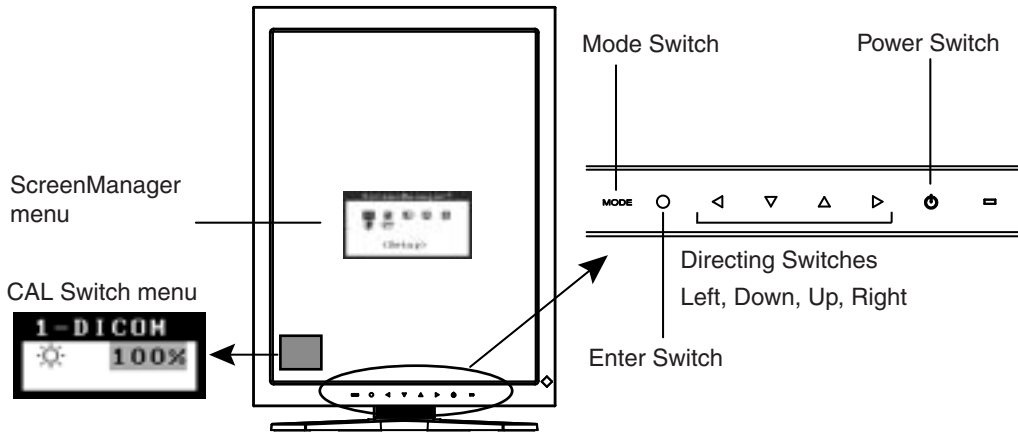

Adjustment	Startup	Description
ScreenManager menu	Enter Switch	3-2. ScreenManager menu (p. 19)
CAL Switch menu	Mode Switch	3-3. CAL Switch Function (p. 23)
Switches		
*Adjustment Lock	Enter Switch + Power Switch	3-4. Adjustment Lock Function (p. 24)
*Signal Selection Orientation Selection	Mode Switch + Power Switch	2-3. Environmental Settings (p. 16)

For information about each function, refer to each chapter described above.

**NOTE**

- The ScreenManager menu and the CAL Switch menu cannot be displayed at the same time.

## 3-2. ScreenManager menu

Using ScreenManager menu controls the screen adjustment and settings. Refer to the “Explanation” column in the following table for each detailed functions.

### Functions

The following table shows all the ScreenManager’s adjustment and setting menus.

Main menu	Sub menu	Explanation	
Setup	Mode Preset	Mode Preset Function <Setup>-<Mode Preset>(P. 21)	
Mode	Brightness	4-1. Brightness Adjustment (p. 25)	
	Reset		
PowerManager	DVI DMPM	Power Saving Function <PowerManager> (p. 21)	
Others	Border Intensity	Image Adjustment <Others>(p.25)	
	Off Timer	Turn off the monitor after a specified time. (p. 22)	
	Menu Settings	Menu Position	Adjust the menu position
		Menu Off Timer	Set the menu displaying time.* <sup>1</sup>
	Power Indicator	Make non-light for Green lighting when the screen is displayed. (p. 22)	
Reset	Return to the factory default settings. (p. 33)		
Information	Information	Review the ScreenManager’s settings, model name, serial number and usage time.* <sup>2</sup>	
Language	English, German, French, Spanish, Italian, Swedish, Chinese (Simplified), Chinese (Traditional) and Japanese	Select the ScreenManager’s language.	

\*<sup>1</sup> The display time of the CAL Switch menu can be adjusted.

\*<sup>2</sup> Due to factory inspection, the usage time may not be “0 hours” at time of shipping.

## **How to use the ScreenManager**

ScreenManager Menu

### **[Entering the ScreenManager]**

Touch the enter switch.



### **[Making adjustments and settings]**

1. Select the desired submenu icon with the directing switches and touch the enter switch.
2. Select the desired setting icon with the directing switches and touch the enter switch.
3. Make any required adjustments with the directing switches and touch the enter switch.

### **[Exiting the ScreenManager]**

1. To return to the main menu, select the <Return> icon or touch the Down directing switch twice, followed by the enter switch.
2. To exit the ScreenManager, select the <Exit> icon or touch the Down directing switch twice, followed by the enter switch.

---

#### **NOTE**

- Touching the enter switch twice quickly also exits the ScreenManager.
-

## Mode Preset Function <Setup>-<Mode Preset>

When CAL Switch mode is selected, the computer can be forced to display only specified modes. Use this function when the display modes are restricted or when the display should not be changed needlessly.

### [How to set]

1. Select <Mode Preset> in the ScreenManager <Setup> menu.
2. Set each mode to “On” or “Off”.

### NOTE

- You cannot disable all modes. Set one or more modes to “On”.

### [How to cancel]

1. Select <Mode Preset> in the ScreenManager <Setup> menu.
2. Set the mode that you wish to display to “On”.

## Power Saving Function <PowerManager>

The <PowerManager> menu in the ScreenManager enables to set the power saving. This monitor complies with the “DVI DMPM” (p. 35).

### NOTE

- Do your part to conserve energy, turn off the monitor when you are finished using it. Disconnecting the monitor from the power supply is recommended to save energy completely.
- Even if the monitor is in a power saving mode, USB compliant devices function when they are connected to the monitor’s USB (both the upstream and the downstream ports). Therefore, power consumption of the monitor will change according to the connected devices even if the monitor is in a power saving mode.

### [How to set]

1. Set the PC’s power saving settings.
2. Select “DVI DMPM” in the <PowerManager> menu.

### [Power saving system]

PC	Monitor	Power Indicator
On	Operation	Green
Power saving/ Off mode	Power saving	Orange

### [Power Resumption Procedure]

Operate the mouse or keyboard to return to a normal screen.

## **Off Timer <Others>-<Off Timer>**

The off timer function causes the monitor to turn off automatically after a predetermined amount of time has lapsed. This function was created to reduce the afterimages particular to LCD monitors, which appear when the screen is left on for long periods without use.

### **[How to set]**

1. Select <Off Timer> in the ScreenManager <Others> menu.
2. Select “Enable” and touch the Right and Left directing switches to adjust the operating time (1 to 23 hours).

### **[Off timer system]**

<b>PC</b>	<b>Monitor</b>	<b>Power Indicator</b>
Operating time (1H - 23H)	Operational	Green
Last 15 min. in operating time	Advance Notice *1	Flashing green
Operating time expired	Power off	Flashing orange slowly

\*1 By touching the power switch on the control panel during the Advance Notice period, the operating time can be reset to 90 minutes. Resetting can be performed an unlimited number of times.

### **[How to restore power]**

Touch the power switch to return to a normal screen.

#### **NOTE**

- The off timer function works while the PowerManager is active, but there is no advance notice before the monitor's power is turned off.
- 

## **Power Indicator Function <Others>-<Power Indicator >**

Use the function to keep the power indicator without light while the monitor is operational. (The power indicator is set by default to light when the power is turned on.)

### **[How to set]**

1. Select <Power Indicator> in the ScreenManager <Others> menu.
2. Select “Disable”.



## 3-3. CAL Switch Function

The most suitable display mode is available by switching the mode switch on the control panel.

The <Brightness> settings can be adjusted on the CAL Switch menu.

### CAL Switch Modes

Mode	Description
1 - DICOM	Used to display images in the DICOM mode (p. 35)
2 - Native	Select this option to display images using the native characteristics of the monitor panel.
3 - CAL	Used for monitor calibration

\* All modes can be calibrated independently. The mode name can also be changed using the calibration kit (p. 34).

### How to use the CAL Switch Function

#### [Entering the CAL Switch menu]

Touch the mode switch.

CAL Switch mode

Brightness

CAL Switch menu



#### [Selecting the CAL Switch mode]

Touch the mode switch while the CAL Switch menu is displayed.

Touching the mode switch allows you to select the following mode.

1-DICOM → 2-Navive → 3-CAL → 1-DICOM

#### [Making brightness adjustments in CAL Switch mode]

1. Touch the mode switch.
2. Adjust the brightness value with the Left and Right directing switches.

#### [Closing the CAL Switch menu]

Touch the enter switch.

#### NOTE

- The ScreenManager menu and CAL Switch menu cannot be displayed at the same time.
- When switching between modes, the monitor can be set to display only the specified modes, skipping any unnecessary modes. (p.21 Mode Preset Function <Setup>-<Mode Preset>)

## 3-4. Adjustment Lock Function

---

Use the “Adjustment Lock” function to prevent any accidental changes.

Locked functions	<ul style="list-style-type: none"><li>• Display, adjustment, and setting of the ScreenManager</li><li>• Brightness adjustments to the CAL Switch mode</li></ul>
Unlocked function	<ul style="list-style-type: none"><li>• Selection of the CAL Switch mode with the mode switch</li></ul>

### [How to lock]

1. Turn off the monitor power by touching the power switch.
2. Touch the power switch while touching the enter switch.

### [How to unlock]

1. Turn off the monitor power by touching the power switch.
2. Touch the power switch while touching the enter switch, and then turn on the monitor again. The adjustment lock is released.

---

#### **NOTE**

- The adjustment lock function may activate when calibration is performed with the calibration kit (p.34). The monitor can be unlocked using the same unlocking procedure described above.
-

# 4. Brightness Adjustment and Image Adjustment

## 4-1. Brightness Adjustment

The brightness of the entire screen can be set to a desired level.

### [How to adjust]

1. Select <Brightness> in the ScreenManager <Mode> menu.
2. Make adjustments with the Left and Right directing switches.  
The Left directing switch makes the screen darker, and the Right directing switch makes it brighter.

### NOTE

- Selecting <Reset> in the <Mode> menu resets the brightness of the selected CAL Switch mode to the factory default setting.

## 4-2. Image Adjustments

When a low-resolution image is displayed, the brightness of the border area surrounding the image (i.e., the dark area where no image appears) can be adjusted.

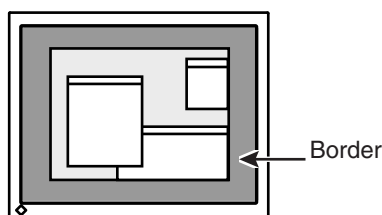

### [How to adjust]

1. Select <Border Intensity> in the ScreenManager <Others> menu.
2. Make adjustments with the Left and Right directing switches. The Left directing switch makes the border darker, and the Right directing switch makes it brighter.

## 5. Making use of USB (Universal Serial Bus)

This monitor provides a hub which supports the USB standard. When connecting to a USB compliant PC or another hub, the monitor functions as a hub to which the USB compliant peripherals can be easily connected.

### **Required system environment**

- PC equipped with USB ports or another USB hub connected to the USB compliant PC
- Windows 2000/XP/Vista // Mac OS 9.2.2 and Mac OS X 10.2 or later
- USB Cable (MD-C93, enclosed)

### **NOTE**

- The USB hub function may not work properly depending on the PC or peripherals. Please consult the manufacturer of each device about the USB support.
- Using the USB Rev. 2.0 compatible PC or peripherals is recommended.
- If the monitor is in the power saving mode, or if the monitor is connected to the power outlet with the monitor turned off, all the devices connected to the USB ports (upstream and downstream) work. Therefore, power consumption of the monitor varies with connected devices even in the power saving mode.
- The followings are procedures for the Windows 2000/XP/Vista and Mac OS.

### **Connecting to the USB HUB**

**1** Connect the monitor to the PC with the signal cable (p. 13) first, then turn on the PC.

**2** Connect the upstream port of the monitor to the downstream port of the USB compliant PC or another hub by using the USB cable.

After connecting the USB cable, the USB function can be set up automatically.

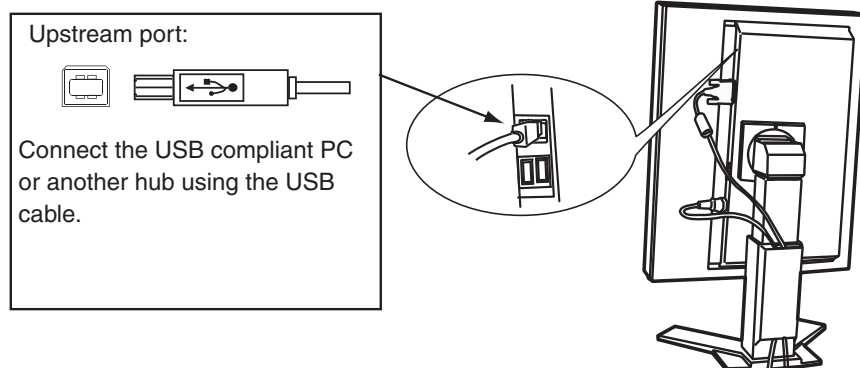

### 3 After setting up, the monitor's USB hub is available for connecting USB compliant peripherals to the downstream ports of the monitor.

Connecting Examples

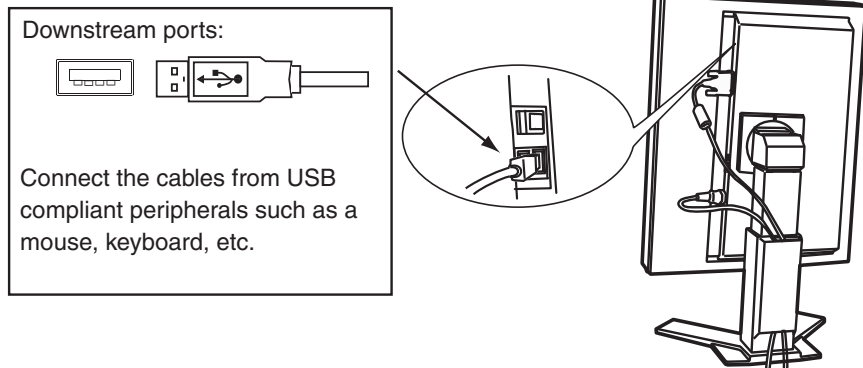
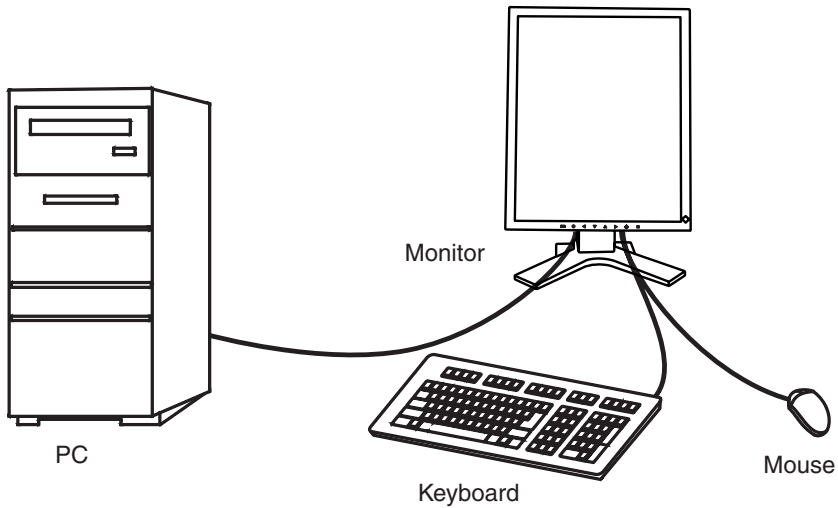

### To use “RadiCS LE” (for Windows) or “ScreenManager Pro for Medical” (for Windows)

Refer to the corresponding User's Manual on the CD-ROM disk in order to install and use the software. When using this software, you will need to connect a PC to the monitor with the supplied USB cable.

# 6. Attaching an Arm

The LCD monitor can be used with an arm by removing the tilt stand and attaching the arm stand to the LCD monitor.

## NOTE

- If you will use the arm or stand of other manufacturers, confirm the followings to the manufacturers before selecting.
    - Hole spacing on the arm mounting  
100 mm x 100 mm (VESA compliant)
    - Supportable Weight: Total weight of the monitor (without stand) and attaching equipment such as a cable
    - TÜV/GS approved arm or stand
  - Please connect cables after attaching an arm stand.
- 

## Setup Procedure

- 1** Hold the center of the stand mounting cover and slide them rightward or leftward to remove the mounting cover.
- 2** Lay the LCD monitor down. Do not scratch the panel.
- 3** Remove the tilt stand by loosening the screws.
- 4** Attach an arm or a stand to the LCD monitor securely.

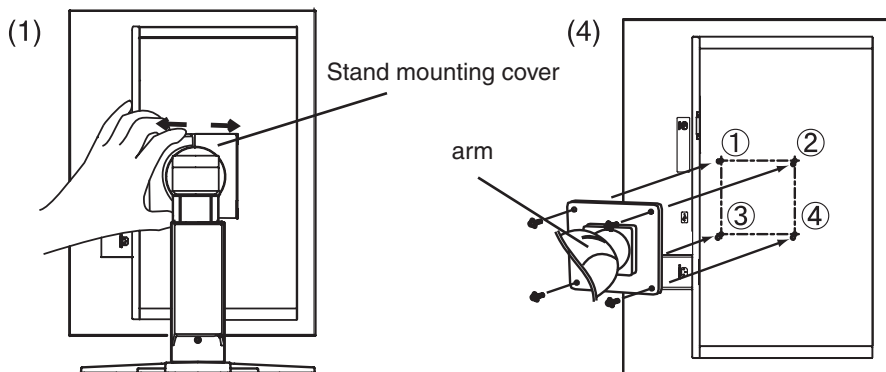

# 7. Troubleshooting

If a problem persists even after applying the suggested remedies, contact an EIZO dealer.

- No picture problems → See No.1 ~ No.2
- Imaging problems → See No.3 ~ No.6
- Other problems → See No.7 ~ No.9
- USB problems → See No.10

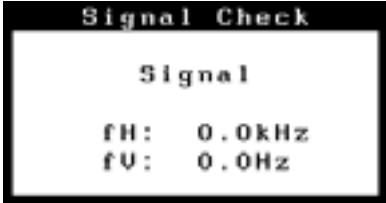
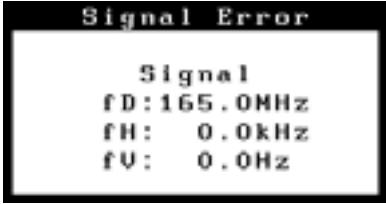
Problems	Points to check with possible solutions
<b>1. No picture</b> Indicator status: Off <hr/> Indicator status: Green Indicator status: Orange	<ul style="list-style-type: none"> <li>• Check that the power cord is connected correctly. If the problem persists, turn off the monitor power for a few minutes, then turn it back on and try again.</li> <li>• Try pressing a key on the keyboard or clicking the mouse (p.21).</li> <li>• Try turning the PC on.</li> </ul>
<b>2. One of the error messages shown below remains on the screen for 40 second.</b> <ul style="list-style-type: none"> <li>• The message appears when the signal is not input.</li> </ul>  <p>The image shows a black screen with white text. At the top, it says "Signal Check". Below that, it says "Signal". At the bottom, it displays "fH: 0.0kHz" and "fV: 0.0Hz".</p> <hr/> <ul style="list-style-type: none"> <li>• The message appears when the signal is out of input range. (Example)</li> </ul>  <p>The image shows a black screen with white text. At the top, it says "Signal Error". Below that, it says "Signal". At the bottom, it displays "fD: 165.0MHz", "fH: 0.0kHz", and "fV: 0.0Hz".</p>	<p>These messages appear when the signal is not inputted correctly, even if the monitor functions properly.</p> <ul style="list-style-type: none"> <li>• The message might appear because some PCs do not output the video signal immediately after powering on. If the image is displayed correctly after a short time, there is no problem with the monitor.</li> <li>• Check that the PC is turned on.</li> <li>• Check that the signal cable is properly connected to the PC or graphics board.</li> <li>• Reboot the PC.</li> <li>• Use the graphics board's utility software to change the frequency setting. (Refer to the manual of the graphics board.)</li> </ul>
<b>3. The screen is too bright or too dark.</b>	<ul style="list-style-type: none"> <li>• Adjust the &lt;Brightness&gt; (The LCD monitor backlight has a fixed life span. When the screen becomes dark or begins to flicker, please contact your dealer.)</li> </ul>
<b>4. Afterimages appear.</b>	<ul style="list-style-type: none"> <li>• Use a screen saver or off timer function for a long-time image display.</li> <li>• Afterimages are particular to LCD monitors. Avoid displaying the same image for a long time.</li> </ul>

## 7. Troubleshooting

Problems	Points to check with possible solutions
<b>5. The screen has defective pixels (e.g. slightly light or dark).</b>	<ul style="list-style-type: none"> <li>• This is due to LCD panel characteristics and is not a failure.</li> </ul>
<b>6. Interference patterns or pressure marks remain on the screen.</b>	<ul style="list-style-type: none"> <li>• Leave the monitor with a white or black screen. The symptom may disappear.</li> </ul>
<b>7. The ScreenManager main menu does not operate.</b>	<ul style="list-style-type: none"> <li>• Make sure that the adjustment lock is off (p. 24).</li> <li>• Make sure the control panel switches are not wet or soiled. Lightly wipe the surface of the control panel, and try touching the switches again with dry hands.</li> <li>• Make sure not to wear gloves. Remove any gloves, and try touching the switches again with dry hands.</li> </ul>
<b>8. The control panel does not operate. CAL Switch mode does not operate.</b>	<ul style="list-style-type: none"> <li>• Make sure the control panel switches are not wet or soiled. Lightly wipe the surface of the control panel, and try touching the switches again with dry hands.</li> <li>• Make sure not to wear gloves. Remove any gloves, and try touching the switches again with dry hands.</li> </ul>
<b>9. PC is hung up. / The peripherals connected to the downstream ports do not operate.</b>	<ul style="list-style-type: none"> <li>• Check that the USB cable is correctly connected.</li> <li>• Check the downstream ports by connecting the peripherals to other downstream ports. If the problem is solved by doing this, contact an EIZO dealer (For details, refer to the manual of the PC).</li> <li>• Try executing the following method.               <ul style="list-style-type: none"> <li>• Restarting the PC</li> <li>• Connecting the PC and peripherals directly</li> </ul> </li> </ul> <p>If the problem is solved by doing this, contact an EIZO dealer.</p>
<b>10. USB function cannot be setup.</b>	<ul style="list-style-type: none"> <li>• Check that the USB cable is correctly connected.</li> <li>• Check that the PC and OS are USB compliant. (For verification of USB support, consult the manufacturer of each system.)</li> <li>• Check the PC's BIOS setting for USB. (For details, refer to the manual of the PC.)</li> </ul>



---

## 8. Cleaning

Periodic cleaning is recommended to keep the monitor looking new and to prolong its operation lifetime.

---

### **NOTE**

- Never use thinner, benzene, alcohol, abrasive cleaners, or other strong solvents, as these may cause damage to the cabinet or LCD panel.
- 

### **Cabinet**

To remove stains, wipe the cabinet with a soft, lightly moistened cloth using a mild detergent. Do not spray wax or cleaner directly into the cabinet. (For details, refer to the manual of the PC.)

### **LCD Panel**

- The LCD surface can be cleaned with a soft cloth, such as cotton or lens paper.
- Remove persistent stains gently with a cloth dampened with little water, and then clean the LCD panel again with a dry cloth for better finishing.

---

### **Tips**

- Optional ScreenCleaner is recommended for cleaning the panel surface. ("ScreenCleaner" is supplied with GS520-BLG/GS520-CLG.)
-

# 9. Specifications

LCD Panel	GS520-BL GS520-CL	54cm(21.3 inch), TFT Monochrome LDC panel Surface treatment: Anti-Glare Hard Coating Surface hardness: 2H Response Time: 50ms
	GS520-BLG GS520-CLG	54cm(21.3 inch), TFT Monochrome LDC panel Surface treatment: Hard Coating Surface hardness: 3H Response Time: 50ms
Viewing Angle		Horizontal:170°, Vertical: 170° (CR 10 or more)
Dot Pitch		0.165mm
Horizontal Scan Frequency		31 ~ 135kHz
Vertical Scan Frequency		19 ~ 61Hz (VGA TEXT : 69 ~ 71Hz / QSXGA : 19 ~ 51Hz)
Resolution		5M pixels (Portrait: 2048 × 2560 dots (H × V))
Max.Dot Clock		300MHz
Gray Scale		4096 steps of 13771 steps (12 bit monochrome signal input)
Recommended Brightness		500 cd/m <sup>2</sup> (approx.80%)
Display Area(H × V)		422.4mm × 337.9mm (16.6"(H) × 13.3"(V))
Power Supply		100-120/200-240 VAC±10%, 50/60 Hz, 1.0-0.8A /0.5-0.4A
Power Consumption		Max.: 90W (With USB) Min.(Normal): 85W (Without USB) Power saving mode: Less than 1.2W (for single signal input without USB) Main power off: 0W
Input Connector		DVI-D x 1
Input Signal		TMDS(Single Link / Dual Link)
Plug & Play		VESA DDC 2B / EDID structure 1.3
Environment Conditions	Temperature	Operating: 0 °C ~ 35 °C (32 °F ~ 95 °F) Storage: -20 °C ~ 60 °C (-4 °F ~ 140 °F)
	Humidity	Operating:30 % to 80 % R.H. Non-condensing Storage: 30 % to 80 % R.H. Non-condensing
	Pressure	Operating: 700 to 1,060 hPa Storage: 200 to 1,060 hPa
USB	Standard	USB Specification Revision 2.0
	USB ports	Upstream port × 1, Downstream port × 2
	Communication Speed	480 Mbps (high), 12 Mbps (full), 1.5 Mbps (low)
	Power Supply	Downstream: 500 mA for each (Max.)
Classification of Equipment		Type of protection against electric shock : Class I EMC class : EN60601-1-2: 2001 Group 1 Class B Classification of medical device (MDD 93/42/EEC) : Class I
Dimensions	With stand	388mm (W) ×512.5 ~ 594.5mm (H) ×208.5m (D) (15.3"(W) × 20.2" ~ 23.4"(H) × 8.2"(D))
	Without stand	388mm (W) ×480mm (H) ×88mm (D) (15.3"(W) × 18.9" (H) × 3.46"(D))
Weight	With stand	9.6kg (21.2lbs.)
	Without stand	6.6kg (14.6lbs.)



## 9. Specifications

Network QC Management Software	EIZO "RadiNET Pro" Ver.3.0.2 or later
Cleaning Kit	EIZO "ScreenCleaner"
Signal Cable	DD200DL-BK

## Pin Assignment

### •DVI-D Connector

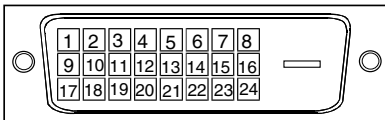

Pin No.	Signal	Pin No.	Signal	Pin No.	Signal
1	T.M.D.S. Data2-	9	T.M.D.S. Data1-	17	T.M.D.S. Data0-
2	T.M.D.S. Data2+	10	T.M.D.S. Data1+	18	T.M.D.S. Data0+
3	T.M.D.S. Data2/4 Shield	11	T.M.D.S. Data1/3 Shield	19	T.M.D.S. Data0/5 Shield
4	T.M.D.S. Data 4-	12	T.M.D.S. Data 3-	20	T.M.D.S. Data 5-
5	T.M.D.S. Data 4+	13	T.M.D.S. Data 3+	21	T.M.D.S. Data 5+
6	DDC Clock (SCL)	14	+5V Power	22	T.M.D.S. Clock shield
7	DDC Data (SDA)	15	Ground (return for +5V, Hsync, and Vsync)	23	T.M.D.S. Clock+
8	NC*	16	Hot Plug Detect	24	T.M.D.S. Clock-

(\*NC: No Connection)

### •USB Port

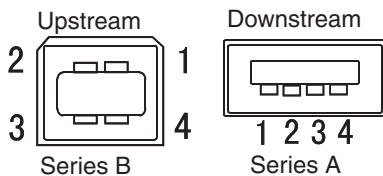

No.	Signal	Remarks
1	VCC	Cable power
2	- Data	Serial data
3	+ Data	Serial data
4	Ground	Cable Ground

---

# 10. Glossary

## **DICOM(Digital Imaging and Communication in Medicine)**

The DICOM standard was developed by the American College of Radiology and the National Electrical Manufacturer's Association of the USA.

The DICOM compatible device connection enables to transfer the medical image and information. The DICOM, Part 14 document defines the digital, grayscale medical image display.

## **DVI(Digital Visual Interface)**

A digital flat panel interface. DVI can transmit digital data from the PC directly without loss with the signal transition method "TMDS".

There are two kinds of DVI connectors. One is DVI-D connector for digital signal input only. The other is DVI-I connector for both digital and analog signal inputs.

## **DVI DMPM(DVI Digital Monitor Power Management)**

The Power management system for the digital interface. The "Monitor ON" status (operation mode) and the "Active Off" status (power-saving mode) are indispensable for the DVI-DMPM as the monitor's power mode.

## **Resolution**

The LCD panel consists of a fixed number of pixel elements which are illuminated to form the screen image. This monitor consists of 2048 horizontal pixels and 2560 vertical pixels. At a resolution of 2048 x 2560, all pixels are displayed as a full screen.

## **TMDS(Transition Minimized Differential Signaling)**

A signal transition method for the digital interface.

# EMC Information



**CAUTION**

The RadiForce series require special precautions regarding EMC and need to be installed, put into service and used according to the following information.

Do not use any cables other than the cables that provided or specified by us. Using other cables may cause the increase of emission or decrease of immunity.

Do not put any portable and mobile RF communications equipment close to the RadiForce series. Doing so may affect the RadiForce series.

The RadiForce series should not be used adjacent to or stacked with other equipment. If adjacent or stacked use is necessary, the equipment or system should be observed to verify normal operation in the configuration in which it will be used.

Guidance and manufacturer's declaration - electromagnetic emissions		
The RadiForce series are intended for use in the electromagnetic environment specified below. The customer or the user of the RadiForce series should assure that it is used in such an environment.		
Emission test	Compliance	Electromagnetic environment - guidance
RF emissions EN55011	Group 1	The RadiForce series use RF energy only for its internal function. Therefore, its RF emission are very low and are not likely to cause any interference in nearby electronic equipment.  The RadiForce series are suitable for use in all establishments, including domestic establishments and those directly connected to the public low-voltage power supply network that supplies buildings used for domestic purposes.
RF emissions EN55011	Class B	
Harmonic emissions EN61000-3-2	Class D	
Voltage fluctuations / flicker emissions EN61000-3-3	Complies	

Guidance and manufacturer's declaration - electromagnetic immunity			
The RadiForce series are intended for use in the electromagnetic environment specified below. The customer or the user of the RadiForce series should assure that it is used in such an environment.			
Immunity test	EN60601 test level	Compliance level	Electromagnetic environment - guidance
Electrostatic discharge (ESD) EN61000-4-2	±6kV contact ±8kV air	±6kV contact ±8kV air	Floors should be wood, concrete or ceramic tile. If floors are covered with synthetic material, the relative humidity should be at least 30%.
Electrical fast transient / burst EN61000-4-4	±2kV for power supply lines ±1kV for input/output lines	±2kV for power supply lines ±1kV for input/output lines	Mains power quality should be that of a typical commercial or hospital environment.
Surge EN61000-4-5	±1kV differential mode ±2kV common mode	±1kV differential mode ±2kV common mode	Mains power quality should be that of a typical commercial or hospital environment.
Voltage dips, short interruptions and voltage variations on power supply input lines EN61000-4-11	<5% U <sub>T</sub> , for 0.5 cycle (>95% dip in U <sub>T</sub> ) 40% U <sub>T</sub> , for 5 cycles (60% dip in U <sub>T</sub> ) 70% U <sub>T</sub> , for 25 cycles (30% dip in U <sub>T</sub> ) <5% U <sub>T</sub> , for 5s (>95% dip for U <sub>T</sub> )	<5% U <sub>T</sub> , for 0.5 cycle (>95% dip in U <sub>T</sub> ) 40% U <sub>T</sub> , for 5 cycles (60% dip in U <sub>T</sub> ) 70% U <sub>T</sub> , for 25 cycles (30% dip in U <sub>T</sub> ) <5% U <sub>T</sub> , for 5s (>95% dip for U <sub>T</sub> )	Mains power quality should be that of a typical commercial or hospital environment. If the user of the RadiForce series requires continued operation during power mains interruptions, it is recommended that RadiForce series be powered from an uninterruptible power supply or battery.
	Note: U <sub>T</sub> is the a.c. mains voltage prior to application of the test level.		
Power frequency (50/60Hz) magnetic field EN61000-4-8	3A/m	3A/m	The power frequency magnetic field should be measured in the intended installation location to assure that it is sufficiently low.

Immunity test	EN60601 test level	Compliance level	Electromagnetic environment - guidance
Conducted RF EN61000-4-6	3Vrms 150kHz to 80MHz	3Vrms 150kHz to 80MHz	Portable and mobile RF communications equipment should be used no closer to any part of the RadiForce series, including cables, than the recommended separation distance calculated from the equation applicable to the frequency of the transmitter.  Recommended Separation distance $d = 1.2 \sqrt{P}$
Radiated RF EN61000-4-3	3Vrms 80MHz to 2.5GHz	3Vrms 80MHz to 2.5GHz	$d = 1.2 \sqrt{P}$ , 80MHz to 800MHz $d = 2.3 \sqrt{P}$ , 800MHz to 2.5GHz  Where “P” is the maximum output power rating of the transmitter in watts (W) according to the transmitter manufacturer and “d” is the recommended separation distance in meters (m).  Field strengths from fixed RF transmitters, as determined by an electromagnetic site survey, should be less than the compliance level in each frequency range.  Interference may occur in the vicinity of equipment marked with the following symbol.

Recommended separation distance between portable and mobile RF communications equipment and the RadiForce series

The RadiForce series are intended for use in an electromagnetic environment in which radiated RF disturbances are controlled. The customer or the user of the RadiForce series can help prevent electromagnetic interference by maintaining a minimum distance between portable and mobile RF communications equipment (transmitters) and the RadiForce series as recommended below, according to the maximum output power of the communications equipment.

Rated maximum output power of transmitter  W	Separation distance according to frequency of transmitter m		
	150kHz to 80MHz $d = 1.2 \sqrt{P}$	80MHz to 800MHz $d = 1.2 \sqrt{P}$	800MHz to 2.5GHz $d = 2.3 \sqrt{P}$
0.01	0.12	0.12	0.23
0.1	0.38	0.38	0.73
1	1.2	1.2	2.3
10	3.8	3.8	7.3
100	12	12	23

For transmitters rated at a maximum output power not listed above, the recommended separation distance “d” in meters (m) can be estimated using the equation applicable to the frequency of the transmitter, where “P” is the maximum output power rating of the transmitter in watts (W) according to the transmitter manufacturer.

These guidelines may not apply in all situations. Electromagnetic propagation is affected by absorption and reflection from structures, objects and people.

Cable length		
Power Cord :	Accessory	2.0m
Signal Cable (FD-C39) :	Accessory	2.0m
USB Cable (MD-C93) :	Accessory	1.8m
Signal Cable (DD200DL) :	Option	2.0m

### **Hinweise zur Auswahl des richtigen Schwenkarms für Ihren Monitor**

Dieser Monitor ist für Bildschirmarbeitsplätze vorgesehen. Wenn nicht der zum Standardzubehör gehörige

Schwenkarm verwendet wird, muss statt dessen ein geeigneter anderer Schwenkarm installiert werden. Bei der

Auswahl des Schwenkarms sind die nachstehenden Hinweise zu berücksichtigen:

Der Standfuß muß den nachfolgenden Anforderungen entsprechen:

- a) Der Standfuß muß eine ausreichende mechanische Stabilität zur Aufnahme des Gewichtes vom Bildschirmgerät und des spezifizierten Zubehörs besitzen. Das Gewicht des Bildschirmgerätes und des Zubehörs sind in der zugehörigen Bedienungsanleitung angegeben.
- b) Die Befestigung des Standfußes muß derart erfolgen, daß die oberste Zeile der Bildschirmanzeige nicht höher als die Augenhöhe eines Benutzers in sitzender Position ist.
- c) Im Fall eines stehenden Benutzers muß die Befestigung des Bildschirmgerätes derart erfolgen, daß die Höhe der Bildschirmmitte über dem Boden zwischen 135 – 150 cm beträgt.
- d) Der Standfuß muß die Möglichkeit zur Neigung des Bildschirmgerätes besitzen (max. vorwärts:  $5^\circ$ , min. nach hinten  $\geq 5^\circ$ ).
- e) Der Standfuß muß die Möglichkeit zur Drehung des Bildschirmgerätes besitzen (max.  $\pm 180^\circ$ ). Der maximale Kraftaufwand dafür muß weniger als 100 N betragen.
- f) Der Standfuß muß in der Stellung verharren, in die er manuell bewegt wurde.
- g) Der Glanzgrad des Standfußes muß weniger als 20 Glanzeinheiten betragen (seidenmatt).
- h) Der Standfuß mit Bildschirmgerät muß bei einer Neigung von bis zu  $10^\circ$  aus der normalen aufrechten Position kippsicher sein.





#### **EIZO NANA O CORPORATION**

153 Shimokashiwano, Hakusan, Ishikawa 924-8566 Japan  
Phone: +81 76 277 6792 Fax: +81 76 277 6793

#### **EIZO NANA O TECHNOLOGIES INC.**

5710 Warland Drive, Cypress, CA 90630, U.S.A.  
Phone: +1 562 431 5011 Fax: +1 562 431 4811

#### **EIZO EUROPE AB**

Lovangsvagen 14 194 61, Upplands Väsby, Sweden  
Phone: +46 8 594 105 00 Fax: +46 8 590 91 575

#### **EIZO NANA O AG**

Moosacherstrasse 6, Au CH - 8820 Wädenswil, Switzerland  
Phone: +41-0-44 782 24 40 Fax: +41-0-44 782 24 50

#### **Avnet Technology Solutions GmbH**

Lötscher Weg 66, D-41334 Nettetal, Germany  
Phone: +49 2153 733-400 Fax: +49 2153 733-483

#### **株式会社ナナオ**

〒924-8566 石川県白山市下柏野町153番地

<http://www.radiforce.com>



This document is printed on recycled chlorine free paper.

1st Edition-January, 2008 Printed in Japan.

00NOL402A1  
(U.M-GS520)