

Sunbeam

Sunbeam MultiMincer®

Instruction and Recipe Booklet
FG5600

Please read these instructions carefully
and retain for future reference.



Contents

Sunbeam's Safety Precautions	3
Features of your Sunbeam MultiMincer®	4
Attachments for your Sunbeam MultiMincer®	6
Using your Sunbeam MultiMincer®	7
Storing your Sunbeam MultiMincer®	10
Handy Hints for Mincing	11
Handy Hints for Sausage Making	12
Care and Cleaning	13
Recipes	14

Important instructions – retain for future use.

تأكد من تفهم احتياطات السلامة المذكورة اعلاه

請務必理解上述的安全預防措施。

Assurez-vous que les précautions ci-dessus relatives à la sécurité sont bien comprises

Versichern Sie sich, dass die obenstehenden Sicherheitsmaßnahmen verstanden werden

Βεβαιώνετε πως οι παραπάνω προφυλάξεις ασφαλείας γίνονται κατανοητές

Pastikan bahwa tindakan-tindakan keselamatan seperti di atas dimengerti anda

Accertatevi che le suddette norme di sicurezza siano comprese a dovere

上記の注意事項をよくお読みになり、安全を御確認ください

Уверете се дека погоре споменатите мерки на претпазливост се добро разбрани

Asegúrese de que las precauciones de seguridad precedentes sean bien comprendidas

کاری بکنید کہ احتیاطهای بالا حتماً درک بشوند

ต้องแน่ใจว่า ข้อควรระวังเรื่องความปลอดภัยข้างต้น เป็นที่เข้าใจกันดี

Yukarda belirtilen güvenlik önlemlerinin anlaşılığundan emin olunuz

Xin kiểm chắc rằng những biện pháp làm an toàn kể trên được hiểu rõ

Sunbeam's Safety Precautions

SAFETY PRECAUTIONS FOR YOUR SUNBEAM MULTIMINCEUR.

- Always use extreme care when handling the blade and discs.
- Unplug from power outlet when not in use, before putting on or taking off attachments, and before cleaning.
- Only use the pusher that is supplied with this mincer.
- Do not put your fingers or any utensil into the feeder chute.

Sunbeam is very safety conscious when designing and manufacturing consumer products, but it is essential that the product user also exercise care when using an electrical appliance. Listed below are precautions which are essential for the safe use of an electrical appliance:

- Read carefully and save all the instructions provided with an appliance.
- Always turn the power off at the power outlet before you insert or remove a plug. Remove by grasping the plug - do not pull on the cord.
- Turn the power off and remove the plug when the appliance is not in use and before cleaning.
- Do not use your appliance with an extension cord unless this cord has been checked and tested by a qualified technician or service person.
- Always use your appliance from a power outlet of the voltage (A.C. only) marked on the appliance.
- This appliance is not intended for use by persons (including children) with reduced physical, sensory or mental capabilities, or lack of experience and knowledge, unless they have been given supervision or instruction concerning use of the appliance by a person responsible for their safety.
- Children should be supervised to ensure that they do not play with the appliance.
- The temperature of accessible surfaces may be high when the appliance is operating.
- Never leave an appliance unattended while in use.

- Do not contact moving parts at all times.
- Do not put hot meat into the mincer.
- All discs and attachments should be removed with care before cleaning.
- Only use the attachments and accessories provided and recommended by Sunbeam.
- Do not overload the mincer.
- Do not operate for more than 1 minute at a time while mincing heavy loads. This does not apply to any of the recipes in this booklet.

- Do not use an appliance for any purpose other than its intended use.
- Do not place an appliance on or near a hot gas flame, electric element or on a heated oven.
- Do not place on top of any other appliance.
- Do not let the power cord of an appliance hang over the edge of a table or bench top or touch any hot surface.
- Do not operate any electrical appliance with a damaged cord or after the appliance has been damaged in any manner. If damage is suspected, return the appliance to the nearest Sunbeam Appointed Service Centre for examination, repair or adjustment.
- For additional protection, Sunbeam recommend the use of a residual current device (RCD) with a tripping current not exceeding 30mA in the electrical circuit supplying power to your appliances.
- Do not immerse the appliance in water or any other liquid unless recommended.
- Appliances are not intended to be operated by means of an external timer or separate remote control system.
- This appliance is intended to be used in household and similar applications such as: staff kitchen areas in shops, offices and other working environments; farm houses; by clients in hotels, motels and other residential type environments; bed and breakfast type environments.

If you have any concerns regarding the performance and use of your appliance, please visit www.sunbeam.com.au or contact the Sunbeam Consumer Service Line.

Ensure the above safety precautions are understood.

Features of your Sunbeam MultiMincer[®]

Feeder tray

Use the Feeder Tray to hold food ready for mincing.

Mincer body

Houses the powerful 600 watt motor. (1500W Locked Rotar). Delivers high torque at low speeds to grind and mince through the toughest meat cuts.

Non-slip rubber feet

Makes the unit sturdy, preventing it from slipping or scratching the benchtop.

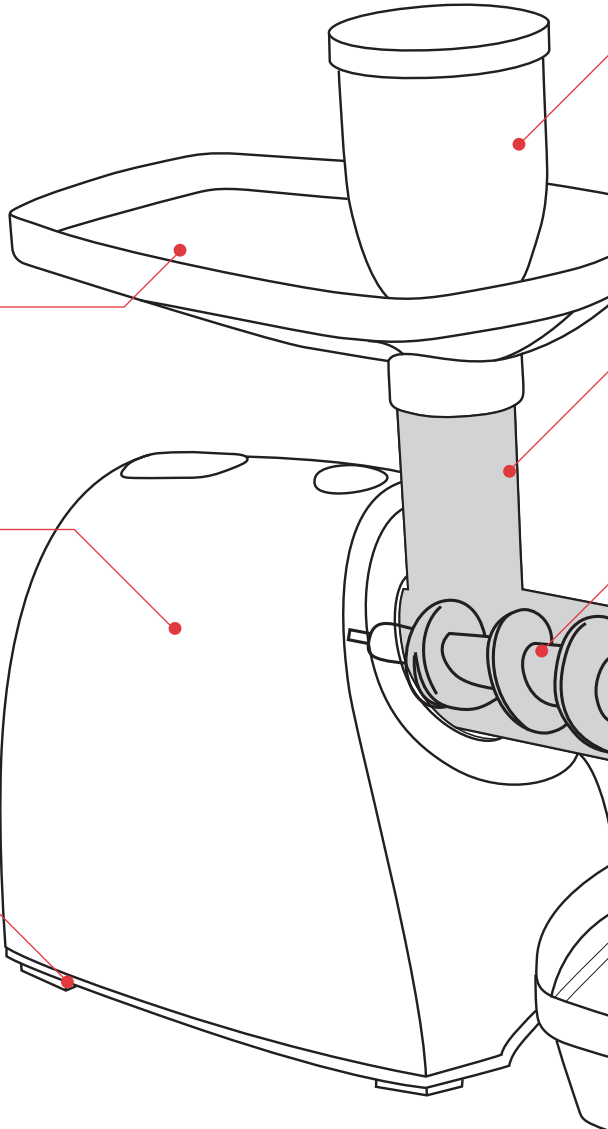

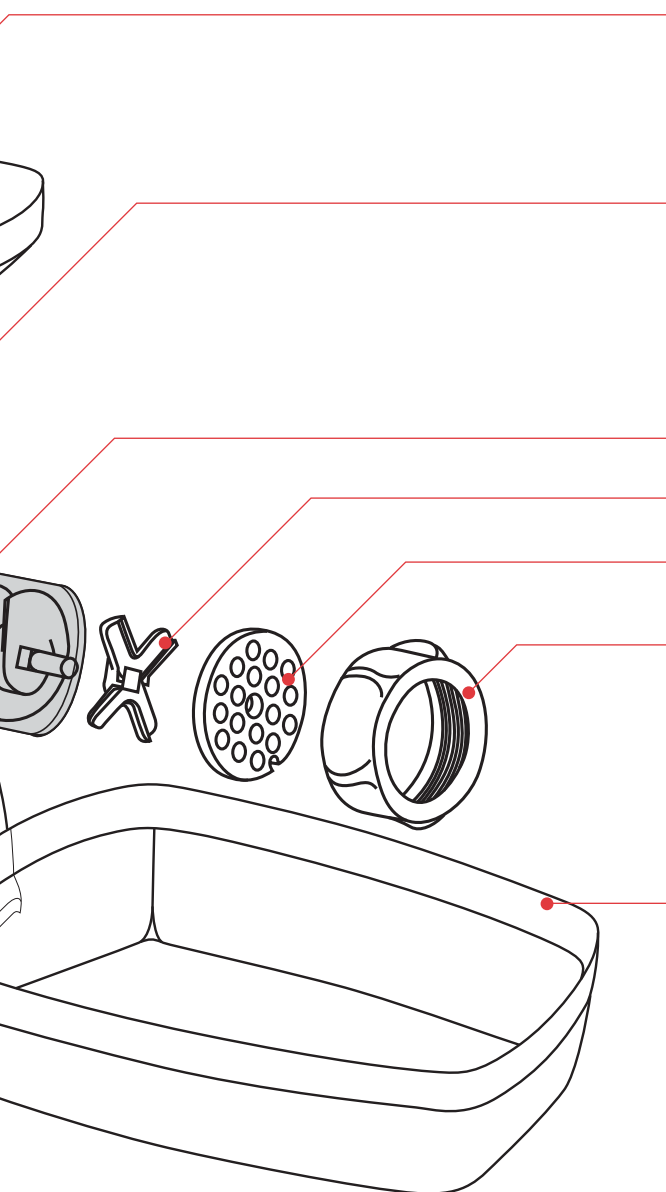

Food pusher

Guides meat safely through the chute to hit the mincing screw, for superior mincing results.

Chute

The chute houses the mincing screw and blade. Use the food pusher to direct food through the chute to the mincing screw and blade.

Mincing screw

Blade

Mincing discs

(Fine, Medium and Coarse)

Fastening dial

Locks the mincing discs, sausage and kebbe attachments firmly into place. Use the spanner to ensure it is firmly screwed onto the chute.

Food catcher

Place underneath chute for mince and sausage collection. Also doubles as a storage unit to store attachments – use the feeder tray as the lid.

Attachments for your Sunbeam MultiMincer®

Fine disc

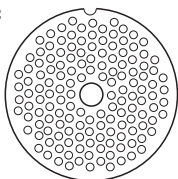

Medium disc

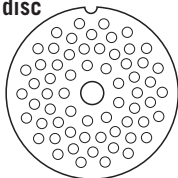

Coarse disc

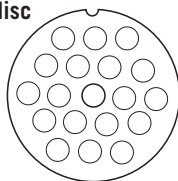

Cleaning disc

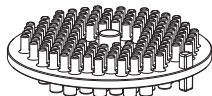

**Kebbe making attachments
(Kebbe cone, kebbe shaper)**

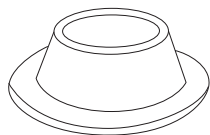
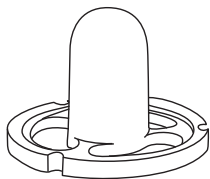

**Sausage making attachment
(Thick nozzle, thin nozzle, base plate)**

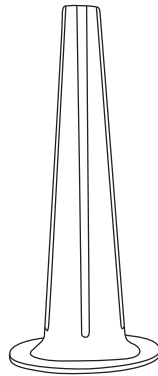
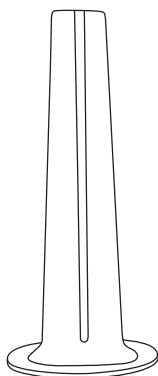
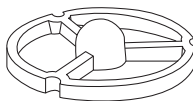

Feeder tray

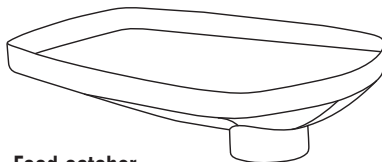

Food catcher

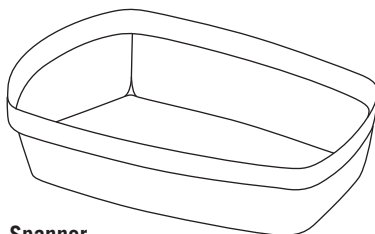

Spanner

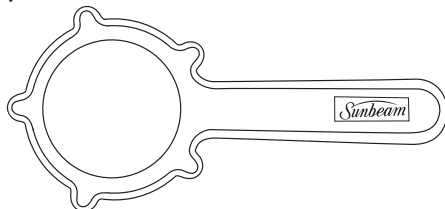

Using your Sunbeam MultiMincer[®]

Before using your Mincer

Wash all attachments in warm soapy water using a mild detergent. Dry each part thoroughly before use.

Before you assemble the mincer ensure that the power cord is unplugged.

NOTE: All attachments must be firmly in place before using the appliance. Ensure that the mincing screw and blade are firmly in place inside the mincer body and the mincer discs or sausage maker attachments are secured with the fastening dial.

Fitting and using the mincing discs

1. Place the mincer body, facing you on a level, dry surface.
2. Fit the mincing screw inside the chute.
3. Fit the blade over the mincing screw ensuring that the flat/smooth side of the blade faces the mincing screw, away from the mincing disc.
4. Fit the disc (depending on the type of mince you require, this will either be a fine, medium or coarse disc).
5. The fastening dial then fits over the disc and screws into place. Do not tighten this fastening dial yet as it will be harder to lock into the mincer body. See Fig 1.

Figure 1

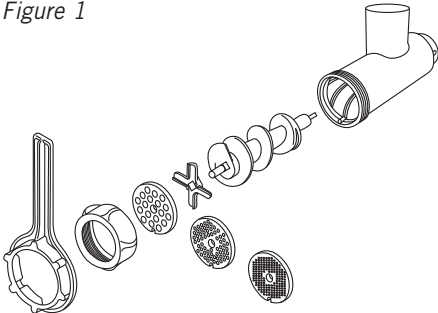

6. Align chute into the mincer body, using arrows as a guide. Press and hold the lock/unlock button to twist and lock into place.
7. Once the mincer body is in place, tighten the fastening dial using the spanner to ensure all elements are securely in place. See figure 2.
8. Place the food catcher underneath the fastening dial for mince collection and the feeder tray on top of the mincer chute. See figure 2.

Figure 2

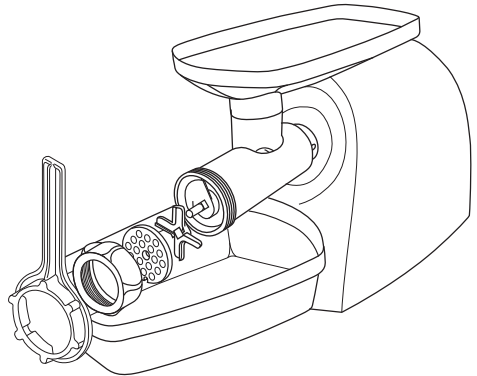

9. Place prepared meat in feeder tray. Plug the power cord into a 230-240V AC power outlet and turn the power 'ON'.
10. Switch the mincer on by pressing 'ON' button. Using the food pusher, gently push meat through the chute.

NOTE: Do not use excessive force to push meat through the mincing chute as it could damage the appliance.

CAUTION: Do not use anything else apart from the pusher supplied with this mincer to push meat through the chute. NEVER use your hands/fingers to push meat through the chute.

Using your Sunbeam MultiMincer® (continued)

Fitting and using the Kebbe attachments

1. Place the mincer body, facing you on a level, dry surface.
2. Fit the mincing screw inside the chute.
3. Fit the kebbe shaper.
4. Fit the kebbe cone over the shaper.
5. Secure the kebbe attachments with the fastening dial. Loosely secure with fastening dial – do not use spanner until chute is locked into mincer body. See figure 5.

Figure 5

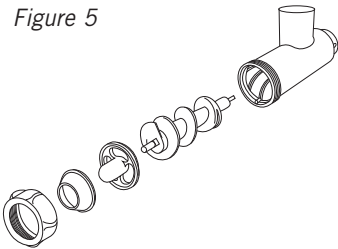

6. Align chute into the mincer body using arrows as a guide. Press and hold the lock/unlock button to twist and lock into place. Use the spanner to tighten the fastening dial to ensure all elements are securely in place.

7. Place the feeder tray on top of the chute. See Fig 6.

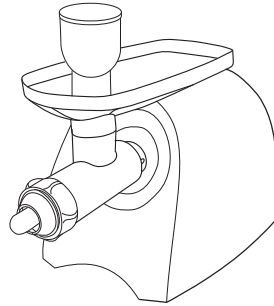

Figure 6

8. Plug the power cord into a 230-240V AC power outlet and turn the power 'ON'.
9. Switch on mincer.
10. Using the pusher, push the kebbe mixture into the chute.
11. Cut kebbe into desired lengths.

Tip: For full kebbe recipe and suggestions see page 20.

Storing your Sunbeam MultiMincer®

The Sunbeam MultiMincer® was designed so that all attachments can be stored in two unique storage components.

1. Attachments can be stored inside the food pusher as shown below:

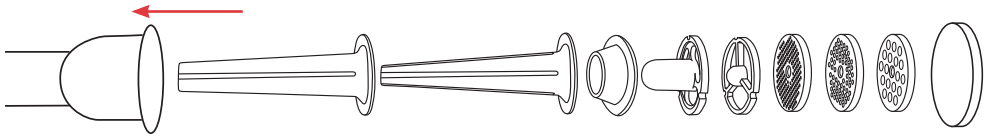

2. Storage of food pusher, cleaning disc spanner and food pusher in Food catcher / Feeder tray.

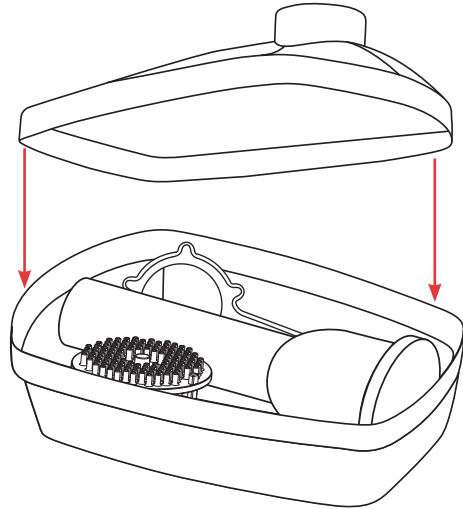

3. **Cord Storage:** The power cord can be stored by pushing it into the back of the motor base.

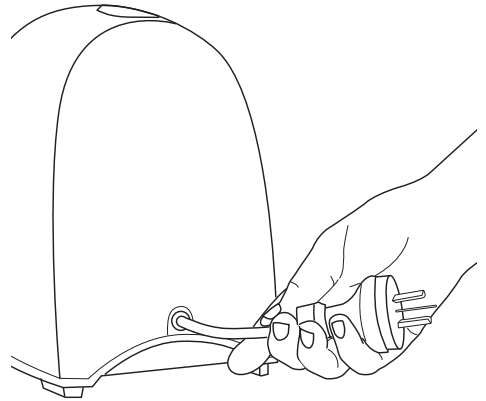

Handy Hints for Mincing

- Remove all large pieces of fat from meat before mincing.
- For fatty cuts of meat we recommend that you cut meat into 5cm cubes. For lean cuts of meat; cut into strips approximately 15cm long and 5cm thick or into cubes.
- Remove any bones from meat as this may damage the mincer.
- To make sure that all meat has come through mincing, place a 20cm sheet of crushed baking paper into the mincer after the last piece of meat. This will push through any remaining meat and will not damage the mincer.
- If changing mincing discs or changing to another attachment, always ensure that any meat that is around the fastening dial or blade is removed. This will ensure that all parts will reassemble and operate correctly.
- Minced meat should be used within 1-2 days. Freeze uncooked mince that will not be used within this time frame.
- Mince can be frozen for 2-3 months
- Thaw mince in refrigerator overnight, DO NOT refreeze uncooked meat.
- When cooking mince it needs to be cooked thoroughly. Mince that has been used for hamburgers or meat patties should be cooked until well done.

Handy Hints for Sausage Making

- Salt is an important component of sausage making. It is responsible for the control of growth of micro-organisms. It also aids in dissolving the myosin (protein) out of the muscle fibres which then acts as a glue to bind the meat together.
- Freshly made sausages are better when allowed to sit in the refrigerator for a minimum of 12 hours and for up to 24 hours.
- Fresh sausages are highly perishable products as they do not contain the preservatives that are present in most store-bought sausages. They should be cooked within 2-3 days of being made or frozen.
- Ideally, sausages should contain up to 30% fat content to provide a tender and moist product.
- Sausages should be thoroughly cooked to kill all microbes. Internal temperatures must reach 70-75°C.
- Intentional piercing of sausage skin releases much needed moisture but prevents the sausage from possibly splitting and being disfigured.
- Thing to look for when making sausages:
 - *Choose good quality ingredients*
 - *Fat to meat ratio (30:70)*
 - *Spices and seasoning should be combined in amounts that compliment the type of meat in the sausage.*
- Casings can be purchased from the butcher that have supplied you with your fresh meat. If preserved in salt, it should be soaked in lukewarm water for up to 30 minutes before use. Flush skins with cold water to expel excess salt.
- Unused fresh casings must be drained, covered with salt and frozen.
- Sausages should be stored in an air tight container or sealed with cling film in the refrigerator.
- A good way to make sure that all the sausage mince has come through the mincer is to break up 1-2 slices of bread and push through mincer, this will force any remaining mixture into the casing.
- Gentle cooking over medium heat prevents interior from boiling which in turn bursts the skin, leaking out moisture and flavour. This then produces a hard textured product.

Care and Cleaning

When you have completed mincing, unplug the mincer from the power outlet.

Ensure that all accessories and attachments are washed thoroughly with hot, soapy water.

To remove meat that is stuck in the fine and medium discs, align the holes of the mincing disc with the cleaning disc. Push the cleaning disc into the mincing disc. As shown in figure 1.

Any meat stuck in the mincing disc will be pushed out. Any remaining meat that is still in the mincing disc should be washed off using a soft sponge and hot soapy water.

To remove foods from the coarse disc, rinse disc under cold, running water to force meat from holes. Any remaining meat stuck on the mincing disc should be washed off using a soft sponge and hot soapy water.

Ensure that all attachments and discs are dried thoroughly before storing. If discs are not dried, rust may occur on the discs.

Tip: To store mincing discs, we recommend rubbing a little vegetable oil on the outside of the discs.

Warning: Take care in washing all attachment components to ensure that there is no food particles left in/around the mincing discs, sausage/kebbe making attachments, blade and mincing screw. We do not recommend dishwashing any of the mincing attachments.

Note: Always unplug the mincer to clean.

Do not wash/immerse the mincer body in water – clean this part only by wiping using a damp cloth.

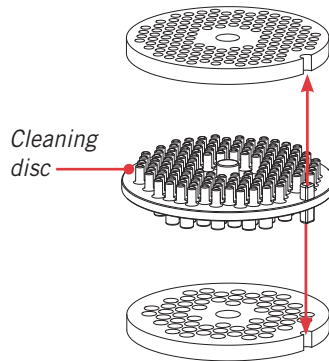

Figure 1

Recipes

Breakfast Sausages

Makes approx 1kg

700g pork neck, diced into 5cm pieces
400g chuck steak, diced into 5cm pieces
2 teaspoons onion powder
2 teaspoons salt
 $\frac{1}{4}$ teaspoon ground white pepper
2 tablespoons rice flour
 $\frac{1}{3}$ cup cold water

1. Assemble MultiMincer with the blade and medium disc.
2. Turn MultiMincer on and slowly add beef pieces into the chute using the food pusher.
3. Place mince into large bowl.
4. Whisk remaining ingredients until smooth; pour flour mixture over the beef and mix through thoroughly.
5. Remove blade and disk and attach base plate and the thin or thick sausage making attachment.
6. Thread sausage casing onto nozzle.

Tip: For thin sausages use a thin casing and the thin nozzle or for a thick sausage use a thick casing and the thick nozzle.

7. Turn Multimincer on and add the sausage mixture into the chute. Once the mixture starts to come through the nozzle, hold the casing at the tip of the nozzle to ensure that the mixture evenly comes through the casing.

Tip: The type of meat can be varied to your choice.

Italian Sausages

Makes approx 1kg

1.1kg pork neck, diced into 5cm pieces
2 tablespoons finely chopped parsley
1 clove garlic, crushed
2 tablespoons rice flour
2 teaspoons salt
1 teaspoon ground black pepper
 $\frac{1}{4}$ teaspoon cayenne pepper
 $\frac{1}{4}$ teaspoon chilli flakes
 $\frac{1}{3}$ cup red or white wine

1. Assemble MultiMincer with the blade and coarse disc.
2. Turn MultiMincer on and slowly add pork pieces into the chute using the food pusher.
3. In a large bowl, combine pork mince, parsley and garlic.
4. Whisk remaining ingredients until smooth; pour over the beef mix and stir through thoroughly.
5. Remove blade and disc and attach base plate and the thin or thick sausage making attachment.
6. Thread sausage casing onto nozzle.

Tip: For thin sausages use a thin casing and the thin nozzle or for a thick sausage use a thick casing and the thick nozzle.

7. Turn Multmincer on and add the sausage mixture into the chute. Once the mixture starts to come through the nozzle, hold the casing at the tip of the nozzle to ensure that the mixture comes through the casing evenly.

Recipes (continued)

Chicken, Spinach and Pine nut Sausages

Makes approx 1kg

- 1.1kg chicken thigh fillets, roughly chopped
- 1 cup firmly packed, finely chopped silverbeet – green part only
- $\frac{1}{3}$ cup toasted pine nuts
- $\frac{1}{2}$ teaspoon celery salt
- 1 teaspoon salt
- $\frac{1}{4}$ teaspoon ground white pepper
- 2 tablespoons rice flour
- $\frac{1}{3}$ cup cold water

1. Assemble MultiMincer with the blade and coarse disc.
2. Turn MultiMincer on and slowly add chicken pieces into the chute using the food pusher.
3. In a large bowl combine the chicken, silverbeet and nuts.
4. Whisk remaining ingredients until smooth; pour mixture over the chicken mix & stir through thoroughly.
5. Remove blade and disc and attach base plate and the thin or thick sausage making attachment.
6. Thread sausage casing onto nozzle.

Tip: For thin sausages use a thin casing and the thin nozzle or for a thick sausage use a thick casing and the thick nozzle.

7. Turn Multimincer on and add the sausage mixture into the chute. Once the mixture starts to come through the nozzle, hold the casing at the tip of the nozzle to ensure that the mixture evenly comes through the casing.

Merguez (North African Sausages)

Makes approx 1kg

- 1.1kg lamb shoulder, diced into 5cm cubes
- 1 tablespoon finely chopped mint leaves
- 2 cloves garlic, crushed
- 2 tablespoons rice flour
- 1 tablespoon sweet paprika
- 1 tablespoon ground cumin seed
- 2 teaspoons salt
- $\frac{1}{3}$ cup cold water

1. Assemble MultiMincer with the blade and coarse disc.
2. Turn MultiMincer on and slowly add lamb pieces into the chute using the food pusher.
3. In a large bowl combine the lamb mince, mint and garlic.
4. Whisk remaining ingredients until smooth; pour mixture over the beef mix & stir through thoroughly.
5. Remove blade and disc and attach base plate and the thin or thick sausage making attachment.
6. Thread sausage casing onto nozzle.

Tip: For thin sausages use a thin casing and the thin nozzle or for a thick sausage use a thick casing and the thick nozzle.

7. Turn MultiMincer on and add the sausage mixture into the chute. Once the mixture starts to come through the nozzle, hold the casing at the tip of the nozzle to ensure that the mixture comes through the casing evenly.

Recipes (continued)

Chicken, Lemon Pepper and Tarragon Sausages

Makes approx 1kg

- 1.1kg Chicken Thigh Fillets, roughly chopped
- 2 tablespoons coarsely chopped fresh tarragon
- ¼ teaspoon ground white pepper
- 2 teaspoons lemon pepper seasoning
- 1 teaspoon salt
- 2 tablespoons rice flour
- ⅓ cup cold water

1. Assemble MultiMincer with the blade and coarse disc.
2. Turn MultiMincer on and slowly add chicken pieces into the chute using the food pusher.
3. In a large bowl combine the chicken, tarragon, lemon and white pepper.
4. Whisk remaining ingredients until smooth; pour mixture over the chicken mix and stir through thoroughly.
5. Remove blade and disc and attach base plate and the thin or thick sausage making attachment.
6. Thread sausage casing onto nozzle.

Tip: For thin sausages use a thin casing and the thin nozzle or for a thick sausage use a thick casing and the thick nozzle.

7. Turn Multimincer on and add the sausage mixture into the chute. Once the mixture starts to come through the nozzle, hold the casing at the tip of the nozzle to ensure that the mixture evenly comes through the casing.

Sausage rolls

Makes 24

- 350g blade or chuck steak, diced into 5cm cubes
- 350g lamb shoulder, diced into 5cm cubes
- 1 tablespoon oil
- 1 onion, chopped finely
- 3 slices bread, crusts removed
- ¼ teaspoon dried oregano
- ¼ teaspoon dried basil
- 2 tablespoons chopped fresh parsley
- 2 teaspoons Worcestershire sauce
- Salt and pepper
- 3 sheets puff pastry
- 1 egg, beaten
- sesame seeds, optional

1. Assemble MultiMincer with the blade and fine disc.
2. Turn MultiMincer on and slowly add beef and lamb pieces into the chute using the food pusher.
3. Heat oil in a skillet and cook onions until translucent.
4. Place bread in a bowl of water and remove immediately. Gently squeeze out some of the water.
5. Combine the onions, bread, herbs, sauce, salt, pepper and mince. Mix until well combined.
6. Place sausage mince into a piping bag fitted with a wide round nozzle. Cut pastry in half and pipe a line of mince down the centre of each pastry half. Roll to enclose.
7. Cut pastry in 4 sausage rolls and place onto baking trays seam side down. Brush with egg and sprinkle with sesame seeds. Bake in hot oven for about 15- 20 minutes or until golden brown.

Tip: For a different flavour you can replace lamb with pork neck. For party size sausage rolls, simply cut into smaller rolls.

Recipes (continued)

Bolognaise

Serves 6

1kg topside steak, diced into 5cm cubes
2 tablespoons olive oil
1 medium onion, chopped finely
1 clove garlic, crushed
2 teaspoons dried basil
280g tomato paste
1 x 800g can peeled chopped tomatoes
2 cups water
Salt and pepper

1. Assemble MultiMincer with the blade and medium disc.
2. Turn MultiMincer on and slowly add beef pieces into the chute using the food pusher. Reserve and set aside.
3. Heat oil in a large pan over medium high heat, add onion and garlic and cook 2-3 minutes or until onion has softened.
4. Add dried basil and mince; cook, stirring frequently, for 4-5 minutes or until mince is brown and crumbly.
5. Stir in tomato paste and cook for 1 minute; add chopped tomatoes and water and bring to the boil. Reduce heat to medium, cover and simmer 20 minutes or until mixture has reduced and thickened.

Quick Lasagne

Serves 8-10

1 quantity bolognaise mixture
375g large instant lasagne sheets
500g blend grated mozzarella, cheddar and parmesan cheese
350g fresh ricotta

1. Preheat oven to 200°C
2. Lightly grease a 40cm x 22cm (approx) size deep baking dish. Spoon enough meat sauce on base to just cover. Place a layer of lasagne sheets to cover base.
3. Spoon about one third of the remaining meat sauce over the lasagne sheets to cover well. Sprinkle about one third of the blended cheese only over the meat. Place another layer of lasagne sheets on top.
4. Spoon another one third meat sauce over the lasagne sheets then spoon the fresh ricotta over the meat sauce. Top with more lasagne sheets. Repeat with the remaining meat sauce and another one third of the cheese. Top with the last layer of lasagne sheets and sprinkle with the remaining cheese.
5. Loosely cover lasagne with aluminium foil and bake for 40 minutes. Remove foil and bake, uncovered, for a further 20 minutes or until the top is golden and the lasagne sheets are cooked. To test, place a small sharp knife through the lasagne, if soft the sheets are cooked.

Recipes (continued)

Sang Choi Bow

Serves 4 as an entrée

You will need approximately 400g of chicken breast for this recipe. Pork can be substituted in this recipe. We recommend using the medium disc.

- 3 green onions
- 1 tablespoon peanut oil
- 1 clove garlic, crushed
- ½ teaspoon grated fresh ginger
- 6 fresh shitake mushrooms, chopped finely
- 350g chicken mince
- 4 lettuce leaves, to serve
- 2 teaspoons sesame seeds, toasted

Sauce

- 1 tablespoon shao hsing wine
- 1 tablespoon light soy sauce
- 1 tablespoon oyster sauce
- 1 tablespoon hoisin sauce
- 1 teaspoon sesame oil
- 1 teaspoon white sugar

1. Separate white and greens parts of onions. Finely chop the white parts and thinly slice the green. Keep separate and set aside.
2. Heat oil in a wok over high heat, add garlic, ginger, mushrooms and white parts of green onions and cook stirring frequently for 1 minute.
3. Add chicken mince and cook 3-4 minutes or until golden and crumbly.
4. Combine sauce ingredients in a separate bowl, mix well. Pour into chicken mince and stir-fry 3 minutes or until chicken mince is cooked and sauce has thickened. Stir through green parts of green onions.
5. Spoon into lettuce cups, sprinkle with sesame seeds and serve immediately.

Tip: Shoa Hsing wine, oyster sauce, hoisin sauce and sesame oil are all available in Asian supermarkets.

Red Curry Paste

Makes approx 1 cup

- 2 teaspoons shrimp paste
- 16 – 20 dried long red chillies
- 2 teaspoons salt
- 2 tablespoons chopped galangal
- 4 tablespoons chopped lemongrass
- 6 kaffir lime leaves, stems removed and sliced thinly
- 2 teaspoons scraped and chopped coriander root
- ¼ cup chopped red shallots
- ⅓ cup chopped fresh garlic

1. Preheat a grill on High. Wrap shrimp paste in aluminium foil and place onto a baking tray. Grill 1-2 minutes and turn over and repeat. Alternatively place onto a hot barbeque hot plate and cook 1-2 minutes each side. Remove and set aside to cool.
2. Remove stalks and seeds from chillies; place in a bowl. Pour over boiling water to cover and soak for 20 minutes or until softened. Drain chillies and roughly chop. Place chillies into a bowl with remaining ingredients; mix well.
3. Assemble MultiMincer with the blade and fine disc.
4. Turn MultiMincer on and slowly add paste ingredients into the chute using the food pusher. Repeat once or twice more depending on the fineness of paste you require.
5. Store paste in an airtight container for up to 3 days. Alternatively, freeze for up to 6 months.

Recipes (continued)

Thai Chicken Red Curry

Serves 4

1 tablespoon vegetable oil
1 onion, cut into thin wedges
1 portion home made red curry paste
1 x 400ml can coconut milk
2 teaspoons sugar
1 tablespoon fish sauce
750g chicken breast fillet, sliced thinly
1 red capsicum, deseeded and sliced
230g can bamboo shoots, drained
100g sugar snap peas
Coriander leaves, to serve

1. Heat oil in a wok over high heat, add onion and cook 1-2 minutes, stirring frequently or until softened.
2. Add red curry paste and cook 1 minute. Reduce heat to medium and stir in coconut milk, sugar and fish sauce.
3. Add chicken and capsicum and simmer for about 3 minutes or until chicken is just cooked. Stir through bamboo shoots and sugar snap peas and simmer a further 1-2 minutes.
4. Serve hot with steamed jasmine rice and fresh coriander leaves.

Tip: If using store bought curry paste use 2-3 tablespoons to taste.

Matt's Meatballs

Serves 6-8

1.3kg lean beef
 $\frac{2}{3}$ cup packaged breadcrumbs
3 eggs
2 tablespoons Worcestershire sauce
2 teaspoons dried sweet basil
1 teaspoon dried oregano
2 cloves garlic, crushed
salt and pepper
2 tablespoons olive oil

Sauce

- 1 onion, sliced
2 cloves garlic, crushed
2 tablespoons tomato paste
1 green capsicum, sliced
1 red capsicum, sliced
1 litre bottled tomato sauce
1. Assemble MultiMincer with the blade and fine disc.
 2. Turn MultiMincer on and slowly add beef pieces into the chute using the food pusher.
 3. Combine meatball ingredients; roll into balls slightly smaller than golf balls.
 4. Heat half of the oil in a frying pan over a medium heat. Cook meatballs, in batches, until browned all over. Remove from pan.
 5. Heat remaining oil in frying pan; cook onions and garlic, stirring, until the onions are translucent. Add tomato paste and cook for about 1-2 minutes or until fragrant. Add capsicums; cook, stirring occasionally, until tender. Add sauce and cook for 10 minutes. Reduce heat; add meatballs and cook, covered, for a further 10 minutes or until the meatballs are cooked through.
 6. Serve in long crusty bread rolls as a sub sandwich or with pasta.

Recipes (continued)

Kebbe

Outer casing

- 500g fine cracked wheat (burghul)
- 500g lean lamb loin, cubed
- 1 small onion, roughly chopped
- 1 teaspoon ground black pepper
- 1 teaspoon ground white pepper
- 1 tablespoon sea salt

Filling

- 350g lamb leg steak, cubed
- 20g butter
- 25g pinenuts
- 1 medium onion, chopped finely
- 2 tablespoons chopped fresh mint
- ¼ teaspoon ground black pepper
- ¼ teaspoon ground white pepper
- 1 teaspoon sea salt

OUTER CASING

1. Place cracked wheat in a large bowl and cover with cold water. Allow to soak for minimum of 30 minutes, drain and reserve.
2. Assemble MultiMincer with the blade and fine disc.
3. Turn MultiMincer on and mince lamb; add the onion before the last batch.
4. In a large bowl combine the meat with the cracked wheat, pepper and salt. Mix by hand until thoroughly combined.
5. Remove fine mincing disc and blade and insert medium disc without blade. Place lamb and cracked wheat mixture through mincer. Refrigerate for 1 hour.

FILLING

1. Assemble MultiMincer with the blade and medium disc.
2. Turn MultiMincer on and slowly add lamb pieces into the chute using the food pusher.
3. Heat butter in a large frying pan over medium heat. Add pine nuts and cook 2-3 minutes or until golden. Remove and set aside.
4. Fry onion in same pan until golden.
5. Add lamb mince and cook for 5-6 minutes or until browned (do not overcook). Season with salt and pepper. Stir through mint and pine nuts. Allow to cool completely.

TO ASSEMBLE

1. Assemble MultiMincer with the kebbe making attachments.
2. Turn MultiMincer on and push the casing mixture through the chute using the food pusher.
3. Cut into 8cm (3 inch) lengths.
4. Pinch one end of the tube to seal it. Spoon a little filling, into the other end, then seal.
5. Deep fry in hot oil for about 6 minutes or until golden brown.

Tip: Kebbe can be frozen. Kebbe can be cooked fresh or straight from the freezer. This will take approximately 3-4 minutes fresh, or 4-6 minutes from frozen. Please be careful when frying as oil may spatter.

Notes

Notes

12 Month Replacement Guarantee

In the unlikely event that this appliance develops any malfunction within 12 months of purchase (3 months commercial use) due to faulty materials or manufacture, we will replace it for you free of charge.

Should you experience any difficulties with your appliance, please phone our customer service line for advice on 1300 881 861 in Australia, or 0800 786 232 in New Zealand. Alternatively, you can send a written claim to Sunbeam at the address listed below. On receipt of your claim, Sunbeam will seek to resolve your difficulties or, if the appliance is defective, advise you on how to obtain a replacement or refund.

Your Sunbeam 12 Month Replacement Guarantee naturally does not cover misuse or negligent handling and normal wear and tear.

Similarly your 12 Month Replacement Guarantee does not cover freight or any other costs incurred in making a claim. Please retain your receipt as proof of purchase.

The benefits given to you by this guarantee are in addition to your other rights and remedies under any laws which relate to the appliance.

Our goods come with guarantees that cannot be excluded under the Australian Consumer Law and under the New Zealand Consumer Guarantees Act.

In Australia you are entitled to a replacement or refund for a major failure and for compensation for any other reasonably foreseeable loss or damage. You are also entitled to have the goods repaired or replaced if the goods fail to be of acceptable quality and the failure does not amount to a major failure.

Should your appliance require repair or service after the guarantee period, contact your nearest Sunbeam service centre.

For a complete list of Sunbeam's authorised service centres visit our website or call:

Australia

www.sunbeam.com.au

1300 881 861

Units 5 & 6, 13 Lord Street
Botany NSW 2019 Australia

New Zealand

www.sunbeam.co.nz

0800 786 232

26 Vestey Drive, Mt Wellington
Auckland, New Zealand

Need help with your appliance?

Contact our customer service team or visit our website for information and tips on getting the most from your appliance.

In Australia

Visit www.sunbeam.com.au

Or call 1300 881 861

In New Zealand

Visit www.sunbeam.co.nz

Or call 0800 786 232

 is a registered trademark.

'Sunbeam MultiMincer' is a registered trademark of Sunbeam Corporation.

Made in China.

Due to minor changes in design or otherwise, the product may differ from the one shown in this leaflet.

© Copyright. Sunbeam Corporation Limited 2011.

ABN 45 000 006 771

Units 5 & 6, 13 Lord Street
Botany NSW 2019 Australia

Unit 3, Building D
26 Vestey Drive
Mt Wellington Auckland
New Zealand

Sunbeam Corporation is a division of GUD Holdings Ltd.