



# LC-13SH1E LC-15SH1E LC-20SH1E

## LCD COLOUR TELEVISION ENGLISH

### OPERATION MANUAL

## Contents

<b>Dear SHARP Customer .....</b>	<b>2</b>	<b>Useful Features .....</b>	<b>14</b>
<b>Important Safety Precautions .....</b>	<b>2</b>	Picture Adjustments .....	14
<b>Supplied Accessories .....</b>	<b>4</b>	Sound Adjustments .....	14
<b>Preparation .....</b>	<b>4</b>	Sound Mode Settings .....	15
Installing Batteries in the Remote Control .....	4	Programmes .....	16
Using the Remote Control .....	4	Using the Programme Table .....	18
Power Connection .....	5	Rotate .....	18
Antenna Connection .....	5	EXT Connections .....	19
Listening with Headphones .....	5	Clock Setup .....	20
First Installation .....	6	Language .....	20
<b>Part Names of the Main Unit .....</b>	<b>7</b>	Teletext Language .....	20
How to Fix the Cables .....	8	Backlight .....	21
How to Prevent the LCD TV Set from Falling Over .....	8	Sleep Timer .....	21
<b>Part Names of the Remote Control .....</b>	<b>9</b>	Auto Power Off .....	21
<b>Basic Operation .....</b>	<b>10</b>	On-Screen Display .....	22
Turning On and Off the Main Power .....	10	Child Lock .....	22
STANDBY/ON .....	10	NICAM Broadcast Selection .....	24
Switching the Input Mode (EXT1/EXT2/TV) .....	10	A2 Stereo Broadcast Selection .....	24
Sound Volume .....	11	<b>Teletext .....</b>	<b>25</b>
Changing Channels .....	11	<b>Connecting External Devices .....</b>	<b>27</b>
Selecting Menu Items .....	12	Example of external devices that can be connected .....	27
		Connecting to the EXT1/EXT2 Terminals .....	28
		<b>Troubleshooting .....</b>	<b>29</b>
		LCD TV set .....	29
		Antenna .....	30
		<b>Specifications .....</b>	<b>30</b>

#### Dimensional Drawings

- The dimensional drawings for each model are shown on the inside back cover.



## Dear SHARP Customer

---

Thank you for your purchase of the SHARP LCD colour TV product. To ensure safety and many years of trouble-free operation of your product, please read the Important Safety Precautions carefully before using this product.

### Important Safety Precautions

---

Electricity is used to perform many useful functions, but it can also cause personal injuries and property damage if improperly handled. This product has been engineered and manufactured with the highest priority on safety. However, improper use can result in electric shock and/or fire. In order to prevent potential danger, please observe the following instructions when installing, operating and cleaning the product. To ensure your safety and prolong the service life of your LCD colour TV product, please read the following precautions carefully before using the product.

1. Read instructions—All operating instructions must be read and understood before the product is operated.
2. Keep this manual in a safe place—These safety and operating instructions must be kept in a safe place for future reference.
3. Observe warnings—All warnings on the product and in the instructions must be observed closely.
4. Follow instructions—All operating instructions must be followed.
5. Attachments—Do not use attachments not recommended by the manufacturer. Use of inadequate attachments can result in accidents.
6. Power source—This product must operate on a power source specified on the specification label. If you are not sure of the type of power supply used in your home, consult your dealer or local power company.
7. AC cord protection—The AC cords must be routed properly to prevent people from stepping on them or objects from resting on them. Check the cords at the plugs and product.
8. Overloading—Do not overload AC outlets or extension cords. Overloading can cause fire or electric shock.
9. Entering of objects and liquids—Never insert an object into the product through vents or openings. High voltage flows in the product, and inserting an object can cause electric shock and/or short internal parts. For the same reason, do not spill water or liquid on the product.
10. Servicing—Do not attempt to service the product yourself. Removing covers can expose you to high voltage and other dangerous conditions. Request a qualified service person to perform servicing.
11. Repair—If any of the following conditions occurs, unplug the AC cord from the AC outlet, and request a qualified service person to perform repairs.
  - a. When the AC cord or plug is damaged.
  - b. When a liquid was spilled on the product or when objects have fallen into the product.
  - c. When the product has been exposed to rain or water.
  - d. When the product does not operate properly as described in the operating instructions.  
Do not touch the controls other than those described in the operating instructions. Improper adjustment of controls not described in the instructions can cause damage, which often requires extensive adjustment work by a qualified technician.
  - e. When the product has been dropped or damaged.
  - f. When the product displays an abnormal condition. Any noticeable abnormality in the product indicates that the product needs servicing.
12. Replacement parts—In case the product needs replacement parts, make sure that the service person uses replacement parts specified by the manufacturer, or those with the same characteristics and performance as the original parts. Use of unauthorised parts can result in fire, electric shock and/or other danger.
13. Safety checks—Upon completion of service or repair work, request the service technician to perform safety checks to ensure that the product is in proper operating condition.
14. Wall or ceiling mounting—When mounting the product on a wall or ceiling, be sure to install the product according to the method recommended by the manufacturer.



## Important Safety Precautions (Continued)

- **Cleaning**—Unplug the AC cord from the AC outlet before cleaning the product. Use a damp cloth to clean the product. Do not use liquid cleaners or aerosol cleaners.

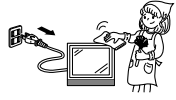

- The LCD panel used in this product is made of glass. Therefore, it can break when the product is dropped or applied with impact. Be careful not to be injured by broken glass pieces in case the LCD panel breaks.

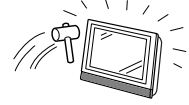

- **Water and moisture**—Do not use the product near water, such as bathtub, washbasin, kitchen sink, laundry tub, swimming pool and in a wet basement.



- **Heat sources**—Keep the product away from heat sources such as radiators, heaters, stoves and other heat-generating products (including amplifiers).



- **Stand**—Do not place the product on an unstable cart, stand, tripod or table. Doing so can cause the product to fall, resulting in serious personal injuries as well as damage to the product. Use only a cart, stand, tripod, bracket or table recommended by the manufacturer or sold with the product. When mounting the product on a wall, be sure to follow the manufacturer's instructions. Use only the mounting hardware recommended by the manufacturer.



- Do not place vases or any other water-filled containers on this product. The water may spill onto the product causing fire or electric shock.

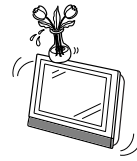

- To prevent fire, never place any type of candle or naked flames on the top or near the TV set.

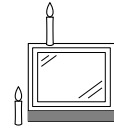

- When relocating the product placed on a cart, it must be moved with utmost care. Sudden stops, excessive force and uneven floor surface can cause the product to fall from the cart.



- To prevent fire or shock hazard, do not place the AC power cord under the TV set or other heavy items.

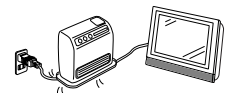

- **Ventilation**—The vents and other openings in the cabinet are designed for ventilation. Do not cover or block these vents and openings since insufficient ventilation can cause overheating and/or shorten the life of the product. Do not place the product on a bed, sofa, rug or other similar surface, since they can block ventilation openings. This product is not designed for built-in installation; do not place the product in an enclosed place such as a bookcase or rack, unless proper ventilation is provided or the manufacturer's instructions are followed.



The LCD panel is a very high technology product with 921,600 thin film transistors, giving you fine picture details. Due to the very large number of pixels, a few non-active pixels may occasionally appear on the screen as a fixed point of blue, green or red. This is within product specifications and does not constitute a fault.

Do not display a still picture for a long time, as this could cause an afterimage to remain.

# Supplied Accessories

Make sure the following accessories are provided with the LCD TV set.

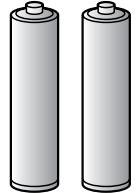
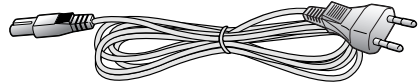
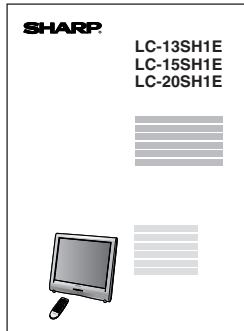
Wireless remote control	"AA" size batteries (x2)	AC cord	Operation manual
 <p>pages 4 and 9</p>	 <p>page 4</p>	 <p>*Product shape may vary from country to country. page 5</p>	

# Preparation

## Installing Batteries in the Remote Control

Before using the LCD TV set for the first time, install the two "AA" size batteries (supplied) in the remote control. When the batteries become depleted and the remote control fails to operate, replace the batteries with new "AA" size batteries.

- 1** Open the battery cover.    **2** Insert two "AA" size batteries.    **3** Close the battery cover.

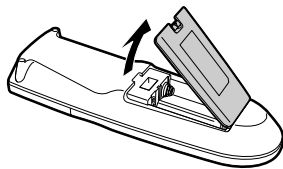

- Detach the cover while pressing the (▼) part.

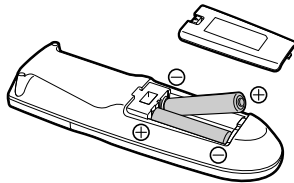

- Place batteries with their terminals corresponding to the (+) and (-) indications in the battery compartment.

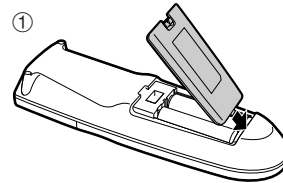

- Align the tab on the battery cover (①) and place it while pressing the tab (②) to close it.

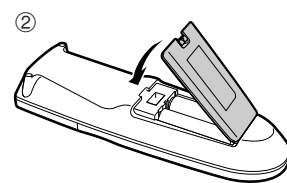

### ⚠ Caution!

#### Precautions regarding batteries

Improper use of batteries can result in a leakage of chemicals and/or explosion. Be sure to follow the instructions below.

- Place batteries with their terminals corresponding to the (+) and (-) indications.
- Different types of batteries have different characteristics. Do not mix batteries of different types.
- Do not mix old and new batteries. Mixing old and new batteries can shorten the life of new batteries and/or cause old batteries to leak chemicals.
- Remove batteries as soon as they are depleted. Chemicals that leak from batteries can cause a rash. If chemical leakage is found, wipe it off with a cloth.
- The batteries supplied with the LCD TV set may have a shorter operating time due to storage conditions.
- If the remote control is not to be used for an extended period of time, remove the batteries from the remote control.

## Using the Remote Control

Use the remote control by pointing it towards the remote sensor window of the main unit. Objects between the remote control and sensor window may prevent proper operation.

#### Cautions regarding use of the remote control

- Do not apply shock to the remote control. In addition, do not expose the remote control to liquids, and do not place it in an area with high humidity.
- Do not install or place the remote control under direct sunlight. The heat may cause deformation of the unit.
- The remote control may not work properly if the remote sensor window is under direct sunlight or strong lighting. In such a case, change the angle of the lighting or main unit, or operate the remote control closer to the remote sensor window.

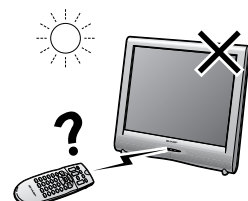
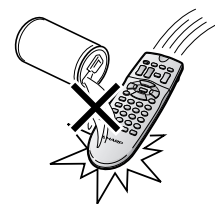
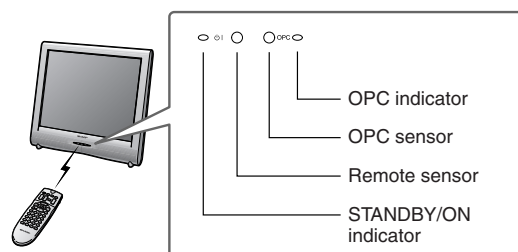



## Preparation (Continued)

### Power Connection

Connect to the AC input terminal of the LCD TV set using the AC cord (supplied).

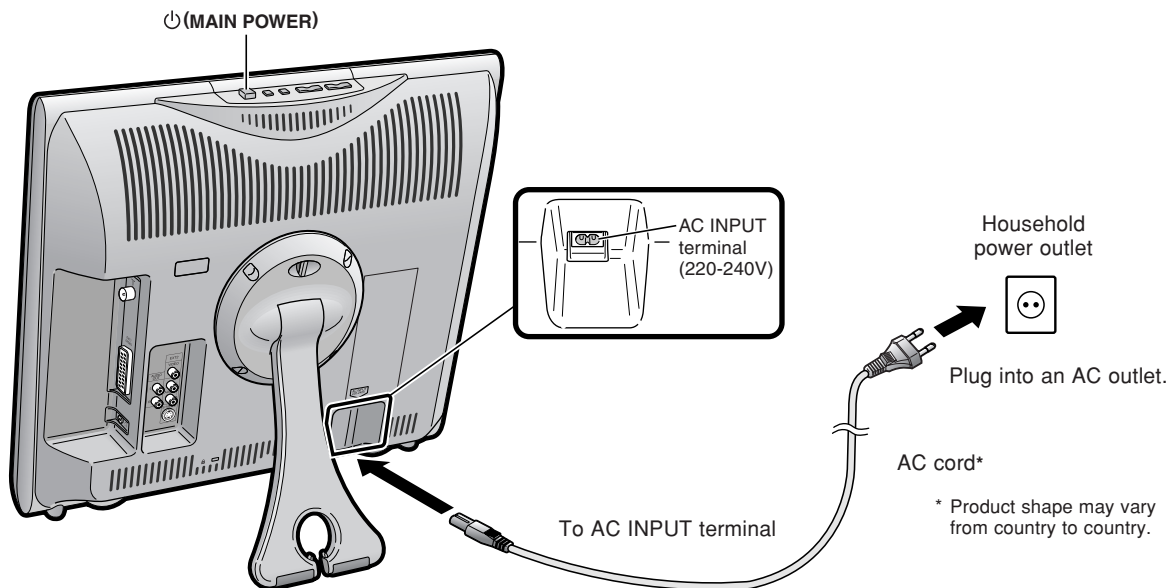

#### NOTE

- Always turn the ⏻ (MAIN POWER) switch of the LCD TV set to OFF when connecting the AC cord.
- Unplug the AC cord from the LCD TV set and power outlet when the LCD TV set is not to be used for a long period of time.

### Antenna Connection

#### ■ Using a TV antenna cable

To enjoy a clearer picture, we recommend that you use an outdoor antenna. The following is a brief explanation of the type of connection that is used for coaxial cable:

- Please ensure your 75-ohm coaxial cable is fitted with a DIN 45325 (IEC169-2) coaxial plug and plug it into the antenna terminal at the side of the LCD TV set (antenna cable not supplied).

75-ohm coaxial cable (round cable)

To antenna terminal (T)

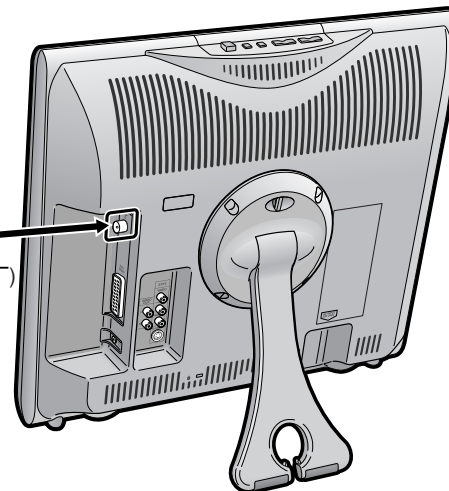

### Listening with Headphones

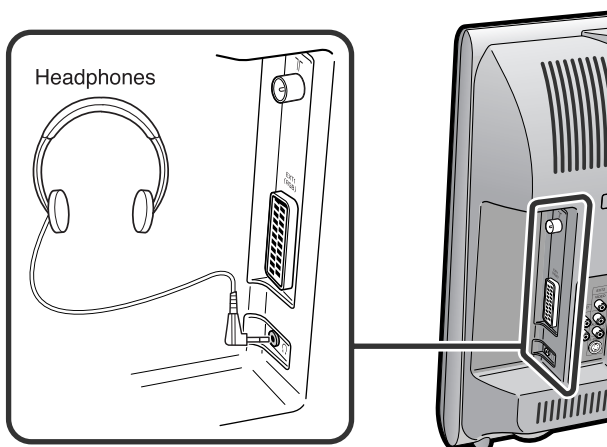

Plug the headphone mini-plug into the headphone jack located on the side of the LCD TV set.  
Adjust the sound volume using (-)/(+) on the remote control.

#### On-screen display

TV Volume  
10

#### NOTE

- Headphones are not included in the supplied accessories.
- No sound is heard from the main unit speakers when a headphone mini-plug is connected into the headphone jack.
- Do not set the volume at a high level. Hearing experts advise against extended listening at high volume levels.



## Preparation (Continued)

### First Installation

When you turn on the LCD TV set for the first time, the First Installation routine, which makes installation easier, is activated. Using this routine, you can select the on-screen display language, clock setup and automatically search for and store all the receivable TV channels.

#### NOTE

- You can also execute the First Installation routine by selecting "First installation" on the Setup Menu screen. For selecting the menu items, see pages 12 and 13.

Control panel of the main unit

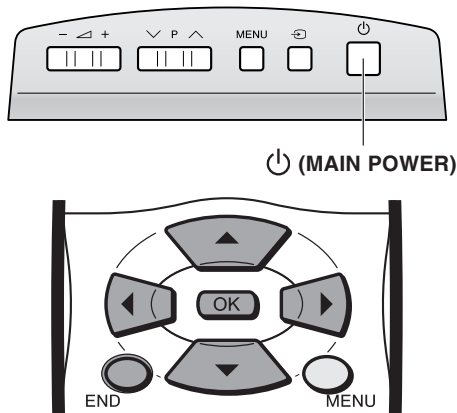

- Press **⏻ (MAIN POWER)** on the LCD TV set.
  - The "First installation" screen with a list of the languages for the on-screen display is displayed.
- Press **▲/▼/◀/▶** to select the desired language, and press **OK**.



- Press **▲/▼** to set the time, and press **OK**.
  - The time you set is automatically updated via Teletext time information.



- Press **▲/▼** to select the desired item, and press **◀/▶** to make the setting.

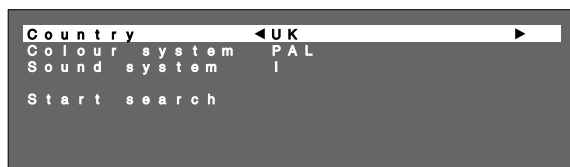

- Press **▲/▼** to select "Start search", and press **OK**.

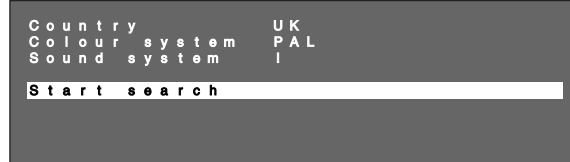

- The automatic programme search begins.

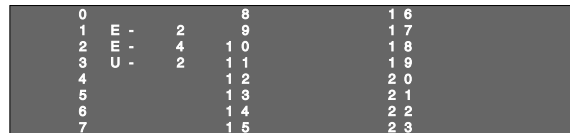

- Press **END** to exit.

#### NOTE

- After the First installation routine, you can change the settings of "Language" (page 20) and "Clock setup" (page 20), and perform "Automatic search" (page 16) again.

## Part Names of the Main Unit

The examples used throughout this manual are based on the LC-20SH1E model.

### Controls

#### Upper control panel

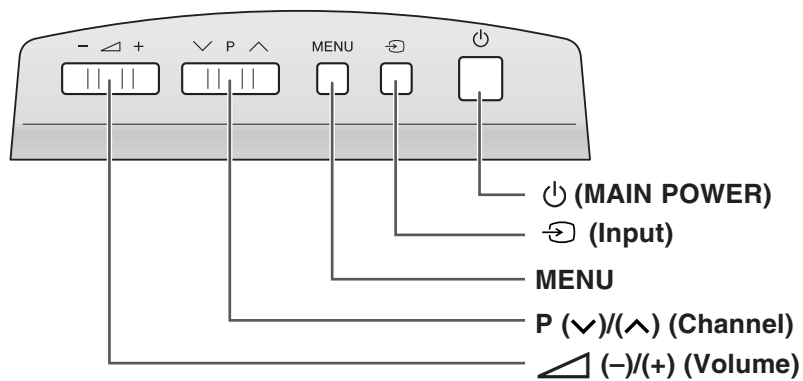

### How to adjust the angle

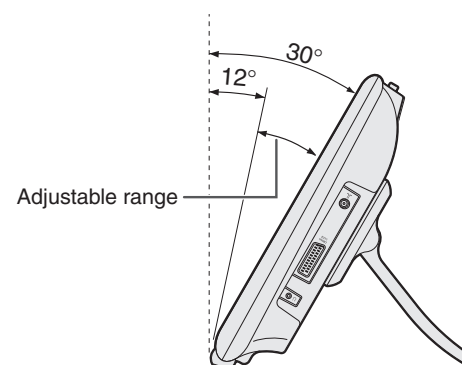

The screen angle can be tilted backwards between 12 and 30 degrees. (It cannot be set to vertical.) When changing the angle, make sure to hold the stand and adjust the screen to the best viewable angle.

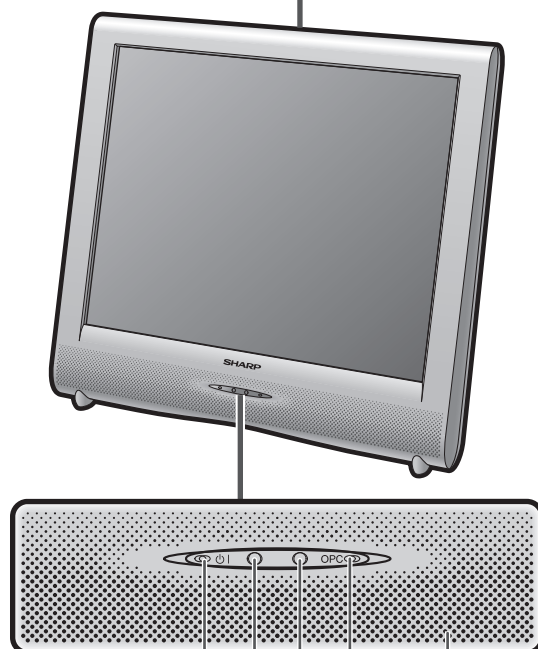

Speaker

OPC (Optical Picture Control) indicator

The OPC indicator lights up green when the "Backlight" is set to "Auto (OPC)". (See page 21.)

OPC sensor

Remote sensor

#### STANDBY/ON indicator

STANDBY/ON indicator lights up green when the power is on, and red when in the standby mode (the indicator will not light when the main power is off).

#### NOTE

- (Input), P (Channel), (-)/(+) (Volume) and MENU on the control panel of the main unit have the same functions as the same buttons on the remote control (see page 12). Fundamentally, this operation manual provides a description based on operation using the remote control.



## Part Names of the Main Unit (Continued)

### Terminals

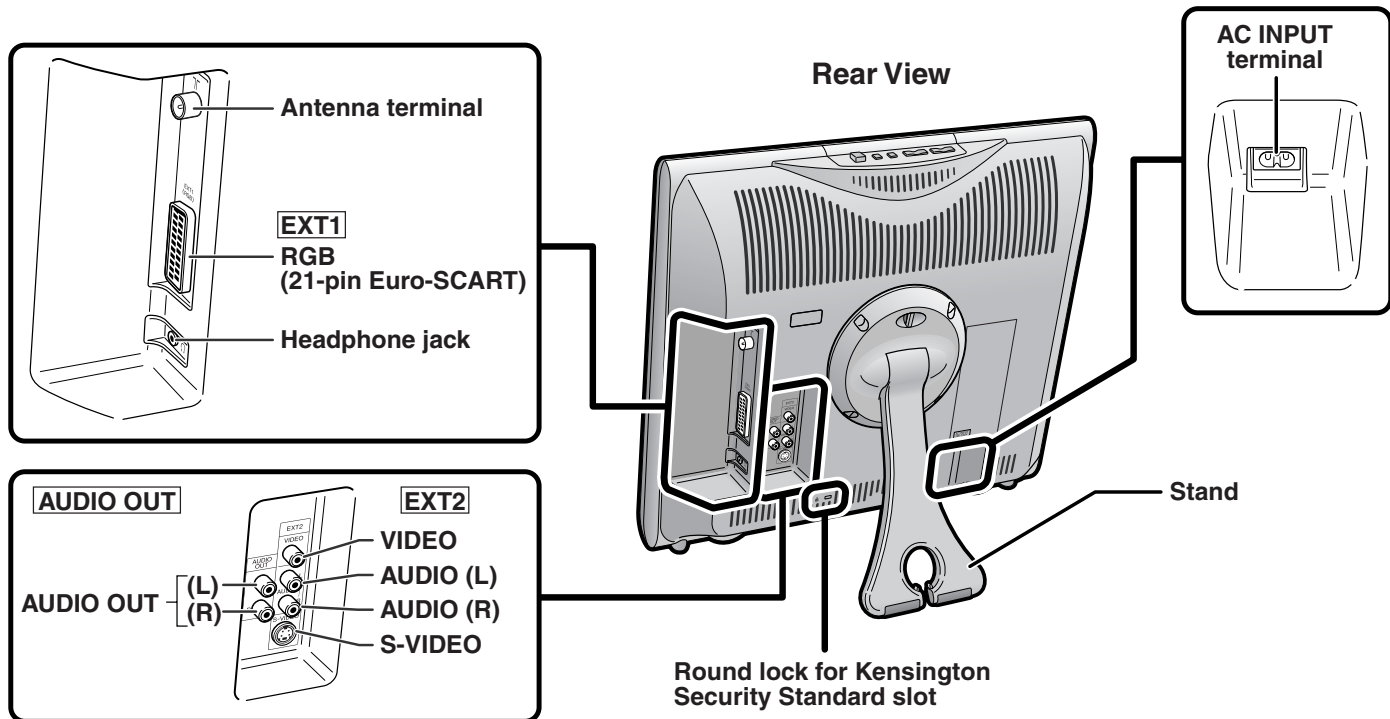

### How to Fix the Cables

Pull the cables connected to each terminal. Insert the cables into the stand hole and fix the cables.

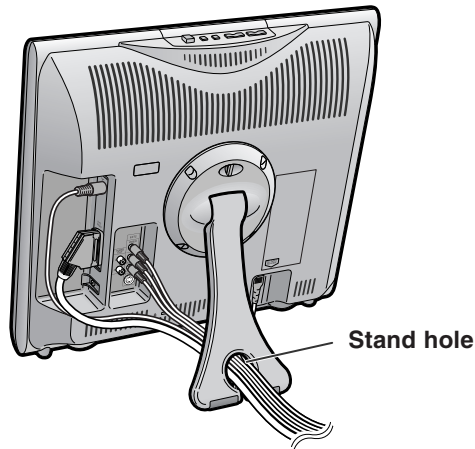

### How to Prevent the LCD TV Set from Falling Over

To prevent the LCD TV set from falling over in case of earthquakes and so on, strap it onto the wall by threading one end of the string through the loop of the stand (①) and fastening the LCD TV set with the string attached to the hook on the wall or the post, etc. (②).

(An example of strapping the LCD TV set onto the wall is shown on the right.)

- The string and hook are commercially available.

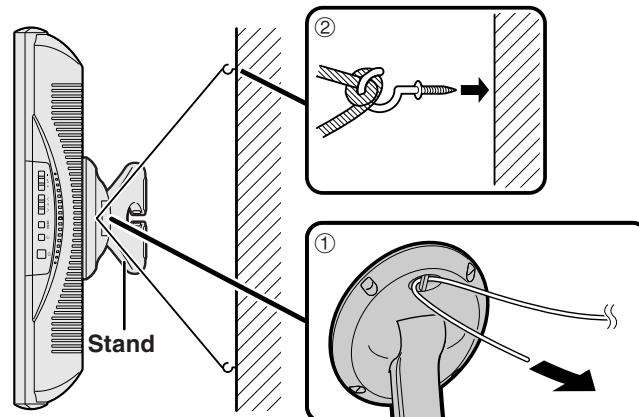



## Part Names of the Remote Control

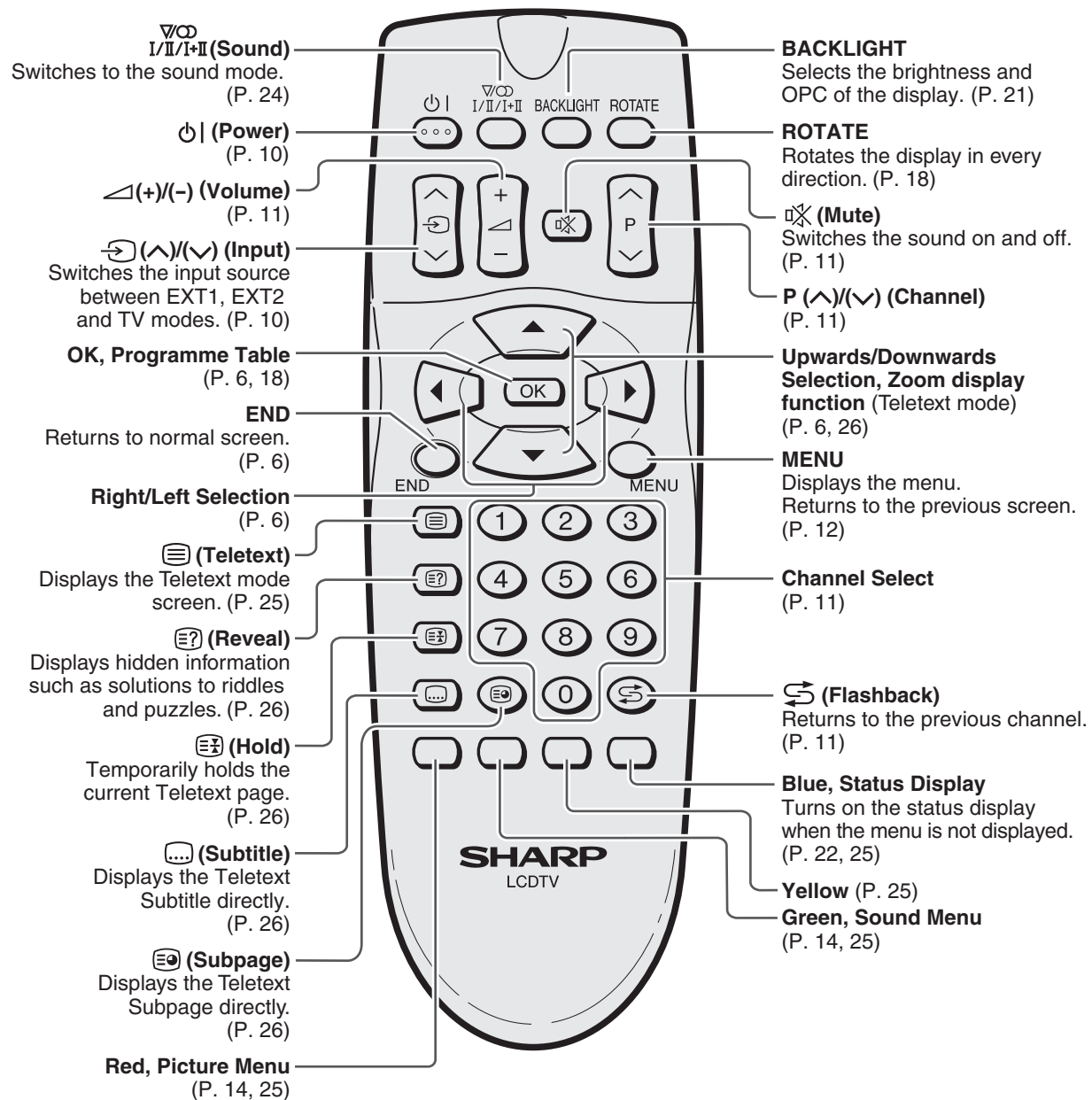

# Basic Operation

## Turning On and Off the Main Power

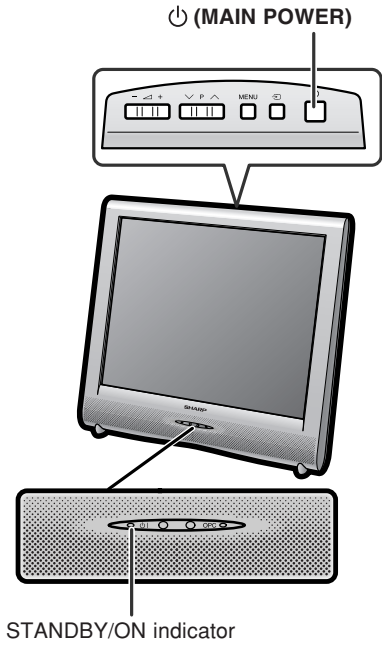

- Press **MAIN POWER**.
  - The STANDBY/ON indicator instantly changes from red to green and the LCD TV set is turned on.
  - The on-screen display appears for a few seconds after turning on the main power.

### On-screen display

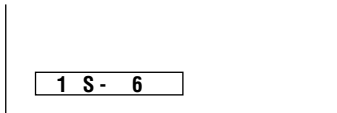

- To turn off the main power, press **MAIN POWER** again.

## STANDBY/ON

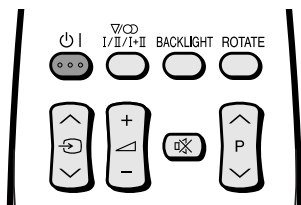

### To turn off the LCD TV

- Press **Power**.
- The STANDBY/ON indicator will turn red.

### To turn the LCD TV back on

- Press **Power** again.
- The STANDBY/ON indicator will turn green.

## Switching the Input Mode (EXT1/EXT2/TV)

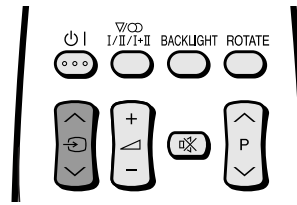

- 1 Turn on the power of the connected devices.
- 2 Press **Input** to select the applicable input source.
  - The screen changes in order of EXT1, EXT2 and TV mode each time **Input** is pressed.

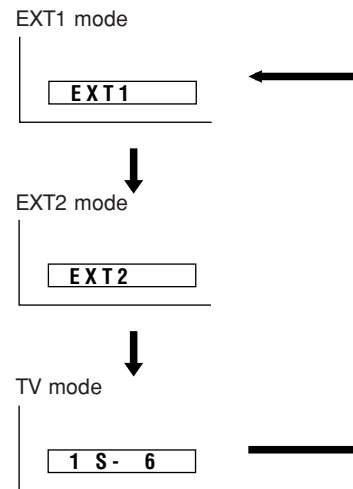

### NOTE

- EXT1: Select this mode when viewing the signals from the video equipment connected to the EXT1 (21-pin Euro-SCART (RGB)) terminal.
- EXT2: Select this mode when viewing the signals from the video equipment connected to the EXT2 terminals using the VIDEO or S-VIDEO terminal for video input. If both VIDEO and S-VIDEO terminals are connected with cables, the S-VIDEO input terminal is selected as the high priority.

## Basic Operation (Continued)

### Sound Volume

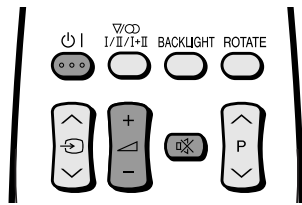

#### To adjust the volume

- Press **▲ (+)** to increase the sound volume.
  - The bar indicator shifts right.

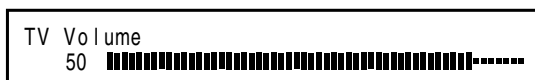

- Press **▼ (-)** to decrease the sound volume.
  - The bar indicator shifts left.



#### To mute the sound

- Press **Mute** to temporarily turn off the sound.
  - “Sound off” is displayed.



- Press **Mute** again to turn off the Mute function.
  - “Sound on” is displayed.



#### NOTE

- When **▲ (+)/▼ (-)** is pressed in the Mute mode, the sound turns on, and the volume indicator is displayed.
- The Mute function is cancelled when **Power** is pressed.

### Changing Channels

You can select channels using **Channel Select** or **P (▲)/(▼) (Channel)**.

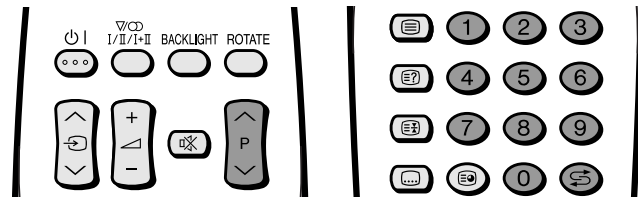

#### NOTE

- To handle the increasing number of channels available, this LCD TV set allows you to select up to 200 channels (0 to 199).

#### ■ Using Channel Select

When selecting the channel using **Channel Select**, finish inputting the channel number by holding down the button for the last digit for a moment.

##### To select a one-digit channel (e.g. Channel 5)

- Hold down the **5** button.

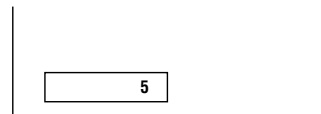

##### To select a two/three-digit channel (e.g. Channel 15)

- 1 Press the **1** button.

- 2 Hold down the **5** button.

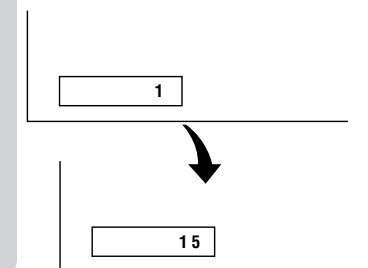

#### ■ Using P (▲)/(▼) (Channel)

- Press **P (▲)** to change the channels in the following order:  
1 → 2 → 3 → ... → 198 → 199 → 0 → 1 → 2 → 3 → ...
- Press **P (▼)** to change the channels in the following order:  
3 → 2 → 1 → 0 → 199 → 198 → ... → 3 → 2 → 1 → ...

#### NOTE

- Channel “0” is reserved for RF output of VCR.
- Channels not set with “Automatic search” or via “Setup” are set to be skipped and therefore cannot be displayed using **P (▲)/(▼) (Channel)**.

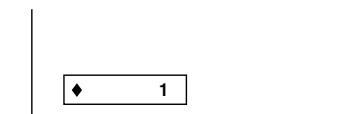

#### ■ Using \$ (Flashback)

- Press **\$** to switch the currently tuned channel to the previously tuned channel.
- Press **\$** again to switch back to the currently tuned channel.

## Basic Operation (Continued)

### Selecting Menu Items

The menus can be used to adjust the various settings of your LCD TV set. Select the desired menu item by following the steps below.

See the next page for each Menu screen.

#### NOTE

- Settings most recently adjusted will be saved in memory.

#### ■ Using the remote control

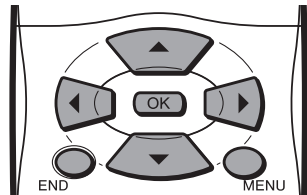

- 1 Press **MENU** to display the Menu screen.
- 2 Press **◀▶** to select the desired menu item.
  - The cursor moves left or right.
  - The cursor indicates the selected menu item.
- 3 Press **▲▼** to select the desired item, and press **◀▶** to adjust the selected item.
  - For some items (e.g. "Programmes" on the "Setup" Menu screen), press **OK** to display the setting screen.

Picture	Sound	Setup	Features
Contrast	[ 50 ]	-	+
Brightness	[ 0 ]	-	+
Colour	[ 0 ]	-	+
Tint	[ 0 ]	-	+
Sharpness	[ 0 ]	-	+
Reset			
- 4 Press **MENU** to return to the previous screen or **END** to return to the normal screen.

#### ■ Using the control panel of the main unit

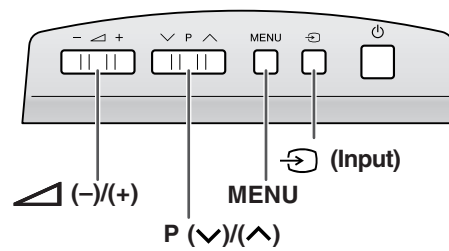

- 1 Press **MENU** to display the Menu screen.
- 2 Press **◀ (-)/(+)** to select the desired menu item.
  - The cursor moves left or right.
  - The cursor indicates the selected menu item.
- 3 Press **P (v)/(^)** to select the desired item, and press **◀ (-)/(+)** to adjust the selected item.
  - For some items (e.g. "Programmes" on the "Setup" Menu screen), press **↻ (Input)** to display the setting screen.

Picture	Sound	Setup	Features
Contrast	[ 50 ]	-	+
Brightness	[ 0 ]	-	+
Colour	[ 0 ]	-	+
Tint	[ 0 ]	-	+
Sharpness	[ 0 ]	-	+
Reset			
- 4 Press **MENU** to return to the previous screen.
  - Each time **MENU** is pressed, you will return to the screen previously shown.

## Basic Operation (Continued)

### ■ Menu setting screens

For details on setting each menu item, refer to the page number indicated below.

#### NOTE

- The illustrations and on-screen displays in this manual are for explanation purposes and may vary slightly from the actual appearance.
- "Programmes" or "First installation" cannot be set when the EXT1 or EXT2 mode is selected as an input mode.

#### Picture

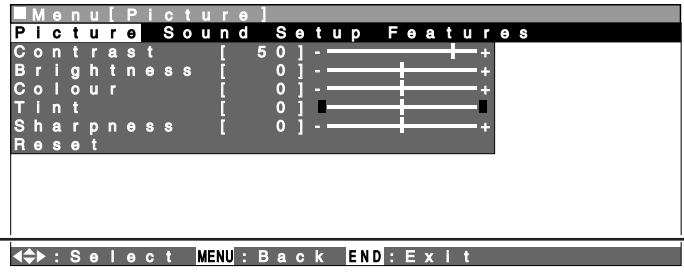

The bar above is an operational guide for the remote control. The bar will change in accordance with each menu setting screen.

	Page
Contrast .....	14
Brightness .....	14
Colour .....	14
Tint .....	14
Sharpness .....	14
Reset .....	14

#### Sound

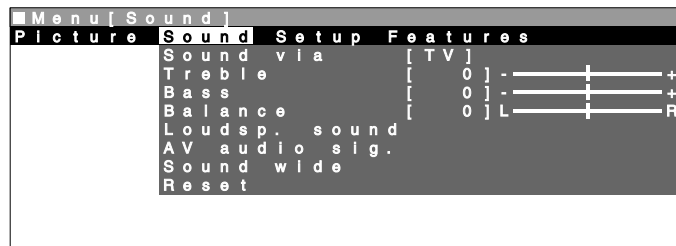

	Page
Sound via .....	15
Treble .....	14
Bass .....	14
Balance .....	14
Loudsp. sound .....	15
AV audio sig. ....	15
Sound wide .....	15
Reset .....	14

#### Setup

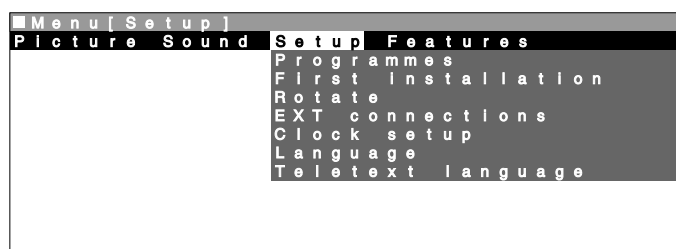

	Page
Programmes .....	16, 17
First installation .....	6
Rotate .....	18
EXT connections .....	19
Clock setup .....	20
Language .....	20
Teletext language .....	20

#### Features

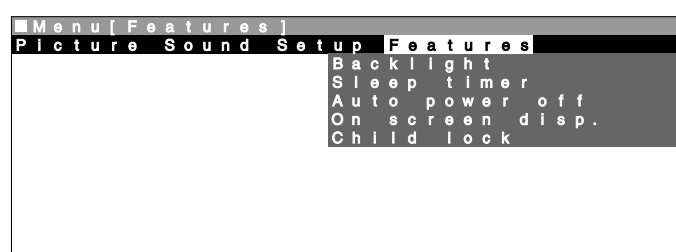

	Page
Backlight .....	21
Sleep timer .....	21
Auto power off .....	21
On screen disp. ....	22
Child lock .....	22, 23

# Useful Features

## Picture Adjustments

Adjust the picture to suit your preference. See the table below for the adjustment items.

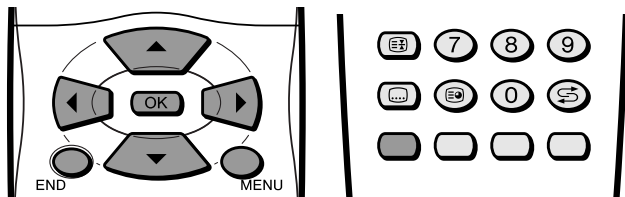

- 1 Press **MENU** to display the Menu screen.
  - The Picture Menu screen can be displayed directly by pressing the **Red** button.

- 2 Press **◀▶** to select "Picture".

- 3 Press **▲▼** to select a specific adjustment item.

Picture	Sound	Setup	Features
Contrast	[ 50 ]	-	+
Brightness	[ 0 ]	-	+
Colour	[ 0 ]	-	+
Tint	[ 0 ]	-	+
Sharpness	[ 0 ]	-	+
Reset			

- 4 Press **◀▶** to adjust the item to your desired position.

- 5 Press **END** to exit.

Selected item	◀ button	▶ button
Contrast	For less contrast	For more contrast
Brightness	For less brightness	For more brightness
Colour	For less colour intensity	For more colour intensity
Tint	Skin tones become purplish.	Skin tones become greenish.
Sharpness	For less sharpness	For more sharpness

### NOTE

- When resetting all adjustment items to factory preset values, perform the following procedure.
  - ① Press **▲▼** to select "Reset", and press **OK**.
  - ② Press **▲▼** to select "Yes", and press **OK**.

## Sound Adjustments

Adjust the sound quality and volume to suit your preference. See the table below for the adjustment items.

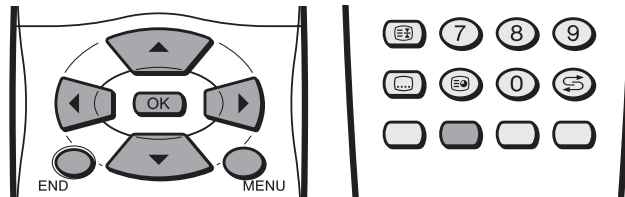

- 1 Press **MENU** to display the Menu screen.
  - The Sound Menu screen can be displayed directly by pressing the **Green** button.

- 2 Press **◀▶** to select "Sound".

- 3 Press **▲▼** to select a specific adjustment item.

Sound	Setup	Features
Sound via	[ TV ]	
Treble	[ 0 ]	- +
Bass	[ 0 ]	- +
Balance	[ 0 ]	L R
Loudsp. sound		
AV audio sig.		
Sound wide		
Reset		

- 4 Press **◀▶** to adjust the item to your desired position.

- 5 Press **END** to exit.

Selected item	◀ button	▶ button
Treble*	For weaker treble	For stronger treble
Bass*	For weaker bass	For stronger bass
Balance*	Increase the volume of the speaker on the left side.	Increase the volume of the speaker on the right side.

\* These items cannot be adjusted when "Sound via" is set to "Hi-fi".

### NOTE

- When resetting all adjustment items to factory preset values, perform the following procedure.
  - ① Press **▲▼** to select "Reset", and press **OK**.
  - ② Press **▲▼** to select "Yes", and press **OK**.



## Useful Features (Continued)

### Sound Mode Settings

You can make various sound mode settings.

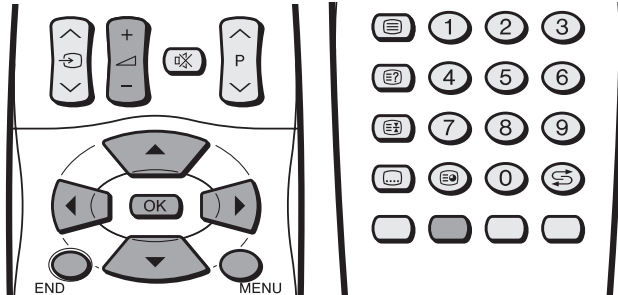

- 1** Perform steps 1 and 2 in **Sound Adjustments** to display the Sound Menu screen.
- 2** Press ▲/▼ to select the desired item, and press **OK**.
- 3** Press ▲/▼ to select the sound mode, and press **OK**.
- 4** Press **END** to exit.

Selected item	Choice
Sound via	TV ↔ Hi-fi
Loudsp. sound	Stereo ↔ Mono Sound 1 ↔ Sound 2 ↔ Sound 1+2 ↔ Mono
AV audio sig.	Sound 1 ↔ Sound 2 ↔ Sound 1+2
Sound wide	On (For increasing the spread of the sound) ↔ Off

#### NOTE

##### For the "Sound via" setting

- When setting "Sound via" to "Hi-fi" in the Sound Menu screen, the sound from the built-in speakers will be turned off. To exit this mode, switch "Sound via" from "Hi-fi" to "TV" in the Sound Menu screen.
- Pressing ▲ (+)/▼ (-) will display the volume indicator shown below. You can adjust the volume by pressing ▲ (+)/▼ (-).



##### For the "Loudsp. sound" setting

- The sound output modes differ depending on whether or not a NICAM or A2 stereo signal is received. See page 24.

##### For the "AV audio sig." setting

- Select "Sound 1" or "Sound 2" when playing back the video from mono-video recorders and "Sound 1+2" when playing back from stereo-video recorders.

## Useful Features (Continued)

### Programmes

#### [1] Automatic Search

Perform the procedure below to search for and store new TV programmes after the First Installation routine.

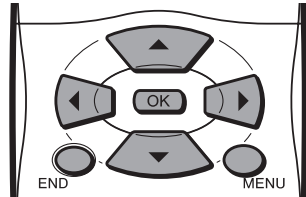

- 1 Press **MENU** to display the Menu screen.
- 2 Press **◀▶** to select "Setup".
- 3 Press **▲/▼** to select "Programmes", and press **OK**.
- 4 Press **▲/▼** to select "Automatic search", and press **OK**.

```
Automatic search
Manual adjustment
Sort
Erase programme range
Enter / Change name
```

- 5 Press **▲/▼** to select the desired item, and press **◀▶** to make the setting.

```
Country          ◀ UK ▶
Colour system    PAL
Sound system     I
Store prog. from
Start search
```

#### NOTE

- You can change "Colour system" and "Sound system" only when "Other count." is selected in "Country".

- 6 Press **▲/▼** to select "Store prog. from", and press **OK** to display the "Store prog. from" screen.

```
0 ▶  S - 6      8 E - 9      16 E - 54
1  S - 8      9 E - 10     17 E - 56
2  S - 8      10 E - 11    18 E - 57
3  S - 10     11 E - 36     19
4  S - 11     12 E - 37     20
5  M - 3      13 E - 38     21
6  M - 5      14 E - 50     22
7  M - 6      15 E - 53     23
```

- 7 Press **▲/▼/◀▶** to select the programme position from which the programmes are to be stored, and press **OK** to return to the automatic search setting screen.

```
0 ▶  S - 6      8 E - 9      16 E - 54
1  S - 8      9 E - 10     17 E - 56
2  S - 8      10 E - 11    18 E - 57
3  S - 10     11 E - 36     19
4  S - 11     12 E - 37     20
5  M - 3      13 E - 38     21
6  M - 5      14 E - 50     22
7  M - 6      15 E - 53     23
```

#### NOTE

- See page 6 for details on the search process.

- 8 Press **▲/▼** to select "Start search", and press **OK** to begin the automatic programme search.

```
Country          UK
Colour system    PAL
Sound system     I
Store prog. from
Start search
```

- 9 "Search is completed" is displayed, and press **END** to exit.

#### [2] Manual Adjustment

Individual settings of programmes can be adjusted.

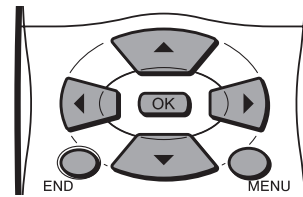

- 1 Perform steps 1 to 3 in [1] Automatic Search to display the "Programmes" screen.
- 2 Press **▲/▼** to select "Manual adjustment", and press **OK**.

```
Automatic search
Manual adjustment
Sort
Erase programme range
Enter / Change name
```

- 3 Press **▲/▼** to select the desired item, and press **◀▶** to make the setting.

```
Channel          ◀ 199 ▶
Frequency        224.25 MHz
Name             E - 12
Colour system    PAL
Sound system     I
Skip             Off
```

- 4 Press **END** to exit.

Selected item	Choice/Value range	Description
Channel	0-199	The channel changes to the higher or lower channel.
Frequency	044 - 859 (MHz)	Receivable frequencies depending on TV norm, installation site, and range.
Name	Alphabets, numerical values and symbols (e.g. !, t, etc.)	Programme name (up to 5 characters).
Colour system	Auto, PAL, SECAM	Colour norm
Sound system	B/G, I, D/K, L/L', Auto	TV norm
Skip	On ↔ Off	Channel numbers with a "♦" (RED) mark on the left are set to Skip.

#### NOTE

- Depending on the settings in the colour system of the channels, switching between channels may be slow. If you want to speed up channel switching, switch "Auto" in "Colour system" to the current reception system (PAL or SECAM).

## Useful Features (Continued)

### [3] Sort

The programme positions for individual programmes can be changed freely.

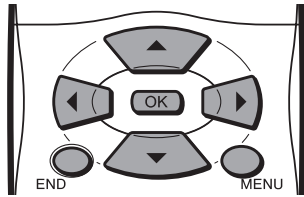

**1** Perform steps 1 to 3 in [1] **Automatic Search** to display the "Programmes" screen.

**2** Press ▲/▼ to select "Sort", and press **OK**.

```
Automatic search
Manual adjustment
Sort
Erase programme range
Enter / Change name
```

**3** Press ▲/▼/◀/▶ to select the desired programme, and press **OK** to sort.

- When **OK** is pressed, the Move mode is activated. Press ▲/▼ to move the currently marked programme to the desired programme position. When the channel has moved to the desired position, all the preceding/subsequent channel position will go up/down. Press **OK** to exit the Move mode.

0			8	E -	9	16	E -	54
1	S -	6	9	E -	10	17	E -	56
2	S -	8	10	E -	11	18	E -	57
3	S -	10	11	E -	36	19		
4	S -	11	12	E -	37	20		
5	E -	3	13	E -	38	21		
6	E -	5	14	E -	50	22		
7	E -	6	15	E -	53	23		

**4** Press **END** to exit.

### [4] Erase Programme Range

The individual programme or programmes in a connected range can be erased.

**1** Perform steps 1 to 3 in [1] **Automatic Search** to display the "Programmes" screen.

**2** Press ▲/▼ to select "Erase programme range", and press **OK**.

```
Automatic search
Manual adjustment
Sort
Erase programme range
Enter / Change name
```

**3** Press ▲/▼/◀/▶ to select the programme to be erased, and press **OK**.

- If you want to erase programmes in a connected range, select the programme at the beginning of the desired range.

0			8	E -	9	16	E -	54
1	S -	6	9	E -	10	17	E -	56
2	S -	8	10	E -	11	18	E -	57
3	S -	10	11	E -	36	19		
4	S -	11	12	E -	37	20		
5	E -	3	13	E -	38	21		
6	E -	5	14	E -	50	22		
7	E -	6	15	E -	53	23		

**4** If you are erasing programmes in a connected range, press ▲/▼/◀/▶ to select the programme at the end of the range.

0			8	E -	9	16	E -	54
1	S -	6	9	E -	10	17	E -	56
2	S -	8	10	E -	11	18	E -	57
3	S -	10	11	E -	36	19		
4	S -	11	12	E -	37	20		
5	E -	3	13	E -	38	21		
6	E -	5	14	E -	50	22		
7	E -	6	15	E -	53	23		

**5** Press **OK** to erase the selected programme(s). All the subsequent programmes move up.

**6** Press **END** to exit.

### [5] Enter/Change Name

The name of an individual programme can be entered or changed.

**1** Perform steps 1 to 3 in [1] **Automatic Search** to display the "Programmes" screen.

**2** Press ▲/▼ to select "Enter/Change name", and press **OK**.

```
Automatic search
Manual adjustment
Sort
Erase programme range
Enter / Change name
```

**3** Press ▲/▼/◀/▶ to select the desired programme, and press **OK**.

0			8	E -	9	16	E -	54
1	-	6	9	E -	10	17	E -	56
2	S -	8	10	E -	11	18	E -	57
3	S -	10	11	E -	36	19		
4	S -	11	12	E -	37	20		
5	E -	3	13	E -	38	21		
6	E -	5	14	E -	50	22		
7	E -	6	15	E -	53	23		

**4** Press ◀/▶ to select the input position, and press ▲/▼ to select the desired character.

0			8	E -	9	16	E -	54
1	A -	6	9	E -	10	17	E -	56
2	S -	8	10	E -	11	18	E -	57
3	S -	10	11	E -	36	19		
4	S -	11	12	E -	37	20		
5	E -	3	13	E -	38	21		
6	E -	5	14	E -	50	22		
7	E -	6	15	E -	53	23		

**5** Press **OK** to accept the name entered, and press **END** to exit.

## Useful Features (Continued)

### Using the Programme Table

The Programme table shows a list of all receivable programmes. They are located in channels 0 to 199.

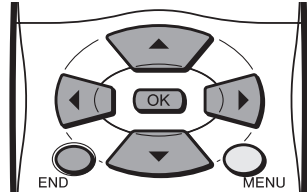

#### To select the desired programme

- 1 Press **OK** to display the Programme table.
- 2 Press **▲/▼/◀/▶** to select the desired programme.
  - To display the next or previous list of the Programme table, press **▲/▼** when the cursor is at a programme in the lower-right or upper-left position, or press **◀/▶** when the cursor is at a programme in the right or left column.

0			8	m	9	16	m	54
1	S	6	9	m	10	17	m	56
2	S	8	10	m	11	18	m	57
3	S	10	11	m	36	19		
4	S	11	12	m	37	20		
5	m	3	13	m	38	21		
6	m	5	14	m	50	22		
7	m	6	15	m	53	23		

- 3 Press **OK** to display the selected programme.
- 4 Press **END** to exit.

### Rotate

You can set the orientation of the picture.

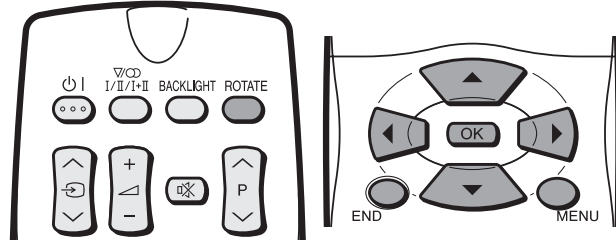

- 1 Press **MENU** to display the Menu screen.
  - 2 Press **◀/▶** to select "Setup".
  - 3 Press **▲/▼** to select "Rotate", and press **OK**.
  - 4 Press **▲/▼** to select the desired mode, and press **OK**.
- Normal

Mirror

Rotate

Upside down
- 5 Press **END** to exit.

#### ■ Directly setting the Rotate

Press **ROTATE** to select the desired mode.

- Each time you press **ROTATE**, the mode changes as follows.

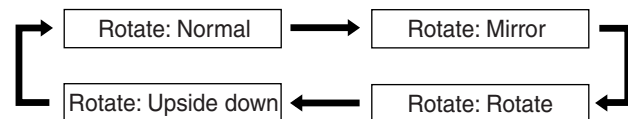

#### NOTE

- "Rotate" is set to "Normal" at the factory setting.

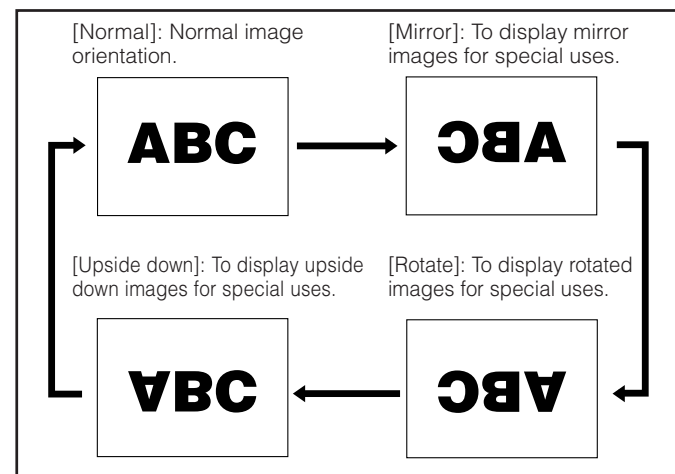

## Useful Features (Continued)

### EXT Connections

It is possible to manually adjust various settings for connections with external devices on the "EXT connections" screen.

#### ■ EXT1/EXT2

Select the appropriate signal type and colour standard for the signals from the video equipment connected to the EXT1 or EXT2 terminal.

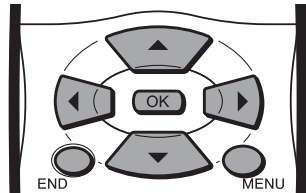

**1** Perform steps 1 and 2 in **Rotate** to display the Setup Menu screen.

**2** Press ▲/▼ to select "EXT connections", and press **OK**.

**3** Press ▲/▼ to select "EXT1", "EXT2 (Y/C)", or "EXT2 (CVBS)", and press **OK**.

```
EXT 1
EXT 2 ( Y / C )
EXT 2 ( CVBS )
```

**4** Press ▲/▼ to select the desired item, and press ◀▶ to make the setting. (See the table below for details.)

```
Signal type ◀ CVBS ▶
AFC Mode 1
Colour system Auto
```

**5** Press **END** to exit.

Selected item	Choice	Description
Signal type*	Auto, CVBS, RGB	To select the signal type of external equipment.
AFC	Mode 1, Mode 2	To select frequency control modes. Mode 1 is suitable for DVD players or decoders, and Mode 2 is suitable for VCRs or Camcorders.
Colour system	Auto, PAL, SECAM, N358 (NTSC 3.58), N443 (NTSC 4.43), PAL-M, PAL-N, PAL60	Colour norm

\* This item is visible only when "EXT1" is selected for the "EXT connections" setting.

#### NOTE

- If no (colour) image is displayed, try to change to a different signal type.
- Depending on the compatibility with the various types of equipment, the picture may become skewed. In this case, select the "AFC" (Automatic Frequency Control) mode that will improve the picture.
- Switching between AV input signals may be slow, depending on the settings in "Colour system". If you want to speed up signal switching, select "Auto" in "Colour system" to the current reception colour system.

## Useful Features (Continued)

### Clock Setup

The Sleep timer that turns power off at the specified time does not work unless the clock has been adjusted. Be sure to adjust the clock first.

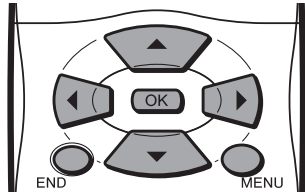

- 1 Press **MENU** to display the Menu screen.
- 2 Press **◀▶** to select "Setup".
- 3 Press **▲▼** to select "Clock setup", and press **OK**.
- 4 Press **▲▼** to set the time, and press **OK**.



- 5 Press **END** to exit.

#### NOTE

- The time is automatically set/corrected via the Teletext broadcast when available.

### Language

The language for the on-screen display can be selected from English, Spanish, German, French, Italian, Swedish, Dutch, Russian, Portuguese, Turkish, Greek, Finnish and Polish.

- 1 Perform steps 1 and 2 in **Clock Setup** to display the Setup Menu screen.
- 2 Press **▲▼** to select "Language", and press **OK**.
- 3 Press **▲▼/◀▶** to select the desired language, and press **OK**.

English	Russian
Español	Português
Deutsch	Türkçe
Français	Greek
Italiano	Suomi
Svenska	Polski
Nederlands	

- 4 Press **END** to exit.

### Teletext Language

The language for the Teletext can be selected.

- 1 Perform steps 1 and 2 in **Clock Setup** to display the Setup Menu screen.
- 2 Press **▲▼** to select "Teletext language", and press **OK**.
- 3 Press **▲▼** to select the desired language, and press **OK**.

West europe
East europe
Turkish/Greek
Cyrillic

- 4 Press **END** to exit.



## Useful Features (Continued)

### Backlight

You can make the setting for the brightness of the screen.

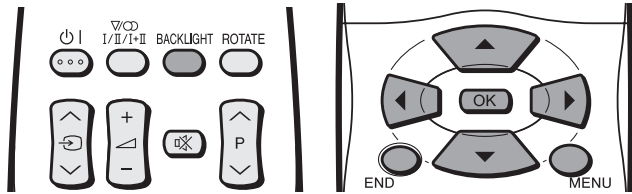

- 1 Press **MENU** to display the Menu screen.
- 2 Press **◀▶** to select "Features".
- 3 Press **▲▼** to select "Backlight", and press **OK**.
- 4 Press **▲▼** to select the desired mode, and press **OK**.
- 5 Press **END** to exit.

Selected item	Factory setting	Choice	
Backlight*	[Bright] Maximum brightness	[Medium]	Suitable for viewing in well-lit areas. Saves energy.
		[Dark]	Sufficiently bright when viewing in dim areas.
		[Auto (OPC)]	Screen brightness is adjusted according to the ambient light of the room.

\* The Backlight setting can be switched with one touch using the remote control (see below).

#### ■ Directly setting the Backlight

You can change the setting of Backlight directly.

Press **BACKLIGHT** to select the desired mode.

- Each time you press **BACKLIGHT**, the mode changes as follows.

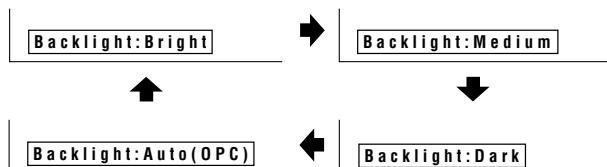

#### NOTE

- See the table above for details of the each brightness setting.
- When set to "Auto (OPC)", make sure that no object obstructs the OPC sensor, which could affect its ability to sense surrounding light.

### Sleep Timer

You can set "Sleep timer" to automatically turn off the LCD TV set.

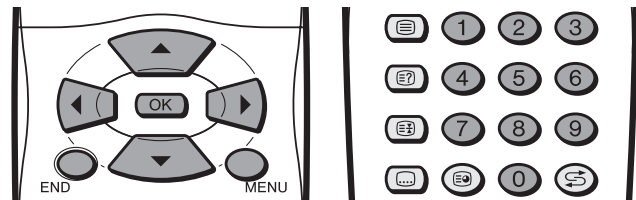

- 1 Perform steps 1 and 2 in **Backlight** to display the Features Menu screen.
- 2 Press **▲▼** to select "Sleep timer", and press **OK**.
- 3 Press **Channel Select** or **▲▼** to select the time, and press **◀▶**. Press **▲▼** to set "On".



- 4 Press **END** to exit.

Selected item	Input value/Choice	Description
Sleep timer	HH:MM Off ↔ On	The LCD TV set automatically turns off.

#### NOTE

- Be sure to adjust the clock with "Clock setup" in the Setup Menu before setting "Sleep timer".
- The time is automatically set/corrected via the Teletext broadcast when available.
- When not using the LCD TV set for a long period of time, turn off the main power.

### Auto Power Off

You can set the power to automatically turn off if there is no signal for 5 minutes.

- 1 Perform steps 1 and 2 in **Backlight** to display the Features Menu screen.
- 2 Press **▲▼** to select "Auto power off", and press **OK**.
- 3 Press **▲▼** to select "On", and press **OK**.



- 4 Press **END** to exit.

#### NOTE

- "Off" is factory preset value.

## Useful Features (Continued)

### On-Screen Display

You can adjust various settings for on-screen displays.

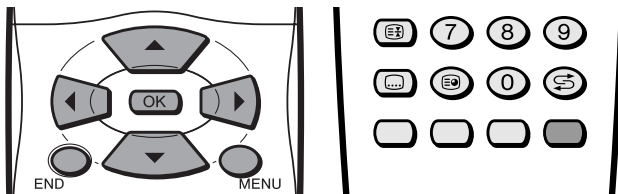

- 1 Press **MENU** to display the Menu screen.
- 2 Press **◀▶** to select "Features".
- 3 Press **▲/▼** to select "On screen disp.", and press **OK**.
- 4 Press **▲/▼** to select the desired item.
- 5 Press **◀▶** to make the setting.
- 6 Press **END** to exit.

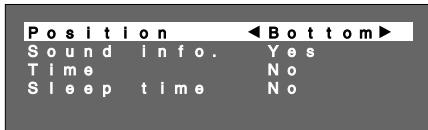

Selected item	Choice	Description
Position	Bottom ↔ Top	To select the position of the on-screen display.
Sound info.	No ↔ Yes	To select whether or not sound info is to be displayed, when a channel has been selected.
Time	No ↔ Yes	To select information to be displayed on the on-screen display.
Sleep time	No ↔ Yes	

#### NOTE

- The status display appears by pressing the **Blue** button.

### Child Lock

#### Important:

- Please refer to page 31 for "IMPORTANT NOTE ON DISENGAGING ADVANCED CHILD LOCK".

The Child lock function blocks the viewing of any channels. To use this function, you need to define your PIN (Personal Identification Number) first.

#### [1] Defining a PIN

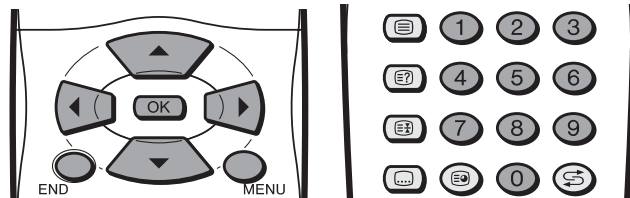

- 1 Press **MENU** to display the Menu screen.
- 2 Press **◀▶** to select "Features".
- 3 Press **▲/▼** to select "Child lock", and press **OK** to display the PIN input screen.
- 4 Input the desired four-digit PIN (e.g. 1234) with **Channel Select**, and press **OK**.



#### NOTE

- Be sure to make a note of your PIN before pressing **OK**.
- The PIN will not be set if **MENU** or **END** is pressed before the fourth digit has been input.

- 5 Press **OK** to accept the input PIN.

#### [2] Setting a Child Lock

- There are two different ways of activating a Child lock:
  1. General child lock for all programmes immediately
  2. Programme-position-related child lock without time limit

#### To set a Child Lock for all programmes with a time limit

- 1 Perform steps 1 to 3 in [1] **Defining a PIN** to display the PIN input screen.
- 2 Input your four-digit PIN (e.g. 1234) with **Channel Select**.

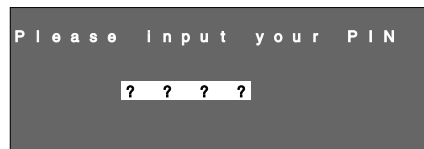

- When the PIN is correctly input, the "Child lock" screen is displayed.

## Useful Features (Continued)

- 3** Press ▲/▼ to select “For all programmes”, and press **OK**.

```

For all programmes
For individual prog. only
Change PIN
Cancel PIN
    
```

- 4** Press ▲/▼ to select “Yes”, and press **OK**.  
• The lock remains effective until “No” is selected.

```

Yes
No
    
```

- 5** Press **END** to exit.

### To set a Child Lock for individual programmes without time limit

- 1** Perform steps 1 and 2 in [2] **Setting a Child Lock** to display the “Child lock” screen.

- 2** In step 3 above, press ▲/▼ to select “For individual prog. only”, and press **OK**.

```

For all programmes
For individual prog. only
Change PIN
Cancel PIN
    
```

- 3** Press ▲/▼/◀/▶ to select the desired programme.

- 4** Press **OK** to lock the programme.  
• The locked programme is displayed in red.

#### NOTE

- To unlock the programme, select the programme, and press **OK**.
- The Child lock remains effective until it is cancelled.

- 5** Press **END** to exit.

### [3] Changing/Cancelling a PIN

#### To change a PIN

- 1** Perform steps 1 and 2 in [2] **Setting a Child Lock** to display the “Child lock” screen.

- 2** Press ▲/▼ to select “Change PIN”, and press **OK**.  
• The currently defined PIN is displayed.

```

For all programmes
For individual prog. only
Change PIN
Cancel PIN
    
```

- 3** Input the new four-digit PIN (e.g. 5678) with **Channel Select**, and press **OK**.

```

Please define your PIN
5 6 7 8
    
```

- 4** Press **END** to exit.

#### To cancel a PIN

- 1** In step 2 above, press ▲/▼ to select “Cancel PIN”, and press **OK**.

- 2** Press ▲/▼ to select “Yes”, and press **OK**.

```

Yes
No
    
```

### [4] Temporarily cancelling the Child Lock setting

You can view a programme for which a Child lock has been set by temporarily cancelling the Child lock setting. Perform the procedure below to input your PIN and cancel the Child lock if you are prompted to do so.

When the PIN input screen is displayed, input your PIN with **Channel Select**.

- The normal screen appears when the PIN is correctly input.

```

Please input your PIN
? ? ? ?
    
```

## Useful Features (Continued)

### NICAM Broadcast Selection

This enables the selection of the reception mode when receiving a NICAM-I or NICAM-B/G signal. To let you enjoy NICAM broadcasting, this LCD TV set receives NICAM stereo system and bilingual broadcasts.

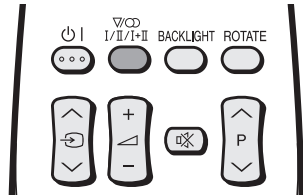

#### Stereo

The LCD TV set is receiving a stereo broadcast.

- Each time you press  $\frac{\nabla \infty}{I/II/I+II}$  (**Sound**), the mode changes between "Stereo" and "Mono".
- When "Mono" is selected, the TV sound is output monaurally.

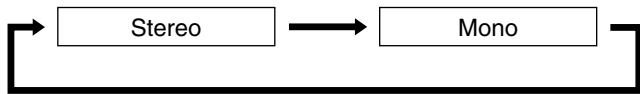

#### Bilingual

The LCD TV set is receiving a bilingual broadcast.

- Each time you press  $\frac{\nabla \infty}{I/II/I+II}$  (**Sound**), the mode changes as follows:

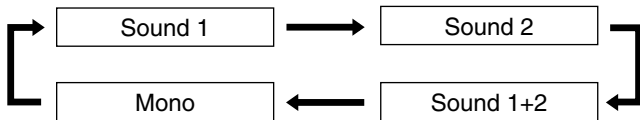

#### NOTE

- If the button is not pressed for a few seconds, the mode setting is automatically terminated and the LCD TV set returns to the normal mode.

### A2 Stereo Broadcast Selection

This enables the selection of the reception mode when receiving an A2 stereo signal. To let you enjoy A2 stereo broadcasting, this LCD TV set receives A2 stereo system and bilingual broadcasts.

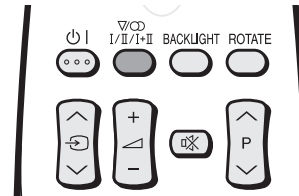

#### Stereo

The LCD TV set is receiving a stereo broadcast.

- Each time you press  $\frac{\nabla \infty}{I/II/I+II}$  (**Sound**), the mode changes between "Stereo" and "Mono".
- When "Mono" is selected, the TV sound is output monaurally.

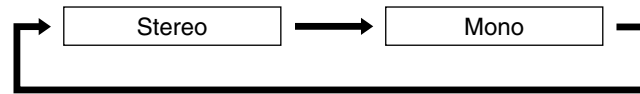

#### Bilingual

The LCD TV set is receiving a bilingual broadcast.

- Each time you press  $\frac{\nabla \infty}{I/II/I+II}$  (**Sound**), the mode changes as follows:

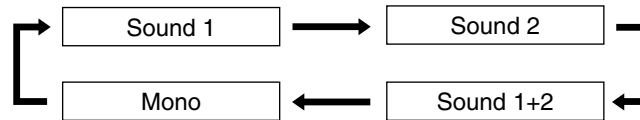

#### NOTE

- If the button is not pressed for a few seconds, the mode setting is automatically terminated and the LCD TV set returns to normal mode.

# Teletext

## ■ What is Teletext?

Teletext is an information service organised like a magazine, which is provided by some TV stations in addition to regular television broadcasting. Your LCD TV set receives special Teletext signals broadcast by a TV station, processes the information and displays it graphically on the screen. News, weather and sports information, stock exchange prices, programme reviews and closed captioning for people hard of hearing are among the many services available through Teletext.

## ■ Teletext mode

Teletext is activated with  (**Teletext**) on the remote control and is also closed with it. The LCD TV set can be controlled in Teletext mode directly by inputting commands with the remote control and indirectly through the on-screen display (menu system).

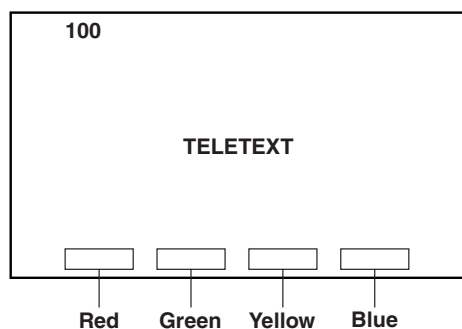



## ■ Operating instructions in Teletext mode

- The FLOF system for Teletext is transmitted in the UK currently.
- The TOP system for Teletext is transmitted in Germany currently.
- If TOP Teletext is broadcast, a control line and TOP line can be displayed on the screen. The TOP line involves the operating instructions associated with all of the **Coloured** buttons if TOP text is transmitted.

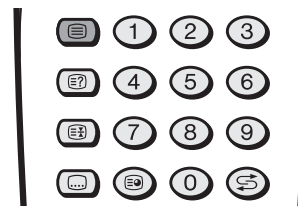
## [1] Turning on and off Teletext mode



- 1 Select a TV channel that is broadcasting the Teletext programme.
- 2 Press  (**Teletext**) to display Teletext screen.
  - To turn off the Teletext mode, press  (**Teletext**) again.

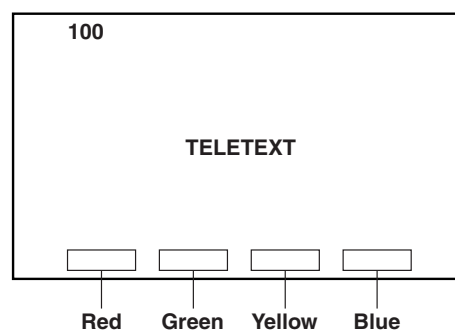

### NOTE

- For selecting the language for the Teletext screen, see "Teletext Language" on page 20.

## [2] Using the TOP line

When TOP Teletext is being broadcast, you can display the TOP line, which contains the operating instructions on the screen.

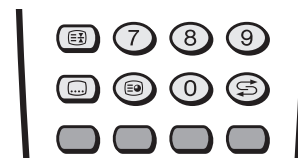

- Press the **Coloured** buttons to operate the Teletext screen.
- Press **Red** to display the previous page and **Green** to display the next page. **Yellow** and **Blue** are as indicated on the TOP line.



## Teletext (Continued)

### [3] Changing subpages

If a page has been selected from among several subpages, you can display a control line which contains the subpage numbers.

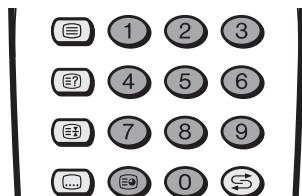

**1** Press (Subpage).

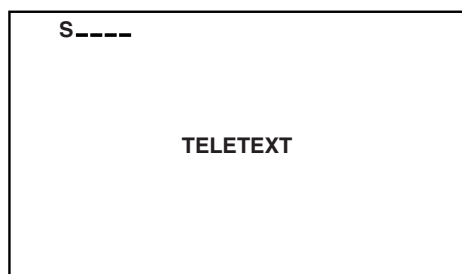

**2** Press **Channel Select** to select the desired subpage number.

**3** Press (Subpage) to turn off the control line.

### [4] Useful Features for Teletext

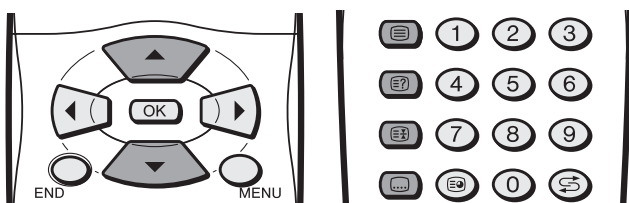

- (**Hold**) on the remote control can be used to hold the current teletext page.  
Press the button again to cancel the Hold mode.
- can be used to zoom the current Teletext page as shown below.
  - The screen is displayed in each mode each time is pressed.

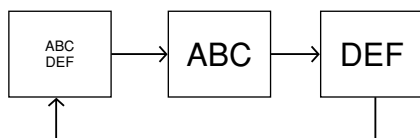

- (**Subtitle**) can be used to quickly activate subtitles.
  - Press (**Teletext**) to deactivate subtitles.
- (**Reveal**) can be used to display hidden information such as solutions to riddles and puzzles.  
Press the button again to hide the information.



## Connecting External Devices

You can enjoy picture and sound by connecting devices, such as a VCR or home video game system, to the terminals located on the rear of the LCD TV set.

When connecting an external device, turn off the power of the LCD TV set first to prevent any possible damage.

### Example of external devices that can be connected

#### To EXT1 terminal

- Decoder

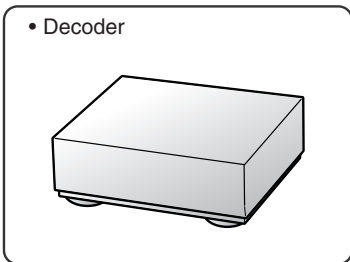

#### To EXT2 terminal

<Example>

- Camcorder
- Home video game system
- VCR

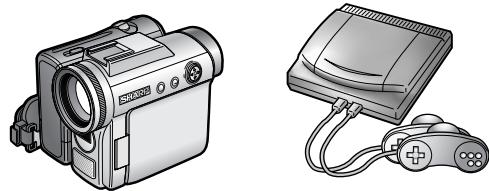

\* If your external device has an S-VIDEO terminal, S-VIDEO connection is recommended.

#### To AUDIO OUT terminal

<Example>

- Audio amplifier

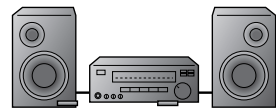

#### NOTE

- For the cable, use a commercially available audio/video cable.
- Only connect audio/video signals to EXT1 and 2 terminals. Connecting other signals may result in a malfunction.
- The VIDEO input terminal and the S-VIDEO input terminal on the EXT2 are shared connections with priority given to the S-VIDEO terminal. If both terminals are connected, the video signals from the S-VIDEO input terminal are selected for the EXT2 input. When viewing video from the VIDEO input terminal, do not connect anything to the S-VIDEO input terminal.
- For more information about external device connections, see the operation manuals of your external devices.

## Connecting External Devices (Continued)

### Connecting to the EXT1/EXT2 Terminals

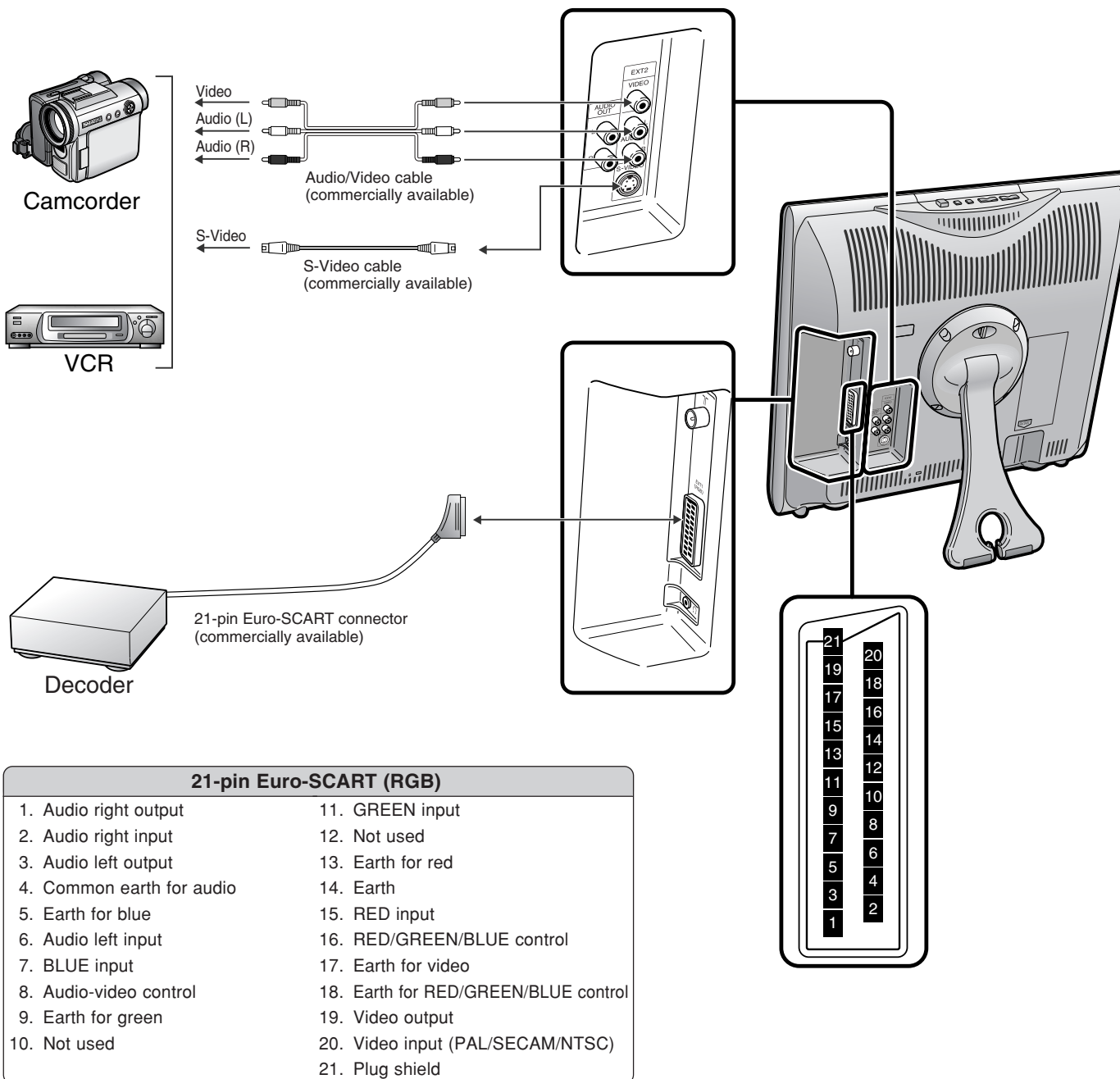







#### NOTE

- If your VCR (or other external devices) has an S-Video terminal, S-VIDEO connection is recommended. (Use an S-Video cable.)
- When you connect external devices to both S-VIDEO and VIDEO terminals (and if you select EXT2), you can only view pictures from the S-VIDEO terminal.
- You cannot view multiple or synthesised pictures by connecting two or more external devices. When connecting an external device, make sure to connect the video and audio cables to the corresponding terminals.

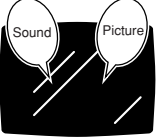
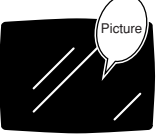
# Troubleshooting

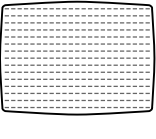
Before calling for repair services, make the following checks for possible remedies to the symptoms encountered.

## LCD TV set

Problem	Check item	Reference page
 <p>There is no picture or sound.</p>	<ul style="list-style-type: none"> <li>Reception other than that of broadcasting stations could be the problem.</li> <li>Make sure the input mode is set to TV.</li> <li>Make sure the main power switch of the LCD TV set is on.</li> </ul>	<p>–</p> <p>10 10</p>
 <p>There is no picture. There is no picture from EXT2 .</p>	<ul style="list-style-type: none"> <li>Make sure the Picture adjustment is properly adjusted.</li> <li>The fluorescent lamp may have reached the end of its service life.</li> <li>Make sure the S-VIDEO terminal has nothing connected.</li> </ul>	<p>14 –</p> <p>8, 28</p>
 <p>There is no sound.</p>	<ul style="list-style-type: none"> <li>Make sure the volume is not set to minimum.</li> <li>Make sure the sound is not set to mute.</li> </ul>	<p>11 11</p>
 <p>There is no picture or sound, just noise.</p>	<ul style="list-style-type: none"> <li>Make sure the antenna cable is properly connected.</li> <li>Bad reception could be the problem.</li> </ul>	<p>5 –</p>
 <p>The picture is not clear.</p>	<ul style="list-style-type: none"> <li>Make sure the antenna cable is properly connected.</li> <li>Bad reception could be the problem.</li> </ul>	<p>5 –</p>
 <p>The picture is too light or improperly tinted.</p>	<ul style="list-style-type: none"> <li>Check the colour adjustment.</li> </ul>	<p>14</p>
 <p>The picture is too dark.</p>	<ul style="list-style-type: none"> <li>Check if "Backlight" is set to "Dark".</li> <li>Check "Contrast".</li> <li>The fluorescent lamp may have reached the end of its service life.</li> </ul>	<p>21 14 –</p>
Remote control does not work.	<ul style="list-style-type: none"> <li>Check if batteries in the remote control have sufficient power.</li> <li>Make sure the remote sensor window is not under strong lighting.</li> </ul>	<p>4 4</p>
Unit cannot be operated.	<ul style="list-style-type: none"> <li>External influences such as lightning, static electricity, etc., may cause improper operation. In this case, operate the unit after turning the power off, or unplugging the AC cord and re-plugging it in 1 or 2 minutes.</li> </ul>	<p>–</p>

### ■ Cautions regarding use in high and low temperature environments

- When the unit is used in a low temperature space (e.g. room, office), the picture may leave trails or appear slightly delayed. This is not a malfunction, and the unit will recover when the temperature returns to normal.
- Do not leave the unit in a hot or cold location. Also, do not leave the unit in a location exposed to direct sunlight or near a heater, as this may cause the cabinet to deform and the LCD panel to malfunction.  
(Storage temperature: –20°C to +60°C (–4°F to +140°F))

## Troubleshooting (Continued)

### Antenna

Problem	Check item
The picture is not sharp. The picture shakes.	<ul style="list-style-type: none"> <li>The reception may be weak.</li> <li>The quality of the broadcast may also be bad.</li> <li>Make sure the antenna is facing the correct direction.</li> <li>Make sure the outside antenna has not been disconnected.</li> </ul>
The picture has ghosts.	<ul style="list-style-type: none"> <li>Make sure the antenna is facing the correct direction.</li> <li>Broadcast waves may be reflected from adjacent mountains or buildings.</li> </ul>
The picture is spotted.	<ul style="list-style-type: none"> <li>There may be interference from automobiles, trains, high-voltage lines, neon lights, etc.</li> <li>There may be interference between the antenna cable and power cable. Try positioning them further apart.</li> </ul>
There are stripes on the screen or colours fade.	<ul style="list-style-type: none"> <li>Is the unit receiving interference from other devices? Transmission antennas of radio broadcasting stations and transmission antennas of amateur radios and mobile phones may also cause interference.</li> <li>Use the unit as far apart as possible from devices that may cause possible interference.</li> </ul>

## Specifications

Model		LC-13SH1E	LC-15SH1E	LC-20SH1E
Items				
LCD panel		13" Advanced Super View & BLACK TFT LCD	15" Advanced Super View & BLACK TFT LCD	20" Advanced Super View & BLACK TFT LCD
Number of dots		921,600 dots		
Video colour system		PAL/SECAM/NTSC		
TV	TV-Standard (CCIR)	B/G, I, D/K, L/L'		
	TV-Tuning System	Auto preset 200 ch.		
	STEREO/BILINGUAL	NICAM, A2 stereo		
	AUTO PRESET	YES		
	CATV	~Hyper Band		
Brightness		430 cd/m <sup>2</sup>		
Lamp life		60,000 hours*		
Viewing angles		H: 170° V: 170°		
Audio amplifier		2.1 W × 2		
Speakers		7.5 cm × 3 cm 2 pcs.	11 cm × 4 cm 2 pcs.	
Terminals	EXT1	21-pin Euro-SCART		
	EXT2	S-VIDEO, VIDEO, AUDIO		
	OUT	AUDIO		
	Antenna	DIN		
	Headphones	3.5 mm ø jack (side)		
OSD language		English/Spanish/German/French/Italian/Swedish/Dutch/Russian/Portuguese/Turkish/Greek/Finnish/Polish		
Power requirement		AC 220 V–240 V, 50/60 Hz		
Power consumption		55 W (1.0 W Standby)	59 W (1.0 W Standby)	74 W (1.0 W Standby)
		AC 220 V–240 V	AC 220 V–240 V	AC 220 V–240 V
Weight (approx.)		3.5 kg, w/o accessories	4.1 kg, w/o accessories	6.3 kg, w/o accessories

\* The typical period of time after which the lamp's power output will have decreased by about half, given that the LCD TV set is used continuously in a 25°C/77°F room under standard lighting and brightness conditions.

### Dimensional Drawings

- The dimensional drawings for each model are shown on the inside back cover.

■ As a part of policy of continuous improvement, SHARP reserves the right to make design and specification changes for the LCD TV set improvement without prior notice. The performance specification figures indicated are nominal values of production units. There may be some deviations from these values in individual units.



## Information for Customers on environmentally friendly disposal of this SHARP product

If this product cannot be used any more, it should be disposed of in a legally correct and environmentally sound way.

**DO NOT DISPOSE OF THIS PRODUCT WITH YOUR HOUSEHOLD WASTE  
OR MIXED WITH OTHER WASTES! YOU MIGHT ENDANGER THE ENVIRONMENT!**

Sharp Corporation is committed to protecting the environment and conserving energy. Our goal is to minimize the environmental impact of our products by continually implementing and improving product technologies, designs, and customer information aimed at environmental conservation.

### (1) For our customers in Belgium, The Netherlands, Sweden, and Switzerland

SHARP takes part in the respective national recycling systems for electronic equipment, which have been founded on the basis of the environmental laws in these countries.

Please see here details on the respective countries.

Country	Recycling Information for that Country
Sweden	Please use the Swedish electronics recycling system called "ELRETUR", and see the website at <a href="http://www.el-kretsen.se">http://www.el-kretsen.se</a>
The Netherlands	Please use the Dutch electronics recycling system called "ICT-Milieu", and see the website at <a href="http://www.nederlandict.nl/index.php">http://www.nederlandict.nl/index.php</a>
Belgium	Please use the Belgian electronics recycling system called "Recupel", and see the website at <a href="http://www.recupel.be">http://www.recupel.be</a>
Switzerland	Please use the Swiss electronics recycling system called "SWICO", and see the website at <a href="http://www.swico.ch">http://www.swico.ch</a>

### (2) For our customers in United Kingdom, Germany, France, and Italy

Please contact your local authorities for collection and recycling facilities, or contact a recycling service company, which is licensed for the recycling of electronic equipment.

#### IMPORTANT NOTE ON DISENGAGING ADVANCED CHILD LOCK

We suggest that you remove the following instruction from the operation manual to prevent children from reading it. As this operation manual is multilingual, we also suggest the same with each language. Keep it in a safe space for future reference. If you have forgotten your personal code number and cannot disengage ADVANCED CHILD LOCK, follow the procedure below.

1. Press **MENU** to display the Menu screen.
2. Press **◀▶** to select "Features".
3. Press **▲▼** to select "Child lock", and press **OK**.
4. The PIN input menu is displayed.
5. Input "3001" with **Channel Select**.

The Child lock setting menu is displayed.

ADVANCED CHILD LOCK will now be disengaged.

